

Generation of Delaney-Dress graphs

Nico Van Cleemput

Department Applied Mathematics, Computer Science and Statistics
 Ghent University
 Krijgslaan 281 - S9 - WE02
 9000 Ghent
 Belgium
 nico.vancleemput@gmail.com

February 26, 2020

Abstract

We introduce an algorithm for the efficient generation of cubic pregraphs which have a 2-factor in which each component is a quotient of C_4 . This class of pregraphs is of particular interest, since it corresponds to the class of uncoloured graphs that are the underlying graphs of Delaney-Dress graphs. We also extend the algorithm to generate Delaney-Dress graphs.

Keywords Delaney-Dress graph; cubic pregraph; symmetry type graph; isomorphism-free, exhaustive generation; closed structure

1 Introduction

A *pregraph* is a multigraph which can also contain loops and semi-edges. In this paper we will only consider connected pregraphs. A *quotient of C_4* is a graph isomorphic to one of the four graphs in Figure 1. A C_4^q -*factor* is a 2-factor in which each component is a quotient of C_4 . A *Delaney-Dress graph* is a 3-edge-coloured cubic pregraph in which the components with colours 0 and 2 form a C_4^q -factor. These graphs arise during the study of periodic tilings. In the context of maps, i.e., 2-cell embeddings of a connected graph in a closed surface, they are also called *symmetry type graphs*. They are obtained by the taking the quotient of the dual of the barycentric subdivision

of the tiling or the graph with the colour preserving automorphism group of that dual. See [5, 10, 11] for more details.

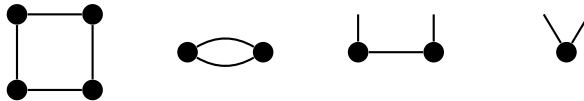

Figure 1: The four types of quotients of C_4 . From left to right: q_1 , q_2 , q_3 and q_4 .

In [10] an algorithm to generate different classes of cubic pregraphs is presented. That article also describes a filtering algorithm which can decide in linear time whether a pregraph has a C_4^q -factor. This class of pregraphs is of particular interest, since it corresponds to the class of uncoloured graphs that are the underlying graphs of Delaney-Dress graphs.

In [10], it is also noted that, although the filtering algorithm is efficient, a specialised algorithm for that class should be developed, since only a very small proportion of 3-edge-colourable pregraphs, i.e., the class most suited to filter the symmetry type graphs from, has this property. Once we reach 20 vertices already 99.98% of the graphs that are generated do not have a C_4^q -factor (see Table 1). Section 2 introduces such an algorithm. We also use this algorithm to go a step further, and also generate Delaney-Dress graphs.

Delaney-Dress graphs are of interest, since they encode information about the symmetries of a map. From the Delaney-Dress graph of a map, we can see whether the map is regular, transitive on either vertices, edges or faces, as well as several other properties [11]. Knowing which Delaney-Dress graphs exist, is therefore crucial when classifying maps. Delaney-Dress graphs also form the underlying structures for Delaney-Dress symbols which fully encode tilings together with their symmetry group. There are several examples of ad-hoc algorithms to generate specific types of Delaney-Dress symbols with applications in mathematics [3, 4] and in chemistry [5, 8]. An algorithm to generate Delaney-Dress graphs forms the basis for a general approach to this type of problems.

2 C_4^q -marked pregraphs

Definition 2.1 *A C_4^q -marked pregraph is a cubic pregraph in which all the edges of a given C_4^q -factor are coloured with colour 0 and all other edges with*

n	colourable	has C_4^q -factor	ratio
1	1	1	100.00 %
2	3	3	100.00 %
3	3	2	66.67%
4	11	9	81.82%
5	17	7	41.18%
6	59	29	49.15%
7	134	27	20.15%
8	462	105	22.73%
9	1 332	118	8.86%
10	4 774	392	8.21%
11	16 029	546	3.41%
12	60 562	1 722	2.84%
13	225 117	2 701	1.20%
14	898 619	7 953	0.89%
15	3 598 323	13 966	0.39%
16	15 128 797	40 035	0.26%
17	64 261 497	75 341	0.12%
18	283 239 174	210 763	0.07%
19	1 264 577 606	420 422	0.03%
20	5 817 868 002	1 162 192	0.02%

Table 1: Comparison of the number of 3-edge-colourable pregraphs on n vertices and the number of pregraphs with a C_4^q -factor on n vertices.



Figure 2: A barbed path has two different C_4^q -factors when its order is even and two isomorphic C_4^q -factors otherwise.

colour 1.

A C_4^q -markable pregraph is a cubic pregraph which has a C_4^q -factor.

Note that the colouring in a C_4^q -marked pregraph clearly is not a proper edge-colouring as each vertex is incident to two edges of colour 0. It is also clear that the underlying uncoloured graph of a C_4^q -marked pregraph is a pregraph which has a C_4^q -factor. The following theorem shows that for a given n for almost all C_4^q -markable pregraphs on n vertices there is a unique C_4^q -factor up to isomorphism.

First we repeat the definition of a few families of graphs that were already defined in [10] and also define some new families.

Given a pregraph P , a *ladder* in P is a maximal subgraph of P that is isomorphic to the graph cartesian product of K_2 and the path P_n with n vertices for some $n \geq 2$.

A *prism* is a graph that is isomorphic to the graph cartesian product of K_2 and C_n for some $n > 2$.

A *Möbius ladder* is a graph that is isomorphic to the graph on vertices $0, \dots, 2n - 1$ with vertex i adjacent to $(i - 1) \bmod 2n$, $(i + 1) \bmod 2n$ and $(i + n) \bmod 2n$ where $n > 1$.

A *crown* is a cycle with each vertex additionally incident to one semi-edge.

A *barbed path* is a path where the end points are additionally incident to two semi-edges, and all other vertices are additionally incident to one semi-edge. See Figure 2 for an example.

A *double-closed ladder* is a graph isomorphic to the graph cartesian product of K_2 and the path P_n with n vertices for some $n \geq 2$, with the vertices corresponding to the same end point of the path additionally connected by an extra edge. See Figure 3 for an example.

A *double-open ladder* is a graph isomorphic to the graph cartesian product of K_2 and the path P_n with n vertices for some $n \geq 2$, with each vertex

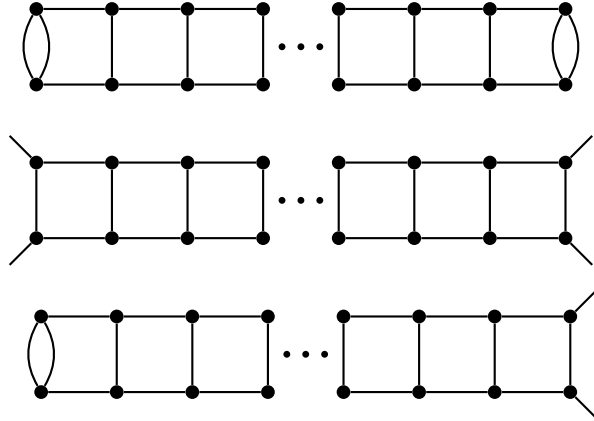

Figure 3: The three families of graphs containing ladders that have multiple non-isomorphic C_4^q -factors. From top to bottom: a double-closed ladder, a double-open ladder and an open-closed ladder.

corresponding to an end point of the path additionally incident to a semi-edge. See Figure 3 for an example.

An *open-closed ladder* is a graph isomorphic to the graph cartesian product of K_2 and the path P_n with n vertices for some $n \geq 2$, with the vertices corresponding to one end point of the path additionally connected by an extra edge, and the vertices corresponding to the other end point additionally incident to a semi-edge. See Figure 3 for an example.

Lemma 2.2 *A cubic pregraph P on at least 4 vertices has a unique partition into ladders, subgraphs induced by digons not contained in a ladder and the components of the subgraph induced by the complement of these.*

Proof: Since P is cubic, the intersection of two ladders in P , respectively of two digons in P , is empty. The definition of the partition does not allow a vertex to be in two different types of parts of the partition. This proves the lemma. ■

Theorem 2.3 *For each integer $n > 0$ the number of C_4^q -markable pregraphs on n vertices that have multiple pairwise non-isomorphic C_4^q -factors, depends only on $n \bmod 4$:*

- $n \bmod 2 \equiv 1$: 0 graphs
- $n \bmod 4 \equiv 0$: 4 graphs (the barbed path on n vertices, the double-closed ladder on n vertices, the double-open ladder on n vertices and the open-closed ladder on n vertices)
- $n \bmod 4 \equiv 2$: 2 graphs (the barbed path on n vertices and the open-closed ladder on n vertices)

Each C_4^q -markable pregraph has at most two non-isomorphic C_4^q -factors.

Proof: It is easily verified that the C_4^q -factor is unique for all C_4^q -markable pregraphs on 1 and 3 vertices and that there are exactly 2 C_4^q -markable pregraphs on 2 vertices that have 2 non-isomorphic C_4^q -factors.

A crown on $n \geq 4$ vertices is C_4^q -markable if n is even. A C_4^q -markable crown has two isomorphic C_4^q -factors, corresponding to the two 1-factors of the cycle.

A Möbius ladder on $n \geq 4$ vertices is C_4^q -markable if n is divisible by four. A Möbius ladder on four vertices has three isomorphic C_4^q -factors. A C_4^q -markable Möbius ladder on more than four vertices has two isomorphic C_4^q -factors.

A prism on $n \geq 4$ vertices is C_4^q -markable if n is divisible by four. A prism on four vertices does not exist. A prism on eight vertices is a cube. It is easily seen that a cube has three isomorphic C_4^q -factors: each C_4^q -factor corresponds to the edges of two opposite ‘faces’ of the cube when viewed as a solid. A C_4^q -markable prism on $n > 8$ vertices has two isomorphic C_4^q -factors.

Let P be a pregraph on $n \geq 4$ vertices which has a C_4^q -factor and is not a crown, Möbius ladder or prism. We will show that, except in a few cases, there is only one C_4^q -factor in P . Owing to Lemma 2.2, P has a unique partition into ladders, subgraphs induced by digons not contained in ladders and the components of the subgraph induced by the complement of these.

If P contains a digon that is not contained in a ladder, then at least one of the two vertices x and y of the digon is incident to an edge e that is not a semi-edge and that is not contained in the digon. Since e is not contained in a C_4 or a digon, and at least one of the vertices of e is not incident to a semi-edge, e can not be part of a quotient of C_4 , and so the original digon is part of the C_4^q -factor.

If P contains a ladder, then there are two possible situations. The first case is that there is a boundary vertex x of the ladder (a vertex not contained in an edge that is the intersection of two 4-cycles) that is incident to an edge e that is not a semi-edge and is not contained in a C_4 . Using a similar argumentation as with the digon, it is easy to see that e cannot be contained in a quotient of C_4 . This means that the C_4 which contains x is part of any C_4^q -factor of P . This also fixes any C_4^q -factor in this ladder. The second case is that the ladder contains all the vertices of P , but P is not a prism or a Möbius ladder. In this case we can look at the boundary vertices to determine the possible C_4^q -factors. Assume first that there are two boundary vertices which are connected by an edge e which is not contained in a C_4 or a digon. Again e cannot be contained in a quotient of C_4 and this implies that also in this case the C_4^q -factor is unique. There are still 3 graphs containing ladders which we have not discussed. These graphs are the double-closed ladder, the double-open ladder and the open-closed ladder.

Let us first consider the double-closed ladder. The edges at one side contained in a digon are in two ways contained in a quotient of C_4 : either the digon itself is the quotient, or one of the edges of the digon together with the rest of the C_4 in which it is contained is the quotient. In both cases the rest of the C_4^q -factor is unique for the whole graph. In case $n \bmod 4 \equiv 0$ this means that there are two non-isomorphic C_4^q -marked pregraphs, and in case $n \bmod 4 \equiv 2$ there are two isomorphic C_4^q -marked pregraphs.

Next we look at the double-open ladder. Again there are two ways the edges at one side can be contained in a C_4^q -factor and also in this case this means that there are two non-isomorphic C_4^q -marked pregraphs when $n \bmod 4 \equiv 0$ and two isomorphic C_4^q -marked pregraphs when $n \bmod 4 \equiv 2$.

Finally we have the open-closed ladder. Again the edges at one side contained in a digon are in two ways contained in a quotient of C_4 , but here these two C_4^q -factors are non-isomorphic for all n .

The C_4^q -factor is fixed in ladders and in digons that are not part of a ladder. The last step is to fix the C_4^q -factor in the rest of P . By definition a vertex in this remainder is not contained in a digon or a C_4 . So for any C_4^q -factor of P , all vertices in the remainder will be in components isomorphic to q_3 or q_4 . This implies that each vertex

in the remainder is incident to at least one semi-edge. Since P is not a crown, we find that this remainder consists of paths where each vertex is additionally also incident to at least one semi-edge. First assume that an end vertex x of such a path is incident to exactly one semi-edge. As we saw earlier, this implies that in P the vertex x is incident to an edge e that has a non-empty intersection with a digon or a ladder, and thus e cannot be contained in a quotient of C_4 . This again fixes the C_4^q -factor for the whole path and we find that there is a unique C_4^q -factor for P in this case.

So assume now that both end vertices are incident to exactly two semi-edges. This is only possible if P is a barbed path. If we look at one of the end vertices of P in this case, we see that this vertex is contained in a quotient of C_4 in two ways: either the two semi-edges are the quotient, or one of the two semi-edges, the third edge and the semi-edge at the neighbouring vertex are the quotient. Either choice fixes the C_4^q -factor for the whole graph. In case n is even, this means that there are two non-isomorphic C_4^q -factors in this pregraph, and in case n is odd, both C_4^q -factors are isomorphic. ■

Due to the previous theorem we can easily modify a generation algorithm for C_4^q -marked pregraphs to also generate pregraphs which have a C_4^q -factor. We just need to output the underlying graphs and make sure that we correctly handle the small number of graphs which lead to isomorphic unmarked pregraphs.

So let us look at how we can generate C_4^q -marked pregraphs. We start by refining the unique partition into subgraphs induced by ladders, subgraphs induced by digons not contained in ladders and the components of the subgraph induced by the complement of these. For C_4^q -marked pregraphs, we can refine this partition such that each part contains only one type of quotients of C_4 (see Figure 1).

Definition 2.4 *Given a C_4^q -marked pregraph P , a block partition of P is a partition of P into subgraphs of the following types:*

1. *maximal ladders containing only marked quotients of type q_1 ;*
2. *maximal subgraphs induced by marked quotients of type q_2 ;*
3. *maximal subgraphs induced by marked quotients of type q_3 ;*
4. *marked quotients of type q_4 .*

Such a partition is unique for each C_4^q -marked pregraph P .

The different subgraphs in a block partition are called blocks.

Figure 4 shows representatives of all possible maximal subgraphs induced by marked quotients of type q_1 . These blocks can be determined by starting from a ladder with an order that is divisible by four and adding edges between the vertices of degree 2 or adding a semi-edge to these vertices. This was done by a straightforward ad-hoc script, since no specialised techniques are needed for this small set of blocks. Figure 5, respectively Figure 6, shows representatives of all possible maximal subgraphs induced by marked quotients of type q_2 , respectively of type q_3 . Figure 7 shows all possible subgraphs induced by marked quotients of type q_4 .

We use block partitions to generate the C_4^q -marked pregraphs. This generation process happens in several phases. To generate all the C_4^q -marked pregraphs with n vertices, we start by generating all lists of blocks such that the sum of the orders of the blocks is equal to n . This is done by a simple orderly algorithm without many optimisations since the time spent in the generation of these lists is negligible compared to the rest of the generation process. Since each C_4^q -marked pregraph corresponds to exactly one such list of blocks, different lists will result in different C_4^q -marked pregraphs.

We can perform a few tests to discard lists that are not realisable as a block partition of a C_4^q -marked pregraph. We can view a C_4^q -marked pregraph with a block partition as a multigraph: the vertices of the multigraph are the blocks of the block partition, the edges of the multigraph are the edges between the blocks. This means that when we have a list of blocks we can check whether the degree sequence that corresponds to that list is realisable as a multigraph without loops. We use the characterisation by Owens and Trent [1] to check whether a degree sequence is realisable as a loopless multigraph.

Not all lists for which the corresponding degree sequences are realisable will occur as block partition of a C_4^q -markable pregraph. Another restriction we need to take into account when connecting the blocks is that not every connection is valid. A condition for the unicity of the block partition was that the blocks were maximal. This means that connecting a q_2 block to a q_2 block or a q_3 block to a q_3 block is not allowed. Neither is it allowed to connect two q_1 blocks such that two of the connecting edges are part of a C_4 . So we can add the following test to discard some more blocks: if more than half of the connections are connections at q_2 blocks or more than half of the connections are connections at q_3 blocks, then this list will not be realisable.

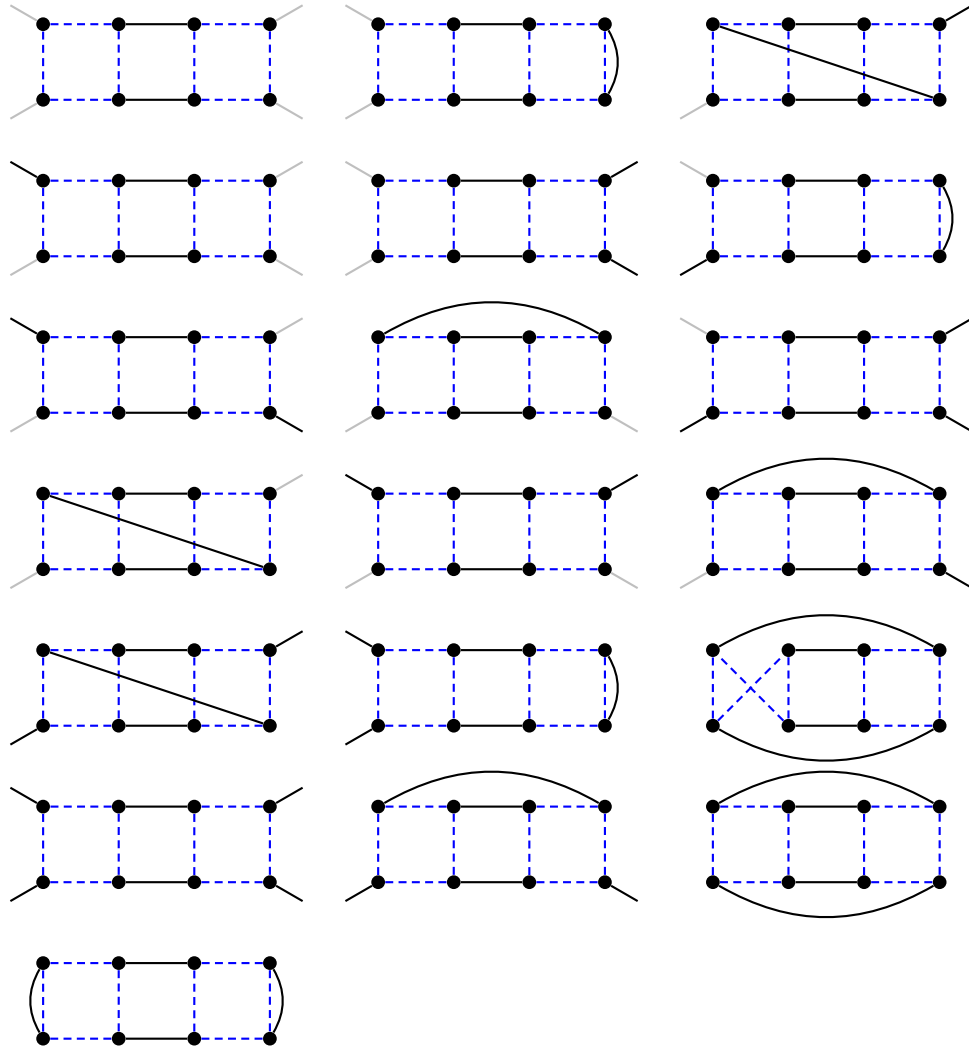

Figure 4: Representatives of all possible maximal ladders containing only marked quotients of type q_1 . The dashed lines are the marked quotients of type q_1 and the grey lines are the edges that go to different blocks.

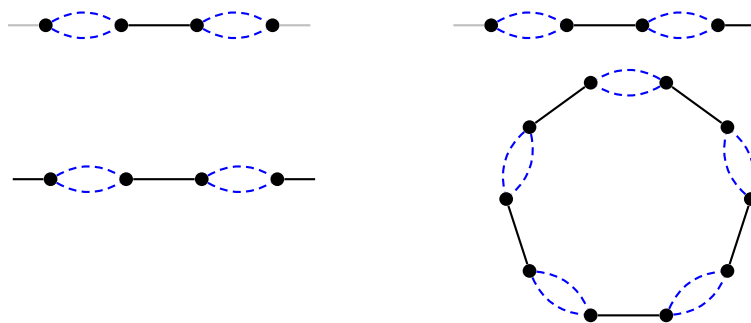

Figure 5: Representatives of all possible maximal subgraphs induced by marked quotients of type q_2 . The dashed lines are the marked quotients of type q_2 and the grey lines are the edges that go to different blocks.

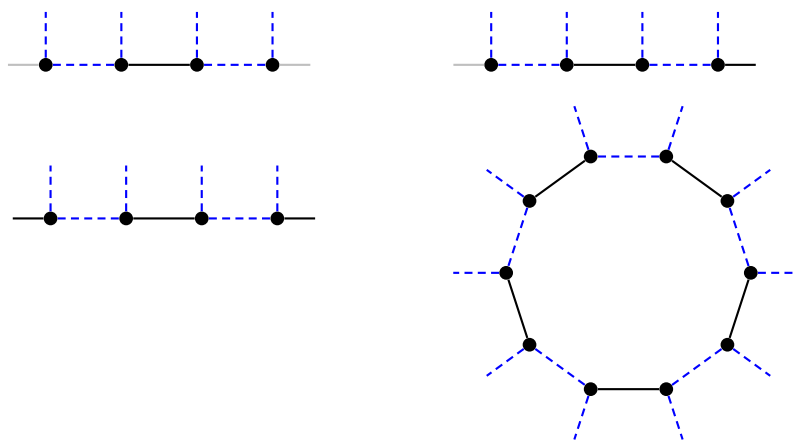

Figure 6: Representatives of all possible maximal subgraphs induced by marked quotients of type q_3 . The dashed lines are the marked quotients of type q_3 and the grey lines are the edges that go to different blocks.



Figure 7: All possible subgraphs induced by marked quotients of type q_4 . The dashed lines are the marked quotients of type q_4 and the grey lines are the edges that go to different blocks.

A list L of blocks is *acceptable* if and only if

- the degree sequence corresponding to L is multigraphic,
- half or less than half of the missing connections lie in q_2 blocks, and
- half or less than half of the missing connections lie in q_3 blocks.

Once we have a list we need to try and add the connections in all possible ways.

Definition 2.5 A partial C_4^q -marked pregraph is a not necessarily connected pregraph P in which all the edges of a given C_4^q -factor are coloured with colour 0 and all other edges with colour 1 and where all vertices have either degree 2 or degree 3.

The vertices with degree 2 are called the deficient vertices of P .

Definition 2.6 Denote by $B(P)$ the block list corresponding to the unique block partition of P .

Given a block list L , denote by \mathcal{B}_L the set of partial C_4^q -marked pregraphs with a block partition isomorphic to L .

A block list corresponds in a trivial way to a partial C_4^q -marked pregraph. We construct a new partial C_4^q -marked pregraph by connecting two deficient vertices. The new partial C_4^q -marked pregraph has two deficient vertices less than the original graph. Once we have a partial C_4^q -marked pregraph with no deficient vertices we have found a C_4^q -marked pregraph. To generate the C_4^q -marked pregraphs we use the principle of closed structures [7, 9].

Definition 2.7 A marked subgraph of a partial C_4^q -marked pregraph P is a subgraph P_s of P such that P_s is a partial C_4^q -marked pregraph and the colours of the edges in P_s is the same as the colours of the edges in P .

A partial C_4^q -marked pregraph P' is an extension of a partial C_4^q -marked pregraph P if P is a marked subgraph of P' , and P' and P have the same number of vertices.

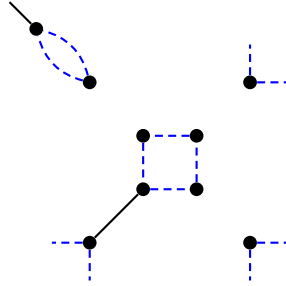

Figure 8: A partial C_4^q -marked pregraph that is not closed.

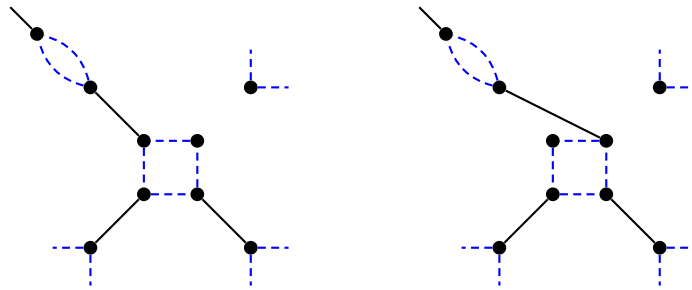

Figure 9: Two extensions of the partial C_4^q -marked pregraph in Figure 8 which are isomorphic but for which the isomorphism does not induce an automorphism of the original partial C_4^q -marked pregraph.

A partial C_4^q -marked pregraph P is closed if for any two extensions P_1 and P_2 of P we have that any isomorphism between P_1 and P_2 induces an automorphism of P .

The partial C_4^q -marked pregraph P in Figure 8 is not closed since the two extensions in Figure 9 are isomorphic, but the isomorphism maps the vertex in the bottom right to the vertex in the bottom left and vice versa. Clearly this does not induce an automorphism of P since these vertices have different degrees in P .

The partial C_4^q -marked pregraph corresponding to a block list L is a closed partial C_4^q -marked pregraph since any connection that would create a subgraph that is a block leads to a partial C_4^q -marked pregraph that is not in \mathcal{B}_L .

The advantage of this technique with closed structures is that if the closed partial C_4^q -marked pregraph P has a trivial symmetry group, no two

different extensions of P will be isomorphic, and so no isomorphism rejection is needed once a closed graph with trivial symmetry appears in the generation process. Clearly we want to reach such a closed partial C_4^q -marked pregraph as soon as possible during the generation. The following lemma shows a way how a new closed partial C_4^q -marked pregraph can be obtained when starting with a closed partial C_4^q -marked pregraph.

Lemma 2.8 *Let P be a closed partial C_4^q -marked pregraph. Let O be an orbit of deficient vertices under the automorphism group of P . Let P' be an extension of P so that no vertex from O is deficient and no edges in $P' \setminus P$ have an empty intersection with O . Then P' is also a closed partial C_4^q -marked pregraph.*

Proof: Assume we have two extensions P'_1 and P'_2 of P' . We need to prove that if there is an isomorphism σ between P'_1 and P'_2 , this isomorphism induces an automorphism of P' . Since P is closed, we have that σ induces an automorphism of P .

Assume that there is an isomorphism $\sigma : P'_1 \rightarrow P'_2$ that does not induce an automorphism of P' . So there exist vertices x, y in P' , such that x and y are adjacent in P' , and $\sigma(x)$ and $\sigma(y)$ are not adjacent in P' . As P is a subgraph of P' , it cannot be that $\sigma(x)$ and $\sigma(y)$ are adjacent in P , so we have that x and y are non-adjacent in P . This means at least one of the two vertices x and y belongs to O , so assume that $x \in O$. As σ induces an automorphism on P , this means that $\sigma(x) \in O$ and so in P' $\sigma(x)$ is adjacent to another vertex, say z . Since x is adjacent to y in P'_1 , $\sigma(x)$ is adjacent to $\sigma(y)$ in P'_2 , but this contradicts that $\sigma(x)$ is not a deficient vertex in P' .

So we find that for any two extensions P'_1 and P'_2 , there is no isomorphism between P'_1 and P'_2 that does not induce an automorphism of P' and thus P' is a closed partial C_4^q -marked pregraph. ■

We want to go from closed partial C_4^q -marked pregraphs to closed partial C_4^q -marked pregraphs as ‘fast’ as possible, that is why we will each time select the smallest orbit of deficient vertices and add connections to that orbit. Once we find a partial C_4^q -marked pregraph with a trivial symmetry, we can stop any isomorphism rejections and just add the remaining connections in all possible ways. We can even do this a bit sooner: it is sufficient that the symmetry group acts trivially on the deficient vertices.

Theorem 2.9 *Let P be a closed partial C_4^q -marked pregraph. If the automorphism group of P acts trivially on the deficient vertices of P , then all extensions of P are pairwise non-isomorphic.*

Proof: Let P_1 and P_2 be two different extensions of P . Assume that there is an isomorphism σ between P_1 and P_2 . Since P is closed, the isomorphism σ induces an automorphism of P . Let e be an edge in $P_1 \setminus P$. Both vertices incident to e are deficient vertices in P , and so they are fixed by σ . This implies that the edge e is fixed by σ , so we find that all edges in $P_1 \setminus P$ are fixed by σ , which contradicts that P_1 and P_2 are different extensions. ■

In summary, we use the following algorithm to generate the C_4^q -marked pregraphs with n vertices:

1. Generate all acceptable lists of blocks such that the sum of the orders of the blocks is n .
2. For each list construct the corresponding partial C_4^q -marked pregraph P and recursively repeat the following steps :
 - (a) If P has no deficient vertices: output P and return.
 - (b) Compute the automorphism group of P and compute the orbits of deficient vertices of P .
 - (c) If $Aut(P)$ acts trivial on the set of deficient vertices of P , then complete P by adding the remaining connections in all possible valid ways and output any complete C_4^q -marked pregraph obtained this way.
 - (d) Otherwise choose the smallest orbit O and connect all vertices in O to deficient vertices in all valid ways that give non-isomorphic partial C_4^q -marked pregraph and repeat these steps for this new partial C_4^q -marked pregraph.

The fact that this algorithm moves from closed partial C_4^q -marked pregraph to closed partial C_4^q -marked pregraph is not sufficient to guarantee that no pairwise isomorphic structures are output. Although all extensions of a closed partial C_4^q -marked pregraph are pairwise non-isomorphic, it might still be possible that they are isomorphic to extensions of another partial C_4^q -marked pregraph. That this is not the case still needs to be proven.

Definition 2.10 A partial C_4^q -marked pregraph P is strongly closed in a set S of partial C_4^q -marked pregraphs, if all partial C_4^q -marked pregraphs in S that contain a subgraph isomorphic to P are extensions of P .

Lemma 2.11 Let L be the block list under consideration in Step 2 in the algorithm above. The partial C_4^q -marked pregraphs to which the recursive step is applied, are strongly closed in \mathcal{B}_L .

Proof: Due to Lemma 2.8, the graphs to which the recursive step is applied are closed. It is also clear that the initial partial C_4^q -marked pregraph that corresponds to the block list L without connections is strongly closed in the set \mathcal{B}_L .

What remains to be proven is that if a partial C_4^q -marked pregraph P is strongly closed in $\mathcal{B}_{B(P)}$, O is an orbit of deficient vertices of P under the automorphism group of P and P' is an extension of P such that all vertices in O are no longer deficient and no edges were added that have an empty intersection with O , then P' is also strongly closed in $\mathcal{B}_{B(P)}$.

Given a partial C_4^q -marked pregraph P'' such that $B(P'') = B(P)$ and that P'' contains a subgraph P'_s that is isomorphic to P' . As P' is an extension of P , P'_s also contains a subgraph that is isomorphic to P , and thus P'_s is an extension of P . Since P is closed, we have that the isomorphism between P'_s and P' induces an automorphism of P . Since O is an orbit under the automorphism group of P , O is mapped onto O . This means that both P' and P'_s are extensions of P and for both partial C_4^q -marked pregraphs the same orbit of deficient vertices was chosen in step 2d of the algorithm above. In step 2d only pairwise non-isomorphic partial C_4^q -marked pregraphs are generated, so we find that $P' = P'_s$. So we have that P'' is an extension of P' , which proves that P' is strongly closed in $\mathcal{B}_{B(P)}$. ■

Theorem 2.12 The algorithm above outputs exactly one representative of every isomorphism class of C_4^q -marked pregraph with n vertices.

Proof: This theorem follows from Lemma 2.8 and Lemma 2.11, together with the fact that each C_4^q -marked pregraph has a unique block partition. ■

When we construct the partial C_4^q -marked pregraph P corresponding to a list we also construct the automorphism group of P , i.e., we construct a set of generators for the automorphism group based upon the automorphisms of the blocks and the isomorphism of similar blocks. For further computations of the automorphism group we use the program *nauty* [2].

For step 2d we use McKay's canonical construction path method [6]. Given a partial C_4^q -marked pregraph P and an orbit O of deficient vertices, we first calculate the orbits of unordered pairs of deficient vertices $\{x, y\}$ such that $\{x, y\} \cap O$ is not empty. For each orbit of unordered pairs we choose one pair in that orbit and connect these vertices if this is a valid connection. There are two reasons why a connection could be invalid: it might create a new block, or it might create a subgraph which does not contain all the vertices and does not contain any deficient vertices. In case this is a valid connection, we still need to verify that it is the canonical operation to obtain the resulting partial C_4^q -marked pregraph P' . This is done by labelling each vertex v with a 2-tuple (x_1, x_2) . In this tuple x_1 is the label of v in a canonical labelling of P and x_2 is the label of v in a canonical labelling of P' . This operation is accepted if and only if the new connection is in the orbit of connections in P' which have a non-empty intersection with O and for which the vertices have the lexicographically smallest vertex labels. It is often not needed to construct a canonical labelling of P' , since the operation can already be discarded as being not canonical based on the values of x_1 for the vertices.

3 Delaney-Dress graphs

Given a Delaney-Dress graph G we can easily construct a C_4^q -marked pregraph P from G by marking the edges with colour 0 and colour 2 and then removing all original colours. When we want to generate Delaney-Dress graphs from C_4^q -marked pregraphs, then we want to go in the other direction, i.e., we need to assign colours 0 and 2 to the marked quotients of C_4 in the C_4^q -marked pregraph. Clearly the construction above leads to a unique C_4^q -marked pregraph corresponding to a Delaney-Dress graph, and so different C_4^q -marked pregraphs will lead to different Delaney-Dress graphs.

We need to check that different colour assignments do not lead to isomorphic Delaney-Dress graphs. In the cases where this does happen, we only accept one of these isomorphic copies.

A first observation we can make is that if we swap the colours in a quotient of type q_2 or in a quotient of type q_4 , we always get an isomorphic

Delaney-Dress graph. We indeed always have the isomorphism that fixes all the vertices and all the edges that are not in that quotient and that interchanges the two edges, resp. semi-edges, in that quotient. This means that we can just choose an arbitrary colouring for these quotients and can focus the isomorphism rejection on the quotients of type q_1 and the quotients of type q_3 .

Given a partially coloured Delaney-Dress graph D such that the uncoloured subgraphs are quotients of type q_1 and of type q_3 , the set of uncoloured quotients is denoted by U . Note that if n is the number of vertices in D , then U contains at most $\frac{n}{2}$ elements and in most cases it will be much less than that. We can define a bijection between the set of valid colour assignments for D and the set of binary vectors with length $|U|$. We start by choosing a matching (i.e., two non-adjacent edges) in each quotient of type q_1 . For a quotient u of type q_1 we denote this matching by $m(u)$. We also label the quotients in U with the numbers 1 to $|U|$.

A colouring c is mapped to a binary vector v_c as follows. The i th coordinate of v_c corresponds to the uncoloured quotient $u \in U$ that has label i . If u is of type q_1 , then the i th coordinate of v_c is equal to 0 if the edges in $m(u)$ receive colour 0, and is equal to 1 if these edges receive colour 2. If u is of type q_3 , then the i th coordinate of v_c is equal to 0 if the semi-edges in u receive colour 0, and is equal to 0 otherwise.

Given an automorphism σ of D and a binary vector v_c corresponding to a colouring c , we can easily construct the binary vector v'_c that corresponds to the colouring c' of D when we would apply σ to the coloured Delaney-Dress graph. The automorphism σ will map a quotient $u \in U$ to another quotient $u' \in U$, and clearly u and u' will be of the same type. If for each vertex the factor in which it is contained is known, it is sufficient to know the image of one vertex of u to determine u' . In case u is of type q_3 , then the coordinate in v'_c corresponding to u' will have the same value as the coordinate in v_c corresponding to u . In case u is of type q_1 , then we need to check whether $m(u)$ is mapped to $m(u')$ by σ . (For this it is sufficient to know the image of one edge of $m(u)$.) If this is the case, then the coordinate in v'_c corresponding to u' will have the same value as the coordinate in v_c corresponding to u . Otherwise they will have different values.

This means that we can perform the orbit calculations on the set of binary vectors. We use the *union-find* algorithm on the set of all binary vectors with length $|U|$ to find which coloured Delaney-Dress graphs are isomorphic.

4 Testing

Small errors are always easily made in both mathematical proofs and computer programs. In computer programs however, they are often more concealed and less subject to scrupulous checking. It is therefore important to perform tests of the computer programs. Preferably using independently written programs based on different algorithms.

The numbers of C_4^q -markable pregraphs up to 20 vertices have been compared to the numbers obtained in [10]. Since the techniques used in both cases are very different this offers an independent test for the implementation. The program used in [10] had already itself been compared to manual results.

The numbers of Delaney-Dress graphs up to $n = 10$ vertices have been compared to the results obtained in [11].

5 Results

The algorithms described in this article have been implemented in C as the program `ddgraphs`. It is available at [12].

Table 2 gives an overview of the numbers of block lists, the numbers of C_4^q -marked pregraphs and the numbers of C_4^q -markable pregraphs on up to $n = 35$ vertices.

Table 3 shows an overview of the numbers of Delaney-Dress graphs on up to $n = 35$ vertices.

The numbers for graphs on more than 30 vertices were obtained by splitting the generation in several parts. This was done by generating the block lists and distributing which block lists needed to be extended. Since the generation of the block lists is negligible compared to the remaining generation process, this splitting in parts can be done very efficiently.

Table 2: An overview of the number of block lists, the number of C_4^q -marked pregraphs and the number of C_4^q -markable pregraphs with n vertices. For each column the time needed to generate those structures using the program `ddgraphs` is given. For the C_4^q -markable pregraphs also the time needed by `pregraphs` is given [10]. All timings were done on a 2.40 GHz Intel Xeon.

n	lists	time ddgraphs	C_4^q -marked	time ddgraphs	C_4^q -markable	time ddgraphs	time pregraphs
1	1	0.0s	1	0.0s	1	0.0s	0.0s
2	5	0.0s	5	0.0s	3	0.0s	0.0s
3	2	0.0s	2	0.0s	2	0.0s	0.0s
4	13	0.0s	13	0.0s	9	0.0s	0.0s
5	7	0.0s	7	0.0s	7	0.0s	0.0s
6	31	0.0s	31	0.0s	29	0.0s	0.0s
7	25	0.0s	27	0.0s	27	0.0s	0.0s
8	103	0.0s	109	0.0s	105	0.0s	0.0s
9	86	0.0s	118	0.0s	118	0.0s	0.0s
10	311	0.0s	394	0.0s	392	0.0s	0.1s
11	260	0.0s	546	0.0s	546	0.0s	0.3s
12	938	0.0s	1 726	0.0s	1 722	0.1s	1.3s
13	763	0.0s	2 701	0.1s	2 701	0.1s	5.2s
14	2 521	0.0s	7 955	0.3s	7 953	0.3s	22.0s
15	1 968	0.0s	13 966	0.4s	13 966	0.4s	94.8s
16	6 776	0.0s	40 039	1.4s	40 035	1.5s	\approx 7.0m
17	5 171	0.0s	75 341	2.3s	75 341	2.2s	\approx 31.7m

Continued on next page

Table 2: An overview of the number of block lists, the number of C_4^q -marked pregraphs and the number of C_4^q -markable pregraphs with n vertices. (Continued)

n	lists	time ddgraphs	C_4^q -marked	time ddgraphs	C_4^q -markable	time ddgraphs	time pregraphs
18	16 557	0.0s	210 765	8.1s	210 763	8.0s	≈ 2.5 h
19	12 321	0.0s	420 422	13.9s	420 422	14.0s	≈ 11.6 h
20	40 622	0.1s	1 162 196	46.5s	1 162 192	46.6s	≈ 56.0 h
21	29 843	0.1s	2 419 060	86.8s	2 419 060	86.7s	
22	93 166	0.2s	6 626 610	≈ 4.6 m	6 626 608	≈ 4.6 m	
23	67 345	0.2s	14 292 180	≈ 9.2 m	14 292 180	≈ 9.2 m	
24	213 822	0.5s	38 958 571	≈ 28.2 m	38 958 567	≈ 28.4 m	
25	153 388	0.5s	86 488 183	≈ 59.7 m	86 488 183	≈ 59.8 m	
26	467 050	1.2s	235 004 260	≈ 3.0 h	235 004 258	≈ 3.0 h	
27	331 411	1.2s	534 796 010	≈ 6.6 h	534 796 010	≈ 6.6 h	
28	1 018 009	3.0s	1 450 990 715	≈ 19.2 h	1 450 990 711	≈ 19.2 h	
29	719 250	2.9s	3 373 088 492	≈ 43.7 h	3 373 088 492	≈ 43.7 h	
30	2 136 996	6.8s	9 147 869 420	≈ 5.3 days	9 147 869 418	≈ 5.3 days	
31	1 498 823	6.5s	21 667 784 040	≈ 12.5 days	21 667 784 040	≈ 12.5 days	
32	4 468 381	16.1s	58 791 212 723	≈ 36.0 days	58 791 212 719	≈ 36.1 days	
33	3 126 211	15.4s	141 583 919 924	≈ 86.2 days	141 583 919 924	≈ 86.3 days	
34	9 071 315	34.5s	384 597 958 574	≈ 246.2 days	384 597 958 572	≈ 246.4 days	
35	6 316 138	33.1s	940 092 232 951	≈ 600.6 days	940 092 232 951	≈ 601.1 days	

References

- [1] B. Owens and H.M. Trent. On determining minimal singularities for the realization of an incidence sequence. *SIAM Journal on Applied Mathematics*, 15:406–418, 1967.
- [2] B. D. McKay. Practical graph isomorphism. *Congressus Numerantium*, 30:45–87, 1981.
- [3] A. Dress and R. Scharlau. The 37 combinatorial types of minimal non-transitive, equivariant tilings of the euclidean plane. *Discrete Mathematics*, 60:121–138, 1986.
- [4] A. Dress and D. Huson. On tilings of the plane. *Geometriae Dedicata*, 24:295–310, 1987.
- [5] A. Dress and G. Brinkmann. Phantasmagorical fulleroids. *MATCH Commun. Math. Comput. Chem.*, 33:87–100, 1996. P.W. Fowler ed.: Mathematical aspects of the fullerenes.
- [6] B. D. McKay. Isomorph-free exhaustive generation. *Journal of Algorithms*, 26:306–324, 1998.
- [7] G. Brinkmann. Generating water clusters and other directed graphs. *J. Math. Chem.*, 46:1112–1121, 2009.
- [8] G. Brinkmann, O. Delgado-Friedrichs, E. C. Kirby, and N. Van Cleemput. A Catalogue of Periodic Fully-Resonant Azulene-Transitive Azulenoid Tilings Analogous to Clar Structures. *Croatica Chemica Acta*, 82(4):781–789, 2009.
- [9] G. Brinkmann. Generating regular directed graphs. *Discrete Mathematics*, 313(1):1–7, 2013.
- [10] G. Brinkmann, N. Van Cleemput, and T. Pisanski. Generation of various classes of trivalent graphs. *Theoretical Computer Science*, 502:16–29, 2013.
- [11] I. Hubard, A. Orbanić, T. Pisanski, and M. del Río Francos. Medial symmetry type graphs. *Electronic J. Combin.*, 20(3), #P29, 2013.
- [12] ddgraphs website. <http://caagt.ugent.be/ddgraphs>.

n	Delaney-Dress graphs	time	rate
1	1	0.0s	
2	7	0.0s	
3	3	0.0s	
4	22	0.0s	
5	13	0.0s	
6	70	0.0s	
7	67	0.0s	
8	315	0.0s	
9	393	0.0s	
10	1 577	0.0s	
11	2 515	0.0s	
12	9 480	0.1s	94 800.00/s
13	17 205	0.1s	172 050.00/s
14	61 594	0.3s	205 313.33/s
15	123 953	0.4s	309 882.50/s
16	433 030	1.6s	270 643.75/s
17	931 729	2.5s	372 691.60/s
18	3 196 841	9.1s	351 301.21/s
19	7 258 011	16.3s	445 276.75/s
20	24 630 262	55.0s	447 822.95/s
21	58 309 071	105.9s	550 605.01/s
22	196 266 434	≈ 5.8 m	568 064.93/s
23	481 330 615	≈ 12.0 m	666 478.28/s
24	1 610 942 856	≈ 38.8 m	691 629.25/s
25	4 071 117 829	≈ 1.4 h	785 187.34/s
26	13 569 014 653	≈ 4.6 h	826 265.50/s
27	35 202 390 477	≈ 10.6 h	919 758.85/s
28	116 994 675 348	≈ 33.8 h	960 576.60/s
29	310 624 700 725	≈ 3.4 days	1 049 801.45/s
30	1 030 455 432 427	≈ 11.0 days	1 084 892.06/s
31	2 792 944 867 743	≈ 27.4 days	1 177 978.85/s
32	9 256 071 637 206	≈ 88.8 days	1 205 812.64/s
33	25 557 439 215 047	≈ 231.9 days	1 275 360.82/s
34	84 676 700 443 607	≈ 2.1 years	1 297 545.26/s
35	237 766 612 990 437	≈ 5.6 years	1 353 707.99/s

Table 3: An overview of the number of Delaney-Dress graphs and the time needed by `ddgraphs` to generate these graphs when run on a 2.40 GHz Intel Xeon.