

Structure and substructure fault tolerance of hypercubes

Yihan Chen*, Bicheng Zhang*

School of Mathematics and Computational Science, Xiangtan University, Xiangtan, Hunan, 411105, PR China

Abstract

Hypercube is one of the most important networks to interconnect processors in multiprocessor computer systems. Different kinds of connectivities are important parameters to measure the fault tolerability of networks. Lin et al.[4] introduced the concept of H -structure connectivity $\kappa(Q_n; H)$ (resp. H -substructure connectivity $\kappa^s(Q_n; H)$) as the minimum cardinality of $F = \{H_1, \dots, H_m\}$ such that $H_i (i = 1, \dots, m)$ is isomorphic to H (resp. $F = \{H'_1, \dots, H'_m\}$ such that $H'_i (i = 1, \dots, m)$ is isomorphic to connected subgraphs of H) such that $Q_n - V(F)$ is disconnected or trivial. In this paper, we discuss $\kappa(Q_n; H)$ and $\kappa^s(Q_n; H)$ for hypercubes Q_n with $n \geq 3$ and $H \in \{P_k, C_k | 3 \leq k \leq 2^{n-1}\}$. As a by-product, we solve the problem mentioned in [5].

Keywords: Structure connectivity; Substructure connectivity; Hypercubes; Path; Cycle

1. Introduction

In the design of multiprocessor computer systems, the analysis of topological properties of interconnection networks is very important. Usually, an efficient interconnection topology can offer higher speed and better quality of information transmission between processors, most importantly, it can also provide high fault tolerability.

Many regular networks have been proposed as the model to interconnect processors, such as hypercube, mesh and twiced cube etc. In the past, people used vertex connectivity to measure the fault tolerability of interconnect networks, their works focus on the effect of individual processors becoming fault. People soon discovered that there were some shortcomings in the using of vertex connectivity, in order to make up for these shortcomings, Harary defined the conditional connectivity. Later, many people generalized vertex connectivity in various ways and got many benefits, for example, restricted connectivity, g -extra connectivity and R_g -connectivity

*Corresponding author

Email addresses: 2016750518@smail.xtu.edu.cn (Yihan Chen), zhangbicheng@xtu.edu.cn (Bicheng Zhang)

etc.

Lin et al.[4] introduced the concept of H -structure connectivity $\kappa(Q_n; H)$ and the H -substructure connectivity $\kappa^s(Q_n; H)$ and determined them for $H \in \{K_1, K_{1,1}, K_{1,2}, K_{1,3}, C_4\}$. Li et al.[3] determined $\kappa(H_n; T)$ and $\kappa^s(H_n; T)$ with H_n the twisted hypercube and $T \in \{K_{1,r}, P_k | r = 3, 4 \text{ and } 1 \leq k \leq n\}$. Mane [5] proved that if $n \geq 4$ then for each $2 \leq m \leq n - 2$, $\kappa(Q_n; C_{2^m}) \leq n - m$ and leaved a question: For $n \geq 4$ and for each $2 \leq m \leq n - 2$, can we prove $\kappa(Q_n; C_{2^m}) = n - m$?

In this paper, we discuss $\kappa(Q_n; H)$ and $\kappa^s(Q_n; H)$ for hypercubes Q_n with $n \geq 3$ and $H \in \{P_k, C_k | 3 \leq k \leq 2^{n-1}\}$. As a by-product, we solve the problem above.

The rest of this paper is organized as follows. In *Section 2.* we give the fundamental definitions and theorems. In *Section 3.* we discuss $\kappa(Q_n; P_k)$ and $\kappa^s(Q_n; P_k)$ for hypercubes Q_n with $n \geq 3$ and $3 \leq k \leq 2^{n-1}$. In *Section 4.* we discuss $\kappa(Q_n; C_k)$ and $\kappa^s(Q_n; C_k)$ for hypercubes Q_n with $n \geq 3$ and $4 \leq k \leq 2^{n-1}$, k is even, and show the answer of the problem above.

2. Definitions and preliminaries

We are consistent with [2] in terms of notations and definitions. Let $G(V, E)$ be an undirected simple graph with vertex set V and edge set E , two vertices u and v are *adjacent* if and only if they are two endpoints of some edge $\phi(u, v)$ in E . Let S be a subset of V , we denote $N_G(S)$ the set of neighborhoods of S , particularly $N_G(\{u\}) = N_G(u)$ is the set of neighborhoods of u . In graph theory, a *path* of length k is a sequence of distinct vertices $P_k = (v_0, v_1, \dots, v_{k-1})$ in which $\phi(v_i, v_{i+1}) \in E$ for $i = 0, 1, \dots, k - 2$. A *cycle* of length l is a sequence of vertices $C_l = (v_0, v_1, \dots, v_l)$ in which $v_0 = v_l$ and v_i are distinct with $\phi(v_i, v_{i+1}) \in E$ for $i = 0, 1, \dots, l - 1$. An undirected graph $G(V, E)$ is said to be *connected* if and only if it has at least one vertex and there is a path between every pair of its vertices.

A n -dimensional hypercube Q_n is an undirected simple graph with vertex set $V(Q_n) = \{v = x_v^0 x_v^1 \dots x_v^{n-1} \mid x_v^i = 0 \text{ or } 1, i = 0, \dots, n - 1\}$ and edge set $E(Q_n)$. Two vertices are adjacent if and only if the n -bit binary strings corresponding to them are differ in exactly one bit position. Let v be a vertex of Q_n , we denote $(v)^i$ the neighborhood of v whose n -bit binary string is differ from v 's in exactly the i^{th} bit position for $i = 0, 1, \dots, n - 1$. We notice that Q_n has 2^n vertices and $n2^{n-1}$ edges, and it can be divided into two $n - 1$ -dimensional hypercubes. We set Q_n^i the subgraph of Q_n with vertex set $V(Q_n^i) = \{v \mid v \in V(Q_n), x_v^{n-1} = i\}$ for $i = 0, 1$. It is easy to see that Q_n^i is isomorphic to Q_{n-1} .

In the following, let's introduce some necessary definitions about the *structure and substructure*

ture connectivity, let H and G be undirected simple graph, H is connected.

Definition 2.1. A H -structure cut (resp. H -substructure cut) of G is a set F of connected subgraphs of G whose elements are isomorphic to H (resp. connected subgraph of H) and $G - V(F)$ is trivial or disconnected.

Now let's have two figures to help understand.

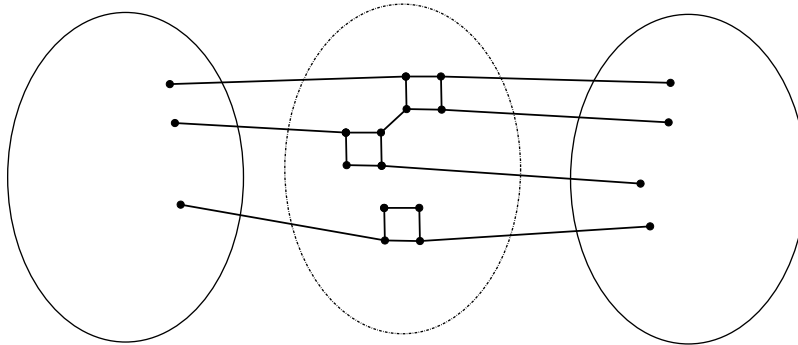

Fig 1. A C_4 -structure cut

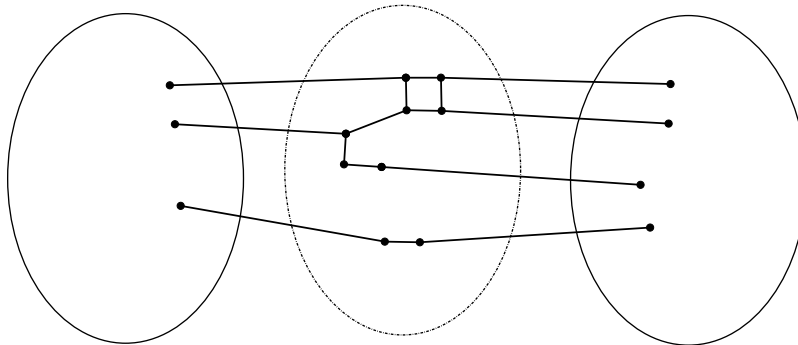

Fig 2. A C_4 -substructure cut

Definition 2.2. The H -structure connectivity (resp. H -substructure connectivity) denote by $\kappa(G; H)$ (resp. $\kappa^s(G; H)$) is the minimum cardinality of H -structure cuts (resp. H -substructure cuts).

Definition 2.3. (See [8]) Given a non-negative integer g , g -extra connectivity of G denote by $\kappa_g(G)$ is the minimum cardinality of sets of vertices in G whose deletion disconnects G and leaves each components with at least $g + 1$ vertices.

Lemma 2.4. Any two vertices in $V(Q_n)$ with a distance of 2 have exactly 2 common neighborhoods.

Proof. According to the symmetry of the hypercube Q_n , without loss of generality we assume that the two vertices are $u = 000 \dots 0$ and $v = 110 \dots 0$, obviously their common neighborhoods are $u' = 100 \dots 0$ and $v' = 010 \dots 0$. \square

Theorem 2.5. (See [7]) If $n \geq 4$, then $\kappa_g(Q_n) = (g + 1)n - 2g - \binom{g}{2}$ for $0 \leq g \leq n - 4$, and $\kappa_g(Q_n) = \frac{n(n-1)}{2}$ for $n - 3 \leq g \leq n$.

Theorem 2.6. (See [4]) For $n \geq 4$

$$\kappa(Q_n; H) = \begin{cases} n & H = K_1, \\ n - 1 & H = K_{1,1}, \\ \lceil \frac{n}{2} \rceil & H \in \{K_{1,2}, K_{1,3}\}, \\ n - 2 & H = C_4. \end{cases} \quad (2.1)$$

$$\kappa^s(Q_n; H) = \begin{cases} n & H = K_1, \\ n - 1 & H = K_{1,1}, \\ \lceil \frac{n}{2} \rceil & H \in \{K_{1,2}, K_{1,3}, C_4\}. \end{cases} \quad (2.2)$$

Theorem 2.7. (See [5]) if $n \geq 4$, then for each $2 \leq m \leq n - 2$, $\kappa(Q_n; C_{2^m}) \leq n - m$.

Lemma 2.8. (See [1]) For an integer $n \geq 4$, $\kappa(Q_n; C_6) \geq \lceil \frac{n}{3} \rceil$.

Theorem 2.9. (See [6]) Q_n is Hamiltonian.

3. $\kappa(Q_n; P_k)$ and $\kappa^s(Q_n; P_k)$ for $n \geq 3$ and $3 \leq k \leq 2^{n-1}$

In this section we discuss H -structure connectivity and H -substructure connectivity of Q_n with H the path of length $k - 1$.

Lemma 3.1. If $n \geq 3$ and $3 \leq k \leq 2^{n-1}$, then

$$\kappa^s(Q_n; P_k) \leq \kappa(Q_n; P_k) \leq \begin{cases} \lceil \frac{2n}{k+1} \rceil & \text{if } k \text{ is odd,} \\ \lceil \frac{2n}{k} \rceil & \text{if } k \text{ is even.} \end{cases} \quad (3.1)$$

Proof. We take the vertex $v = 00 \dots 0$.

Case 1. k is odd.

Subcase 1.1. $k \geq 2n - 1$. We notice that there is a hamiltonian cycle in Q_n^1 with $\phi(((v)^{n-2})^{n-1}, (v)^{n-1})$ as one of its edges by Theorem 2.9 and the symmetry of Q_n^1 . Denote $u_i, (i = 1, 2, \dots, 2^{n-1} - 2)$ the i^{th} vertex after $((v)^{n-2})^{n-1}$ and $(v)^{n-1}$ along the hamiltonian

cycle. Then $F = \{((v)^0, ((v)^0)^1, (v)^1, \dots, (v)^{n-2}, ((v)^{n-2})^{n-1}, (v)^{n-1}, u_1, \dots, u_{k-(2n-1)})\}$ is a P_k -structure cut of Q_n leaves at least two connected components in $Q_n - V(F)$ and $\{v\}$ is one of them. So $\kappa(Q_n; P_k) \leq 1 = \lceil \frac{2n}{k+1} \rceil$.

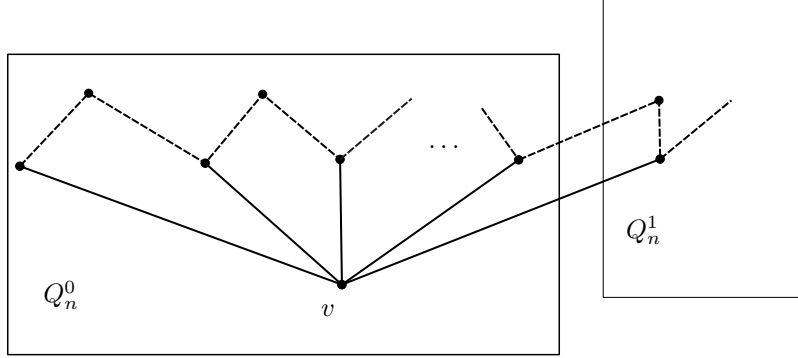

Fig 3. $k \geq 2n - 1$

Subcase 1.2. $1 \leq k \leq 2n - 1$.

Subcase 1.2.1. $\frac{k+1}{2}$ divides n . Let $F = \{P_k^i | i = 0, 1, \dots, \frac{2n}{k+1} - 1\}$ in which $P_k^i = ((v)^{i \frac{k+1}{2}}, ((v)^{i \frac{k+1}{2}})^{i \frac{k+1}{2} + 1}, (v)^{i \frac{k+1}{2} + 1}, \dots, (v)^{(i+1) \frac{k+1}{2} - 1})$. Then F is obviously a P_k -structure cut of Q_n , implies $\kappa(Q_n; P_k) \leq \frac{2n}{k+1} = \lceil \frac{2n}{k+1} \rceil$.

Subcase 1.2.2. $\frac{k+1}{2}$ does not divide n . Let $F = \{P_k^i | i = 0, 1, \dots, \lceil \frac{2n}{k+1} \rceil - 1\}$ in which $P_k^i = ((v)^{i \frac{k+1}{2}}, ((v)^{i \frac{k+1}{2}})^{i \frac{k+1}{2} + 1}, (v)^{i \frac{k+1}{2} + 1}, \dots, (v)^{(i+1) \frac{k+1}{2} - 1})$ for $i = 0, \dots, \lceil \frac{2n}{k+1} \rceil - 2$ and $P_k^{\lceil \frac{2n}{k+1} \rceil - 1} = ((v)^{n - \frac{k+1}{2}}, ((v)^{n - \frac{k+1}{2}})^{n - \frac{k+1}{2} + 1}, (v)^{n - \frac{k+1}{2} + 1}, \dots, (v)^{n-1})$. Then F is obviously a P_k -structure cut of Q_n , implies $\kappa(Q_n; P_k) \leq \lceil \frac{2n}{k+1} \rceil$.

Let's have $n = 5$ and $k = 3$ as an example:

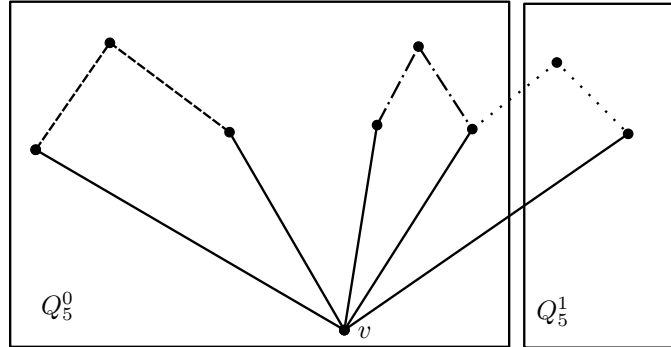

Fig 4. $n = 5$ and $k = 3$

Case 2. k is even.

Subcase 2.1. $k \geq 2n$. The proof is as same as **Subcase 1.1.**

Subcase 2.2. $2 \leq k \leq 2n - 2$.

Subcase 2.2.1. $\frac{k}{2}$ divides n . Let $F = \{P_k^i | i = 0, 1, \dots, \frac{2n}{k} - 1\}$ in which $P_k^i = ((v)^{i\frac{k}{2}}, ((v)^{i\frac{k}{2}})^{i\frac{k}{2}+1}, (v)^{i\frac{k}{2}+1}, \dots, (v)^{(i+1)\frac{k}{2}-1}, ((v)^{(i+1)\frac{k}{2}-1})^{(i+1)\frac{k}{2}})$ for $i = 0, \dots, \frac{2n}{k} - 1$. Then F is obviously a P_k -structure cut of Q_n , implies $\kappa(Q_n; P_k) \leq \frac{2n}{k} = \lceil \frac{2n}{k} \rceil$.

Subcase 2.2.2. $\frac{k}{2}$ does not divide n . Let $F = \{P_k^i | i = 0, 1, \dots, \lceil \frac{2n}{k} \rceil - 1\}$ in which $P_k^i = ((v)^{i\frac{k}{2}}, ((v)^{i\frac{k}{2}})^{i\frac{k}{2}+1}, (v)^{i\frac{k}{2}+1}, \dots, (v)^{(i+1)\frac{k}{2}-1}, ((v)^{(i+1)\frac{k}{2}-1})^{(i+1)\frac{k}{2}})$ for $i = 0, \dots, \lceil \frac{2n}{k} \rceil - 2$ and $P_k^{\lceil \frac{2n}{k} \rceil - 1} = ((v)^{n-\frac{k}{2}}, ((v)^{n-\frac{k}{2}})^{n-\frac{k}{2}+1}, (v)^{n-\frac{k}{2}+1}, \dots, (v)^{n-1}, ((v)^{n-1})^0)$. Then F is obviously a P_k -structure cut of Q_n , implies $\kappa(Q_n; P_k) \leq \lceil \frac{2n}{k} \rceil$. \square

Lemma 3.2. For $n \geq 3$ and $3 \leq k \leq 2^{n-1}$, let $k = 3q_k + r_k$ with non-negative integers q_k and r_k and $0 \leq r_k \leq 2$. If u and v are adjacent in $Q_n - V(P_k)$, then $|N_{Q_n}(\{u, v\}) \cap V(P_k)| \leq 2q_k + r_k$. In particular, $|N_{Q_n}(\{u, v\}) \cap V(P_k)| \leq k - 1$.

Proof. Denote the vertices in $V(P_k)$ in turn as $v_i (i = 1, 2, \dots, k)$. First of all, we prove $|N_{Q_n}(\{u, v\}) \cap \{v_{i-1}, v_i, v_{i+1}\}| \leq 2 (i = 2, 3, \dots, k-1)$ by contradiction. Suppose $|N_{Q_n}(\{u, v\}) \cap \{v_{i'-1}, v_{i'}, v_{i'+1}\}| = 3$ for some integer $2 \leq i' \leq k-1$, without loss of generality, we assume u is adjacent to $v_{i'-1}$ and $v_{i'+1}$ and v is adjacent to $v_{i'}$. Then $d(u, v_{i'}) = 2$ but u and $v_{i'}$ have 3 common neighborhoods: $v, v_{i'-1}, v_{i'+1}$, leads a contradiction by Lemma 2.4.

Then we prove the lemma by induction on k . For $k = 3$, $|N_{Q_n}(\{u, v\}) \cap \{v_1, v_2, v_3\}| \leq 2$ by the statement above. Assume that $|N_{Q_n}(\{u, v\}) \cap V(P_k)| \leq 2q_k + r_k$ is true for $3 \leq k \leq l$ with integer $3 \leq l \leq 2^{n-1} - 1$. For $k = l+1$, $|N_{Q_n}(\{u, v\}) \cap V(P_{l+1})| \leq |N_{Q_n}(\{u, v\}) \cap V(P_l)| + 1 \leq 2q_l + r_l + 1$ by inductive hypothesis.

Case 1. $r_{l+1} = 1$ and 2 . Notice that in this case $r_{l+1} = r_l + 1$ and $q_{l+1} = q_l$, so we have $|N_{Q_n}(\{u, v\}) \cap V(P_{l+1})| \leq 2q_l + r_l + 1 = 2q_{l+1} + r_{l+1}$.

Case 2. $r_{l+1} = 0$ and $l \geq 5$. Since $|N_{Q_n}(\{u, v\}) \cap \{v_{i-1}, v_i, v_{i+1}\}| \leq 2 (i = 2, 3, \dots, k-1)$ we have $|N_{Q_n}(\{u, v\}) \cap V(P_{l+1})| \leq |N_{Q_n}(\{u, v\}) \cap V(P_{l-2})| + 2 \leq 2q_{l-2} + 2 \leq 2q_{l+1}$.

In particular, $|N_{Q_n}(\{u, v\}) \cap V(P_k)| \leq 2q_k + r_k = k - q_k \leq k - 1$. \square

Lemma 3.3. For $n \geq 3$ and $3 \leq k \leq 2^{n-1}$,

$$\kappa^s(Q_n; P_k) \geq \begin{cases} \lceil \frac{2n}{k+1} \rceil & \text{if } k \text{ is odd,} \\ \lceil \frac{2n}{k} \rceil & \text{if } k \text{ is even.} \end{cases} \quad (3.2)$$

Proof. Let $F = \{P_1^1, P_1^2, \dots, P_1^{a_1}, P_2^1, \dots, P_2^{a_2}, \dots, P_k^1, \dots, P_k^{a_k}\}$ a set of paths of length less than $k - 1$.

For $n = 3$, k must be 3 or 4, $|F| \leq \lceil \frac{6}{k} \rceil - 1 = 1 (k = 3, 4)$. If $k = 3$, then $Q_3 - V(F)$ is connected by Theorem 2.6, a contradiction. If $k = 4$ and $a_4 = 0$, then $Q_3 - V(F)$ is connected by Theorem 2.6, a contradiction. If $a_4 = 1$, let $F = \{P_4\}$ and all possible cases of P_4 are showed in the following figures by the symmetry of Q_3 , and we can see $Q_3 - V(F)$ is connected, a contradiction.

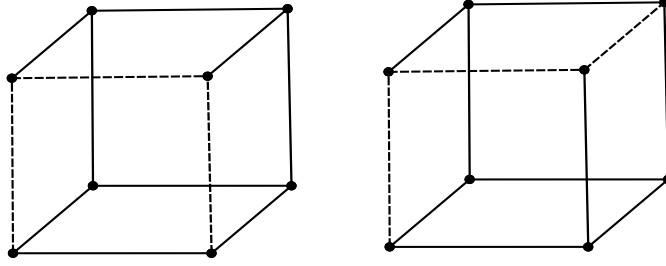

Fig 5.

For $n \geq 4$,

Case 1. k is odd. We prove that for $|F| \leq \lceil \frac{2n}{k+1} \rceil - 1$, $Q_n - V(F)$ is connected by contradiction. Suppose $Q_n - V(F)$ is disconnected, we denote C one of the smallest components of it, that means the components who have the smallest number of vertices.

Subcase 1.1. $|V(C)| = 1$. Let $V(C) = \{u\}$, u is adjacent to at most $\frac{k+1}{2}$ vertices on each path in F since there is no 3-cycle in Q_n . Therefore $\frac{k+1}{2}|F| \geq n$ i.e. $\frac{k+1}{2}(\lceil \frac{2n}{k+1} \rceil - 1) \geq n$, a contradiction.

Subcase 1.2. $|V(C)| \geq 2$. For $n = 4$, $\kappa_1(Q_4) = \frac{4(4-1)}{2} = 6$ by Theorem 2.5, but $|V(F)| \leq k(\lceil \frac{8}{k+1} \rceil - 1) < 6$, a contradiction. For $n \geq 5$, $\kappa_1(Q_n) = 2n - 2$ by Theorem 2.5, the number of deleted vertices should be at least $2n - 2$ i.e. $|V(F)| \geq 2n - 2$. But $|V(F)| \leq k(\lceil \frac{2n}{k+1} \rceil - 1) \leq k(\frac{2n+k-1}{k+1} - 1) = \frac{k}{k+1}(2n - 2) < 2n - 2$, a contradiction.

Case 2. k is even. We prove that for $|F| \leq \lceil \frac{2n}{k} \rceil - 1$, $Q_n - V(F)$ is connected by contradiction. Suppose $Q_n - V(F)$ is disconnected, we denote C one of the smallest components of it.

Subcase 2.1. $|V(C)| = 1$. Let $V(C) = \{u\}$, u is adjacent to at most $\frac{k}{2}$ vertices on each path in F . Therefore $\frac{k}{2}|F| \geq n$ i.e. $\frac{k}{2}(\lceil \frac{2n}{k} \rceil - 1) \geq n$, a contradiction.

Subcase 2.2. $|V(C)| = 2$. Let $V(C) = \{u, v\}$, it is obvious that $|N_{Q_n}(\{u, v\})| = 2n - 2$. For each path $P \in F$, $|N_{Q_n}(\{u, v\}) \cap V(P)| \leq k - 1$ by Lemma 3.2. Therefore F must has at least $\lceil \frac{2n-2}{k-1} \rceil$ elements, but $|F| \leq \lceil \frac{2n}{k} \rceil - 1 \leq \frac{2n+k-2}{k} - 1 = \frac{2n-2}{k} < \lceil \frac{2n-2}{k-1} \rceil$, a contradiction.

Subcase 2.3. $|V(C)| \geq 3$.

Subcase 2.3.1. For $n \geq 6$, we have $|V(F)| \leq k(\lceil \frac{2n}{k} \rceil - 1) < 3n - 5 = \kappa_2(Q_n)$, a contradiction.

Subcase 2.3.2. For $n = 5$, we have $|V(F)| \leq k(\lceil 10/k \rceil - 1) < \frac{5(5-1)}{2} = 10 = \kappa_2(Q_5)$, a contradiction.

Subcase 2.3.3. For $n = 4$, if $k = 4, 8$, we have $|V(F)| \leq k(\lceil 8/k \rceil - 1) < \frac{4(4-1)}{2} = 6 = \kappa_2(Q_4)$, a contradiction.

k	$k(\lceil 10/k \rceil - 1)$	$\kappa_2(Q_5)$	k	$k(\lceil 8/k \rceil - 1)$	$\kappa_2(Q_4)$
4	8	10	4	4	6
6	6		8	0	6
8	8				
≥ 10	0				

If $k = 6$, we have $\lceil 8/6 \rceil - 1 = 1$. If $a_6 = 0$, We can think of F as a P_5 -substructure cut and $Q_4 - V(F)$ is connected by Case 1., a contradiction.

If $a_6 = 1$, let $F = \{P_6\}$, without loss of generality, we assume the first 3 vertices of P_6 are $u = 0000$, $v = 1000$ and $w = 1100$ by the symmetry of Q_4 . If $|V(P_6) \cap V(Q_4^1)| = 0$, then $Q_4^1 - V(F)$ is connected, therefore $Q_4 - V(F)$ is connected since there is a perfect matching between Q_4^0 and Q_4^1 , a contradiction. If $|V(P_6) \cap V(Q_4^1)| = 1$, let $V(P_6) \cap V(Q_4^1) = \{x\}$, then $(x)^3 \in V(P_6)$ and obviously $Q_4^1 - \{x\}$ is connected, therefore $Q_4 - V(F)$ is connected by the perfect matching, a contradiction. If $|V(P_6) \cap V(Q_4^1)| = 2$, all possible cases of P_6 are showed in following figures, and we can see $Q_4 - V(F)$ is connected, a contradiction.

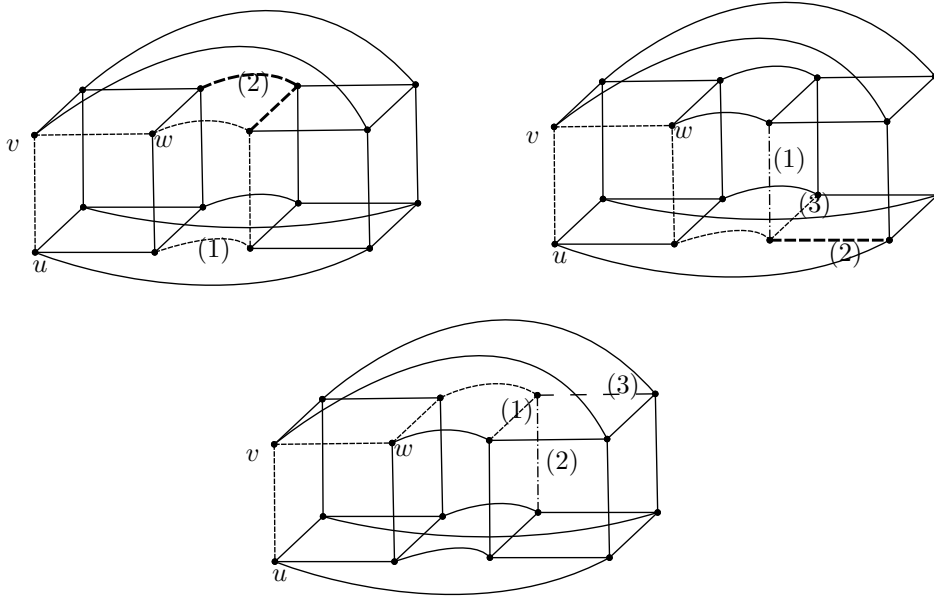

Fig 6. Different types of lines represent different ways to construct P_6 with startpoint u .

If $|V(P_6) \cap V(Q_4^1)| = 3$, by Theorem 2.6, $Q_4^i - V(F)$ ($i = 0, 1$) is connected. Suppose $Q_4 - V(F)$ is disconnected, then $(y)^3 \in V(F)$ for each $y \in Q_4^0 - V(F)$ and this leads $2^3 - 3 \leq 3$, a contradiction, so $Q_4 - V(F)$ is connected, a contradiction.

□

By Lemma 3.1 and Lemma 3.3, we have the following Theorem.

Theorem 3.4. For $n \geq 3$ and $3 \leq k \leq 2^{n-1}$

$$\kappa^s(Q_n; P_k) = \kappa(Q_n; P_k) = \begin{cases} \lceil \frac{2n}{k+1} \rceil & \text{if } k \text{ is odd,} \\ \lceil \frac{2n}{k} \rceil & \text{if } k \text{ is even.} \end{cases} \quad (3.3)$$

4. $\kappa(Q_n; C_k)$ and $\kappa^s(Q_n; C_k)$ for $n \geq 3$ and $4 \leq k \leq 2^{n-1}$ and k is even

In this section we discuss H -structure connectivity and H -substructure connectivity of Q_n with H the cycle of length k .

Lemma 4.1. For $n \geq 3$ and odd integer $3 \leq k \leq 2^{n-1}$, $\kappa^s(Q_n; C_k) = \lceil \frac{2n}{k+1} \rceil$.

Proof. $\kappa^s(Q_n; C_k) = \kappa^s(Q_n; P_k) = \lceil \frac{2n}{k+1} \rceil$ because there is no odd cycle in Q_n . □

Lemma 4.2. For $n \geq 3$ and even integer $3 \leq k \leq 2^{n-1}$, $\kappa^s(Q_n; C_k) \leq \lceil \frac{2n}{k} \rceil$.

Proof. $\kappa^s(Q_n; C_k) \leq \kappa^s(Q_n; P_k) = \lceil \frac{2n}{k} \rceil$. □

Lemma 4.3. For $n \geq 3$ and $3 \leq k \leq 2^{n-1}$, if vertices u and v are adjacent in $Q_n - C_k$, then $|N_{Q_n}(\{u, v\}) \cap V(C_k)| \leq k - 1$.

Proof. We proof the lemma by contradiction. Suppose $|N_{Q_n}(\{u, v\}) \cap V(C_k)| = k$ i.e. each vertex in $V(C_k)$ is adjacent to either u or v . Take vertices $v_i \in V(C_k) (i = 1, 2, 3)$ such that $\phi(v_1, v_2) \in E(Q_n)$ and $\phi(v_2, v_3) \in E(Q_n)$. Without loss of generality, we assume that $v_1, v_3 \in N_{Q_n}(u)$ and $v_2 \in N_{Q_n}(v)$, then $d(u, v_2) = 2$ but $N_{Q_n}(u) \cap N_{Q_n}(v_2) = \{v, v_1, v_3\}$, a contradiction. \square

Lemma 4.4. For $n \geq 3$ and even integer $4 \leq k \leq 2^{n-1}$, $\kappa^s(Q_n; C_k) \geq \lceil \frac{2n}{k} \rceil$.

Proof. Let $F = \{P_1^1, P_1^2, \dots, P_1^{a_1}, P_2^1, \dots, P_2^{a_2}, \dots, P_k^1, \dots, P_k^{a_k}, C_k^1, \dots, C_k^b\}$ a set of paths of length less than $k - 1$ and cycles of length k . We prove that if $|F| \leq \lceil \frac{2n}{k} \rceil - 1$ then $Q_n - V(F)$ is connected.

Case 1. $b = 0$. In this case we can think of F a P_k -substructure cut, $Q_n - V(F)$ is connected by Theorem 3.4.

Case 2. $b > 0$.

Subcase 2.1. $n = 3$. k must be 4 and $|F| \leq \lceil \frac{6}{4} \rceil - 1 = 1$. Let $F = \{C_4\}$ and let $V(C_4) = \{v_0 = 000, v_1 = 100, v_2 = 110, v_3 = 010\}$ by the symmetry of Q_3 . Obviously $Q_3 - V(F)$ is connected.

Subcase 2.2. $n \geq 4$. We prove $Q_n - V(F)$ is connected by contradiction. Suppose $Q_n - V(F)$ is disconnected, we denote C one of the smallest components of it.

Subcase 2.2.1. $|V(C)| = 1$. Let $V(C) = \{u\}$, u is adjacent to at most $\frac{k}{2}$ vertices on each cycle in F . Therefore $\frac{k}{2}|F| \geq n$ i.e. $\frac{k}{2}(\lceil \frac{2n}{k} \rceil - 1) \geq n$, a contradiction.

Subcase 2.2.2. $|V(C)| = 2$. Let $V(C) = \{u, v\}$, it is obvious that $|N_{Q_n}(\{u, v\})| = 2n - 2$. For each cycle $C \in F$, $|N_{Q_n}(\{u, v\}) \cap V(C)| \leq k - 1$ by Lemma 4.3. Therefore F must has at least $\lceil \frac{2n-2}{k-1} \rceil$ elements, but $|F| \leq \lceil \frac{2n}{k} \rceil - 1 \leq \frac{2n+k-2}{k} - 1 = \frac{2n-2}{k} < \lceil \frac{2n-2}{k-1} \rceil$, a contradiction.

Subcase 2.2.3. $|V(C)| \geq 3$.

Subcase 2.2.3.1. For $n \geq 5$ and $n = 4, k = 4, 8$ the discussion is the same as Lemma 3.3.

Subcase 2.2.3.2. For $n = 4, k = 6$, $|F| \leq \lceil \frac{8}{6} \rceil - 1 = 1$. Let $F = \{C_6\}$, F is a C_6 -structure cut and $2 = \lceil \frac{4}{3} \rceil \leq \kappa(Q_4, C_6) \leq 1$ by Lemma 2.8, a contradiction. \square

By Lemma 4.2 and Lemma 4.4, we have the following theorem.

Theorem 4.5. For $n \geq 3$ and even integer $3 \leq k \leq 2^{n-1}$, $\kappa(Q_n; C_k) \geq \kappa^s(Q_n; C_k) = \lceil \frac{2n}{k} \rceil$.

Lemma 4.6. For $n = 3$, it is obvious that $\kappa(Q_3; C_4) = 2$.

Lemma 4.7. (See. [6]) A cycle of length l can be mapped into Q_n when l is even and $4 \leq l \leq 2^n$.

Lemma 4.8. For $n \geq 2$ and odd integer $1 \leq q \leq 2^n - 1$, each pair of adjacent vertices u and v in Q_n have a path of length q between them.

Proof. The lemma is true when $q = 1$ because u, v are adjacent. When $q \geq 3$, there is a cycle C_{q+1} of length $q + 1$ with $\phi(u, v) \in E(C_{q+1})$, $C_{q+1} - \{\phi(u, v)\}$ is the path required. \square

Lemma 4.9. For $n \geq 4$ and l even,

$$\kappa(Q_n; C_l) \begin{cases} = n - 2 & l=4, \\ \leq \lceil \frac{2n}{l} \rceil & n \geq 5 \text{ and } 6 \leq l \leq 2^{n-2}. \end{cases} \quad (4.1)$$

Proof. For $l = 4$, $\kappa(Q_n; C_4) = n - 2$ by Theorem 2.6.

For $n \geq 5$ and $6 \leq l \leq 2^{n-2}$, Let $u = 00 \dots 0$.

Case 1. $\frac{l}{2} \leq n$.

Subcase 1.1. n is divided by $\frac{l}{2}$. Let $F = \{C_l^i | i = 0, 2, \dots, \lceil \frac{2n}{l} \rceil - 1 = 2n/l - 1\}$ with $C_l^i = \left((u)^{i\frac{l}{2}}, \left((u)^{i\frac{l}{2}} \right)^{i\frac{l}{2}+1}, (u)^{i\frac{l}{2}+1}, \dots, (u)^{(i+1)\frac{l}{2}-1}, \left((u)^{(i+1)\frac{l}{2}-1} \right)^{i\frac{l}{2}}, (u)^{i\frac{l}{2}} \right)$. Then F is a C_l -structure cut of Q_n .

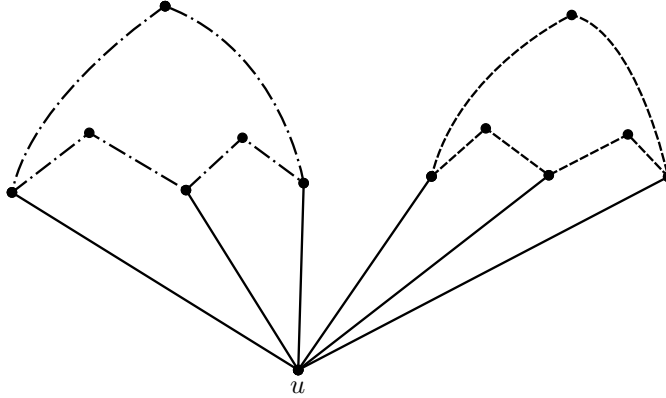

Fig 7. Let's have $n = 6$ and $l = 6$ as an example.

Subcase 1.2. n is not divided by $\frac{l}{2}$. Let $F = \{C_l^i | i = 0, 2, \dots, \lceil \frac{2n}{l} \rceil - 1\}$ with $C_l^i = \left((u)^{i\frac{l}{2}}, \left((u)^{i\frac{l}{2}} \right)^{i\frac{l}{2}+1}, (u)^{i\frac{l}{2}+1}, \dots, (u)^{(i+1)\frac{l}{2}-1}, \left((u)^{(i+1)\frac{l}{2}-1} \right)^{i\frac{l}{2}}, (u)^{i\frac{l}{2}} \right)$ ($i = 0, \dots, \lceil \frac{2n}{l} \rceil - 2$). $C_l^{\lceil \frac{2n}{l} \rceil - 1} = \left\{ (u)^{n-\frac{l}{2}}, \left((u)^{n-\frac{l}{2}} \right)^{n-\frac{l}{2}+1}, (u)^{n-\frac{l}{2}+1}, \dots, (u)^{n-1}, \left((u)^{n-1} \right)^{n-\frac{l}{2}}, (u)^{n-\frac{l}{2}} \right\}$. Then F is a C_l -structure cut of Q_n .

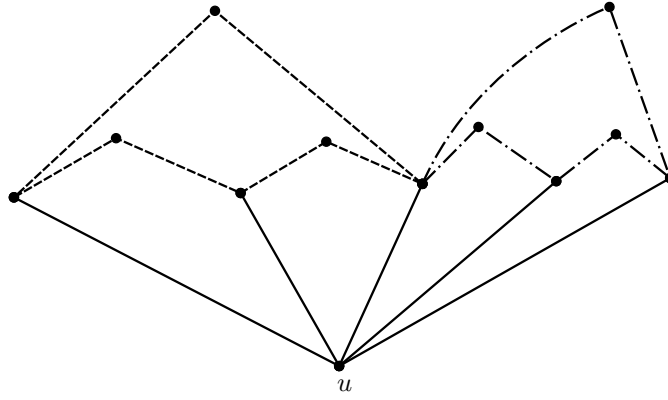

Fig 8. Let's have $n = 5$ and $l = 6$ as an example.

Case 2. $\frac{l}{2} \geq n + 1$. In this case $\lceil \frac{2n}{l} \rceil = 1$ and $l \geq 2n + 2$. Let Q the subgraph of Q_n with $V(Q) = \{v = x_0x_1 \dots x_{n-3}01 \mid x_i = 0 \text{ or } 1, i = 0, 1, \dots, n - 3\}$, obviously $((u^0)^{n-1})$ and $(u)^{n-1}$ are belong to $V(Q)$, there is a path P of length $l - (2n - 1)$ between $((u^0)^{n-1})$ and $(u)^{n-1}$ in Q by Lemma 4.8. Let $F = \{C_l\}$ with $C_l = ((u^0)^0, ((u^0)^0)^1, \dots, ((u^{n-2})^{n-1}, (u)^{n-1}, P, ((u^0)^{n-1}, (u^0)^0)$, Then F is a C_l -structure cut of Q_n .

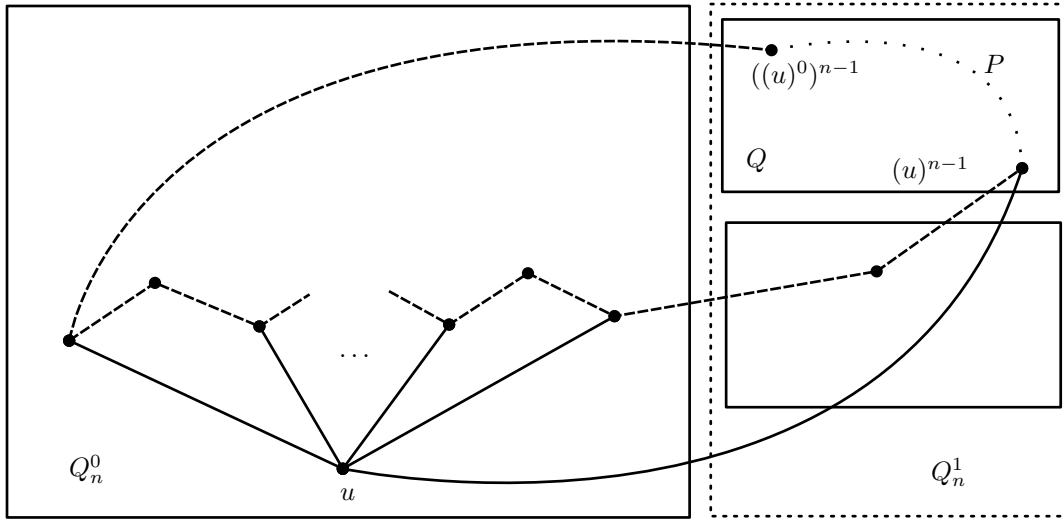

Fig 9.

□

From Lemma 4.1, Lemma 4.5, Lemma 4.6 and Lemma 4.9 we can obtain the following theorem.

Theorem 4.10. For $n \geq 3$

$$\kappa^s(Q_n; C_l) = \begin{cases} \lceil \frac{2n}{l+1} \rceil & l \text{ is odd and } 3 \leq l \leq 2^{n-1}, \\ \lceil \frac{2n}{l} \rceil & l \text{ is even and } 4 \leq l \leq 2^{n-1}. \end{cases} \quad (4.2)$$

$$\kappa(Q_n; C_l) \begin{cases} = 2 & n = 3, l = 4, \\ = n - 2 & n \geq 4 \text{ and } l = 4, \\ = \lceil \frac{2n}{l} \rceil & n \geq 5, l \text{ is even and } 6 \leq l \leq 2^{n-2}, \\ \geq \lceil \frac{2n}{l} \rceil & n \geq 4, l \text{ is even and } 2^{n-2} + 2 \leq l \leq 2^{n-1}. \end{cases} \quad (4.3)$$

Lemma 4.11. For $n = 4, 5$ and $2 \leq m \leq n - 2$, $\kappa(Q_n; C_{2^m}) = n - m$.

Proof. We have $\kappa(Q_n; C_{2^m}) \geq \lceil \frac{n}{2^{m-1}} \rceil$ by Lemma 4.5. We also have $\kappa(Q_n; C_{2^m}) \leq n - m$ by Lemma 2.7.

	$\lceil \frac{n}{2^{m-1}} \rceil$	$n - m$
$n = 4, m = 2$	2	2
$n = 5, m = 2$	3	3
$n = 5, m = 3$	2	2

So the lemma is proved. □

Lemma 4.12. For $n \geq 6$ and $3 \leq m \leq n - 2$, $\kappa(Q_n; C_{2^m}) = \kappa^s(Q_n; C_{2^m}) = \lceil \frac{n}{2^{m-1}} \rceil$

Proof. By Theorem 4.10. □

Lemma 4.13. For $n \geq 6$ and $3 \leq m \leq n - 2$, $\lceil \frac{n}{2^{m-1}} \rceil < n - m$.

Proof. For a given integer $n \geq 6$, let $f(m) = \frac{n}{2^{m-1}} + 1 - (n - m)$. Derivate $f(m)$ with respect to m , $f'(m) = 1 - 2^{1-m}n \ln 2$, again derivate $f'(m)$, we have $f''(m) = 2^{1-m}n(\ln 2)^2$. Obviously, $f''(m) \geq 0$ which implies $f(m)$ monotonically increasing respect to m .

After simple calculations we obtain

$$\begin{cases} f'(3) = 1 - \frac{n \ln 2}{4} \\ f'(n-2) = 1 - \frac{n \ln 2}{2^{n-3}} \end{cases} \quad (4.4)$$

$f'(3) < 0$ when $n \geq 6$. Let $g(n) = f'(n-2) = 1 - \frac{n \ln 2}{2^{n-3}}$, derivate $g(n)$ with respect to n , $g'(n) = -2^{3-n} \ln 2(1 - n \ln 2) > 0$ when $n \geq 6$, therefore $g(n)$ monotonically increasing respect

to n and $\min_{n \geq 6} g(n) = g(6) = 1 - \frac{6 \ln 2}{8} > 0$, this implies $f'(n-2) = g(n) > 0$ and $f(m)$ firstly monotonically decreasing and then monotonically increasing respect to m . Therefore $\max_m f(m) = \max_m \{f(3), f(n-2)\}$.

By simple calculations we obtain

$$\begin{cases} f(3) = 4 - \frac{3n}{4} < 0 \\ f(n-2) = \frac{n}{2^{n-3}} - 1 \end{cases} \quad (4.5)$$

Let $h(n) = \frac{n}{2^{n-3}} - 1$, derivate $h(n)$ with respect to n , $h'(n) = 2^{3-n}(1 - n \ln 2) < 0$ when $n \geq 6$. Therefore $h(n)$ monotonically decreasing respect to n and $\max_{n \geq 6} h(n) = h(6) = \frac{6}{8} - 1 < 0$, therefore $f(n-2) < 0$ implies $f(m) = \frac{n}{2^{m-1}} + 1 - (n-m) < 0$ i.e. $\lceil \frac{n}{2^{m-1}} \rceil \leq \frac{n}{2^{m-1}} + 1 < n-m$. \square

Now we can answer the question in [5]: For $n \geq 4$ and for each $2 \leq m \leq n-2$

$$\kappa(Q_n; C_{2^m}) = \begin{cases} = n-m & n = 4, 5 \text{ or } n \geq 4, m = 2, \\ = \lceil \frac{n}{2^{m-1}} \rceil < n-m & n \geq 6 \text{ and } 3 \leq m \leq n-2. \end{cases} \quad (4.6)$$

Acknowledgements

The authors are grateful to those of you who support to us.

References

References

- [1] T. Tamizh Chelvam and M. Sivagami. Structure and substructure connectivity of circulant graphs and hypercubes. *Arab Journal of Mathematical Sciences*, 2019.
- [2] Reinhard Diestel. Graph-theory. 173(502):67–128, 2000.
- [3] Dong Li, Xiaolan Hu, and Huiqing Liu. Structure connectivity and substructure connectivity of twisted hypercubes. *Theoretical Computer Science*, 796:169 – 179, 2019.
- [4] Cheng Kuan Lin, Lili Zhang, Jianxi Fan, and Dajin Wang. Structure connectivity and substructure connectivity of hypercubes. *Theoretical Computer Science*, 634:97–107.
- [5] S. A. Mane. Structure connectivity of hypercubes. *Akce International Journal of Graphs & Combinatorics*, 15(1):49–52.
- [6] Y. Saad and M.H. Schultz. Topological properties of hypercubes. *Computers IEEE Transactions on*, 37(7):867–872.

- [7] Weihua Yang and Jixiang Meng. Extraconnectivity of hypercubes. *Applied Mathematics Letters*, 22(6):887–891.
- [8] Jin-Xin Zhou. On g-extra connectivity of hypercube-like networks. *Journal of Computer and System Sciences*, 88:208 – 219, 2017.