

THE POSITIVE TROPICAL GRASSMANNIAN, THE HYPERSIMPLEX, AND THE $m = 2$ AMPLITUHEDRON

TOMASZ LUKOWSKI, MATTEO PARISI, AND LAUREN K. WILLIAMS

ABSTRACT. The well-known moment map maps the Grassmannian $Gr_{k+1,n}$ and the positive Grassmannian $Gr_{k+1,n}^+$ onto the hypersimplex $\Delta_{k+1,n}$, which is a polytope of codimension 1 inside \mathbb{R}^n . Over the last decades there has been a great deal of work on matroid subdivisions (and positroid subdivisions) of the hypersimplex [Kap93, Laf03, Spe08, AFR10, ARW16, RVY19, Ear19]; these are closely connected to the *tropical Grassmannian* [SS04, Spe08, HJS14] and *positive tropical Grassmannian* [SW05]. Meanwhile any $n \times (k+2)$ matrix Z with maximal minors positive induces a map \tilde{Z} from $Gr_{k,n}^+$ to the Grassmannian $Gr_{k,k+2}$, whose image has full dimension $2k$ and is called the $m = 2$ *amplihedron* $\mathcal{A}_{n,k,2}$ [AHT14]. As the positive Grassmannian has a decomposition into *positroid cells* [Pos], one may ask when the images of a collection of cells of $Gr_{k+1,n}^+$ give a *dissection* of the hypersimplex $\Delta_{k+1,n}$. By *dissection*, we mean that the images of these cells are disjoint and cover a dense subset of the hypersimplex, but we do not put any constraints on how their boundaries match up. Similarly, one may ask when the images of a collection of positroid cells of $Gr_{k,n}^+$ give a dissection of the amplihedron $\mathcal{A}_{n,k,2}$. In this paper we observe a remarkable connection between these two questions: in particular, one may obtain a dissection of the amplihedron from a dissection of the hypersimplex (and vice-versa) by applying a simple operation to cells that we call the *T-duality map*. Moreover, if we think of points of the positive tropical Grassmannian $\text{Trop}^+ Gr_{k+1,n}$ as height functions on the hypersimplex, the corresponding *positroidal subdivisions* of the hypersimplex induce particularly nice dissections of the $m = 2$ amplihedron $\mathcal{A}_{n,k,2}$. Along the way, we provide a new characterization of positroid polytopes and prove new results about positroidal subdivisions of the hypersimplex.

CONTENTS

1. Introduction	2
2. The positive Grassmannian, the hypersimplex, and the amplihedron	5
3. Positroid polytopes and the moment map	8
4. Dissecting the hypersimplex and the amplihedron	11
5. The T-duality map	16
6. T-duality relates triangles, triangulations, and dissections	19
7. T-duality, cyclic symmetry and parity duality	22
8. Good and bad dissections of the hypersimplex and the amplihedron	25
9. The positive tropical Grassmannian and positroidal subdivisions	27
10. Regular positroidal subdivisions of $\Delta_{k+1,n}$ and $\mathcal{A}_{n,k,2}$ from $\text{Trop}^+ Gr_{k+1,n}$	32
11. Mathematica experiments	35

LW was partially supported by NSF grants DMS-1854316 and DMS-1854512.

12.	T-duality and the momentum amplituhedron for general (even) m	37
13.	Summary and outlook	41
14.	Appendix. Combinatorics of cells of the positive Grassmannian.	42
	References	47

1. INTRODUCTION

In 1987, the foundational work of Gelfand-Goresky-MacPherson-Serganova [GGMS87] initiated the study of the Grassmannian and torus orbits in the Grassmannian via the *moment map* and *matroid polytopes*, which arise as moment map images of (closures of) torus orbits. Classifying points of the Grassmannian based on the moment map images of the corresponding torus orbits leads naturally to the *matroid stratification* of the Grassmannian. The moment map image of the entire Grassmannian $Gr_{k+1,n}$ is the $(n-1)$ -dimensional hypersimplex $\Delta_{k+1,n} \subseteq \mathbb{R}^n$, the convex hull of the indicator vectors $e_I \in \mathbb{R}^n$ where $I \in \binom{[n]}{k+1}$. Over the last decades there has been a great deal of work on matroid subdivisions of the hypersimplex [Kap93, Laf03, Spe08]; these are closely connected to the *tropical Grassmannian* [SS04, Spe08, HJS14] and the *Dressian* [HJS14], which parametrizes regular matroidal subdivisions of the hypersimplex.

The matroid stratification of the real Grassmannian is notoriously complicated: Mnev’s universality theorem says that the topology of the matroid strata can be as bad as that of any algebraic variety. However, there is a subset of the Grassmannian called the *totally non-negative Grassmannian* or (informally) the *positive Grassmannian* [Lus94, Pos], where these difficulties disappear: the restriction of the matroid stratification to the positive Grassmannian gives a cell complex [Pos, Rie98, PSW09], whose cells S_π are called *positroid cells* and labelled by (among other things) *decorated permutations*. Since the work of Postnikov [Pos], there has been an extensive study of *positroids* [Oh11, ARW16, ARW17] – the matroids associated to the positroid cells. The moment map images of positroid cells are precisely the positroid polytopes [TW15], and as we will discuss in this paper, the *positive tropical Grassmannian* [SW05] (which equals the *positive Dressian* [SW]) parametrizes the regular positroidal subdivisions of the hypersimplex.

Besides the moment map, there is another interesting map on the positive Grassmannian, which was recently introduced by Arkani-Hamed and Trnka [AHT14] in the context of *scattering amplitudes* in $\mathcal{N} = 4$ SYM. In particular, any $n \times (k+m)$ matrix Z with maximal minors positive induces a map \tilde{Z} from $Gr_{k,n}^+$ to the Grassmannian $Gr_{k,k+m}$, whose image has full dimension mk and is called the *amplituhedron* $A_{n,k,m}$ [AHT14]. The case $m = 4$ is most relevant to physics: in this case, the *BCFW recurrence* gives rise to collections of $4k$ -dimensional cells in $Gr_{k,n}^+$, whose images conjecturally “triangulate” the amplituhedron.

Given that the hypersimplex and the amplituhedron are images of the positive Grassmannian, which has a nice decomposition into positroid cells, one can ask the following questions: When does a collection of positroid cells give – via the moment map – a *positroid dissection* of the hypersimplex? By *dissection*, we mean that the images of these cells are disjoint and cover a dense subset of the hypersimplex (but we do not put any constraints on how their

boundaries match up). And when does a collection of positroid cells give – via the \tilde{Z} -map – a dissection of the amplituhedron? We can also ask about *positroid “triangulations”*, which are dissections in which the moment map (respectively, the \tilde{Z} -map) are injections on the various cells.

The combinatorics of positroid triangulations for both the hypersimplex and the amplituhedron is very interesting: Speyer’s f -vector theorem [Spe08, Spe09] gives an upper bound on the number of matroid polytopes of each dimension in a matroidal subdivision coming from the tropical Grassmannian. In particular, it says that the number of top-dimensional matroid polytopes in such a subdivision of $\Delta_{k+1,n}$ is at most $\binom{n-2}{k}$. This number is in particular achieved by finest positroidal subdivisions [SW]. Meanwhile, it is conjectured [KWZ] that the number of cells in a triangulation of the amplituhedron $\mathcal{A}_{n,k,m}$ for even m is precisely $M(k, n - k - m, \frac{m}{2})$, where

$$M(a, b, c) := \prod_{i=1}^a \prod_{j=1}^b \prod_{k=1}^c \frac{i + j + k - 1}{i + j + k - 2}$$

is the number of plane partitions contained in an $a \times b \times c$ box. Note that when $m = 2$, this conjecture says that the number of cells in a triangulation of $\mathcal{A}_{n,k,2}$ equals $\binom{n-2}{k}$.

What we show in this paper is that the appearance of the number $\binom{n-2}{k}$ in the context of both the hypersimplex $\Delta_{k+1,n}$ and the amplituhedron $\mathcal{A}_{n,k,2}$ is not a coincidence! Indeed, we can obtain triangulations of the amplituhedron from triangulations of the hypersimplex, by applying a *T-duality map*. This T-duality map sends loopless positroid cells S_π of $Gr_{k+1,n}^+$ to coloopless positroid cells $S_{\hat{\pi}}$ of $Gr_{k,n}^+$ via a simple operation on the decorated permutations, see Section 5. T-duality sends *generalized triangles* for the hypersimplex (cells where the moment map is injective) to generalized triangles for the amplituhedron (cells where \tilde{Z} is injective), see Proposition 6.6, and moreover it sends dissections of the hypersimplex to dissections of the amplituhedron, see Theorem 6.5. This explains the two appearances of the number $\binom{n-2}{k}$ on the two sides of the story.

The fact that dissections of $\Delta_{k+1,n}$ and $\mathcal{A}_{n,k,2}$ are in bijection is a rather surprising statement. Should there be a map from $\Delta_{k+1,n}$ to $\mathcal{A}_{n,k,2}$ or vice-versa? We have $\dim \Delta_{k+1,n} = n - 1$ and $\dim \mathcal{A}_{n,k,2} = 2k$, with no relation between $n - 1$ and $2k$ (apart from $k \leq n$) so it is not obvious that a nice map between them should exist. Nevertheless we do show that T-duality descends from a certain map that can be defined directly on positroid cells of $Gr_{k+1,n}^+$.

The T-duality map provides a handy tool for studying the amplituhedron $\mathcal{A}_{n,k,2}$: we can try to understand properties of the amplituhedron (and its dissections) by studying the hypersimplex and applying T-duality. For example, we show in Section 7 that the rather mysterious *parity duality*, which relates dissections of $\mathcal{A}_{n,k,2}$ with dissections of $\mathcal{A}_{n,n-k-2,2}$, can be obtained by composing the hypersimplex duality $\Delta_{k+1,n} \simeq \Delta_{n-k-1,n}$ (which comes from the Grassmannian duality $Gr_{k+1,n} \simeq Gr_{n-k-1,n}$) with T-duality on both sides. As another example, we can try to obtain “nice” dissections of the amplituhedron from correspondingly nice dissections of the hypersimplex. In general, dissections of $\Delta_{k+1,n}$ and $\mathcal{A}_{n,k,2}$ may have unpleasant properties, with images of cells intersecting badly at their boundaries, see Section 8. However, the *regular subdivisions* of $\Delta_{k+1,n}$ are very nice polyhedral subdivisions. By Theorem 9.12, the regular positroidal dissections of $\Delta_{k+1,n}$ come precisely from the positive

Dressian $Dr_{k+1,n}^+$ (which equals the positive tropical Grassmannian $\text{Trop}^+ Gr_{k+1,n}$). And moreover the images of these subdivisions under the T-duality map are very nice subdivisions of the amplituhedron $\mathcal{A}_{n,k,2}$, see Section 10. We speculate that $\text{Trop}^+ Gr_{k+1,n}$ plays the role of secondary fan for the regular positroidal subdivisions of $\mathcal{A}_{n,k,2}$, see Conjecture 10.4.

One step in proving Theorem 9.12 is the following new characterization of positroid polytopes (see Theorem 3.8): a matroid polytope is a positroid polytope if and only if all of its two-dimensional faces are positroid polytopes.

Let us now explain how the various geometric objects in our story are related to scattering amplitudes in supersymmetric fields theories. The main emphasis so far has been on the so-called “planar limit” of $\mathcal{N} = 4$ super Yang-Mills. In 2009, the works of Arkani-Hamed–Cachazo–Cheung–Kaplan [AHCK10] and Bullimore–Mason–Skinner [BMS10] introduced beautiful Grassmannian formulations for scattering amplitudes in this theory. Remarkably, this led to the discovery that the positive Grassmannian encodes most of the physical properties of amplitudes [AHBC⁺16]. Building on these developments and on Hodges’ idea that scattering amplitudes might be ‘volumes’ of some geometric object [Hod13], Arkani-Hamed and Trnka arrived at the definition of the *amplituhedron* $\mathcal{A}_{n,k,m}$ [AHT14] in 2013.

The $m = 4$ amplituhedron $\mathcal{A}_{n,k,4}$ is the object most relevant to physics: it encodes the geometry of (tree-level) scattering amplitudes in planar $\mathcal{N} = 4$ SYM. However, the amplituhedron is a well-defined and interesting mathematical object for any m . For example, the $m = 1$ amplituhedron $\mathcal{A}_{n,k,1}$ can be identified with the complex of bounded faces of a cyclic hyperplane arrangement [KW17]. The $m = 2$ amplituhedron $\mathcal{A}_{n,k,2}$, which is a main subject of this paper, also has a beautiful combinatorial structure, and has been recently studied e.g. in [AHTT18, KWZ, BH, LPSV19, Łuk]. From the point of view of physics, $\mathcal{A}_{n,k,2}$ is often considered as a toy-model for the $m = 4$ case. However it has applications to physics as well: $\mathcal{A}_{n,2,2}$ governs the geometry of scattering amplitudes in $\mathcal{N} = 4$ SYM at the subleading order in perturbation theory for the so-called ‘MHV’ sector of the theory, and remarkably, the $m = 2$ amplituhedron $\mathcal{A}_{n,k,2}$ is also relevant for the ‘next to MHV’ sector, enhancing its connection with the geometries of loop amplitudes [KL].

Meanwhile, in recent years physicists have been increasingly interested in understanding how *cluster algebras* encode the analytic properties of scattering amplitudes, both at tree- and loop- level [GG⁺14]. This led them to explore the connection between cluster algebras and the *positive tropical Grassmannian* which was observed in [SW05]. In particular, the positive tropical Grassmannian has been increasingly playing a role in different areas of scattering amplitudes: from bootstrapping loop amplitudes in $\mathcal{N} = 4$ SYM [DFGK, AHHLT, HP] to computing scattering amplitudes in certain scalar theories [CEGM19].

Finally, physicists have already observed a duality between the formulations of scattering amplitudes $\mathcal{N} = 4$ SYM in momentum space¹ and in momentum twistor space. This is possible because of the so-called ‘Amplitude/Wilson loop duality’ [AR08], which was shown to arise from a more fundamental duality in String Theory called ‘T-duality’ [BM08]. The geometric counterpart of this fact is a duality between collections of $4k$ -dimensional ‘BCFW’ cells of $Gr_{k,n}^+$ which (conjecturally) triangulate the amplituhedron $\mathcal{A}_{n,k,4}$, and corresponding

¹More precisely, it is ‘spinor helicity’ space, or, equivalently (related by half-Fourier transform), in twistor space. See [AHBC⁺16, Section 8].

collections of $(2n - 4)$ -dimensional cells of $Gr_{k+2,n}^+$ which (conjecturally) triangulate the *momentum amplituhedron* $\mathcal{M}_{n,k,4}$; the latter object was introduced very recently in [DFLP19]. In this paper we see that this duality, which we have evocatively called *T-duality*, extends beyond $m = 4$. In particular, for $m = 2$, the *hypersimplex* $\Delta_{k+1,n}$ and the $m = 2$ amplituhedron $\mathcal{A}_{n,k,2}$ are somehow dual to each other, a phenomenon that we explore and employ to study properties of both objects. We believe that this duality holds for any (even) m : in Section 12 we introduce a generalization $\mathcal{M}_{n,k,m}$ of the momentum amplituhedron $\mathcal{M}_{n,k,4}$, and a corresponding notion of *T-duality*.

ACKNOWLEDGEMENTS: All three authors would like to thank the Harvard Center for Mathematical Sciences and Applications (CMSA) for its hospitality, and the first and second authors would like to thank the organizers of the “Spacetime and Quantum Mechanics master class workshop” at the CMSA for providing an excellent environment for discussions. Additionally we would like to thank Nick Early, Felipe Rincon, Mario Sanchez, and Melissa Sherman-Bennett for useful comments. The second author would like to acknowledge the support of the ERC grant number 724638, and the third author would like to acknowledge the support of the National Science Foundation under agreements No. DMS-1854316 and No. DMS-1854512. Any opinions, findings and conclusions or recommendations expressed in this material are those of the authors and do not necessarily reflect the views of the National Science Foundation.

2. THE POSITIVE GRASSMANNIAN, THE HYPERSIMPLEX, AND THE AMPLITUHEDRON

In this section we introduce the three main geometric objects in this paper: the positive Grassmannian, the hypersimplex, and the amplituhedron. The latter two objects are images of the positive Grassmannian under the *moment map* and the \tilde{Z} -*map*.

Definition 2.1. The (*real*) *Grassmannian* $Gr_{k,n}$ (for $0 \leq k \leq n$) is the space of all k -dimensional subspaces of \mathbb{R}^n . An element of $Gr_{k,n}$ can be viewed as a $k \times n$ matrix of rank k modulo invertible row operations, whose rows give a basis for the k -dimensional subspace.

Let $[n]$ denote $\{1, \dots, n\}$, and $\binom{[n]}{k}$ denote the set of all k -element subsets of $[n]$. Given $V \in Gr_{k,n}$ represented by a $k \times n$ matrix A , for $I \in \binom{[n]}{k}$ we let $p_I(V)$ be the $k \times k$ minor of A using the columns I . The $p_I(V)$ do not depend on our choice of matrix A (up to simultaneous rescaling by a nonzero constant), and are called the *Plücker coordinates* of V .

2.1. The positive Grassmannian and its cells.

Definition 2.2 ([Pos, Section 3]). We say that $V \in Gr_{k,n}$ is *totally nonnegative* if $p_I(V) \geq 0$ for all $I \in \binom{[n]}{k}$. The set of all totally nonnegative $V \in Gr_{k,n}$ is the *totally nonnegative Grassmannian* $Gr_{k,n}^+$; abusing notation, we will often refer to $Gr_{k,n}^+$ as the *positive Grassmannian*. For $M \subseteq \binom{[n]}{k}$, let S_M be the set of $V \in Gr_{k,n}^+$ with the prescribed collection of Plücker coordinates strictly positive (i.e. $p_I(V) > 0$ for all $I \in M$), and the remaining Plücker coordinates equal to zero (i.e. $p_J(V) = 0$ for all $J \in \binom{[n]}{k} \setminus M$). If $S_M \neq \emptyset$, we call M a *positroid* and S_M its *positroid cell*.

Each positroid cell S_M is indeed a topological cell [Pos, Theorem 6.5], and moreover, the positroid cells of $Gr_{k,n}^{\geq 0}$ glue together to form a CW complex [PSW09].

As shown in [Pos], the cells of $Gr_{k,n}^+$ are in bijection with various combinatorial objects, including *decorated permutations* π on $[n]$ with k anti-excedances, \mathbb{J} -*diagrams* D of type (k, n) , and equivalence classes of *reduced plabic graphs* G of type (k, n) . In Section 14 we review these objects and give bijections between them. This gives a canonical way to label each positroid by a decorated permutation, a \mathbb{J} -diagram, and an equivalence class of plabic graphs; we will correspondingly refer to positroid cells as S_π , S_D , etc.

2.2. The moment map and the hypersimplex. The *moment map* from the Grassmannian $Gr_{k,n}$ to \mathbb{R}^n is defined as follows.

Definition 2.3. Let A be a $k \times n$ matrix representing a point of $Gr_{k,n}$. The *moment map* $\mu : Gr_{k,n} \rightarrow \mathbb{R}^n$ is defined by

$$\mu(A) = \frac{\sum_{I \in \binom{[n]}{k}} |p_I(A)|^2 e_I}{\sum_{I \in \binom{[n]}{k}} |p_I(A)|^2},$$

where $e_I := \sum_{i \in I} e_i \in \mathbb{R}^n$, and $\{e_1, \dots, e_n\}$ is the standard basis of \mathbb{R}^n .

It is well-known that the image of the Grassmannian $Gr_{k,n}$ under the moment map is the (k, n) -*hypersimplex* $\Delta_{k,n}$, which is the convex hull of the points e_I where I runs over $\binom{[n]}{k}$. If one restricts the moment map to $Gr_{k,n}^+$ then the image is again the hypersimplex $\Delta_{k,n}$ [TW15, Proposition 7.10].

We will consider the restriction of the moment map to positroid cells of $Gr_{k,n}^+$.

Definition 2.4. Given a positroid cell S_π of $Gr_{k,n}^+$, we let $\Gamma_\pi^\circ = \mu(S_\pi)$, and $\Gamma_\pi = \overline{\mu(S_\pi)}$.

There are a number of natural questions to ask. What do the Γ_π look like, and how can one characterize them? On which positroid cells is the moment map injective? The images Γ_π of (closures of) positroid cells are called *positroid polytope*; we will explore their nice properties in Section 3.

One of our main motivations is to understand *positroidal dissections* of the hypersimplex.

Definition 2.5. A *positroidal dissection* (or simply a *dissection*) of $\Delta_{k,n}$ is a collection $\mathcal{C} = \{S_\pi\}$ of positroid cells of $Gr_{k,n}^+$, such that:

- $\dim \Gamma_\pi = n - 1$ for each $S_\pi \in \mathcal{C}$
- the images Γ_π° and $\Gamma_{\pi'}$ of two distinct cells in the collection are disjoint
- $\cup_\pi \Gamma_\pi = \Delta_{k,n}$, i.e. the union of the images of the cells is dense in $\Delta_{k,n}$.

We say that a positroidal dissection $\mathcal{C} = \{S_\pi\}$ of $\Delta_{k,n}$ is a *positroidal triangulation* of $\Delta_{k,n}$ if μ is injective on each $S_\pi \in \mathcal{C}$.

Question 2.6. Let $\mathcal{C} = \{S_\pi\}$ be a collection of positroid cells of $Gr_{k,n}^+$. When is \mathcal{C} a positroidal dissection of $\Delta_{k,n}$? When is it a positroidal triangulation?

2.3. The \tilde{Z} -map and the amplituhedron. Building on [AHBC⁺16], Arkani-Hamed and Trnka [AHT14] recently introduced a beautiful new mathematical object called the (*tree*) *amplituhedron*, which is the image of the positive Grassmannian under a map \tilde{Z} induced by a positive matrix Z .

Definition 2.7. For $a \leq b$, define $\text{Mat}_{a,b}^{>0}$ as the set of real $a \times b$ matrices whose $a \times a$ minors are all positive. Let $Z \in \text{Mat}_{k+m,n}^{>0}$, where $m \geq 0$ is fixed with $k + m \leq n$. Then Z induces a map

$$\tilde{Z} : Gr_{k,n}^+ \rightarrow Gr_{k,k+m}$$

defined by

$$\tilde{Z}(\langle v_1, \dots, v_k \rangle) := \langle Z(v_1), \dots, Z(v_k) \rangle,$$

where $\langle v_1, \dots, v_k \rangle$ is an element of $Gr_{k,n}^+$ written as the span of k basis vectors.² The (*tree*) *amplituhedron* $\mathcal{A}_{n,k,m}(Z)$ is defined to be the image $\tilde{Z}(Gr_{k,n}^+)$ inside $Gr_{k,k+m}$.

In special cases the amplituhedron recovers familiar objects. If Z is a square matrix, i.e. $k + m = n$, then $\mathcal{A}_{n,k,m}(Z)$ is isomorphic to the positive Grassmannian. If $k = 1$, then it follows from [Stu88] that $\mathcal{A}_{n,1,m}(Z)$ is a *cyclic polytope* in projective space \mathbb{P}^m . If $m = 1$, then $\mathcal{A}_{n,k,1}(Z)$ can be identified with the complex of bounded faces of a cyclic hyperplane arrangement [KW17].

We will consider the restriction of the \tilde{Z} -map to positroid cells of $Gr_{k,n}^+$.

Definition 2.8. Given a positroid cell S_π of $Gr_{k,n}^+$, we let $Z_\pi^\circ = \tilde{Z}(S_\pi)$, and $Z_\pi = \overline{\tilde{Z}(S_\pi)}$.

As in the case of the hypersimplex, one of our main motivations is to understand *positroidal dissections* of the amplituhedron $\mathcal{A}_{n,k,m}(Z)$.

Definition 2.9. Let $\mathcal{C} = \{S_\pi\}$ be a collection of positroid cells of $Gr_{k,n}^+$. We say that \mathcal{C} is a *positroidal dissection* of $\mathcal{A}_{n,k,m}$ if for any choice of initial data Z , we have that:

- $\dim Z_\pi = mk$ for each $S_\pi \in \mathcal{C}$
- the images Z_π° and $Z_{\pi'}^\circ$ of two distinct cells in the collection are disjoint
- $\cup_\pi Z_\pi = \mathcal{A}_{n,k,m}(Z)$, i.e. the union of the images of the cells is dense in $\mathcal{A}_{n,k,m}(Z)$.

We say that a positroidal dissection $\mathcal{C} = \{S_\pi\}$ of $\mathcal{A}_{n,k,m}$ is a *positroidal triangulation* (or simply a *triangulation*) of $\mathcal{A}_{n,k,m}$ if \tilde{Z} is injective on each $S_\pi \in \mathcal{C}$.

Remark 2.10. One can also consider the weaker notion of a Z -positroidal dissection (or triangulation), for a fixed initial data $Z \in \text{Mat}_{k+m,n}^{>0}$. However, it is expected that the set of triangulations is independent of Z (at least for even m). Moreover the results we prove in this paper are independent of Z . From now on, we will therefore refer to the amplituhedron as $\mathcal{A}_{n,k,m}$ (instead of $\mathcal{A}_{n,k,m}(Z)$).

Question 2.11. Let $\mathcal{C} = \{S_\pi\}$ be a collection of positroid cells of $Gr_{k,n}^+$. When is \mathcal{C} a positroidal dissection of $\mathcal{A}_{n,k,m}$? When is it a positroidal triangulation?

²The fact that Z has positive maximal minors ensures that \tilde{Z} is well defined [AHT14]. See [Kar17, Theorem 4.2] for a more general characterization of when a matrix Z gives rise to a well-defined map \tilde{Z} .

In this paper we will primarily focus on the case $m = 2$ (with the exception of Section 12, where we give some generalizations of our results and conjectures to general even m). (Positroidal) triangulations of the amplituhedron have been studied in [AHT14], [FLOP16], [AHBL17], [KWZ], [GL], [FLP19]. Very recently the paper [BH] constructed (with proof) many triangulations of the $m = 2$ amplituhedron. The $m = 2$ amplituhedron has also been studied in [AHTT18] (which gave an alternative description of it in terms of sign patterns; see also [KWZ]), in [Luk] (which described the boundary stratification of the amplituhedron $\mathcal{A}_{n,k,2}$), and in [LPSV19] (which discussed its relation to cluster algebras). Note that our notion of dissection above includes the notion of subdivision from [GL, Definition 7.1].

3. POSITROID POLYTOPES AND THE MOMENT MAP

In this section we study *positroid polytopes*, which are images of positroid cells of $Gr_{k,n}^+$ under the moment map $\mu : Gr_{k,n}^+ \rightarrow \mathbb{R}^n$. We recall some of the known properties of matroid and positroid polytopes, we give a new characterization of positroid polytopes (see Theorem 3.8), and we describe when the moment map is an injection on a positroid cell, or equivalently, when the moment map restricts to a homeomorphism from the closure of a positroid cell to the corresponding positroid polytope (see Proposition 3.14 and Proposition 3.15).

3.1. Matroid polytopes. The torus $T = \mathbb{R}^n$ acts on $Gr_{k,n}$ by scaling the columns of a matrix representative A . (This is really an $(n-1)$ -dimensional torus since the Grassmannian is a projective variety.) We let TA denote the orbit of A under the action of T , and \overline{TA} its closure. It follows from classical work of Atiyah [Ati82] and Guillemin-Sternberg [GS82] that the image $\mu(\overline{TA})$ is a convex polytope, whose vertices are the images of the torus-fixed points, i.e. the vertices are the points e_I such that $p_I(A) \neq 0$.

This motivates the notion of *matroid polytope*. Note that any full rank $k \times n$ matrix A gives rise to a matroid $M(A) = ([n], \mathcal{B})$, where $\mathcal{B} = \{I \in \binom{[n]}{k} \mid p_I(A) \neq 0\}$.

Definition 3.1. Given a matroid $M = ([n], \mathcal{B})$, the (basis) *matroid polytope* Γ_M of M is the convex hull of the indicator vectors of the bases of M :

$$\Gamma_M := \text{convex}\{e_B \mid B \in \mathcal{B}\} \subset \mathbb{R}^n.$$

The following elegant characterization of matroid polytopes is due to Gelfand, Goresky, MacPherson, and Serganova.

Theorem 3.2 ([GGMS87]). *Let \mathcal{B} be a collection of subsets of $[n]$ and let $\Gamma_{\mathcal{B}} := \text{convex}\{e_B \mid B \in \mathcal{B}\} \subset \mathbb{R}^n$. Then \mathcal{B} is the collection of bases of a matroid if and only if every edge of $\Gamma_{\mathcal{B}}$ is a parallel translate of $e_i - e_j$ for some $i, j \in [n]$.*

The dimension of a matroid polytope is determined by the number of connected components of the matroid. Recall that a matroid which cannot be written as the direct sum of two nonempty matroids is called *connected*.

Proposition 3.3. [Oxl11]. *Let M be a matroid on E . For two elements $a, b \in E$, we set $a \sim b$ whenever there are bases B_1, B_2 of M such that $B_2 = (B_1 - \{a\}) \cup \{b\}$. The relation \sim is an equivalence relation, and the equivalence classes are precisely the connected components of M .*

Proposition 3.4. [BGW03] *For any matroid, the dimension of its matroid polytope is $\dim \Gamma_M = n - c$, where c is the number of connected components of M .*

3.2. Positroid polytopes. In this paper we are interested in *positroids*; these are the matroids $M(A)$ associated to $k \times n$ matrices A with maximal minors all nonnegative.

In Definition 3.1, we defined the matroid polytope Γ_M to be the convex hull of the indicator vectors of the bases of the matroid M . We can of course apply the same definition to any positroid M , obtaining the *positroid polytope* Γ_M . On the other hand, in Definition 2.4, for each positroid cell S_π , we defined $\Gamma_\pi = \overline{\mu(S_\pi)}$ to be the closure of the image of the cell under the moment map. Fortunately these two objects coincide.

Proposition 3.5. [TW15, Proposition 7.10] *Let M be the positroid associated to the positroid cell S_π . Then $\Gamma_M = \Gamma_\pi = \mu(\overline{S_\pi}) = \overline{\mu(S_\pi)}$.*

The first statement in Theorem 3.6 below was proved in [ARW16, Corollary 5.4] (and generalized to the setting of Coxeter matroids in [TW15, Theorem 7.13].) The second statement follows from the proof of [TW15, Theorem 7.13].

Theorem 3.6. *Every face of a positroid polytope is a positroid polytope. Moreover, every face $\Gamma_{\pi'}$ of a positroid polytope Γ_π has the property that $S_{\pi'} \subset \overline{S_\pi}$.*

There is a simple inequality characterization of positroid polytopes.

Proposition 3.7. [ARW16, Proposition 5.7] *A matroid M of rank k on $[n]$ is a positroid if and only if its matroid polytope Γ_M can be described by the equality $x_1 + \dots + x_n = k$ and inequalities of the form*

$$\sum_{\ell \in [i,j]} x_\ell \leq r_{ij}, \quad \text{with } i, j \in [n].$$

Here $[i, j]$ is the cyclic interval given by $[i, j] = \{i, i + 1, \dots, j\}$ if $i < j$ and $[i, j] = \{i, i + 1, \dots, n, 1, \dots, j\}$ if $i > j$.

We now give a new characterization of positroid polytopes. In what follows, we use Sab as shorthand for $S \cup \{a, b\}$, etc.

Theorem 3.8. *Let M be a matroid of rank k on the ground set $[n]$, and consider the matroid polytope Γ_M . It is a positroid polytope (i.e. M is a positroid) if and only if all of its two-dimensional faces are positroid polytopes.*

Moreover, if M fails to be a positroid polytope, then Γ_M has a two-dimensional face F with vertices $e_{Sab}, e_{Sad}, e_{Sbc}, e_{Scd}$, for some $1 \leq a < b < c < d \leq n$ and S of size $k - 2$ disjoint from $\{a, b, c, d\}$.

Remark 3.9. We note that a different characterization of positroids in terms of faces of their matroid polytopes was given in [RVY19, Proposition 6.4], see also [RVY19, Lemma 6.2 and Lemma 6.3]. There are also some related ideas in the proof of [Ear19, Lemma 30].

By Theorem 3.6, every two-dimensional face of Γ_M is a positroid polytope. To prove the other half of Theorem 3.8, we use the following lemma.

Lemma 3.10. *Let M be a matroid of rank k on $[n]$ which has two connected components, i.e. $M = M_1 \oplus M_2$ such that the ground sets of M_1 and M_2 are S and $T = [n] \setminus S$. Suppose that $\{S, T\}$ fails to be a noncrossing partition of $[n]$, in other words, there exists $a < b < c < d$ (in cyclic order) such that $a, c \in S$ and $b, d \in T$. Then Γ_M has a two-dimensional face which is not a positroid polytope; in particular, that face is a square with vertices $e_{Sab}, e_{Sad}, e_{Sbc}, e_{Scd}$, for some $1 \leq a < b < c < d \leq n$ and S of size $k - 2$ disjoint from $\{a, b, c, d\}$.*

Proof. By Proposition 3.3, we have bases Aa and Ac of M_1 and also bases Bb and Bd of M_2 . We can find a linear functional on Γ_{M_1} given by a vector in \mathbb{R}^S whose dot product is maximized on the convex hull of e_{Aa} and e_{Ac} (choose the vector w such that $w_h = 1$ for $h \in A$, $w_h = \frac{1}{2}$ for $h = a$ or $h = c$, and $w_h = 0$ otherwise); therefore there is an edge in Γ_{M_1} between e_{Aa} and e_{Ac} . Similarly, there is an edge in Γ_{M_2} between e_{Bb} and e_{Bd} . Therefore $\Gamma_M = \Gamma_{M_1} \times \Gamma_{M_2}$ has a two-dimensional face whose vertices are $e_{ABab}, e_{ABad}, e_{ABbc}, e_{ABcd}$. This is not a positroid polytope because $\{ab, ad, bc, cd\}$ are not the bases of a rank 2 positroid. \square

Proposition 3.11. *Let M be a connected matroid. If all of the two-dimensional faces of Γ_M are positroid polytopes, then Γ_M is a positroid polytope (i.e. M is a positroid).*

Proof. Suppose for the sake of contradiction that Γ_M is not a positroid polytope.

Since Γ_M is not a positroid polytope, then by Proposition 3.7, it has a facet F of the form $\sum_{i \in S} x_i = r_M(S)$, where S is not a cyclic interval. In other words, S and $T = [n] \setminus S$ fail to form a noncrossing partition. Each facet of Γ_M is the matroid polytope of a matroid with two connected components, so by the greedy algorithm for matroids (see e.g. [ARW16, Proposition 2.12]), F must be the matroid polytope of $M|_S \oplus M/S$. But now by Lemma 3.10, F has a two-dimensional face which is not a positroid polytope. \square

We now complete the proof of Theorem 3.8.

Proof. We start by writing M as a direct sum of connected matroids $M = M_1 \oplus \dots \oplus M_l$. Let S_1, \dots, S_l be the ground sets of M_1, \dots, M_l . By [ARW16, Lemma 7.3], either one of the M_i 's fails to be a positroid, or $\{S_1, \dots, S_l\}$ fails to be a non-crossing partition of $[n]$. If one of the M_i 's fails to be a positroid, then by Proposition 3.11, Γ_{M_i} has a two-dimensional face which fails to be a positroid. But then so does $\Gamma_M = \Gamma_{M_1} \times \dots \times \Gamma_{M_l}$. On the other hand, if $\{S_1, \dots, S_l\}$ fails to be a non-crossing partition of $[n]$, then by Lemma 3.10, Γ_M has a two-dimensional face which fails to be a positroid. This completes the proof. \square

Our next goal is to use Proposition 3.4 to determine when the moment map restricted to a positroid cell is a homeomorphism. To do so, we need to understand how to compute the number of connected components of a positroid. The following result comes from [ARW16, Theorem 10.7] and its proof. We say that a permutation π of $[n]$ is *stabilized-interval-free (SIF)* if it does not stabilize any proper interval of $[n]$; that is, $\pi(I) \neq I$ for all intervals $I \subsetneq [n]$.

Proposition 3.12. *Let S_π be a positroid cell of $Gr_{k,n}^+$ and let M_π be the corresponding positroid. Then M_π is connected if and only if π is a SIF permutation of $[n]$. More generally, the number of connected components of M_π equals the number of connected components of any reduced plabic graph associated to π .*

Example 3.13. Consider the permutation $\pi = (5, 3, 4, 2, 6, 7, 1)$ (which in cycle notation is $(234)(1567)$). Then there are two minimal-by-inclusion cyclic intervals such that $\pi(I) = I$, namely $[2, 4]$ and $[5, 1]$, and hence the matroid M_π has two connected components. (Note that $[1, 7]$ is also a cyclic interval with $\pi([1, 7]) = [1, 7]$ but it is not minimal-by-inclusion.) \diamond

Proposition 3.14. *Consider a positroid cell $S_\pi \subset Gr_{k,n}^+$ and let M_π be the corresponding positroid. Then the following statements are equivalent:*

- (1) *the moment map restricts to an injection on S_π*
- (2) *the moment map is a homeomorphism from $\overline{S_\pi}$ to Γ_π*
- (3) *$\dim S_\pi = \dim \Gamma_\pi = n - c$, where c is the number of connected components of the matroid M_π .*

Proof. Suppose that (1) holds, i.e. that the moment map is an injection when restricted to a cell S_π . Then $\dim \Gamma_\pi = \dim S_\pi$. By [TW15, Proposition 7.12], the positroid variety X_π is a toric variety if and only if $\dim \Gamma_\pi = \dim S_\pi$, so this implies that X_π is a toric variety, and $\overline{S_\pi}$ is its nonnegative part. It is well-known that the moment map is a homeomorphism when restricted to the nonnegative part of a toric variety [Ful93, Section 4.2], so it follows that μ is a homeomorphism on $\overline{S_\pi}$. Therefore (1) implies (2). But obviously (2) implies (1).

Now suppose that (2) holds. Since Γ_π is the moment map image of $\overline{S_\pi}$, it follows that $\dim \Gamma_\pi = \dim S_\pi$, and by Proposition 3.4, we have that $\dim \Gamma_\pi = n - c$, where c is the number of connected components of the matroid M_π . Therefore (2) implies (3).

Now suppose (3) holds. Then by [TW15, Proposition 7.12], X_π must be a toric variety, and so the moment map restricts to a homeomorphism from $\overline{S_\pi}$ to Γ_π . So (3) implies (2). \square

Proposition 3.15. *Consider a positroid cell $S_\pi \subset Gr_{k,n}^+$ and let M_π be the corresponding positroid. Then the moment map is a homeomorphism from $\overline{S_\pi}$ to $\Gamma_\pi \subset \mathbb{R}^n$ if and only if any reduced plabic graph associated to π is a forest. The $(n - 1)$ -dimensional cells S_π on which the moment map is a homeomorphism to their image are precisely those cells whose reduced plabic graphs are trees.*

Proof. This follows from Proposition 3.14 and Proposition 3.12, together with the fact that we can read off the dimension of a positroid cell from any reduced plabic graph G for it as the number of regions of G minus 1. \square

Remark 3.16. The connected $(n - 1)$ -dimensional positroid cells S_π of $Gr_{k,n}^+$ are precisely those $(n - 1)$ -dimensional cells where π is a single cycle of length n .

4. DISSECTING THE HYPERSIMPLEX AND THE AMPLITUHEDRON

In this section we provide two recursive recipes for dissecting the hypersimplex $\Delta_{k+1,n}$, and dissecting the amplituhedron $\mathcal{A}_{n,k,2}$; the second recipe was proved in [BH]. These recursive recipes are completely parallel: as we will see in Section 5, the cells of corresponding dissections are in bijection with each other via the *T-duality map* on positroid cells.

4.1. A recursion for dissecting the hypersimplex.

Definition 4.1. Consider the set of reduced plabic graphs with $n - 1$ boundary vertices, associated to cells of $Gr_{k+1,n-1}^+$ (respectively, $Gr_{k,n-1}^+$), which do not have a loop at vertex $n - 1$. Let \mathbf{i}_{pre} (respectively, \mathbf{i}_{inc}) be the map on these graphs, which takes a reduced plabic graph G and replaces the $(n - 1)$ st boundary vertex with a trivalent internal white (resp. black) vertex attached to boundary vertices $n - 1$ and n , as in the middle (resp. rightmost) graph of Figure 1. Using Section 14, it is straightforward to verify that both $\mathbf{i}_{\text{pre}}(G)$ and $\mathbf{i}_{\text{inc}}(G)$ are reduced plabic graphs for cells of $Gr_{k+1,n}^+$.³

Abusing notation slightly, we also use \mathbf{i}_{pre} and \mathbf{i}_{inc} to denote the corresponding maps on positroid cells, decorated permutations, \mathbb{J} -diagrams, etc. Using Definition 14.9 and Definition 14.3, it is easy to determine the effect of \mathbf{i}_{pre} and \mathbf{i}_{inc} on decorated permutations and \mathbb{J} -diagrams. We leave the proof of the following lemma as an exercise.

Lemma 4.2. *Let $\pi = (a_1, a_2, \dots, a_{n-1})$ be a decorated permutation on $n - 1$ letters; assume that $(n - 1) \mapsto a_{n-1}$ is not a black fixed point. Then $\mathbf{i}_{\text{pre}}(\pi) = (a_1, a_2, \dots, a_{n-2}, n, a_{n-1})$. If D is the \mathbb{J} -diagram associated to π , then $\mathbf{i}_{\text{pre}}(D)$ is obtained from D by adding a new column to the left of D , where the new column consists of a single $+$ at the bottom.*

Let $\pi = (a_1, a_2, \dots, a_{n-1})$ be a decorated permutation; assume that $(n - 1) \mapsto a_{n-1}$ is not a white fixed point. Let $j = \pi^{-1}(n - 1)$. Then $\mathbf{i}_{\text{inc}}(\pi) = (a_1, a_2, \dots, a_{j-1}, n, a_{j+1}, \dots, a_{n-1}, n - 1)$. If D is the \mathbb{J} -diagram associated to π , then $\mathbf{i}_{\text{inc}}(D)$ is obtained from D by adding a new row at the bottom of D , where the row consists of a single box containing a $+$.

Theorem 4.3. *Let $\mathcal{C}_{k+1,n-1}$ (respectively $\mathcal{C}_{k,n-1}$) be a collection of cells in $Gr_{k+1,n-1}^+$ (resp. $Gr_{k,n-1}^+$) which dissects the hypersimplex $\Delta_{k+1,n-1}$ (resp. $\Delta_{k,n-1}$). Then*

$$\mathcal{C}_{k+1,n} = \mathbf{i}_{\text{pre}}(\mathcal{C}_{k+1,n-1}) \cup \mathbf{i}_{\text{inc}}(\mathcal{C}_{k,n-1})$$

dissects $\Delta_{k+1,n}$.

Diagrammatically, the main theorem reads as follows:

Remark 4.4. Because of the cyclic symmetry of the positive Grassmannian and the hypersimplex (see e.g. Theorem 7.4) there are $n - 1$ other versions of Theorem 4.3 (and Figure 1) in which all plabic graph labels get shifted by i modulo n (for $1 \leq i \leq n - 1$).

Proof. The hypersimplex $\Delta_{k+1,n}$ is cut out by the inequalities $0 \leq x_i \leq 1$, as well as the equality $\sum_i x_i = k + 1$. We will show that Figure 1 represents the partition of $\Delta_{k+1,n}$ into two pieces, with the middle graph representing the piece cut out by $x_{n-1} + x_n \leq 1$, and the rightmost graph representing the piece cut out by $x_{n-1} + x_n \geq 1$.

Towards this end, it follows from Proposition 14.7 that if G is a reduced plabic graph representing a cell of $Gr_{k+1,n-1}^+$, such that the positroid M_G has bases \mathcal{B} , then the bases of $M_{\mathbf{i}_{\text{pre}}(G)}$ are precisely $\mathcal{B} \sqcup \{(B \setminus \{n - 1\}) \cup \{n\} \mid B \in \mathcal{B}, n - 1 \in B\}$. In particular, each basis of $M_{\mathbf{i}_{\text{pre}}(G)}$ may contain at most one element of $\{n - 1, n\}$.

³We can in fact define $\mathbf{i}_{\text{pre}}(G)$ (resp. $\mathbf{i}_{\text{inc}}(G)$) on any reduced plabic graph for $Gr_{k+1,n-1}^+$ (resp. $Gr_{k,n-1}^+$) which does not have a black (resp. white) lollipop at vertex $n - 1$, and will again have that $\mathbf{i}_{\text{pre}}(G)$ and $\mathbf{i}_{\text{inc}}(G)$ represent cells of $Gr_{k+1,n}^+$.

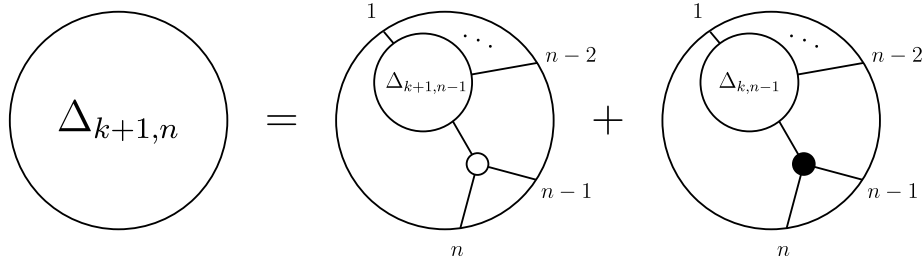
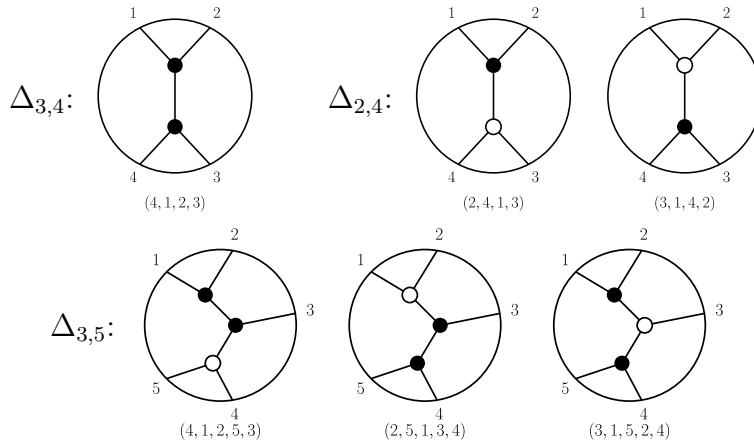

FIGURE 1. A recursion for dissecting the hypersimplex. There is a parallel recursion obtained from this one by cyclically shifting all boundary vertices of the plabic graphs by i (modulo n).

Meanwhile, it follows from Proposition 14.7 that if G is a reduced plabic graph representing a cell of $Gr_{k,n-1}^+$, such that the positroid M_G has bases \mathcal{B} , then the bases of $M_{i_{\text{inc}}(G)}$ are precisely $\{B \cup \{n\} \mid B \in \mathcal{B}\} \sqcup \{B \cup \{n-1\} \mid B \in \mathcal{B}, n-1 \notin B\}$. In particular, each basis of $M_{i_{\text{inc}}(G)}$ must contain at least one element of $\{n-1, n\}$.

It is now a straightforward exercise (using e.g. [ARW16, Proposition 5.6]) to determine that if $\mathcal{C}_{k+1,n-1}$ is a collection of cells in $Gr_{k+1,n-1}^+$ which dissects $\Delta_{k+1,n-1}$ then $i_{\text{pre}}(\mathcal{C}_{k+1,n-1})$ dissects the subset of $\Delta_{k+1,n}$ cut out by the inequality $x_{n-1} + x_n \leq 1$. Similarly for $i_{\text{inc}}(\mathcal{C}_{k,n-1})$ and the subset of $\Delta_{k+1,n}$ cut out by $x_{n-1} + x_n \geq 1$. \square

Example 4.5. Let $n = 5$ and $k = 2$. We will use Theorem 4.3 to obtain a dissection of $\Delta_{k+1,n} = \Delta_{3,5}$. We start with a dissection of $\Delta_{3,4}$ coming from the plabic graph shown below (corresponding to the decorated permutation $(4, 1, 2, 3)$), and a dissection of $\Delta_{2,4}$ (corresponding to the permutations $(2, 4, 1, 3)$ and $(3, 1, 4, 2)$). Applying the theorem leads to the three plabic graphs in the bottom line, which correspond to the permutations $(4, 1, 2, 5, 3)$, $(2, 5, 1, 3, 4)$, $(3, 1, 5, 2, 4)$.



\diamond

Remark 4.6. It is worth pointing out that the recursion does not provide all possible dissections of the hypersimplex. This comes from the fact that in each step of the recursion we divide the hypersimplex into two pieces, while there are some dissections coming from

3-splits. The simplest example of a dissection which cannot be obtained from the recursion can be found already for $\Delta_{3,6}$ and is depicted in Figure 2.

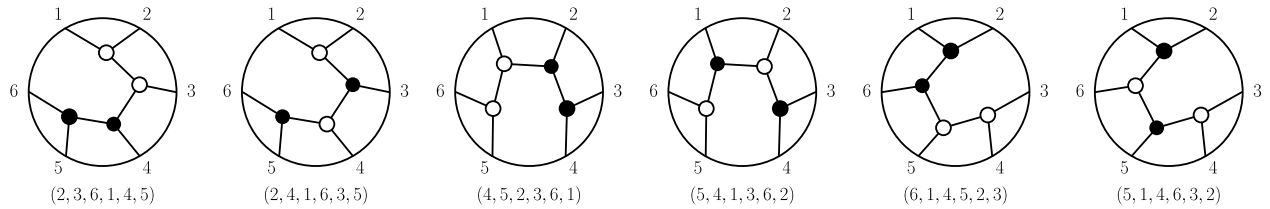

FIGURE 2. An example of dissection of $\Delta_{3,6}$ that cannot be obtained from the recursion in Theorem 4.3.

4.2. A recursion for dissecting the $m = 2$ amplituhedron. We now introduce some maps on plabic graphs, and recall a result of Bao and He [BH].

Definition 4.7. Consider the set of reduced plabic graphs with $n - 1$ boundary vertices, associated to cells of $Gr_{k,n-1}^+$. Let ι_{pre} be the map which takes such a graph G and adds a black lollipop at a new boundary vertex n , as shown in the middle graph of Figure 3. Clearly the resulting graph $\iota_{\text{pre}}(G)$ is a reduced plabic graph for a cell of $Gr_{k,n}^+$.

Similarly, let ι_{inc} be the map on plabic graphs for $Gr_{k-1,n-1}^+$ which modifies such a graph G , changing the graph locally around vertices $1, n, n - 1$, as shown at the right of of Figure 3 (in physics lore it corresponds to attaching an inverse soft factor). It is not hard to show that (as long as G does not have white fixed points at vertices 1 or $n - 1$) then $\iota_{\text{inc}}(G)$ is a reduced plabic graph for a cell of $Gr_{k,n}^+$.

Abusing notation slightly, we also use ι_{pre} and ι_{inc} to denote the corresponding maps on positroid cells, decorated permutations, \mathbb{J} -diagrams, etc. Using Definition 14.9 and Definition 14.3, it is easy to determine the effect of ι_{pre} and ι_{inc} on decorated permutations and \mathbb{J} -diagrams. We leave the proof of the following lemma as an exercise.

Lemma 4.8. *Let $\pi = (a_1, a_2, \dots, a_{n-1})$ be a decorated permutation on $n - 1$ letters. Then $\iota_{\text{pre}}(\pi) = (a_1, a_2, \dots, a_{n-2}, a_{n-1}, n)$, where n is a black fixed point. If D is the \mathbb{J} -diagram associated to π , then $\iota_{\text{pre}}(D)$ is obtained from D by adding a new all-zero column to the left of D .*

Let $\pi = (a_1, a_2, \dots, a_{n-1})$ be a decorated permutation; assume that neither positions 1 nor $n - 1$ are white fixed points. Let $h = \pi^{-1}(n - 1)$. Then $\iota_{\text{inc}}(\pi)$ is the permutation such that $1 \mapsto n - 1$, $h \mapsto n$, $n \mapsto a_1$, and $j \mapsto a_j$ for all $j \neq 1, h, n$.

The construction below is closely related to the recursion from [KWZ, Definition 4.4], which is a sort of $m = 2$ version of the BCFW recurrence.

Theorem 4.9. [BH, Theorem A] *Let $\mathcal{C}_{n-1,k,2}$ (respectively $\mathcal{C}_{n-1,k-1,2}$) be a collection of cells in $Gr_{k,n-1}^+$ (resp. $Gr_{k-1,n-1}^+$) which dissects the $m = 2$ amplituhedron $\mathcal{A}_{n-1,k,2}$ (resp. $\mathcal{A}_{n-1,k-1,2}$). Then*

$$\mathcal{C}_{n,k,2} = \iota_{\text{pre}}(\mathcal{C}_{n-1,k,2}) \cup \iota_{\text{inc}}(\mathcal{C}_{n-1,k-1,2})$$

dissects $\mathcal{A}_{n,k,2}$.

Diagrammatically, the main theorem reads as follows:

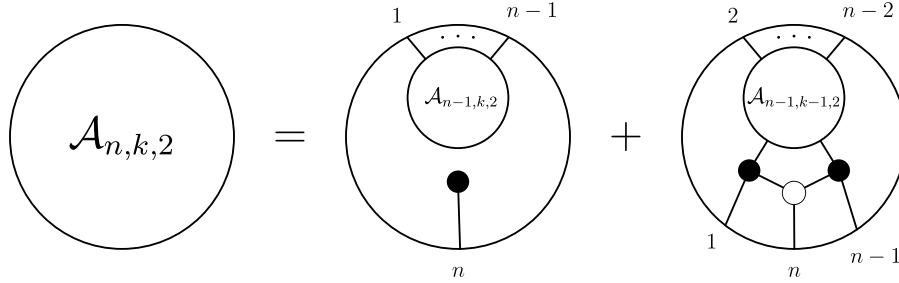
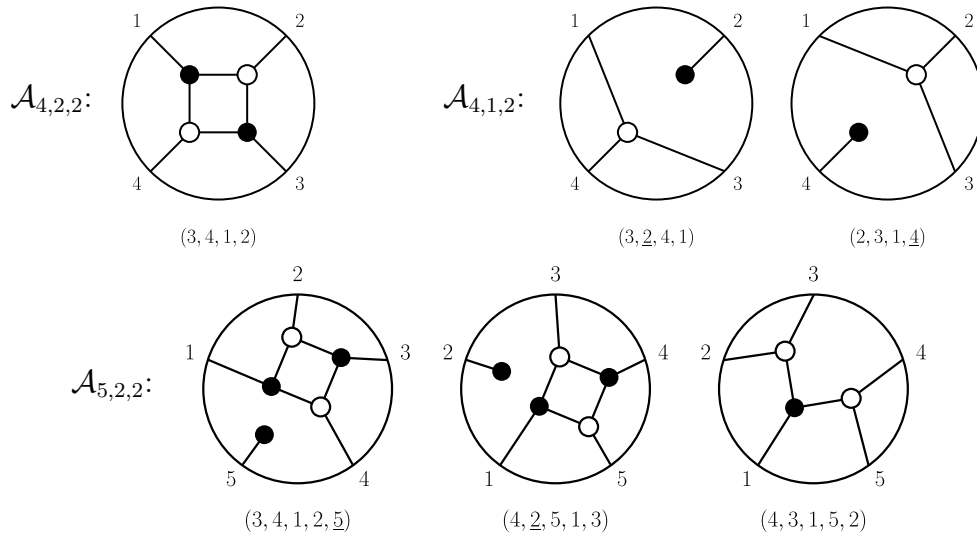

FIGURE 3. A recursion for dissecting the amplituhedron. There is a parallel recursion obtained from this one by cyclically shifting all boundary vertices of the plabic graphs by i (modulo n).

Remark 4.10. Because of the cyclic symmetry of the positive Grassmannian and the amplituhedron (see e.g. Theorem 7.5) there are $n - 1$ other versions of Theorem 4.3 (and Figure 1) in which all plabic graph labels get shifted by i modulo n (for $1 \leq i \leq n - 1$).

Note that [BH] worked in the setting of *triangulations* – i.e. they were only considering collections of cells that map injectively from the positive Grassmannian to the amplituhedron – but Theorem 4.9 holds in the more general setting of dissections.

Example 4.11. Let $n = 5$ and $k = 2$. We will use Theorem 4.9 to obtain a dissection of $\mathcal{A}_{n,k,2} = \mathcal{A}_{5,2,2}$. We start with a dissection of $\mathcal{A}_{4,2,2}$ coming from the plabic graph shown below (corresponding to the decorated permutation $(3, 4, 1, 2)$), and a dissection of $\mathcal{A}_{4,1,2}$ (corresponding to the permutations $(3, \underline{2}, 4, 1)$ and $(2, 3, 1, \underline{4})$). Applying the theorem leads to the three plabic graphs in the bottom line, which correspond to the permutations $(3, 4, 1, 2, \underline{5})$, $(4, \underline{2}, 5, 1, 3)$, $(4, 3, 1, 5, 2)$.



◇

5. THE T-DUALITY MAP

In this section we define the *T-duality map* (previously defined in [KWZ, Definition 4.5]), from certain positroid cells of $Gr_{k+1,n}^+$ to positroid cells of $Gr_{k,n}^+$, and we prove many remarkable properties of it. We will subsequently explain, in Theorem 6.5, how the T-duality map gives a correspondence between triangulations (and more generally dissections) of the hypersimplex $\Delta_{k+1,n}$ and the amplituhedron $\mathcal{A}_{n,k,2}$.

To get a preview of the phenomenon we will illustrate, compare the decorated permutations labelling the plabic graphs in Example 4.5 and Example 4.11; can you spot the correspondence? (This correspondence will be explained in Theorem 6.5.)

5.1. T-duality as a map on permutations.

Definition 5.1. We define the *T-duality map* from loopless decorated permutations on $[n]$ to coloopless decorated permutations on $[n]$ as follows. Given a loopless decorated permutation $\pi = (a_1, a_2, \dots, a_n)$ (written in list notation) on $[n]$, we define the decorated permutation $\hat{\pi}$ by $\hat{\pi}(i) = \pi(i-1)$, so that $\hat{\pi} = (a_n, a_1, a_2, \dots, a_{n-1})$, where any fixed points in $\hat{\pi}$ are declared to be loops. Equivalently, $\hat{\pi}$ is obtained from π by composing π with the permutation $\pi_0 = (n, 1, 2, \dots, n-1)$ in the symmetric group, $\hat{\pi} = \pi_0 \circ \pi$.

Recall that an anti-excedance of a decorated permutation is a position i such that $\pi(i) < i$, or $\pi(i) = i$ and i is a coloop. Our first result shows that T-duality is a bijection between loopless cells of $Gr_{k+1,n}^+$ and coloopless cells of $Gr_{k,n}^+$.

Lemma 5.2. *The T-duality map $\pi \mapsto \hat{\pi}$ is a bijection between the loopless permutations on $[n]$ with $k+1$ anti-excedances, and the coloopless permutations on $[n]$ with k anti-excedances. Equivalently, the T-duality map is bijection between loopless positroid cells of $Gr_{k+1,n}^+$ and coloopless positroid cells of $Gr_{k,n}^+$.*

Proof. The second statement follows from the first by Section 14, so it suffices to prove the first statement. Let $\pi = (a_1, \dots, a_n)$ be a loopless permutation on $[n]$ with $k+1$ anti-excedances; then $\hat{\pi} = (a_n, a_1, \dots, a_{n-1})$. Consider any i such that $1 \leq i \leq n-1$. Suppose i is a position of a anti-excedance, i.e. either $a_i < i$ or $a_i = \bar{i}$. Then the letter a_i appears in the $(i+1)$ st position in $\hat{\pi}$, and since $a_i < i+1$, we again have an anti-excedance. On the other hand, if i is *not* a position of an anti-excedance, i.e. $a_i > i$ (recall that π is loopless), then in the $(i+1)$ st position of $\hat{\pi}$ we have $a_i \geq i+1$. By Definition 5.1 if we have a fixed point in position $i+1$ (i.e. $a_i = i+1$) this is a loop, and so position $i+1$ of $\hat{\pi}$ will not be a anti-excedance. Therefore if $I \subset [n-1]$ is the positions of the anti-excedances located in the first $n-1$ positions of π , then $I+1$ is the positions of the anti-excedances located in positions $\{2, 3, \dots, n\}$ in $\hat{\pi}$.

Now consider position n of π . Because π is loopless, n will be the position of a anti-excedance in π . And because $\hat{\pi}$ is defined to be coloopless, 1 will never be the position of a anti-excedance in $\hat{\pi}$. Therefore the number of anti-excedances of $\hat{\pi}$ will be precisely one less than the number of anti-excedances of π .

It is easy to reverse this map so it is a bijection. □

Remark 5.3. Since by Lemma 5.2 the map $\pi \mapsto \hat{\pi}$ is a bijection, we can also talk about the inverse map from coloopless permutations on $[n]$ with k anti-excedances to loopless permutations on $[n]$ with $k + 1$ anti-excedances. We denote this inverse map by $\pi \mapsto \tilde{\pi}$.

Remark 5.4. Our map $\pi \mapsto \hat{\pi}$ is in fact a special case of the map ρ_A introduced by Benedetti-Chavez-Tamayo in [BCT, Definition 23] (in the case where $A = \emptyset$).

5.2. T-duality as a map on cells. While we have defined the T-duality map as a map $\pi \mapsto \hat{\pi}$ on the permutations labelling positroid cells, it can be shown that it is induced from a map on the corresponding cells. We will follow here the derivation in [AHBC⁺16] and define a Q -map which maps elements of the positroid cell S_π of $Gr_{k+1,n}^+$ to the positroid cell $S_{\hat{\pi}}$ of $Gr_{k,n}^+$. Note that in much of this section we allow m to be any positive even integer.

Definition 5.5. Let $\lambda \in Gr_{\frac{m}{2},n}$. We say that λ is *generic* if $p_I(\lambda) \neq 0$ for all $I \in \binom{[n]}{\frac{m}{2}}$.

For $m = 2$, $\lambda = (\lambda_1, \lambda_2, \dots, \lambda_n) \in \mathbb{R}^n$ is generic in \mathbb{R}^n if $\lambda_i \neq 0$ for all $i = 1, \dots, n$.

Lemma 5.6. Given $C = (c_1, c_2, \dots, c_n) \in Gr_{k+\frac{m}{2},n}$ where c_i are column vectors, then C contains a generic $\frac{m}{2}$ -plane if and only if $\text{rank}(\{c_i\}_{i \in I}) = \frac{m}{2}$ for all $I \in \binom{[n]}{\frac{m}{2}}$.

Proof. If a generic $\frac{m}{2}$ -plane $\lambda \in M(\frac{m}{2}, n)$ is contained in C , then there is a matrix $h \in M(\frac{m}{2}, k + \frac{m}{2})$ such that $\lambda = h \cdot C$. Then $p_I(\lambda) = \sum_{J \in \binom{[k+\frac{m}{2}]}{\frac{m}{2}}} p_J(h) C_J^I$, with $I \in \binom{[n]}{\frac{m}{2}}$. If $\text{rank}(\{c_i\}_{i \in I}) = \frac{m}{2}$ then there exist $J_I \in \binom{[k+\frac{m}{2}]}{\frac{m}{2}}$ such that $C_{J_I}^I \neq 0$, therefore it is enough to choose h such that $p_{J_I}(h) \neq 0$ in order to guarantee $\lambda = h \cdot C$ is generic. Vice-versa if we assume $\text{rank}(\{c_i\}_{i \in I}) < \frac{m}{2}$ then $C_J^I = 0$ for all $J \in \binom{[k+\frac{m}{2}]}{\frac{m}{2}}$ and this would imply $p_I(\lambda) = 0$. \square

In the $m = 2$ case we have the following statement. Note that such a generic vector can be found by adding the row vectors in the matrix given by Theorem 14.11.

Lemma 5.7. Let S_π be a positroid cell in $Gr_{k+1,n}^+$. Then S_π is loopless if and only if every vector space $V \in S_\pi$ contains a generic vector.

Lemma 5.8. Given a positroid cell S_π , if every vector space $V \in S_\pi$ contains a generic $\frac{m}{2}$ -plane then $\pi(i) \geq i + \frac{m}{2}$ (as affine permutation, see Definition 14.2) is satisfied.

Proof. Let us assume it exists a such that $\pi(a) = a + \frac{m}{2} - 1$, then $c_a \in \text{span}\{c_{a+1}, \dots, c_{a+\frac{m}{2}-1}\}$ and, in particular, $r[a; a + \frac{m}{2} - 1] < \frac{m}{2}$. The proof follows immediately from Lemma 5.8. \square

Definition 5.9. For a positroid cell $S_\pi \subset Gr_{k+\frac{m}{2},n}^+$ and $\lambda \in Gr_{\frac{m}{2},n}$ a generic vector of an element $V \in S_\pi$, we define

$$S_\pi^{(\lambda)} := \{W \in S_\pi : \lambda \subset W\}.$$

Let $C_\pi^{(\lambda)}$ be matrix representatives for elements in $S_\pi^{(\lambda)}$. It is always possible to find an invertible row transformation which bring $C_\pi^{(\lambda)}$ into the form

$$(5.10) \quad C_\pi^{(\lambda)} = \begin{pmatrix} \lambda_{11} & \lambda_{12} & \cdots & \lambda_{1n} \\ \vdots & \vdots & \ddots & \vdots \\ \lambda_{\frac{m}{2}1} & \lambda_{\frac{m}{2}2} & \cdots & \lambda_{\frac{m}{2}n} \\ c_{\frac{m}{2}+11} & c_{\frac{m}{2}+12} & \cdots & c_{\frac{m}{2}+1n} \\ \vdots & \vdots & \ddots & \vdots \\ c_{\frac{m}{2}+k1} & c_{\frac{m}{2}+k2} & \cdots & c_{\frac{m}{2}+kn} \end{pmatrix}$$

Let us define a linear transformation $Q^{(\lambda)} : \mathbb{R}^n \mapsto \mathbb{R}^n$ represented by the $n \times n$ matrix $Q^{(\lambda)} = Q_{ab}^{(\lambda)}$ as⁴

$$(5.11) \quad Q_{ab}^{(\lambda)} = \sum_{i=0}^{\frac{m}{2}} (-1)^i \delta_{a, b - \frac{m}{2} + i} p_{b - \frac{m}{2}, \dots, b - \frac{m}{2} + i, \dots, b}^{(\lambda)}$$

The matrix $Q^{(\lambda)}$ has rank $n - \frac{m}{2}$. Let us define $\hat{C}_\pi^{(\lambda)} = C_\pi^{(\lambda)} \cdot Q^{(\lambda)}$, then

$$(5.12) \quad \hat{C}_\pi^{(\lambda)} = \begin{pmatrix} 0 & 0 & \cdots & 0 \\ \vdots & \vdots & \ddots & \vdots \\ 0 & 0 & \cdots & 0 \\ \hat{c}_{\frac{m}{2}+11} & \hat{c}_{\frac{m}{2}+12} & \cdots & \hat{c}_{\frac{m}{2}+1n} \\ \vdots & \vdots & \ddots & \vdots \\ \hat{c}_{\frac{m}{2}+k1} & \hat{c}_{\frac{m}{2}+k2} & \cdots & \hat{c}_{\frac{m}{2}+kn} \end{pmatrix}$$

It is easy to check that $\text{span}\{\hat{c}_a, \dots, \hat{c}_b\} \subset \text{span}\{c_{a-\frac{m}{2}}, \dots, c_b\}$ and moreover that for consecutive maximal minors we have: $(a - \frac{m}{2}, \dots, a, \dots, a+k-1)_C$ is proportional to $(a, \dots, a+k-1)_{\hat{C}}$. Then, the matrix $Q^{(\lambda)}$ projects elements of $S_\pi^{(\lambda)}$ into $S_{\hat{\pi}}$, with

$$(5.13) \quad \hat{\pi}(i) = \pi(i - \frac{m}{2})$$

The proof of this fact closely follows the one found in [AHBC⁺16, page 75].

For $m = 2$ we get the explicit form of $Q^{(\lambda)}$

$$(5.14) \quad Q_{ab}^{(\lambda)} = \delta_{a, b-1} \lambda_b - \delta_{a, b} \lambda_{b-1},$$

and the following relation between consecutive minors

$$(5.15) \quad (a, a+1, \dots, a+k-1)_{\hat{C}} = (-1)^k \lambda_a \dots \lambda_{a+k-2} (a-1, a, \dots, a+k-1)_C$$

Remark 5.16. In order for the T-duality map to be a well-defined (on affine permutations), we require that both $i \leq \pi(i) \leq n+i$ and $i \leq \hat{\pi}(i) \leq n+i$ are satisfied. Given that $\hat{\pi}(i) = \pi(i - \frac{m}{2})$, this implies extra conditions on allowed permutations, i.e. $\pi(i) \geq i + \frac{m}{2}$ and $\hat{\pi}(i) \leq i + a - \frac{m}{2}$. We observe that the operation in (5.13) is then well-defined for the cells

⁴Notice that our definition differs from the one found in [AHBC⁺16] for $m = 4$. They are however related to each other by a cyclic shift and rescaling each column of $Q^{(\lambda)}$.

S_π^λ , by Lemma 5.8. Finally, for $m = 2$ these conditions correspond to lack of loops (resp. coloops) for π (reps. $\hat{\pi}$).

5.3. How T-duality affects the dimension of positroid cells.

Proposition 5.17. *Let S_π be a loopless cell of $Gr_{k+1,n}^+$. Then $S_{\hat{\pi}}$ is a coloopless cell of $Gr_{k,n}^+$, and $\dim(S_{\hat{\pi}}) - 2k = \dim(S_\pi) - (n - 1)$. In particular, if $\dim S_\pi = n - 1$, then $\dim S_{\hat{\pi}} = 2k$.*

Proof. The proof is analogous to the proof of a similar statement given in [AHBC⁺16, pages 75-76]. In particular, there is an analogous calculation in [AHBC⁺16, (8.28)] which we can mimic here. Let $C_\pi = \{c_1, c_2, \dots, c_n\}$ be a matrix associated to a positroid cell S_π , where c_a are column vectors. Then using the notation of (5.12), the dimension of S_π can be calculated using

$$(5.18) \quad \dim(S_\pi) = \sum_{a=1}^n r[a, \pi(a)] - k^2$$

where $r[a, b] = \text{rank}\{c_a, c_{a+1}, \dots, c_b\}$ and we assume cyclic ordering. Now, since $\text{span}\{\hat{c}_a, \dots, \hat{c}_b\} \subset \text{span}\{c_{a-1}, \dots, c_b\}$, one can check that the rank of each chain $\hat{r}[a+1; \hat{\pi}(a+1)]$ is lowered by 1 relative to $r[a; \pi(a)]$. Then using (5.18) we see that:

$$(5.19) \quad \dim(S_{\hat{\pi}}) = \dim(S_\pi) - n + (k+1)^2 - k^2 = \dim(S_\pi) - n + 2k + 1$$

and therefore

$$(5.20) \quad \dim(S_{\hat{\pi}}) - 2k = \dim(S_\pi) - (n - 1).$$

□

6. T-DUALITY RELATES TRIANGLES, TRIANGULATIONS, AND DISSECTIONS

In this section we will compare the “generalized triangles” and triangulations (and more generally, dissections) of the hypersimplex $\Delta_{k+1,n}$ with those of the amplituhedron $\mathcal{A}_{n,k,2}$. Again, we will see that T-duality connects them!

The $2k$ -dimensional cells of $Gr_{k,n}^+$ which have full-dimensional image in $\mathcal{A}_{n,k,2}$ were studied in [LPSV19] and called *generalized triangles*. In this paper we will refer to the above objects as *weak generalized triangles*, and re-define generalized triangles as follows.

Definition 6.1. Let S_π be a $2k$ -dimensional cell of $Gr_{k,n}^+$ such that $\dim \tilde{Z}(S_\pi) = \dim S_\pi$. Then we say its image $\tilde{Z}(S_\pi)$ in $\mathcal{A}_{n,k,2}$ is a *weak generalized triangle* in $\mathcal{A}_{n,k,2}$. If additionally the restriction of \tilde{Z} to S_π is an injection, we say that $\tilde{Z}(S_\pi)$ is a *generalized triangle* in $\mathcal{A}_{n,k,2}$.

A conjectural description of weak generalized triangles was given in [LPSV19]:

Definition 6.2. We say that a collection of convex polygons (which have p_1, \dots, p_r vertices) inscribed in a given n -gon is a collection of k *non-intersecting triangles in an n -gon* if each pair of such polygons intersects in at most a vertex and if the total number of triangles needed to triangulate all polygons in the collection is k , i.e. $(p_1 - 2) + \dots + (p_r - 2) = k$.

It was experimentally checked in [LPSV19] that weak generalized triangles in $\mathcal{A}_{n,k,2}$ are in bijection with collections of ‘ k non-intersecting triangles in a n -gon’. Moreover, one can read off the cell S_π of $Gr_{k,n}^+$ corresponding to a weak generalized triangle of $\mathcal{A}_{n,k,2}$ using the combinatorics of the collection of k non-intersecting triangles in an n -gon, see [LPSV19, Section 2.4]. The basic idea is to associate a row vector to each of the non-intersecting triangles, with generic entries at the positions of the triangle vertices (and zeros everywhere else). This way one constructs a $k \times n$ matrix whose matroid is the matroid for S_π .

Borrowing the terminology of Definition 6.1, we make the following definition.

Definition 6.3. Let S_π be an $(n-1)$ -dimensional cell of $Gr_{k+1,n}^+$ such that the moment map μ is an injection on S_π . Then we say its image $\mu(S_\pi)$ in $\Delta_{k+1,n}$ is a *generalized triangle* in $\Delta_{k+1,n}$.

We have already studied the generalized triangles in $\Delta_{k+1,n}$ in Proposition 3.15: they come from $(n-1)$ -dimensional positroid cells whose matroid is connected, or equivalently, they come from the positroid cells whose reduced plabic graphs are trees. And since these are positroid cells in $Gr_{k+1,n}^+$, each such plabic graph, when drawn as a trivalent graph, is a tree with n leaves with precisely k internal black vertices.

The next result shows that generalized triangles in $\Delta_{k+1,n}$ correspond to the weak generalized triangles in $\mathcal{A}_{n,k,2}$ which were studied in [LPSV19]. Therefore the latter objects precisely come from cells of the form $S_{\hat{\pi}}$, where π is an $(n-1)$ -dimensional positroid cell of $Gr_{k+1,n}^+$ whose matroid is connected.

Proposition 6.4. *There is a bijective map between generalized triangles in $\Delta_{k+1,n}$ and collections of k non-intersecting triangles in an n -gon. Moreover this map sends the cell S_π of $Gr_{k+1,n}^+$ to the cell $S_{\hat{\pi}}$ of $Gr_{k,n}^+$.*

Proof. We construct this map explicitly: take a label for a generalized triangle $S_\pi \subset Gr_{k+1,n}^+$, i.e. a collection of nonintersecting polygons inside an n -gon: $\mathcal{P} = (P_1, \dots, P_r)$. Consider the complement of this collection, thought of as a subset of the n -gon. It is again a collection of nonintersecting polygons sharing at most a vertex and we denote it by $\overline{\mathcal{P}} = (\overline{P}_1, \dots, \overline{P}_{\bar{r}})$. In the next step, choose a triangulation of all polygons into triangles $\mathcal{P} \rightarrow \mathcal{T} = (T_1, \dots, T_k)$ and $\overline{\mathcal{P}} \rightarrow \overline{\mathcal{T}} = (\overline{T}_1, \dots, \overline{T}_{n-k-2})$. Associate a black vertex to the middle of each triangle T and a white vertex with to middle of each triangle \overline{T} . Finally, connect each pair of vertices corresponding to triangles sharing an edge and draw an edge through each boundary of the n -gon. This way we get a tree graph with exactly k black and $n-k-2$ white vertices. It is a plabic graph for the corresponding cell $S_{\hat{\pi}} \subset Gr_{k,n}^+$. This construction does not provide a unique plabic graph for a given generalized triangle because there is a choice of triangulations of collections \mathcal{P} and $\overline{\mathcal{P}}$ which leads to different plabic graphs. All of them are however related to each other by flips and therefore correspond to the same cell in $Gr_{k+1,n}^+$. The map in the opposite direction can also be easily constructed. \square

In Proposition 6.6, we will show that the weak generalized triangles from [LPSV19] are in fact generalized triangles.

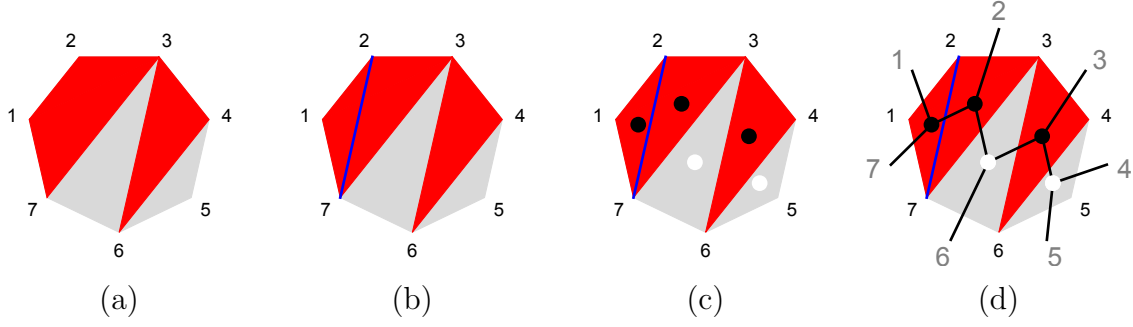

FIGURE 4. The map in Proposition 6.4 for $\pi = \{4, 7, 1, 6, \underline{5}, 3, 2\} \in G_{3,7}^+$:
 (a) Generalized triangle label, (b) A triangulation of collections \mathcal{P} and $\bar{\mathcal{P}}$,
 (c) Assigning vertices, (d) Plabic diagram of $\tilde{\pi} = \{7, 1, 6, 5, 3, 2, 4\} \in G_{4,7}^+$

We've seen now that T-duality relates generalized triangles in the hypersimplex and the amplituhedron. In the following we show that T-duality also relates triangulations and dissections of the hypersimplex and amplituhedron.

Theorem 6.5. *The T-duality map provides a bijection between the triangulations of the hypersimplex $\Delta_{k+1,n}$ constructed in Theorem 4.3, and the triangulations of the amplituhedron $\mathcal{A}_{n,k,2}$ constructed in Theorem 4.9. More specifically, let $\{S_\pi\}$ be a collection of cells of $Gr_{k+1,n}^+$ constructed from Theorem 4.3. Then this collection gives a triangulation of $\Delta_{k+1,n}$ if and only if the collection $\{S_{\tilde{\pi}}\}$ of cells of $Gr_{k,n}^+$ gives a triangulation of $\mathcal{A}_{n,k,2}$.*

The same statement holds if we replace the word “triangulation” everywhere with “dissection.”

Proof. We prove this by induction on $k + n$, using Theorem 4.3 and Theorem 4.9. It suffices to show:

- if $\{S_\pi\}_{\pi \in \mathcal{C}}$ dissects $\Delta_{k+1,n-1}$ and $\{S_{\tilde{\pi}}\}_{\tilde{\pi} \in \hat{\mathcal{C}}}$ dissects $\mathcal{A}_{n-1,k,2}$ then for any $\pi \in \mathcal{C}$, $\widehat{\mathbf{i}}_{\text{pre}}(\pi) = \iota_{\text{pre}}(\hat{\pi})$.
- if $\{S_\pi\}_{\pi \in \mathcal{C}}$ dissects $\Delta_{k,n-1}$ and $\{S_{\tilde{\pi}}\}_{\tilde{\pi} \in \hat{\mathcal{C}}}$ dissects $\mathcal{A}_{n-1,k-1,2}$ then for any $\pi \in \mathcal{C}$, $\widehat{\mathbf{i}}_{\text{inc}}(\pi) = \iota_{\text{inc}}(\hat{\pi})$.

Let $\pi = (a_1, \dots, a_{n-1})$ be a decorated permutation. We first verify the first statement. Then $\mathbf{i}_{\text{pre}}(\pi) = (a_1, a_2, \dots, a_{n-2}, n, a_{n-1})$, so $\widehat{\mathbf{i}}_{\text{pre}}(\pi) = (a_{n-1}, a_1, a_2, \dots, a_{n-2}, n)$, where n is a black fixed point. Meanwhile, $\hat{\pi} = (a_{n-1}, a_1, a_2, \dots, a_{n-2})$, so $\iota_{\text{pre}}(\hat{\pi}) = (a_{n-1}, a_1, a_2, \dots, a_{n-2}, n)$, where n is a black fixed point.

We now verify the second statement. Let $j = \pi^{-1}(n-1)$. Then we have that $\mathbf{i}_{\text{inc}}(\pi) = (a_1, a_2, \dots, a_{j-1}, n, a_{j+1}, \dots, a_{n-1}, n-1)$, and $\widehat{\mathbf{i}}_{\text{inc}}(\pi) = (n-1, a_1, a_2, \dots, a_{j-1}, n, a_{j+1}, \dots, a_{n-1})$. Meanwhile $\hat{\pi} = (a_{n-1}, a_1, a_2, \dots, a_{n-2})$. Then it is straightforward to verify that $\iota_{\text{inc}}(\hat{\pi})$ is exactly the permutation $\widehat{\mathbf{i}}_{\text{inc}}(\pi) = (n-1, a_1, a_2, \dots, a_{j-1}, n, a_{j+1}, \dots, a_{n-1})$, as desired. \square

Proposition 6.6. *Suppose that $S_\pi \subset Gr_{k+1,n}^+$ is an $(n-1)$ -dimensional cell on which the moment map μ is injective. Then $S_{\tilde{\pi}} \subset Gr_{k,n}^+$ is a $2k$ -dimensional cell on which the \tilde{Z} -map is injective; in particular, $S_{\tilde{\pi}}$ is a generalized triangle.*

Proof. By Proposition 3.15, the fact that μ is injective implies that a (any) reduced plabic graph G representing S_π must be a (planar) tree. But then by Theorem 4.3 (see Figure 1), G has a black or white vertex which is incident to two adjacent boundary vertices i and $i+1$ (modulo n), and hence appears in some triangulation of the hypersimplex (and specifically on the right-hand side of Figure 1).

Applying Theorem 6.5, we see that $\hat{\pi}$ appears in some triangulation of the amplituhedron $\mathcal{A}_{n,k,2}$. It follows that \tilde{Z} is injective on $S_{\hat{\pi}}$. \square

Using Proposition 6.6, Proposition 3.12 and Proposition 3.14, we obtain the following.

Corollary 6.7. *The \tilde{Z} -map is an injection on all $2k$ -dimensional cells of the form $S_{\hat{\pi}} \subset Gr_{k,n}^+$, where π is a SIF permutation and $\dim S_\pi = n - 1$.*

We know from Proposition 3.14 that the moment map is an injection on the cell S_π of $Gr_{k,n}^+$ precisely when $\dim S_\pi = n - c$, where c is the number of connected components of the positroid of π . We have experimentally checked the following statement for these cells.

Conjecture 6.8. *Let S_π corresponds to a loopless $(n - c)$ -dimensional cell of $Gr_{k+1,n}^+$ with c connected components (for c a positive integer). Then $S_{\hat{\pi}}$ is a coloopless $(2k + 1 - c)$ -dimensional cell of $Gr_{k,n}^+$ on which \tilde{Z} is injective. Moreover, all codimension-one boundaries of generalised triangles arise this way.*

Note that the statement that $S_{\hat{\pi}}$ is coloopless of dimension $(2k+1-c)$ follows from Lemma 5.2 and Proposition 5.17. Moreover the $c = 1$ case of the conjecture is Proposition 6.6.

While Theorem 6.5 shows that T-duality relates a large class of triangulations/dissections of $\Delta_{k+1,n}$ to a corresponding large class of triangulations/dissections of $\mathcal{A}_{n,k,2}$, not all triangulations/dissections arise from the recurrences used there. Nevertheless, we conjecture the following.

Conjecture 6.9. *Let $\{S_\pi\}$ be a collection of cells of $Gr_{k+1,n}^+$. Then this collection gives a triangulation (respectively, dissection) of $\Delta_{k+1,n}$ if and only if the collection $\{S_{\hat{\pi}}\}$ of cells of $Gr_{k,n}^+$ gives a triangulation (respectively, dissection) of $\mathcal{A}_{n,k,2}$.*

This conjecture is supported by the results of Section 7 (which relates parity duality and T-duality), and will be explored in a subsequent work. We have also checked the conjecture using Mathematica, see Section 10.

7. T-DUALITY, CYCLIC SYMMETRY AND PARITY DUALITY

In this section we discuss the relation of T-duality to *parity duality*, which relates dissections of the amplituhedron $\mathcal{A}_{n,k,m}$ with dissections of $\mathcal{A}_{n,n-m-k,m}$. The definition of parity duality was originally inspired by the physical operation of parity conjugation in quantum field theory – more specifically, in the context of scattering amplitudes in $\mathcal{N} = 4$ Super-Yang-Mills, where amplitudes can be computed from the geometry of $\mathcal{A}_{n,k,4}$ [AHT14]. Furthermore, the conjectural formula of Karp, Williams, and Zhang [KWZ] for the number of cells in each triangulation of the amplituhedron is invariant under the operation of swapping the parameters k and $n - m - k$ and hence is consistent with parity duality: this motivated further works [FLP19, GL].

In Theorem 7.3, we will explain how parity duality for $m = 2$ amplituhedra is naturally induced by a composition of the usual duality for Grassmannians ($Gr_{k,n} \simeq Gr_{n-k,n}$) and the T-duality map (between loopless cells of $Gr_{k+1,n}^+$ and coloopless cells of $Gr_{k,n}^+$). The usual Grassmannian duality gives rise to a bijection between dissections of the hypersimplex $\Delta_{k+1,n}$ and dissections of the hypersimplex $\Delta_{n-k-1,n}$. By composing this Grassmannian duality with the T-duality map (on both sides), we obtain the parity duality between dissections of $\mathcal{A}_{n,k,2}$ and $\mathcal{A}_{n,n-k-2,2}$, respectively. This makes the rather complicated notion of parity duality at $m = 2$ quite transparent!

Recall that our convention on dissections is that the images of all positroid cells are of full dimension $n - 1$. Therefore all positroids involved in a dissection must be connected, and the corresponding decorated permutations will be fixed-point-free.

Theorem 7.1 (Grassmannian duality for dissections of the hypersimplex). *Let $\{S_\pi\}$ be a collection of cells in $Gr_{k+1,n}^+$ which dissects the hypersimplex $\Delta_{k+1,n}$. Then the collection of cells $\{S_{\pi^{-1}}\}$ in $Gr_{n-k-1,n}^+$ dissects the hypersimplex $\Delta_{n-k-1,n}$.*

Proof. If G is a plabic graph representing the positroid cell S_π , and if we swap the colors of the black and white vertices of G , we obtain a graph G' representing the positroid $S_{\pi^{-1}}$. It is not hard to see from [ARW16] that G' and π^{-1} represent the *dual positroid* to G and π . But now the matroid polytopes Γ_π and $\Gamma_{\pi^{-1}}$ are isomorphic via the map $\text{dual} : \mathbb{R}^n \rightarrow \mathbb{R}^n$ sending $(x_1, \dots, x_n) \mapsto (1 - x_1, \dots, 1 - x_n)$. This maps relates the two dissections in the statement of the theorem. \square

By composing the inverse map on decorated permutations $\pi \mapsto \pi^{-1}$ (which represents the Grassmannian duality of Theorem 7.1) with T-duality, we obtain the following map.

Definition 7.2. We define $\widetilde{U}_{k,n}$ to be the map between coloopless permutations on $[n]$ with k anti-excedances and coloopless permutations on $[n]$ with $n - k - 2$ anti-excedances such that $\widetilde{U}_{k,n}\hat{\pi} = \widehat{\pi^{-1}}$. Equivalently, we have $(\widetilde{U}_{k,n}\pi)(i) = \pi^{-1}(i - 1) - 1$, where values of the permutation are considered modulo n , and any fixed points which are created are designated to be loops.

Theorem 7.3 (Parity duality from T-duality and Grassmannian duality). *Let $\{S_\pi\}$ be a collection of cells in $Gr_{k,n}^+$ which dissects the amplituhedron $\mathcal{A}_{n,k,2}$. Then the collection of cells $\{S_{\widetilde{U}_{k,n}\pi}\}$ in $Gr_{n-k-2,n}^+$ dissects the amplituhedron $\mathcal{A}_{n,n-k-2,2}$.*

We will prove Theorem 7.3 by using the cyclic symmetry of the positive Grassmannian and the amplituhedron, and showing (see Lemma 7.8) that up to a cyclic shift, our map $\widetilde{U}_{k,n}$ agrees with the parity duality map of [GL].

The totally nonnegative Grassmannian exhibits a beautiful *cyclic symmetry* [Pos]. Let us represent an element of $Gr_{k,n}^+$ by a $k \times n$ matrix, encoded by the sequence of n columns $\langle v_1, \dots, v_n \rangle$. We define the (*left*) *cyclic shift map* σ to be the map which sends $\langle v_1, \dots, v_n \rangle$ to the point $\langle v_2, \dots, v_n, (-1)^{k-1}v_1 \rangle$, which one can easily verify lies in $Gr_{k,n}^+$. Since the cyclic shift maps positroid cells to positroid cells, for π a decorated permutation, we define $\sigma\pi$ to be the decorated permutation such that $S_{\sigma\pi} = \sigma(S_\pi)$. It is easy to see that $\sigma\pi(i) = \pi(i + 1) - 1$.

(Note that under the cyclic shift, a fixed point of π at position $i + 1$ gets sent to a fixed point of $\sigma\pi$ at position i ; we color fixed points accordingly.) Meanwhile the inverse operation, the *right cyclic shift* σ^{-1} satisfies $(\sigma^{-1}\pi)(i) = \pi(i - 1) + 1$. We use σ^t (respectively, σ^{-t}) to denote the repeated application of σ (resp. σ^{-1}) t times, so that $(\sigma^t\pi)(i) := \pi(i + t) - t$ and $(\sigma^{-t}\pi)(i) := \pi(i - t) + t$.

The next result follows easily from the definitions.

Theorem 7.4 (Cyclic symmetry for dissections of the hypersimplex). *Let $\{S_\pi\}$ be a collection of cells in $Gr_{k+1,n}^+$ which dissects the hypersimplex $\Delta_{k+1,n}$. Then the collection of cells $\{S_{\sigma\pi}\}$ in $Gr_{k+1,n}^+$ dissects $\Delta_{k+1,n}$.*

Proof. Let $\sigma_{\mathbb{R}} : \mathbb{R}^n \rightarrow \mathbb{R}^n$ be defined by $(x_1, \dots, x_n) \mapsto (x_2, \dots, x_n, x_1)$. Clearly $\sigma_{\mathbb{R}}$ is an isomorphism mapping the hypersimplex $\Delta_{k+1,n}$ back to itself. Moreover, applying the cyclic shift σ to a positroid has the effect of simply shifting all its bases, so the matroid polytope of $\sigma\pi$ satisfies $\Gamma_{\sigma\pi} = \sigma_{\mathbb{R}}(\Gamma_\pi)$. The result now follows. \square

The above cyclic symmetry for dissections of the hypersimplex also has an analogue for the amplituhedron.

Theorem 7.5 (Cyclic symmetry for dissections of the amplituhedron). [BH, Corollary 3.2] *Let $\{S_\pi\}$ be a collection of cells in $Gr_{k,n}^+$ which dissects the amplituhedron $\mathcal{A}_{n,k,m}$, with m even. Then the collection of cells $\{S_{\sigma\pi}\}$ in $Gr_{k,n}^+$ also dissects $\mathcal{A}_{n,k,m}$.*

In order to make contact with [GL], we introduce a map $U_{k,n}$ on (coloopless) decorated permutations as follows.

Definition 7.6. We define $U_{k,n}$ to be the map from coloopless permutations on $[n]$ with k anti-excedances to coloopless permutations on $[n]$ with $n - k - 2$ anti-excedances such that $(U_{k,n}\pi)(i) = \pi^{-1}(i + k) + (n - k - 2)$, where values of the permutation are considered modulo n , and any fixed points which are created are designated to be loops.

It is not hard to see that this map is equivalent to the parity duality from [GL] for $m = 2$. In particular we have the following theorem:

Theorem 7.7. [GL, Theorem 7.2] *Let $\{S_\pi\}$ be a collection of cells in $Gr_{k,n}^+$ which dissects the amplituhedron $\mathcal{A}_{n,k,2}$. Then the collection of cells $\{S_{U_{k,n}\pi}\}$ in $Gr_{n-k-2,n}^+$ dissects the amplituhedron $\mathcal{A}_{n,n-k-2,2}$.*

Lemma 7.8. *For fixed n and k , the maps $\widetilde{U}_{k,n}$ and $U_{k,n}$ are related by the cyclic shift map*

$$(7.9) \quad \widetilde{U}_{k,n} = \sigma^{-(k+1)} \circ U_{k,n}.$$

Proof. Since $(U_{k,n}\pi)(i) = \pi^{-1}(i + k) + (n - k - 2)$, we have that $(\sigma^{-(k+1)} \circ U_{k,n}\pi)(i) = \pi^{-1}((i + k) - (k + 1)) + (n - k - 2) + (k + 1) = \pi^{-1}(i - 1) + n - 1$, which is exactly $\widetilde{U}_{k,n} \pmod{n}$. \square

We now prove Theorem 7.3.

Proof. This result follows immediately from Theorem 7.5, Theorem 7.7, and Lemma 7.8. \square

Remark 7.10. From Theorem 7.4 and Theorem 7.5 it is clear that if we redefine the T-duality map in Definition 5.1 by composing it with any cyclic shift σ^a (for a an integer), the main properties of the map will be preserved. In particular, any statement about dissections of the hypersimplex versus the corresponding ones of the amplituhedron will continue to hold, along with the parity duality.

Remark 7.11. Parity duality has a nice graphical interpretation when we represent generalised triangles of $\mathcal{A}_{n,k,2}$ as collection of k non-intersecting triangles in an n -gon. The Grassmannian duality of $Gr_{k+1,n}^+$ amounts to swapping black and white vertices in the plabic graphs, and when we compose it with the T-duality map, by Proposition 6.4, results in taking the complementary polygons inside the n -gon. We end up with a collection of $n - k - 2$ non-intersecting triangles in the n -gon.

8. GOOD AND BAD DISSECTIONS OF THE HYPERSIMPLEX AND THE AMPLITUHEDRON

Among all possible positroidal dissections, there are some with particularly nice features, which we will call “good”, as well as others with rather unpleasant properties. We show below examples of both a good and a bad dissection.

Example 8.1. Let us study the following triangulation of $\mathcal{A}_{6,2,2}$:

$$\mathcal{C}_1 = \{S_{\pi(1)}, S_{\pi(2)}, S_{\pi(3)}, S_{\pi(4)}, S_{\pi(5)}, S_{\pi(6)}, \}$$

with

$$\begin{aligned} \pi^{(1)} &= (\underline{1}, \underline{2}, 5, 6, 3, 4), & \pi^{(2)} &= (\underline{1}, 3, 6, 5, 2, 4), & \pi^{(3)} &= (\underline{1}, 4, 6, 2, \underline{5}, 3), \\ \pi^{(4)} &= (2, 6, \underline{3}, 5, 1, 4), & \pi^{(5)} &= (2, 6, 4, 1, \underline{5}, 3), & \pi^{(6)} &= (3, 6, 1, 4, \underline{5}, 2). \end{aligned}$$

All elements of \mathcal{C}_1 are generalized triangles and their images through \tilde{Z} -map are 4-dimensional. The triangulation \mathcal{C}_1 is a refinement of the following dissection

$$\mathcal{C}_2 = \{S_{\pi(1)}, S_{\pi(7)}, S_{\pi(8)}, S_{\pi(6)}\}$$

with

$$\pi^{(7)} = (1, 4, 6, 5, 2, 3), \quad \pi^{(8)} = (2, 6, 4, 5, 1, 3).$$

The dissection \mathcal{C}_2 has the property that if a pair of cell images under \tilde{Z} -map intersect along a 3-dimensional surface then this surface is an image of another positroid cell in $Gr_{2,6}^+$:

$$\begin{aligned} Z_{\pi(1)} \cap Z_{\pi(7)} &= Z_{(\underline{1}, \underline{2}, 6, 5, 3, 4)} \\ Z_{\pi(7)} \cap Z_{\pi(8)} &= Z_{(\underline{1}, 6, 4, 5, 2, 3)} \\ Z_{\pi(8)} \cap Z_{\pi(6)} &= Z_{(2, 6, 1, \underline{4}, \underline{5}, 3)} \end{aligned}$$

and all remaining pairs of images intersect along lower dimensional surfaces. We consider the dissection \mathcal{C}_2 “good” because all its elements have compatible codimension one boundaries. However, the dissection \mathcal{C}_1 does not have this property. Let us observe that

$$\begin{aligned} Z_{\pi(2)} \cup Z_{\pi(3)} &= Z_{\pi(7)} \\ Z_{\pi(4)} \cup Z_{\pi(5)} &= Z_{\pi(8)} \end{aligned}$$

We expect that, after we subdivide $Z_{\pi(\tau)}$ and $Z_{\pi(s)}$, the boundary $Z_{(\underline{1},6,4,5,2,3)}$ which they share will also get subdivided. This however happens in two different ways and we do not get compatible codimension one faces for the dissection \mathcal{C}_1 . It is a similar picture to the one we get when we consider polyhedral subdivisions of a double square pyramid: it is possible to subdivide it into two pieces along its equator, and then further subdivide each pyramid into two simplices. However, in order to get a polyhedral triangulation of the double square pyramid, we need to do it in a compatible way, along the same diagonal of the equatorial square. \diamond

Therefore, we prefer to work with dissections where the boundaries of the strata interact nicely. Towards this end, we introduce the following notion of *good dissection*.

Definition 8.2. Let $\mathcal{C} = \{S_{\pi(1)}, \dots, S_{\pi(\ell)}\}$ be a collection of cells of $Gr_{k+1,n}^+$. We say that \mathcal{C} induces a *good dissection* of $\Delta_{k+1,n}$ if:

- $\dim \Gamma_{\pi(i)}^\circ = n - 1$ for all i .
- $\Gamma_{\pi(i)}^\circ \cap \Gamma_{\pi(j)}^\circ = \emptyset$ for $i \neq j$.
- $\Delta_{k+1,n} = \bigcup_{i=1}^{\ell} \Gamma_{\pi(i)}$.
- For $i \neq j$, if $\Gamma_{\pi(i)} \cap \Gamma_{\pi(j)}$ has codimension one, then $\Gamma_{\pi(i)} \cap \Gamma_{\pi(j)}$ equals Γ_π , where S_π lies in the closure of both $S_{\pi(i)}$ and $S_{\pi(j)}$.

Analogously, we define good dissections of amplituhedron.

Definition 8.3. Let $\mathcal{C} = \{S_{\pi(1)}, \dots, S_{\pi(\ell)}\}$ be a collection of cells of $Gr_{k,n}^+$. We say that \mathcal{C} induces a *good dissection* of $\mathcal{A}_{n,k,m}$ if:

- $\dim Z_{\pi(i)}^\circ = mk$ for all i .
- $Z_{\pi(i)}^\circ \cap Z_{\pi(j)}^\circ = \emptyset$ for $i \neq j$.
- $\mathcal{A}_{n,k,m} = \bigcup_{i=1}^{\ell} Z_{\pi(i)}$.
- For $i \neq j$, if $Z_{\pi(i)} \cap Z_{\pi(j)}$ has codimension one, then $Z_{\pi(i)} \cap Z_{\pi(j)}$ equals Z_π , where S_π lies in the closure of both $S_{\pi(i)}$ and $S_{\pi(j)}$.

In the following, we will conjecture that good dissections of the hypersimplex are in one-to-one correspondence with good dissections of the amplituhedron. Towards this goal, we start by providing a characterization of good intersections of positroid polytopes.

Proposition 8.4. *Let $\Gamma_{\pi(1)}$ and $\Gamma_{\pi(2)}$ be two $(n - 1)$ -dimensional positroid polytopes whose intersection $\Gamma_{\pi(1)} \cap \Gamma_{\pi(2)}$ is a polytope of dimension $n - 2$. Then $\Gamma_{\pi(1)} \cap \Gamma_{\pi(2)}$ is a positroid polytope of the form $\Gamma_{\pi(3)}$, where $\pi^{(3)}$ is a loopless permutation.*

Proof. By Theorem 3.6, $\Gamma_{\pi(1)} \cap \Gamma_{\pi(2)}$ is a positroid polytope and hence has the form $\Gamma_{\pi(3)}$, for some decorated permutation $\pi^{(3)}$. (Using Proposition 3.4, the fact that $\dim(\Gamma_{\pi(3)}) = n - 2$ implies that the positroid associated to $\pi^{(3)}$ has precisely two connected components.)

Now we claim that the positroid associated to $\pi^{(3)}$ is loopless. In general there is an easy geometric way of recognizing when a matroid M is loopless from the polytope Γ_M : M is loopless if and only if Γ_M is not contained in any of the n facets of the hypersimplex of the type $x_i = 0$ for $1 \leq i \leq n$. Since $\Gamma_{\pi(3)}$ arises as the codimension 1 intersection of two full-dimensional matroid polytopes contained in $\Delta_{k+1,n}$ it necessarily meets the interior of the hypersimplex and hence the matroid must be loopless. \square

Remark 8.5. Recall that the T-duality map is well-defined on positroid cells whose matroid is connected, and more generally, loopless. Proposition 8.4 implies that if we consider two cells $S_{\pi(1)}$ and $S_{\pi(2)}$ of $Gr_{k+1,n}^+$ whose matroid is connected and whose moment map images (necessarily top-dimensional) intersect in a common facet, then that facet is the moment map image of a loopless cell $S_{\pi(3)}$. Therefore we can apply the T-duality map to all three cells $S_{\pi(1)}$, $S_{\pi(2)}$, and $S_{\pi(3)}$.

Conjecture 8.6. *Let $S_{\pi(1)}$ and $S_{\pi(2)}$ be two positroid cells in $Gr_{k,n}^+$ corresponding to coloopless permutations $\pi^{(1)}$ and $\pi^{(2)}$. Let $\dim Z_{\pi(1)}^\circ = \dim Z_{\pi(2)}^\circ = 2k$ with $Z_{\pi(1)} \cap Z_{\pi(2)} = Z_{\pi(3)}$, where $S_{\pi(3)} \subset Gr_{k,n}^+$ is such that $\dim Z_{\pi(3)}^\circ = 2k - 1$. Then $\pi^{(3)}$ is a coloopless permutation.*

Remark 8.7. Conjecture 8.6 guarantees that if we consider two positroid cells with top-dimensional images in the amplituhedron $\mathcal{A}_{n,k,2}$, which have a facet in common, then the positroid cell corresponding to this facet is coloopless and therefore we can apply the T-duality map to it.

Finally we arrive at a conjecture connecting good dissections of hypersimplex and amplituhedron, which we confirmed experimentally.

Conjecture 8.8. *Let $\{S_\pi\}$ be a collection of cells of $Gr_{k+1,n}^+$. Then this collection gives a good triangulation (respectively, good dissection) of $\Delta_{k+1,n}$ if and only if the collection $\{S_{\tilde{\pi}}\}$ of cells of $Gr_{k,n}^+$ gives a good triangulation (respectively, good dissection) of $\mathcal{A}_{n,k,2}$.*

9. THE POSITIVE TROPICAL GRASSMANNIAN AND POSITROIDAL SUBDIVISIONS

The goal of this section is to use the positive tropical Grassmannian to understand the regular positroidal subdivisions of the hypersimplex. In Section 10, we will apply the T-duality map to these regular positroidal subdivisions of the hypersimplex, to obtain subdivisions of the amplituhedron which have very nice properties.

The *tropical Grassmannian* – or rather, an outer approximation of it called the *Dressian* – controls the regular matroidal subdivisions of the hypersimplex [Kap93], [Spe08, Proposition 2.2]. There is a positive subset of the tropical Grassmannian, called the *positive tropical Grassmannian*, which was introduced by Speyer and the third author in [SW05]. The positive tropical Grassmannian equals the positive Dressian, and as we will show in Theorem 9.12, it controls the regular *positroidal* subdivisions of the hypersimplex.

Remark 9.1. We've learned since circulating the first draft of this paper that some of our results in this section regarding positroidal subdivisions of the hypersimplex and the positive tropical Grassmannian, though not previously in the literature, were known or anticipated by various other experts including David Speyer, Nima Arkani-Hamed, Thomas Lam, Marcus Spradlin, Nick Early, Felipe Rincon, Jorge Olarte. There is some related work in [Ear19] and the upcoming [AHLsSa].

9.1. The tropical Grassmannian, the Dressian, and their positive analogues.

Definition 9.2. Given $e = (e_1, \dots, e_N) \in \mathbb{Z}_{\geq 0}^N$, we let \mathbf{x}^e denote $x_1^{e_1} \dots x_N^{e_N}$. Let $E \subset \mathbb{Z}_{\geq 0}^N$. For $f = \sum_{e \in E} f_e \mathbf{x}^e$ a nonzero polynomial, we denote by $\text{Trop}(f) \subset \mathbb{R}^N$ the set of all points (X_1, \dots, X_N) such that, if we form the collection of numbers $\sum_{i=1}^N e_i X_i$ for e ranging over E , then the minimum of this collection is not unique. We say that $\text{Trop}(f)$ is the *tropical hypersurface associated to f* .

In our examples, we always consider polynomials f with real coefficients. We also have a positive version of Definition 9.2.

Definition 9.3. Let $E = E^+ \sqcup E^- \subset \mathbb{Z}_{\geq 0}^N$, and let f be a nonzero polynomial with real coefficients which we write as $f = \sum_{e \in E^+} f_e \mathbf{x}^e - \sum_{e \in E^-} f_e \mathbf{x}^e$, where all of the coefficients f_e are nonnegative real numbers. We denote by $\text{Trop}^+(f) \subset \mathbb{R}^N$ the set of all points (X_1, \dots, X_N) such that, if we form the collection of numbers $\sum_{i=1}^N e_i X_i$ for e ranging over E , then the minimum of this collection is not unique and furthermore is achieved for some $e \in E^+$ and some $e \in E^-$. We say that $\text{Trop}^+(f)$ is the *positive part of $\text{Trop}(f)$* .

The Grassmannian $Gr_{k,n}$ is a projective variety which can be embedded in projective space $\mathbb{P}^{\binom{n}{k}-1}$, and is cut out by the *Plücker ideal*, that is, the ideal of relations satisfied by the Plücker coordinates of a generic $k \times n$ matrix. These relations include the *three-term Plücker relations* defined below.

Definition 9.4. Let $1 < a < b < c < d \leq n$ and choose a subset $S \in \binom{[n]}{k-2}$ which is disjoint from $\{a, b, c, d\}$. Then $p_{Sac}p_{Sbd} = p_{Sab}p_{Scd} + p_{Sad}p_{Sbc}$ is a *three-term Plücker relations* for the Grassmannian $Gr_{k,n}$. Here Sac denotes $S \cup \{a, c\}$, etc.

Definition 9.5. Given S, a, b, c, d as in Definition 9.4, we say that the *tropical three-term Plücker relation holds* if

- $P_{Sac} + P_{Sbd} = P_{Sab} + P_{Scd} \leq P_{Sad} + P_{Sbc}$ or
- $P_{Sac} + P_{Sbd} = P_{Sad} + P_{Sbc} \leq P_{Sab} + P_{Scd}$ or
- $P_{Sab} + P_{Scd} = P_{Sad} + P_{Sbc} \leq P_{Sac} + P_{Sbd}$.

And we say that the *positive tropical three-term Plücker relation holds* if either of the first two conditions above holds.

Definition 9.6. The *tropical Grassmannian* $\text{Trop} Gr_{k,n} \subset \mathbb{R}^{\binom{[n]}{k}}$ is the intersection of the tropical hypersurfaces $\text{Trop}(f)$, where f ranges over all elements of the Plücker ideal. The *Dressian* $\text{Dr}_{k,n} \subset \mathbb{R}^{\binom{[n]}{k}}$ is the intersection of the tropical hypersurfaces $\text{Trop}(f)$, where f ranges over all three-term Plücker relations.

Similarly, the *positive tropical Grassmannian* $\text{Trop}^+ Gr_{k,n} \subset \mathbb{R}^{\binom{[n]}{k}}$ is the intersection of the positive tropical hypersurfaces $\text{Trop}^+(f)$, where f ranges over all elements of the Plücker ideal. The *positive Dressian* $\text{Dr}_{k,n}^+ \subset \mathbb{R}^{\binom{[n]}{k}}$ is the intersection of the positive tropical hypersurfaces $\text{Trop}^+(f)$, where f ranges over all three-term Plücker relations.

Note that the Dressian $Dr_{k,n}$ (respectively, the positive Dressian $Dr_{k,n}^+$) is the subset of $\mathbb{R}^{\binom{[n]}{k}}$ where the tropical (respectively, positive tropical) three-term Plücker relations hold.

In general, the Dressian $Dr_{k,n}$ is much larger than the tropical Grassmannian $\text{Trop } Gr_{k,n}$ – for example, the dimension of the Dressian $Dr_{3,n}$ grows quadratically in n , while the dimension of the tropical Grassmannian $\text{Trop } Gr_{3,n}$ is linear in n [HJJS08]. However, the situation for their positive parts is different.

Theorem 9.7. [SW]. *The positive tropical Grassmannian $\text{Trop}^+ Gr_{k,n}$ equals the positive Dressian $Dr_{k,n}^+$.*

Definition 9.8. We say that a point $\{P_I\}_{I \in \binom{[n]}{k}} \in \mathbb{R}^{\binom{[n]}{k}}$ is a (*finite*) *tropical Plücker vector* if it lies in the Dressian $Dr_{k,n}$, i.e. for every three-term Plücker relation, it lies in the associated tropical hypersurface. And we say that $\{P_I\}_{I \in \binom{[n]}{k}}$ is a *positive tropical Plücker vector*, if it lies in the positive Dressian $Dr_{k,n}^+$ (equivalently, the positive tropical Grassmannian $\text{Trop}^+ Gr_{k,n}$), i.e. for every three-term Plücker relation, it lies in the positive part of the associated tropical hypersurface.

Example 9.9. For $Gr_{2,4}$, there is only one Plücker relation, $p_{13}p_{24} = p_{12}p_{34} + p_{14}p_{23}$. The Dressian $Dr_{2,4} \subset \mathbb{R}^{\binom{[4]}{2}}$ is defined to be the set of points $(P_{12}, P_{13}, P_{14}, P_{23}, P_{24}, P_{34}) \in \mathbb{R}^6$ such that

- $P_{13} + P_{24} = P_{12} + P_{34} \leq P_{14} + P_{23}$ or
- $P_{13} + P_{24} = P_{14} + P_{23} \leq P_{12} + P_{34}$ or
- $P_{12} + P_{34} = P_{14} + P_{23} \leq P_{13} + P_{24}$.

And $Dr_{2,4}^+ = \text{Trop}^+ Gr_{2,4} \subset \mathbb{R}^{\binom{[4]}{2}}$ is defined to be the set of points $(P_{12}, P_{13}, P_{14}, P_{23}, P_{24}, P_{34}) \in \mathbb{R}^6$ such that

- $P_{13} + P_{24} = P_{12} + P_{34} \leq P_{14} + P_{23}$ or
- $P_{13} + P_{24} = P_{14} + P_{23} \leq P_{12} + P_{34}$

◇

9.2. The positive tropical Grassmannian and positroidal subdivisions. Recall that $\Delta_{k,n}$ denotes the (k, n) -hypersimplex, defined as the convex hull of the points e_I where I runs over $\binom{[n]}{k}$. Consider a real-valued function $\{I\} \mapsto P_I$ on the vertices of $\Delta_{k,n}$. We define a polyhedral subdivision \mathcal{D}_P of $\Delta_{k,n}$ as follows: consider the points $(e_I, P_I) \in \Delta_{k,n} \times \mathbb{R}$ and take their convex hull. Take the lower faces (those whose outwards normal vector have last component negative) and project them back down to $\Delta_{k,n}$; this gives us the subdivision \mathcal{D}_P . We will omit the subscript P when it is clear from context. A subdivision obtained in this manner is called *regular*.

Remark 9.10. A lower face F of the regular subdivision defined above is determined by some vector $\lambda = (\lambda_1, \dots, \lambda_n, -1)$ whose dot product with the vertices of the F is maximized. So if F is the matroid polytope of a matroid M with bases \mathcal{B} , this is equivalent to saying that $\lambda_{i_1} + \dots + \lambda_{i_k} - P_I = \lambda_{j_1} + \dots + \lambda_{j_k} - P_J > \lambda_{h_1} + \dots + \lambda_{h_k} - P_H$ for any two bases $I, J \in \mathcal{B}$ and $H \notin \mathcal{B}$.

Given a subpolytope Γ of $\Delta_{k,n}$, we say that Γ is *matroidal* if the vertices of Γ , considered as elements of $\binom{[n]}{k}$, are the bases of a matroid M , i.e. $\Gamma = \Gamma_M$.

The following result is originally due to Kapranov [Kap93]; it was also proved in [Spe08, Proposition 2.2].

Theorem 9.11. *The following are equivalent.*

- *The collection $\{P_I\}_{I \in \binom{[n]}{k}}$ is a tropical Plücker vector.*
- *The one-skeleta of \mathcal{D}_P and $\Delta_{k,n}$ are the same.*
- *Every face of \mathcal{D}_P is matroidal.*

Given a subpolytope Γ of $\Delta_{k,n}$, we say that Γ is *positroidal* if the vertices of Γ , considered as elements of $\binom{[n]}{k}$, are the bases of a positroid M , i.e. $\Gamma = \Gamma_M$. We now give a positroidal version of Theorem 9.11.

Theorem 9.12. *The following are equivalent.*

- *The collection $\{P_I\}_{I \in \binom{[n]}{k}}$ is a positive tropical Plücker vector.*
- *Every face of \mathcal{D}_P is positroidal.*

Proof. Suppose that the collection $\{P_I\}_{I \in \binom{[n]}{k}}$ are positive tropical Plücker coordinates. Then in particular they are tropical Plücker coordinates, and so by Theorem 9.11, every face of \mathcal{D}_P is matroidal.

Suppose that one of those faces Γ_M fails to be positroidal. Then by Theorem 3.8, Γ_M (and hence \mathcal{D}_P) has a two-dimensional face with vertices $e_{Sab}, e_{Sad}, e_{Sbc}, e_{Scd}$, for some $1 \leq a < b < c < d \leq n$ and S of size $k-2$ disjoint from $\{a, b, c, d\}$. By Remark 9.10, this means that there is a vector $\lambda = (\lambda_1, \dots, \lambda_n, -1)$ whose dot product is maximized at the face F . In particular, if we compare the value of the dot product at vertices of F versus e_{Sac} and e_{Sbd} , we get $\lambda_a + \lambda_b - P_{Sab} = \lambda_c + \lambda_d - P_{Scd} = \lambda_a + \lambda_d - P_{Sad} = \lambda_b + \lambda_c - P_{Sbc}$ is greater than either $\lambda_a + \lambda_c - P_{Sac}$ or $\lambda_b + \lambda_d - P_{Sbd}$. But then

$$\lambda_a + \lambda_b - P_{Sab} + \lambda_c + \lambda_d - P_{Scd} = \lambda_a + \lambda_d - P_{Sad} + \lambda_b + \lambda_c - P_{Sbc} > \lambda_a + \lambda_c - P_{Sac} + \lambda_b + \lambda_d - P_{Sbd},$$

which implies that

$$P_{Sab} + P_{Scd} = P_{Sad} + P_{Sbc} < P_{Sac} + P_{Sbd},$$

which contradicts the fact that $\{P_I\}$ is a collection of positive tropical Plücker coordinates.

Suppose that every face of \mathcal{D}_P is positroidal. Then every face is in particular matroidal, and so by Theorem 9.11, the collection $\{P_I\}_{I \in \binom{[n]}{k}}$ are tropical Plücker coordinates. Suppose that they fail to be positive tropical Plücker coordinates. Then there is some $S \in \binom{[n]}{k-2}$ and $a < b < c < d$ disjoint from S such that $P_{Sab} + P_{Scd} = P_{Sad} + P_{Sbc} < P_{Sac} + P_{Sbd}$. We will obtain a contradiction by showing that \mathcal{D}_P has a two-dimensional (non-positroidal) face with vertices $e_{Sab}, e_{Sad}, e_{Sbc}, e_{Scd}$, for some $1 \leq a < b < c < d \leq n$ and S of size $k-2$ disjoint from $\{a, b, c, d\}$.

To show that these vertices form a face, choose some large number N which is greater than the absolute value of any of the tropical Plücker coordinates, i.e. $N > \max\{|P_I|\}_{I \in \binom{[n]}{k}}$.

We define a vector $\lambda \in \mathbb{R}^n$ by setting

$$\lambda_i = \begin{cases} P_{Sab} + P_{Sac} + P_{Sad} & \text{for } i=a \\ P_{Sab} + P_{Sbc} + P_{Sbd} & \text{for } i=b \\ P_{Sac} + P_{Sbc} + P_{Scd} & \text{for } i=c \\ P_{Sad} + P_{Sbd} + P_{Scd} & \text{for } i=d \\ 3N & \text{for } i \in S \\ -3N & \text{for } i \notin S \cup \{a, b, c, d\} \end{cases}$$

Then the vertices of $\Delta_{k,n}$ maximizing the dot product with λ will certainly be some subset of $e_{Sab}, e_{Sac}, e_{Sad}, e_{Sbc}, e_{Sbd}, e_{Scd}$. And in fact the relation $P_{Sab} + P_{Scd} = P_{Sad} + P_{Sbc} < P_{Sac} + P_{Sbd}$ implies that the vertices maximizing the dot product will be exactly $e_{Sab}, e_{Sad}, e_{Sbc}, e_{Scd}$. \square

It follows from Theorem 9.12 that the regular subdivisions of $\Delta_{k+1,n}$ consisting of positroid polytopes are precisely those of the form \mathcal{D}_P , where $P = \{P_I\}$ is a positive tropical Plücker vector. This motivates the following definition.

Definition 9.13. We say that a positroidal dissection of $\Delta_{k+1,n}$ is a *regular positroidal subdivision* if it has the form \mathcal{D}_P , where $P = \{P_I\} \in \mathbb{R}^{\binom{[n]}{k}}$ is a positive tropical Plücker vector.

Remark 9.14. Every regular subdivision of a polytope is a polytopal subdivision, and so in particular it is a good dissection (see Definition 8.2).

9.3. Fan structures on the Dressian and positive Dressian. As described in [HJJS08], there are two natural fan structures on the (positive) Dressian: the *Plücker fan*, and the *secondary fan*.

We say that two elements of the Dressian, i.e. two tropical Plücker vectors $\{P_I\}_{I \in \binom{[n]}{k}}$ and $\{P'_I\}_{I \in \binom{[n]}{k}} \in \mathbb{R}^{\binom{[n]}{k}}$, lie in the same cone of the *Plücker fan* if for each S, a, b, c, d as in Definition 9.5, the same inequality holds for both $\{P_{Sac}, P_{Sbd}, P_{Sab}, P_{Scd}, P_{Sad}, P_{Sbc}\}$ and $\{P'_{Sac}, P'_{Sbd}, P'_{Sab}, P'_{Scd}, P'_{Sad}, P'_{Sbc}\}$. In particular, the maximal cones in the Plücker fan structure are the cones where the inequalities from Definition 9.5 are all strict.

On the other hand, using Theorem 9.11 and Theorem 9.12, we say that two elements of the Dressian, i.e. two tropical Plücker vectors $\{P_I\}_{I \in \binom{[n]}{k}}$ and $\{P'_I\}_{I \in \binom{[n]}{k}} \in \mathbb{R}^{\binom{[n]}{k}}$, lie in the same cone of the *secondary fan* if the matroidal subdivisions \mathcal{D}_P and $\mathcal{D}_{P'}$ coincide. In particular, the maximal cones in the secondary fan structure are the cones corresponding to the unrefinable positroidal subdivisions.

In [HJJS08] it was shown that for the Dressian $Dr_{3,n}$, the Plücker fan structure and the secondary fan structure coincide. And in [OPS19, Theorem 14] it was shown that the fan structures coincide for general Dressians $Dr_{k,n}$. We can now just refer to the fan structure on $Dr_{k,n}^+ = \text{Trop}^+ Gr_{k,n}$ without specifying either “Plücker fan” or “secondary fan.”

We have the following result.

Corollary 9.15. *A collection $\mathcal{C} = \{S_\pi\}$ of positroid cells of $Gr_{k,n}^+$ gives a regular positroidal triangulation of $\Delta_{k,n}$ (see Definition 2.5) if and only if this triangulation has the form \mathcal{D}_P , for $P = \{P_I\}_{I \in \binom{[n]}{k}}$ a positive tropical Plücker vector from a maximal cone of $\text{Trop}^+ Gr_{k,n}$.*

Proof. Suppose that a collection $\{S_\pi\}$ of positroid cells of $Gr_{k,n}^+$ is a regular positroidal triangulation; in other words, the images of the cells $\{S_\pi\}$ under the moment map are the top-dimensional positroid polytopes in the subdivision \mathcal{D}_P of $\Delta_{k,n}$, and the moment map is an injection on each S_π . Therefore by Proposition 3.14 and Proposition 3.15, $\dim S_\pi = n - 1$, each positroid M_π is connected, and the reduced plabic graph associated to π is a (planar) tree.

We claim that the collection $\{S_\pi\}$ gives an unrefineable possible positroidal subdivision of the hypersimplex. That is, there is no nontrivial way to subdivide one of the positroid polytopes Γ_π into two full dimensional positroid polytopes. If we *can* subdivide Γ_π as above, and there is another full-dimensional positroid polytope $\Gamma_{\pi'}$ strictly contained in Γ_π , then the bases of $M_{\pi'}$ are a subset of the bases of Γ_π , and hence the cell $S_{\pi'}$ lies in the closure of S_π . But then a reduced plabic graph G' for $S_{\pi'}$ can be obtained by deleting some edges from a reduced plabic graph G for S_π ; this means that G' has fewer faces than G and hence has the corresponding cell has smaller dimension, which is a contradiction, so the claim is true.

But now the fact that $\{S_\pi\}$ gives an unrefineable positroidal subdivision means that it came from a maximal cone of $\text{Trop}^+ Gr_{k,n}$.

Conversely, consider a regular positroidal subdivision \mathcal{D}_P coming from a maximal cone of $\text{Trop}^+ Gr_{k,n}$. Then the subdivision \mathcal{D}_P (which we identify with its top-dimensional pieces $\{S_\pi\}$) is an unrefineable positroidal subdivision. In other words, none of the positroid polytopes Γ_π can be subdivided into two full-dimensional positroid polytopes, which in turn means that the reduced plabic graph corresponding to π must be a tree. This implies that the moment map is an injection on each S_π and hence $\{S_\pi\}$ gives a regular positroidal triangulation of $\Delta_{k,n}$. \square

Corollary 9.16. *The number of regular positroidal triangulations of the hypersimplex $\Delta_{k,n}$ equals the number of maximal cones in the positive tropical Grassmannian $\text{Trop}^+ Gr_{k,n}$.*

The fact that the Plücker fan structure and the secondary fan structure on $\text{Trop}^+ Gr_{k,n}$ coincide also implies that the f -vector of $\text{Trop}^+ Gr_{k,n}$ reflects the number of positroidal subdivisions of $\Delta_{k,n}$ (with maximal cones corresponding to unrefineable subdivisions and rays corresponding to coarsest subdivisions).

10. REGULAR POSITROIDAL SUBDIVISIONS OF $\Delta_{k+1,n}$ AND $\mathcal{A}_{n,k,2}$ FROM $\text{Trop}^+ Gr_{k+1,n}$

In Section 8, we discussed the fact that arbitrary dissections of the hypersimplex and the amplituhedron can have rather unpleasant properties, with their maximal cells intersecting badly at their boundaries. We introduced the notion of *good dissections* for the hypersimplex and amplituhedron in Definition 8.2 and Definition 8.3. Our goal in this section is to introduce a large class of good dissections for the amplituhedron – these are the *regular positroidal subdivisions*.

10.1. Regular positroidal subdivisions of $\mathcal{A}_{n,k,2}$. Recall from Definition 9.13 that the *regular positroidal subdivisions* of $\Delta_{k+1,n}$ are precisely the dissections of the form \mathcal{D}_P (see Section 9.2) where $P = \{P_I\} \in \mathbb{R}^{\binom{[n]}{k}}$. We know from Section 5, Section 6, and Section 7 that T-duality maps dissections of $\Delta_{k+1,n}$ to the amplituhedron $\mathcal{A}_{n,k,2}$ and preserves various nice properties along the way. We therefore use the T-duality map from Definition 5.1 to define *regular (positroidal) subdivisions* of the $m = 2$ amplituhedron $\mathcal{A}_{n,k,2}$.

Definition 10.1. We say that a positroidal dissection of $\mathcal{A}_{n,k,2}$ is a *regular positroidal subdivision* if it has the form $\{S_{\hat{\pi}}\}$, where $\{S_{\pi}\}$ is a regular positroidal subdivision of $\Delta_{k+1,n}$.

As every regular positroidal subdivision of $\Delta_{k+1,n}$ is a polyhedral subdivision (and hence is good), Conjecture 8.8 implies the following.

Conjecture 10.2. *Every regular positroidal subdivision of $\mathcal{A}_{n,k,2}$ is a good dissection.*

In Section 11.3 we provide some computational evidence for Conjecture 10.2. For example, for $\mathcal{A}_{6,2,2}$ and $\mathcal{A}_{7,2,2}$, every regular positroidal subdivision is good, and moreover, all good dissections are regular positroidal subdivisions. (This appears to also be the case for $\mathcal{A}_{8,2,2}$; but we were only able to compute the number of *triangulations* in this case.) One might hope to strengthen Conjecture 10.2 and conjecture that the regular positroidal subdivisions are precisely the good dissections. However, the notion of regularity is rather subtle (as usual in polyhedral geometry), and starting from $\mathcal{A}_{9,2,2}$, there are some good dissections which are not regular.

10.2. The fan structure for regular positroidal subdivisions. We now discuss the fan structure for regular positroidal subdivisions of the hypersimplex and amplituhedron.

Definition 10.3. Given two subdivisions $\{\Gamma_{\pi}\}$ and $\{\Gamma_{\pi'}\}$ of $\Delta_{k+1,n}$, we say that $\{\Gamma_{\pi}\}$ *refines* $\{\Gamma_{\pi'}\}$ and write $\{\Gamma_{\pi}\} \preceq \{\Gamma_{\pi'}\}$ if every Γ_{π} is contained in some $\Gamma_{\pi'}$.

Similarly, given two subdivisions $\{Z_{\pi}\}$ and $\{Z_{\pi'}\}$ of $\mathcal{A}_{n,k,2}$, we say that $\{Z_{\pi}\}$ *refines* $\{Z_{\pi'}\}$ and write $\{Z_{\pi}\} \preceq \{Z_{\pi'}\}$ if every Z_{π} is contained in some $Z_{\pi'}$.

Recall from Section 9.3 that we have a fan structure on $\text{Trop}^+ Gr_{k+1,n}$ (the *secondary fan*, which coincides with the *Plücker fan*) which describes the regular positroidal subdivisions of $\Delta_{k+1,n}$, ordered by refinement. We expect that this fan structure on $\text{Trop}^+ Gr_{k+1,n}$ also describes the regular positroidal subdivisions of $\mathcal{A}_{n,k,2}$.

Conjecture 10.4. *The regular positroidal subdivisions of $\mathcal{A}_{n,k,2}$ are parametrized by the cones of $\text{Trop}^+ Gr_{k+1,n}$, with the natural partial order on the cones reflecting the refinement order on positroidal subdivisions.*

Conjecture 10.4 is consistent with the following conjecture.

Conjecture 10.5. *Consider two regular positroidal subdivisions $\{\Gamma_{\pi}\}$ and $\{\Gamma_{\pi'}\}$ of $\Delta_{k+1,n}$, and two corresponding positroidal subdivisions $\{Z_{\hat{\pi}}\}$ and $\{Z_{\hat{\pi}'}\}$ of $\mathcal{A}_{n,k,2}$. Then we have that $\{\Gamma_{\pi}\} \preceq \{\Gamma_{\pi'}\}$ if and only if $\{Z_{\hat{\pi}}\} \preceq \{Z_{\hat{\pi}'}\}$*

In particular, the regular positroidal triangulations of $\mathcal{A}_{n,k,2}$ should come precisely from the maximal cones of $\text{Trop}^+ Gr_{k+1,n}$. More specifically, if $\{P_I\}$ lies in a maximal cone of

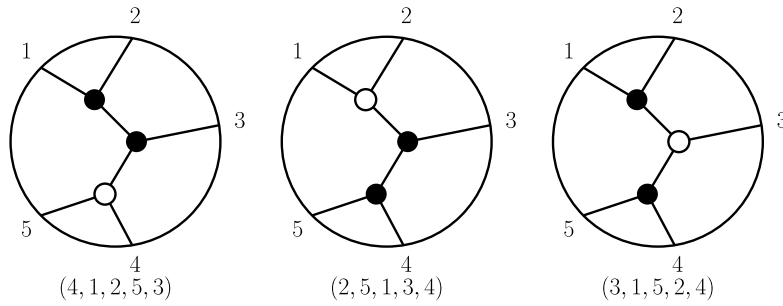

FIGURE 5. The collection $\mathcal{T}_{5,2}$ of plabic graphs giving a regular subdivision of $\Delta_{3,5}$

$\text{Trop}^+ Gr_{k+1,n}$, and $\{S_\pi\}$ is the regular positroidal triangulation corresponding to \mathcal{D}_P , then $\{S_{\hat{\pi}}\}$ should be a regular positroidal triangulation of $\mathcal{A}_{n,k,2}$. (Moreover, all regular positroidal triangulations of $\mathcal{A}_{n,k,2}$ should arise in this way.)

10.3. A large class of regular positroidal triangulations of $\Delta_{k+1,n}$ and $\mathcal{A}_{n,k,2}$.

Definition 10.6. Let T be any planar trivalent tree with n leaves (which will necessarily have $n - 2$ internal vertices), embedded in a disk with the leaves labelled from 1 to n in clockwise order. Let $\mathcal{T}_{n,k}$ be the set of $\binom{n-2}{k}$ plabic graphs obtained from T by colouring precisely k of the internal vertices black, as in Section 10.3.

Proposition 10.7. *The cells of $Gr_{k+1,n}^+$ corresponding to the plabic graphs in $\mathcal{T}_{n,k}$ give a regular triangulation of $\Delta_{k+1,n}$. Therefore the images of these cells under the T -duality map give a regular triangulation of $\mathcal{A}_{n,k,2}$.*

Proof. We can use Theorem 4.3 (see Figure 1) to inductively prove that the cells corresponding to $\mathcal{T}_{n,k}$ give a triangulation of $\Delta_{k+1,n}$. The fact that the cells corresponding to the plabic graphs in $\mathcal{T}_{n,k}$ give a *regular* triangulation of $\Delta_{k+1,n}$ follows from [Spe08, Theorem 8.4]. Now using Theorem 6.5, it follows that the images of these cells under the T -duality map give a triangulation of $\mathcal{A}_{n,k,2}$. The fact that this triangulation is regular now follows from Definition 10.1. \square

Remark 10.8. The above construction gives us C_{n-2} regular triangulations of $\mathcal{A}_{n,k,2}$, where $C_n = \frac{1}{n+1} \binom{2n}{n}$ is the Catalan number.

10.4. The f -vector of $\text{Trop}^+ Gr_{k+1,n}$. In light of Conjecture 10.4, it is useful to compute the f -vector of the positive tropical Grassmannian. This is the vector (f_0, f_1, \dots, f_d) whose components compute the number of cones of fixed dimension.

As shown in [SW05], the positive tropical Grassmannian has an n -dimensional lineality space coming from the torus action. However, one may mod out by this torus action and study the resulting fan. The method used in [SW05] was to show that $\text{Trop}^+ Gr_{k,n}$ (a polyhedral subcomplex of $\mathbb{R}^{\binom{n}{k}}$) is combinatorially equivalent to an $(n - k - 1)(k - 1)$ -dimensional fan $F_{k,n}$, obtained by using an “ X -cluster” or “web” parametrization of the

positive Grassmannian, and modding out by the torus action. As explained in [SW05, Section 6], $F_{k,n}$ is the dual fan to the Minkowski sum of the $\binom{n}{k}$ Newton polytopes obtained by writing down each Plücker coordinate in the X -cluster parametrization.

Using this technique, [SW05] computed the f -vector of $\text{Trop}^+ Gr_{2,n}$ (which is the f -vector of the associahedron, with maximal cones corresponding to triangulations of a polygon) $\text{Trop}^+ Gr_{3,6}$, and $\text{Trop}^+ Gr_{3,7}$. The above f -vector computations were recently extended in [AHLsb] using the notion of “stringy canonical forms” and in [BC, CGUZ] using planar arrays and matrices of Feynman diagrams. See also [HP, DFGK, Ear] for recent, physics-inspired developments in this direction. We list all known results about maximal cones in the positive tropical Grassmannian $\text{Trop}^+ Gr_{k+1,n}$ and their relation to triangulations of hypersimplex $\Delta_{k+1,n}$ in Table 1.

Apart from the f -vector of $\text{Trop}^+ Gr_{2,n}$, the known f -vectors of positive tropical Grassmannians $\text{Trop}^+ Gr_{k,n}$ (with $k \leq \frac{n}{2}$) are the following:

$$\text{Trop}^+ Gr_{3,6} : (1, 48, 98, 66, 16, 1)$$

$$\text{Trop}^+ Gr_{3,7} : (1, 693, 2163, 2583, 1463, 392, 42, 1)$$

$$\text{Trop}^+ Gr_{3,8} : (1, 13612, 57768, 100852, 93104, 48544, 14088, 2072, 120, 1)$$

$$\text{Trop}^+ Gr_{4,8} : (1, 90608, 444930, 922314, 1047200, 706042, 285948, 66740, 7984, 360, 1)$$

For $\text{Trop}^+ Gr_{4,9}$ it is also known that the second component of the f -vector is 30659424 [CGUZ].

In Section 11, we will describe our computational data concerning the numbers of good dissections of the amplituhedron $\mathcal{A}_{n,k,2}$. We will reproduce some of the data from the above list of f -vectors, giving evidence for Conjecture 10.4.

Remark 10.9. The coordinate ring of the Grassmannian has the structure of a *cluster algebra* [Sco06]. In particular, $Gr_{2,n}$, $Gr_{3,6}$, $Gr_{3,7}$, $Gr_{3,8}$ have cluster structures of finite types A_n , D_4 , E_6 , and E_8 , respectively. As discussed in [SW05], there is an intriguing connection between $\text{Trop}^+ Gr_{k,n}$ and the cluster structure. In particular, $F_{2,n}$ is the fan to the type A_n associahedron, while $F_{3,6}$ and $F_{3,7}$ are refinements of the fans associated to the D_4 and E_6 associahedra. Via our correspondence between $\text{Trop}^+ Gr_{k+1,n}$ and the amplituhedron $\mathcal{A}_{n,k,2}$, the Grassmannian cluster structure on $Gr_{k+1,n}$ should be reflected in good subdivisions of $\mathcal{A}_{n,k,2}$. In particular the type A_n cluster structure should control $\mathcal{A}_{n,1,2}$ (this is apparent, since $\mathcal{A}_{n,1,2}$ is a projective polygon), while the type D_4 , E_6 , and E_8 cluster structures should be closely related to $\mathcal{A}_{6,2,2}$, $\mathcal{A}_{7,2,2}$, and $\mathcal{A}_{8,2,2}$.

11. MATHEMATICA EXPERIMENTS

Many statements from this paper can be checked directly for small values of n and k using Mathematica. In particular, facts about positroid cells: finding loopless and coloopless permutations, defining the T-duality map, etc., can be implemented using the ‘positroid’ package by Jacob Bourjaily [Bou]. In order to find weak generalized triangles and be able to talk about their boundaries in the amplituhedron/hypersimplex space, one needs to be able to find the dimension of the image of a given positroid cell through the \tilde{Z} -map, the

$\Phi_{(\tilde{\Lambda}, \Lambda)}$ -map and the moment map μ . An implementation of these functions, and many more functions related to boundary structures of amplituhedron, momentum amplituhedron and hypersimplex can be found in the package ‘`amplituhedronBoundaries`’ [LM].

11.1. Dissections and triangulations. Let us focus here on the amplituhedron $\mathcal{A}_{n,k,2}$: an analogous construction can be implemented also for the momentum amplituhedron and the hypersimplex. In order to find all triangulations of the amplituhedron (Definition 2.9), one starts from a single triangulation, e.g. a BCFW triangulation, and repeatedly applies flips to generate new triangulations. The flips can be generated by triangulating $(2k+1)$ -dimensional positroid cells S_π of $Gr_{k,n}^+$ for which $\tilde{Z}(S_\pi)$ is $2k$ -dimensional. For $k=1$ we get all possible usual bi-stellar flips for polygons: each of them corresponds to two different ways of triangulating a square. For higher k , there are other types of flips, which in general involves more than 4 generalized triangles; however, in all cases they always preserve the number of positroid cells in a triangulation. Once we have the set of all possible flips, we apply them to the starting triangulation and produce a new set of triangulations. Iterating the same procedure to this new set, we can start filling in the space of all possible triangulations. The algorithm stops when no new new triangulations are found in this way. Assuming that the graph of triangulations is connected (w.r.t. flips defined above), we obtain all triangulations of the amplituhedron after a finite number of steps.

It is easy to apply this procedure for $k=1$: we find that the number of all possible triangulations of $\mathcal{A}_{n,1,2}$ is C_{n-2} , where C_p is the p -th Catalan number. This is expected since $\mathcal{A}_{n,1,2}$ is just a convex n -gon. For $k=2$, we found that the number of triangulations for $\mathcal{A}_{5,2,2}$ is 5: this comes from the fact that $\mathcal{A}_{5,1,2}$ is parity dual to $\mathcal{A}_{5,1,2}$, by Theorem 7.7. The first non-trivial example is $\mathcal{A}_{6,2,2}$, for which we find 120 triangulations (this agrees with the number found in [GL, Example 13.15]). We were also able to find that the number of triangulations for $\mathcal{A}_{7,2,2}$ is 3073 and for $\mathcal{A}_{8,2,2}$ is 6443460. Beyond these examples, and their parity conjugates, the number of triangulations was beyond reach of our computational power (even if we can easily generate a significant number of them).

By knowing all triangulations, one can find dissections by merging together generalized triangles present in a given triangulation into larger images under the \tilde{Z} -map. For $k=1$, as expected, the number of all dissections of $\mathcal{A}_{n,1,2}$ agrees with the little Schroeder numbers (elements of the sequence A001003 in [S⁺]). For the non-trivial $k=2$ cases: we found 517 dissections⁵ for $n=6$ and 82503 dissections for $n=7$.

11.2. Good dissections and triangulations. In order to find good triangulations (resp. dissections) we can select among all triangulations (resp. dissections) the ones satisfying the conditions in Definition 8.3. This allowed us to find the complete poset of good dissections of $\mathcal{A}_{6,2,2}$ and $\mathcal{A}_{7,2,2}$. In particular, their f -vectors read:

$$\begin{aligned} \mathcal{A}_{6,2,2} &: (1, 48, 98, 66, 16, 1) \\ \mathcal{A}_{7,2,2} &: (1, 693, 2163, 2583, 1463, 392, 42, 1) \end{aligned}$$

which, as observed in Section 10, are exactly the f -vectors of the positive tropical Grassmannian $\text{Trop}^+ Gr_{3,6}$ and $\text{Trop}^+ Gr_{3,7}$, respectively.

⁵This number differs from the one in [GL].

If we are only interested in triangulations, then there exists another way to find all good triangulations by considering the *adjacency graph* of generalised triangles. We define two generalized triangles to be *adjacent* if they are disjoint and satisfy the last condition in Definition 8.3. After generating this adjacency graph, we use the `IGCliques` function from the `IGraph` package [Hor19] to find all maximal cliques, which conjecturally correspond to good triangulations. This allowed us to find the number of good triangulations for $k = 2$ and $k = 3$:

n	4	5	6	7	8	9
Good triangulations of $\mathcal{A}_{n,2,2}$	1	5	48	693	13612	346806
Good triangulations of $\mathcal{A}_{n,3,2}$	-	1	14	693	91496	?

11.3. Regular triangulations and subdivisions. We observed that the f-vectors for good dissections of $\mathcal{A}_{6,2,2}$ and $\mathcal{A}_{7,2,2}$ do agree with the ones in the positive tropical Grassmannian. Moreover, for $\mathcal{A}_{8,2,2}$, we were able to check that the number of good triangulations agrees with the number of maximal cones in $\text{Trop}^+ Gr_{3,8}$. Starting from $n = 9$, the number of good triangulations is larger than the number of maximal cones in positive tropical Grassmannian. It is indeed the first example where one can find good triangulations which are not regular. In particular, out of 346806 good triangulations (see table above), 96 are not regular. Similarly, for $k = 3$ and $n = 8$, 888 good triangulations of $\mathcal{A}_{8,3,2}$ are not regular. These correspond exactly to degenerate matrices found in [CGUZ].

We summarize all our finding for triangulations in Table 1. We also included there the results for $Gr_{3,9}^+$ which, by using our conjectures, can be extracted from [CGUZ].

(k, n)	Triangulations	Good triangs	$\text{Trop}^+ Gr_{k+1,n}$	Non-regular good triangs
$(1, n)$	C_{n-2}	C_{n-2}	C_{n-2}	0
$(2, 5)$	5	5	5	0
$(2, 6)$	120	48	48	0
$(2, 7)$	3073	693	693	0
$(2, 8)$	6 443 460	13 612	13 612	0
$(2, 9)$?	346 806	346 710	96
$(3, 6)$	14	14	14	0
$(3, 7)$	3073	693	693	0
$(3, 8)$?	91 496	90 608	888
$(3, 9)$?	33 182 763	30 659 424	2 523 339

TABLE 1. New results about the triangulations of the amplituhedron $\mathcal{A}_{n,k,2}$ in relation to known results about the number of maximal cones of the positive tropical Grassmannian $\text{Trop}^+ Gr_{k+1,n}$.

12. T-DUALITY AND THE MOMENTUM AMPLITUHEDRON FOR GENERAL (EVEN) M

Throughout the paper we have explored the remarkable connection between the hyper-simplex and the $m = 2$ amplituhedron. This was established via the T-duality map which

allowed to relate generalised triangles, triangulations, and dissections of both objects. It is then a natural question to wonder whether the story generalises for any (even) m .

For $m = 4$, we know that the amplituhedron $\mathcal{A}_{n,k,4}$ encodes the geometry of scattering amplitudes in $\mathcal{N} = 4$ SYM, expressed in momentum twistor space. Physicists have already observed a beautiful connection between this and the formulation of scattering amplitudes of the same theory in momentum space⁶. At the core of this connection lies the Amplitude-Wilson Loop Duality [AR08], which was shown to arise from a more fundamental duality in String Theory called ‘T-duality’ [BM08]. For both formulations a Grassmannian representation has been found [BMS10, AHCK10]: scattering amplitudes (at tree level) are computed by performing a contour integral around specific cycles inside the positive Grassmannian (what in physics is referred to as a ‘BCFW contour’). If we are in momentum space, then one has to integrate over cycles corresponding to collections of $(2n - 4)$ -dimensional positroid cells of $Gr_{k+2,n}^+$. Whereas, if we are in momentum twistor space, the integral is over collections of $4k$ -dimensional positroid cells of $Gr_{k,n}^+$. The two integrals compute the same scattering amplitude, and it was indeed shown that that formulas are related by a change of variables. In particular, this implied the existence of a map between certain $(2n - 4)$ -dimensional positroid cells of $Gr_{k+2,n}^+$ and certain $4k$ -dimensional positroid cells of $Gr_{k,n}^+$ (called ‘BCFW’), which was defined in [AHBC⁺16, Formula (8.25)]. It is easy to see that this map is exactly our T-duality map for the case $m = 4$ in (5.13), up to a cyclic shift:

$$(12.1) \quad \sigma \hat{\pi}(i) = \pi(i - \frac{m}{2} + 1) - 1 = \pi(i - 1) - 1.$$

Collections of $4k$ -dimensional ‘BCFW’ positroid cells of $Gr_{k,n}^+$ defined from physics were conjectured to triangulate $\mathcal{A}_{n,k,4}$. The main results in the literature towards proving this conjecture can be found in [KWZ]. On the other hand, the corresponding collections of $(2n - 4)$ -dimensional ‘BCFW’ positroid cells of $Gr_{k+2,n}^+$ were conjectured to triangulate an object $\mathcal{M}_{n,k,4}$ called ‘momentum amplituhedron’, introduced recently by two of the authors in [DFLP19]⁷. Many properties of $\mathcal{M}_{n,k,4}$ have still to be explored and proven; however, there are many evidences for the following conjecture:

Conjecture 12.2. [DFLP19] *Let $\{S_\pi\}$ be a collection of cells of $Gr_{k+2,n}^+$. Then this collection gives a triangulation (respectively, dissection) of $\mathcal{M}_{n,k,4}$ if and only if the collection $\{S_{\hat{\pi}}\}$ of cells of $Gr_{k,n}^+$ gives a triangulation (respectively, dissection) of $\mathcal{A}_{n,k,4}$.*

The story starts to look familiar, and it aligns with the philosophy of the rest of this paper. In particular, one aims to seek for an object and a map which relates its ‘triangles’, triangulations (and, more generally, dissections) to the ones of $\mathcal{A}_{n,k,m}$, for general (even) m . There is a natural candidate for such a map: we have already seen that the T-duality map defined in (5.13) does indeed the job in the case of $m = 2$ and $m = 4$. Moreover, some of the statements which has been proven throughout the paper for $m = 2$, as Proposition 5.17 and Theorem 7.3, can be generalised for general (even) m .

⁶more precisely it is ‘spinor helicity’ space, or, equivalently (related by half-Fourier transform), in twistor space. See [AHBC⁺16, Section 8].

⁷In the paper, the momentum amplituhedron was denoted as $\mathcal{M}_{n,k}$, without the subscript ‘4’.

Proposition 12.3. *Let S_π be a cell of $Gr_{k+\frac{m}{2},n}^+$ such that, as affine permutation, $\pi(i) \geq i + \frac{m}{2}$. Then $S_{\hat{\pi}}$ is a cell of $Gr_{k,n}^+$ such that $\hat{\pi}(i) \leq i + a - \frac{m}{2}$. Moreover, $\dim(S_{\hat{\pi}}) - mk = \dim(S_\pi) - \frac{m}{2}(n - \frac{m}{2})$. In particular, if $\dim S_\pi = \frac{m}{2}(n - \frac{m}{2})$, then $\dim S_{\hat{\pi}} = mk$.*

Proof. The proof closely follows the one of Proposition 5.17, recalling the definition of the T-duality map for general (even) m : $\hat{\pi}(i) = \pi(i - \frac{m}{2})$. Since $\text{span}\{\hat{c}_a, \dots, \hat{c}_b\} \subset \text{span}\{c_{a-\frac{m}{2}}, \dots, c_b\}$, one can check that the rank of each chain $\hat{r}[a + \frac{m}{2}; \hat{\pi}(a + \frac{m}{2})]$ is lowered by $\frac{m}{2}$ relative to $r[a; \pi(a)]$. Performing analogous calculations one finds:

$$(12.4) \quad \dim(S_{\hat{\pi}}) - mk = \dim(S_\pi) - \frac{m}{2} \left(n - \frac{m}{2} \right).$$

□

It is also natural to think parity duality between $\mathcal{A}_{n,k,m}$ and $\mathcal{A}_{n,n-k-m,m}$ as a composition of the Grassmannian duality and T-duality (plus cyclic shifts). Imitating Definition 7.2, let us define $\tilde{U}_{k,n,m}(\hat{\pi}) := \widehat{\pi^{-1}}$. Then we have the following theorem:

Theorem 12.5 (Parity duality from T-duality and Grassmannian duality). *Let $\{S_\pi\}$ be a collection of cells in $Gr_{k,n}^+$ which dissects the amplituhedron $\mathcal{A}_{n,k,m}$. Then the collection of cells $\{S_{\tilde{U}_{k,n,m}\pi}\}$ in $Gr_{n-k-m,n}^+$ dissects the amplituhedron $\mathcal{A}_{n,n-k-m,m}$.*

Proof. The parity duality $U_{k,n,m}$ in [GL] was defined for any (even) m as: $U_{k,n,m}(\pi) := (\pi - k)^{-1} + (n - k - m)$. Then it easy to show that $U_{k,n,m} = \sigma^{k+\frac{m}{2}} \circ \tilde{U}_{k,n,m}$. Using Theorem 7.5, the prove follows immediately. □

Since we found a natural candidate map, we now introduce a natural candidate object, which would speculatively relate to $\mathcal{A}_{n,k,m}$ via the T-duality map. This is a generalisation of the momentum amplituhedron $\mathcal{M}_{n,k,4}$ and it is defined below.

Definition 12.6. For k, n such that $k \leq n$, define the *twisted positive part* of $Gr_{k,n}$ as:

$$(12.7) \quad Gr_{k,n}^{+,\tau} := \{X \in Gr_{k,n} : (-1)^{\text{inv}(I, [n] \setminus I)} \Delta_{[n] \setminus I}(X) \geq 0\}$$

where $\text{inv}(A, B) := \#\{a \in A, b \in B | a > b\}$ denotes the inversion number.

The lemma below can be found in [Kar17, Lemma 1.11], which sketched a proof and attributed it to Hochster and Hilbert.

Lemma 12.8. *Suppose $\Delta_I(V)$ are the Plücker coordinates of a point $V \in Gr_{k,n}$. Then the kernel $V^\perp \in Gr_{n-k,n}$ of V is represented by the point with Plücker coordinates $\Delta_J(V^\perp) = (-1)^{\text{inv}(J, [n] \setminus J)} \Delta_{[n] \setminus J}(V)$ for $J \in \binom{[n]}{n-k}$.*

Definition 12.9. For a, b such that $a \leq b$, define $\text{Mat}_{a,b}^{>0}$ the set of real $a \times b$ matrices whose $a \times a$ minors are all positive and its *twisted positive part* as

$$(12.10) \quad \text{Mat}_{a,b}^{>0,\tau} := \{A \in \text{Mat}_{a,b} : (-1)^{\text{inv}(I, [b] \setminus I)} \Delta_{[b] \setminus I}(A) > 0\}$$

Definition 12.11. Let $\tilde{\Lambda} \in \text{Mat}_{k+m,n}^{>0}$, $\Lambda \in \text{Mat}_{n-k,n}^{>0,\tau}$, where $m \geq 0$ is a fixed even number with $k+m \leq n$. Then the pair of matrices $(\tilde{\Lambda}, \Lambda)$ induces a map

$$(12.12) \quad \Phi_{\tilde{\Lambda}, \Lambda} : Gr_{k+\frac{m}{2},n}^+ \rightarrow Gr_{k+\frac{m}{2},k+m} \times Gr_{n-k-\frac{m}{2},n-k}$$

defined by

$$(12.13) \quad \Phi_{\tilde{\Lambda}, \Lambda}(\langle v_1, \dots, v_{k+\frac{m}{2}} \rangle) := \left(\langle \tilde{\Lambda}(v_1), \dots, \tilde{\Lambda}(v_{k+\frac{m}{2}}) \rangle, \langle \Lambda(v_1^\perp), \dots, \Lambda(v_{n-k-\frac{m}{2}}^\perp) \rangle \right)$$

where $\langle v_1, \dots, v_{k+\frac{m}{2}} \rangle$ is an element of $Gr_{k+\frac{m}{2},n}^+$ written as the span of $k + \frac{m}{2}$ basis vectors and $\langle v_1^\perp, \dots, v_{n-k-\frac{m}{2}}^\perp \rangle := \langle v_1, \dots, v_{k+\frac{m}{2}} \rangle^\perp$ is an element in $Gr_{n-k-\frac{m}{2},n}^{+,\tau}$ written as the span of $n - k - \frac{m}{2}$ basis vectors. The *momentum amplituhedron* $\mathcal{M}_{n,k,m}(\Lambda, \tilde{\Lambda})$ is defined to be the image $\Phi_{\tilde{\Lambda}, \Lambda}(Gr_{k+\frac{m}{2},n}^+)$ inside $Gr_{k+\frac{m}{2},k+m} \times Gr_{n-k-\frac{m}{2},n-k}$.

Remark 12.14. As for the amplituhedron $\mathcal{A}_{n,k,m}$, the combinatorial properties of $\mathcal{M}_{n,k,m}(\Lambda, \tilde{\Lambda})$ are conjectured to be independent from the actual choice of the external data Λ and $\tilde{\Lambda}$. We will then write $\mathcal{M}_{n,k,m}$ from now on. However, as observed in [DFLP19], the geometry might be “non-convex” for some choices of Λ and $\tilde{\Lambda}$.

Proposition 12.15. Let $(\tilde{Y}, Y) \in \mathcal{M}_{n,k,m}$ and let $\langle \tilde{Y}_1^\perp, \dots, \tilde{Y}_{\frac{m}{2}}^\perp \rangle := \tilde{Y}^\perp \in Gr_{\frac{m}{2},m+k}$ and $\langle Y_1^\perp, \dots, Y_{\frac{m}{2}}^\perp \rangle := Y^\perp \in Gr_{\frac{m}{2},n-k}$ be orthogonal complements of \tilde{Y} and Y , respectively. Then we have the following inclusion of subspaces in \mathbb{R}^n :

$$(12.16) \quad \langle \tilde{\Lambda}^t(\tilde{Y}_1^\perp), \dots, \tilde{\Lambda}^t(\tilde{Y}_{\frac{m}{2}}^\perp) \rangle \subseteq \langle \Lambda^t(Y_1^\perp), \dots, \Lambda^t(Y_{\frac{m}{2}}^\perp) \rangle^\perp,$$

or, equivalently,

$$(12.17) \quad \langle \Lambda^t(Y_1^\perp), \dots, \Lambda^t(Y_{\frac{m}{2}}^\perp) \rangle \subseteq \langle \tilde{\Lambda}^t(\tilde{Y}_1^\perp), \dots, \tilde{\Lambda}^t(\tilde{Y}_{\frac{m}{2}}^\perp) \rangle^\perp.$$

Proof. Since by definition $\langle Y_1^\perp, \dots, Y_{\frac{m}{2}}^\perp \rangle = \langle Y_1, \dots, Y_{n-k-\frac{m}{2}} \rangle^\perp$ and using (12.11), we have

$$(12.18) \quad 0 = Y_a^\perp \cdot Y_\alpha = Y_a^\perp \cdot \Lambda(v_\alpha^\perp) = \Lambda^t(Y_a^\perp) \cdot v_\alpha^\perp$$

for all $a \in \{1, \dots, \frac{m}{2}\}$ and $\alpha \in \{1, \dots, n-k-\frac{m}{2}\}$. This implies that the $\frac{m}{2}$ -dimensional subspace $\langle \Lambda^t(Y_1^\perp), \dots, \Lambda^t(Y_{\frac{m}{2}}^\perp) \rangle$ is included in $\langle v_1^\perp, \dots, v_{n-k-\frac{m}{2}}^\perp \rangle^\perp = \langle v_1, \dots, v_{k+\frac{m}{2}} \rangle$. Using an analogous argument for \tilde{Y} , we can conclude that the $\frac{m}{2}$ -dimensional subspace $\langle \tilde{\Lambda}^t(\tilde{Y}_1^\perp), \dots, \tilde{\Lambda}^t(\tilde{Y}_{\frac{m}{2}}^\perp) \rangle$ is included in the kernel of $\langle v_1, \dots, v_{k+\frac{m}{2}} \rangle$. Therefore the subspace $\langle v_1, \dots, v_{k+\frac{m}{2}} \rangle$ is included in the kernel of $\langle \tilde{\Lambda}^t(\tilde{Y}_1^\perp), \dots, \tilde{\Lambda}^t(\tilde{Y}_{\frac{m}{2}}^\perp) \rangle$ which proves our claim. \square

Remark 12.19. In reference to Definition 12.11, we observe that:

$$(12.20) \quad \dim \left(Gr_{k+\frac{m}{2},k+m} \times Gr_{n-k-\frac{m}{2},n-k} \right) = \frac{m}{2} \left(k + \frac{m}{2} \right) + \frac{m}{2} \left(n - k - \frac{m}{2} \right) = \frac{m}{2} n.$$

Moreover, Proposition 12.15 implies that the momentum amplituhedron $\mathcal{M}_{n,k,m}$ is included in a codimension $(\frac{m}{2})^2$ sub-variety of $Gr_{k+\frac{m}{2},k+m} \times Gr_{n-k-\frac{m}{2},n-k}$. We note that, for $m = 4$,

Eq.(12.16) corresponds to the condition of *momentum conservation*. Therefore, the dimension of $\mathcal{M}_{n,k,m}$ is at most (and conjectured to be exactly):

$$(12.21) \quad \frac{m}{2}n - \left(\frac{m}{2}\right)^2 = \frac{m}{2} \left(n - \frac{m}{2}\right).$$

We observe that, for $m = 2$, this dimension is exactly $n - 1$, which is the dimension of the hypersimplex $\Delta_{k+1,n}$; whereas, for $m = 4$, the dimension is $2n - 4$, which is the one of BCFW cells in momentum space.

Remark 12.22 ($m = 2$ case). For $m = 2$, Definition 12.11 reads:

$$(12.23) \quad \Phi_{\tilde{\Lambda},\Lambda} : Gr_{k+1,n}^+ \rightarrow Gr_{k+1,k+2} \times Gr_{n-k-1,n-k} \cong \mathbb{P}^{k+1} \times \mathbb{P}^{n-k-1}.$$

Moreover, the conditions in Proposition 12.15 are equivalent to:

$$(12.24) \quad \Lambda^t(Y_1^\perp) \cdot \tilde{\Lambda}^t(\tilde{Y}_1^\perp) = 0$$

where we used the dot product in \mathbb{R}^n .

Note that the $m = 2$ momentum amplituhedron is not equal to the hypersimplex, but these objects seem to be closely related, and have the same dissections.

Remark 12.25 ($m = 4$ case). For $m = 4$, Definition 12.11 coincides with the one in [DFLP19]. This is the positive geometry relevant for scattering amplitudes for $\mathcal{N} = 4$ SYM in spinor helicity space.

Finally, we speculate that:

Conjecture 12.26. *Let $\{S_\pi\}$ be a collection of cells of $Gr_{k+\frac{m}{2},n}^+$. Then this collection gives a triangulation (respectively, dissection) of $\mathcal{M}_{n,k,m}$ if and only if the collection $\{S_{\tilde{\pi}}\}$ of cells of $Gr_{k,n}^+$ gives a triangulation (respectively, dissection) of $\mathcal{A}_{n,k,m}$.*

13. SUMMARY AND OUTLOOK

In this paper we have discovered and explored a remarkable connection between the hypersimplex $\Delta_{k+1,n}$ (Section 2.2) and the $m = 2$ amplituhedron $\mathcal{A}_{n,k,2}$ (Definition 2.7). This connection was realised via a map we call *T-duality* (Definition 5.1). We showed that T-duality sends *generalized triangles* of the hypersimplex to generalized triangles of the amplituhedron (Proposition 6.6). Moreover, it sends triangulations (resp. dissections) of the hypersimplex to triangulations (resp. dissections) of the amplituhedron, see Theorem 6.5 and Conjecture 6.9. Providing further evidence for Conjecture 6.9, we showed in Theorem 7.3 that *parity duality* for the amplituhedron (which relates dissections of $\mathcal{A}_{n,k,2}$ with dissections of $\mathcal{A}_{n,n-k-2,2}$) is a composition of the hypersimplex duality ($\Delta_{k+1,n} \simeq \Delta_{n-k-1,n}$) with T-duality on both sides. Supported by Proposition 8.4 as well as the experimental evidence from Section 11.2, we also conjectured that T-duality gives a bijection between the *good dissections* of $\Delta_{k+1,n}$ and the good dissections of $\mathcal{A}_{n,k,2}$, see Definitions 8.2 and 8.3, and Conjecture 8.8.

Via T-duality, we showed that the *positive tropical Grassmannian* $\text{Trop}^+ Gr_{k+1,n}$ is closely connected to the amplituhedron $\mathcal{A}_{n,k,2}$ and its good dissections. To make this connection, we first gave a new characterisation of positroid polytopes in Theorem 3.8, then showed

in Theorem 9.12 that the *regular positroidal subdivisions* of $\Delta_{k+1,n}$ come precisely from the positive tropical Grassmannian $\text{Trop}^+ Gr_{k+1,n}$. Supported by Proposition 8.4, we conjectured that the images of these subdivisions under the T-duality map are good dissections of the amplituhedron $\mathcal{A}_{n,k,2}$ (Conjecture 10.2). In particular, $\text{Trop}^+ Gr_{k+1,n}$ should play the role of *secondary fan* for the regular positroidal subdivisions of $\mathcal{A}_{n,k,2}$ (Conjecture 10.4). Note that all conjectures in this paper are supported by experimental evidence (Section 11); we plan to further investigate them in a separate work.

In this paper we have also observed that a third object, the $m = 2$ *momentum amplituhedron* $\mathcal{M}_{n,k,2}$ (Remark 12.22), is closely related to the $m = 2$ amplituhedron $\mathcal{A}_{n,k,2}$ and the hypersimplex $\Delta_{k+1,n}$. All of them are images of a positive Grassmannian through particular maps, see Figure 6. While most of this paper concerns the $m = 2$ case, we believe that

$$\begin{array}{ccccc}
 Gr_{k+1,n}^+ & \xleftarrow{id} & Gr_{k+1,n}^+ & \xrightarrow{Q} & Gr_{k,n}^+ \\
 \downarrow \Phi_{\tilde{\Lambda}, \Lambda} & & \downarrow \mu & & \downarrow \tilde{Z} \\
 \mathcal{M}_{n,k,2} & & \Delta_{k+1,n} & & \mathcal{A}_{n,k,2}
 \end{array}$$

FIGURE 6

much of this story admits a generalization to arbitrary (even) m . The amplituhedron $\mathcal{A}_{n,k,m}$ was already defined for arbitrary m and we gave a corresponding general definition of the momentum amplituhedron $\mathcal{M}_{n,k,m}$ for any (even) m . We conjectured that a more general version of T-duality relates $\mathcal{A}_{n,k,m}$ and $\mathcal{M}_{n,k,m}$, see (5.13). However, it is not clear what should replace the moment map μ for $m \neq 2$ and, in particular, whether there is suitable ‘polytopal’ generalization of the hypersimplex beyond $m = 2$.

One of the exciting results of our paper is the connection we have established between the positive tropical Grassmannian $\text{Trop}^+ Gr_{k+1,n}$ and the amplituhedron $\mathcal{A}_{n,k,2}$. This leads to interesting speculations, both physical and mathematical. From the viewpoint of physics, the positive tropical Grassmannian governs (a generalisation of) the scattering amplitudes in a scalar cubic field theory called ‘biadjoint scalar’ [CEGM19], while the $m = 4$ amplituhedron plays a prominent role in a gauge theory, namely $\mathcal{N} = 4$ SYM. This prompts the question of whether there could be some physical duality between these scalar and gauge field theories. From the viewpoint of mathematics, since the positive tropical Grassmannian is closely connected to the cluster structure on the Grassmannian [SW05], this leads to the idea (see Remark 10.9) that the cluster structure on the Grassmannian $Gr_{k+1,n}$ should play a role in governing the good subdivisions of $\mathcal{A}_{n,k,2}$.

14. APPENDIX. COMBINATORICS OF CELLS OF THE POSITIVE GRASSMANNIAN.

In [Pos], Postnikov defined several families of combinatorial objects which are in bijection with cells of the positive Grassmannian, including *decorated permutations*, \mathbb{J} -*diagrams*, and equivalence classes of *reduced plabic graphs*. Here we review these objects and give bijections between them. This will give us a canonical way to label each positroid by a decorated

permutation, a \mathcal{J} -diagram, and an equivalence class of plabic graphs. Our exposition here closely follows [KWZ, Section 2].

Definition 14.1. A *decorated permutation* of $[n]$ is a bijection $\pi : [n] \rightarrow [n]$ whose fixed points are each coloured either black (loop) or white (coloop). We denote a black fixed point i by $\pi(i) = \underline{i}$, and a white fixed point i by $\pi(i) = \bar{i}$. An *anti-excedance* of the decorated permutation π is an element $i \in [n]$ such that either $\pi^{-1}(i) > i$ or $\pi(i) = \bar{i}$.

For example, $\pi = (3, \underline{2}, 5, 1, 6, 8, \bar{7}, 4)$ has a loop in position 2, and a coloop in position 7. It has three anti-excedances, in positions 4, 7, 8.

Definition 14.2. An *affine permutation* on $[n]$ is a bijection $\pi : \mathbb{Z} \rightarrow \mathbb{Z}$ such that $\pi(i+n) = \pi(i) + n$ and $i \leq \pi(i) \leq i+n$, for all $i \in \mathbb{Z}$.

By definition, it is clear that, in order to specify an affine permutation π , it is enough to give the values of the images of $[n]$, i.e. $\pi = (\pi(1), \dots, \pi(n))$. For example, $\pi = (3, 2, 5, 9, 6, 8, 15, 12)$.

Moreover, there is a one-to-one map between decorated permutations and affine permutations. Given a decorated permutation π_d we can define an affine permutation π_a by the following procedure: if $\pi_d(i) > i$, then define $\pi_a(i) := \pi_d(i)$; if $\pi_d(i) < i$, then define $\pi_a(i) := \pi_d(i) + n$; if $\pi_d(i)$ is a loop then define $\pi_a(i) := i$; if $\pi_d(i)$ is a coloop then define $\pi_a(i) := i + n$. For example, under this map, the decorated permutation $\pi_d = (3, \underline{2}, 5, 1, 6, 8, \bar{7}, 4)$ in the previous example gives rise to $\pi_a = (3, 2, 5, 9, 6, 8, 15, 12)$.

Clearly if a decorated permutation π_d has k anti-excedances, then the corresponding affine permutation π_a satisfies the extra condition: $\sum_{i=1}^n (\pi_a(i) - i) = kn$. Such affine permutations are called (k, n) -*bounded affine permutations* and are in bijection with decorated permutations on n letters with k anti-excedances. Postnikov showed that the positroids for $Gr_{k,n}^{\geq 0}$ are indexed by decorated permutations of $[n]$ with exactly k anti-excedances (equivalently, by (k, n) -bounded affine permutations) [Pos, Section 16].

Now we introduce certain fillings of Young diagrams with the symbols 0 and +, called \mathcal{J} -*diagrams*, which are in bijection with decorated permutations.

Definition 14.3. [Pos, Section 20] Fix $0 \leq k \leq n$. Given a partition λ , we let Y_λ denote the Young diagram of λ . A \mathcal{J} -*diagram of type (k, n)* is a filling D of a Young diagram Y_λ fitting inside a $k \times (n - k)$ rectangle with the symbols 0 and +, which avoids the \mathcal{J} -configuration: in other words, it has no 0 with both a + above it in the same column and a + to its left in the same row. We call λ the *shape* of D . (See Figure 7.)

We associate a decorated permutation π of $[n]$ to D as follows (see [Pos, Section 19]).

1. Replace each + in D with an elbow $\swarrow \searrow$, and each 0 in D with a cross \oplus .
2. View the southeast border of Y_λ as a lattice path of n steps from the northeast corner to the southwest corner of the $k \times (n - k)$ rectangle, and label its edges by $1, \dots, n$.
3. Label each edge of the northwest border of Y_λ with the label of its opposite edge on the southeast border. This gives a *pipe dream* P associated to D .
4. Read off the decorated permutation π from P by following the ‘pipes’ from the southeast border to the northwest border Y_λ . If the pipe originating at i ends at j , we set $\pi(i) := j$. If $\pi(i) = i$, then either i labels two horizontal edges or two

vertical edges of P . In the former case, we set $\pi(i) := \underline{i}$, and in the latter case, we set $\pi(i) := \bar{i}$.

Figure 7 illustrates this procedure. We denote the pipe dream P by $P(D)$, and the decorated permutation π by π_D . Note that the anti-excedances of π correspond to the vertical steps of the southeast border of Y_λ , so π has exactly k anti-excedances. We denote the corresponding positroid cell of $Gr_{k,n}^{\geq 0}$ (see [Pos, Section 16], and also Theorem 14.11) by S_π or S_D .

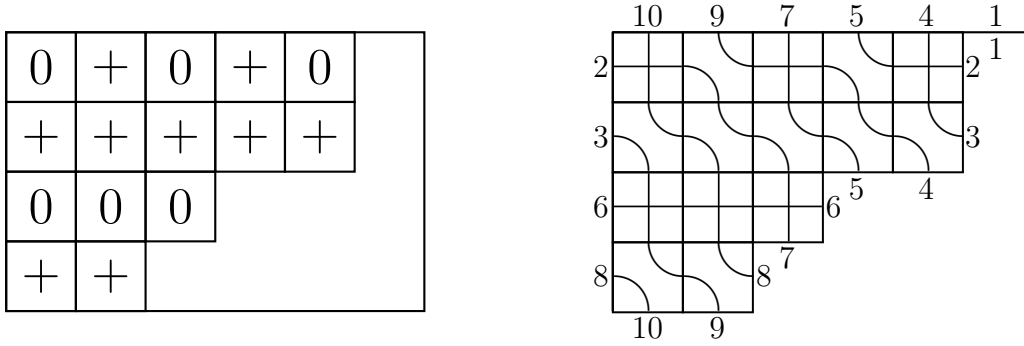

FIGURE 7. A \mathcal{J} -diagram D of type $(4, 10)$ with shape $\lambda = (5, 5, 3, 2)$, and its corresponding pipe dream P with decorated permutation $\pi_D = (\underline{1}, 5, 4, 9, 7, \bar{6}, 2, 10, 3, 8)$.

Lemma 14.4 ([Pos, Corollary 20.1 and Theorem 6.5]). *The map $D \mapsto \pi_D$ from Definition 14.3 is a bijection from the set of \mathcal{J} -diagrams of type (k, n) to the set of decorated permutations of $[n]$ with k anti-excedances. Therefore, \mathcal{J} -diagrams of type (k, n) index the cells of $Gr_{k,n}^{\geq 0}$. The dimension of the cell S_D indexed by D is the number of $+$'s in D .*

Definition 14.5. A *plabic graph*⁸ is an undirected planar graph G drawn inside a disk (considered modulo homotopy) with n boundary vertices on the boundary of the disk, labeled $1, \dots, n$ in clockwise order, as well as some *internal vertices*. Each boundary vertex is incident to a single edge, and each internal vertex is colored either black or white. If a boundary vertex is incident to a leaf (a vertex of degree 1), we refer to that leaf as a *lollipop*.

Definition 14.6. A *perfect orientation* \mathcal{O} of a plabic graph G is a choice of orientation of each of its edges such that each black internal vertex u is incident to exactly one edge directed away from u ; and each white internal vertex v is incident to exactly one edge directed towards v . A plabic graph is called *perfectly orientable* if it admits a perfect orientation. Let $G_{\mathcal{O}}$ denote the directed graph associated with a perfect orientation \mathcal{O} of G . The *source set* $I_{\mathcal{O}} \subset [n]$ of a perfect orientation \mathcal{O} is the set of i which are sources of the directed graph $G_{\mathcal{O}}$. Similarly, if $j \in \bar{I}_{\mathcal{O}} := [n] - I_{\mathcal{O}}$, then j is a sink of \mathcal{O} .

Figure 8 shows a plabic graph with a perfect orientation. In that example, $I_{\mathcal{O}} = \{2, 3, 6, 8\}$.

⁸“Plabic” stands for *planar bi-colored*.

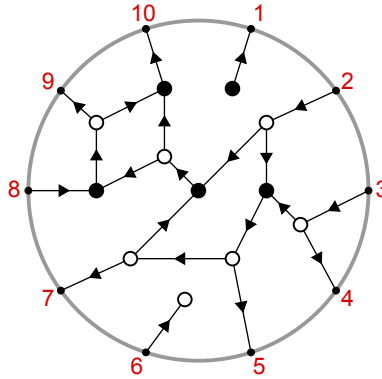

FIGURE 8. A plabic graph with a perfect orientation.

All perfect orientations of a fixed plabic graph G have source sets of the same size k , where $k - (n - k) = \sum \text{color}(v) \cdot (\deg(v) - 2)$. Here the sum is over all internal vertices v , $\text{color}(v) = 1$ for a black vertex v , and $\text{color}(v) = -1$ for a white vertex; see [Pos]. In this case we say that G is of *type* (k, n) .

As shown in [Pos, Section 11], every perfectly orientable plabic graph gives rise to a positroid as follows. (Moreover, every positroid can be realized in this way.)

Proposition 14.7. *Let G be a plabic graph of type (k, n) . Then we have a positroid M_G on $[n]$ whose bases are precisely*

$$\{I_{\mathcal{O}} \mid \mathcal{O} \text{ is a perfect orientation of } G\},$$

where $I_{\mathcal{O}}$ is the set of sources of \mathcal{O} .

We note that one can also read off the positroid from G using *flows* [Tal08], or equivalently, perfect matchings.

The following construction of Postnikov associates a hook diagram, network, and plabic graph to any \mathbb{J} -diagram.

Definition 14.8 ([Pos, Sections 6 and 20]). Let D be a \mathbb{J} -diagram of type (k, n) . We define the *hook diagram* $H(D)$ of D , the *network* $N(D)$ of D , and the *plabic graph* $G(D)$ of D . (See Figure 10 for examples.)

To construct $H(D)$, we delete the 0's of D , and replace each $+$ with a vertex. From each vertex we construct a hook which goes east and south, to the border of the Young diagram of D . We label the edges of the southeast border of D by $1, \dots, n$ from northeast to southwest.

To construct $N(D)$, we direct the edges of $H(D)$ west and south. Let E be the set of horizontal edges of $N(D)$. To each such edge $e \in E$, we associate a variable a_e .

To construct $G(D)$ from $H(D)$, we place boundary vertices $1, \dots, n$ along the southeast border. Then we replace the local region around each internal vertex as in Figure 9, and add a black (respectively, white) lollipop for each black (respectively, white) fixed point of the decorated permutation π_D .

More generally, each \mathbb{J} -diagram D is associated with a family of *reduced plabic graphs* consisting of $G(D)$ together with other plabic graphs which can be obtained from $G(D)$ by certain *moves*; see [Pos, Section 12].

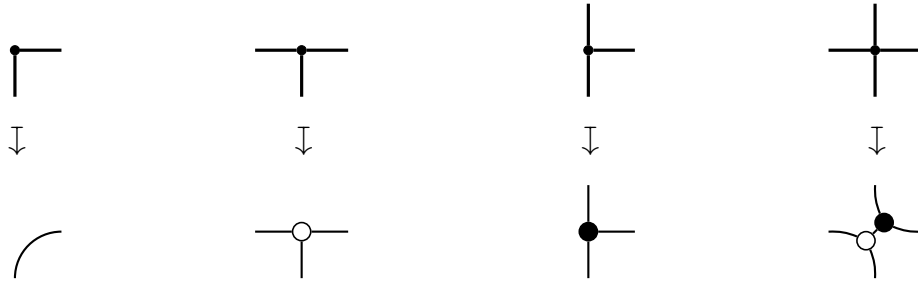

FIGURE 9. Local substitutions for going from the hook diagram $H(D)$ to the plabic graph $G(D)$.

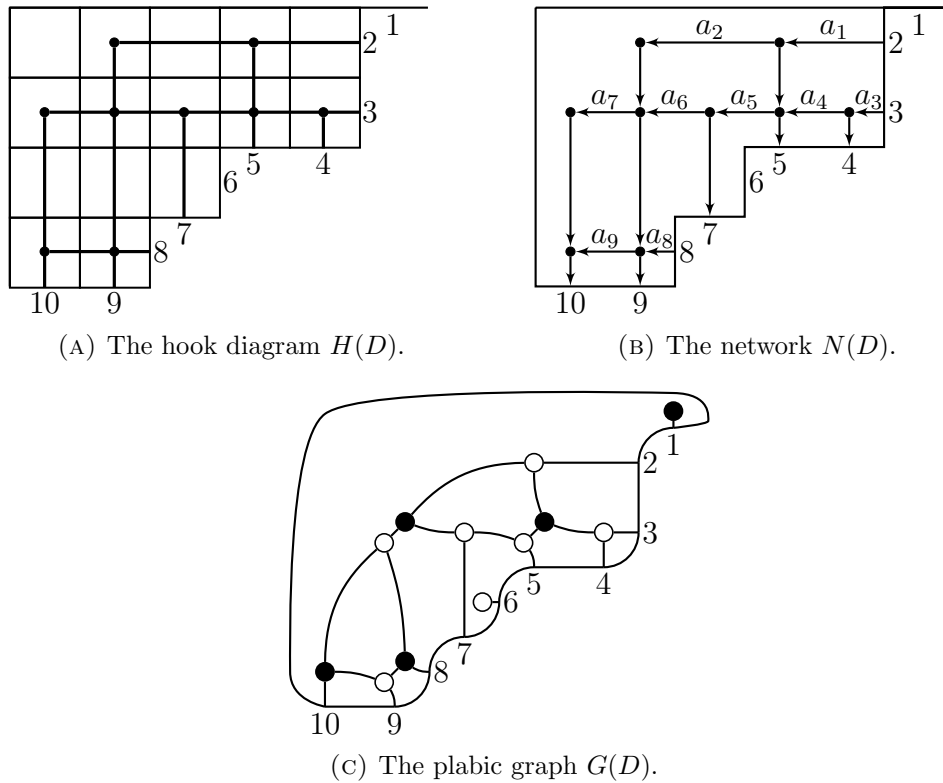

FIGURE 10. The hook diagram, network, and plabic graph associated to the \perp -diagram D from Figure 7.

From the plabic graph constructed in Definition 14.8 (and more generally from a reduced plabic graph G), we can read off the corresponding decorated permutation π_G as follows.

Definition 14.9. Let G be a reduced plabic graph as above with boundary vertices $1, \dots, n$. For each boundary vertex $i \in [n]$, we follow a path along the edges of G starting at i , turning (maximally) right at every internal black vertex, and (maximally) left at every internal white vertex. This path ends at some boundary vertex $\pi(i)$. By [Pos, Section 13], the fact that

G is reduced implies that each fixed point of π is attached to a lollipop; we color each fixed point by the color of its lollipop. In this way we obtain the *decorated permutation* $\pi_G = \pi$ of G . We say that G is of *type* (k, n) , where k is the number of anti-excedances of π_G . By [Pos, Definition 11.5]⁹, we have

$$(14.10) \quad k = \# \text{edges} - \# \text{black vertices} - \sum_{\text{white vertices } v} (\deg(v) - 1).$$

We invite the reader to verify that the decorated permutation of the plabic graph G of Figure 10 is $\pi_G = (\underline{1}, 5, 4, 9, 7, \bar{6}, 2, 10, 3, 8)$. By (14.10), we calculate $k = 21 - 5 - 12 = 4$.

We now explain how to parameterize elements of the cell S_D associated to a \mathbb{J} -diagram D from its network $N(D)$.

Theorem 14.11 ([Pos, Section 6]). *Let D be a \mathbb{J} -diagram of type (k, n) , with associated cell $S_D \subseteq Gr_{k,n}^{\geq 0}$ and network $N(D)$ from Definition 14.8. Let E denote the set of horizontal edges of $N(D)$. We obtain a parameterization $\mathbb{R}_{>0}^E \rightarrow S_D$ of S_D , as follows. Let $s_1 < \dots < s_k$ be the labels of the vertical edges of the southeast border of $N(D)$. Also, to any directed path p of $N(D)$, we define its weight w_p to be the product of the edge variables a_e over all horizontal edges e in p . We let A be the $k \times n$ matrix with rows indexed by $\{s_1, \dots, s_k\}$ whose (s_i, j) -entry equals*

$$(-1)^{|\{i' \in [k]: s_i < s_{i'} < j\}|} \sum_{p: s_i \rightarrow j} w_p,$$

where the sum is over all directed paths p from s_i to j . Then the map sending $(a_e)_{e \in E} \in \mathbb{R}_{>0}^E$ to the element of $Gr_{k,n}^{\geq 0}$ represented by A is a homeomorphism from $\mathbb{R}_{>0}^E$ to S_D .

For example, the network in Figure 10 gives the parameterization

$$\begin{array}{c} \begin{matrix} & 1 & 2 & 3 & 4 & 5 & 6 & 7 & 8 & 9 & 10 \\ \begin{matrix} 2 \\ 3 \\ 6 \\ 8 \end{matrix} & \left[\begin{array}{cccccccccc} 0 & 1 & 0 & 0 & -a_1 & 0 & a_1 a_5 & 0 & -a_1(a_2 + a_5 a_6) & -a_1(a_2 + a_5 a_6)(a_7 + a_9) \\ 0 & 0 & 1 & a_3 & a_3 a_4 & 0 & -a_3 a_4 a_5 & 0 & a_3 a_4 a_5 a_6 & a_3 a_4 a_5 a_6(a_7 + a_9) \\ 0 & 0 & 0 & 0 & 0 & 1 & 0 & 0 & 0 & 0 \\ 0 & 0 & 0 & 0 & 0 & 0 & 0 & 0 & 1 & a_8 & a_8 a_9 \end{array} \right] \end{matrix} \end{array}$$

of $S_D \subseteq Gr_{4,10}^{\geq 0}$, where D is the \mathbb{J} -diagram in Figure 7.

REFERENCES

- [AFR10] Federico Ardila, Alex Fink, and Felipe Rincón. Valuations for matroid polytope subdivisions. *Canad. J. Math.*, 62(6):1228–1245, 2010.
- [AHBC⁺16] Nima Arkani-Hamed, Jacob Bourjaily, Freddy Cachazo, Alexander Goncharov, Alexander Postnikov, and Jaroslav Trnka. *Grassmannian Geometry of Scattering Amplitudes*. Cambridge University Press, 2016. Preliminary version titled “Scattering Amplitudes and the Positive Grassmannian” on the arXiv at <http://arxiv.org/abs/1212.5605>.
- [AHBL17] Nima Arkani-Hamed, Yuntao Bai, and Thomas Lam. Positive Geometries and Canonical Forms. *JHEP*, 11:039, 2017.

⁹There is a typo in Postnikov’s formula: $k + (n - k)$ should read $k - (n - k)$. Our formula looks different than his, but is equivalent.

- [AHCK10] Nima Arkani-Hamed, Freddy Cachazo, Clifford Cheung, and Jared Kaplan. A Duality For The S Matrix. *JHEP*, 03:020, 2010.
- [AHHLT] Nima Arkani-Hamed, Song He, Thomas Lam, and Hugh Thomas. Binary geometries, generalized particles and strings, and cluster algebras. Preprint, [arXiv:1912.11764](#).
- [AHLs_a] Nima Arkani-Hamed, Thomas Lam, and Marcus Spradlin. In preparation.
- [AHLs_b] Nima Arkani-Hamed, Thomas Lam, and Marcus Spradlin. Non-perturbative geometries for planar $\mathcal{N} = 4$ SYM amplitudes. Preprint, [arXiv:1912.08222](#).
- [AHT14] Nima Arkani-Hamed and Jaroslav Trnka. The amplituhedron. *J. High Energy Phys.*, (10):33, 2014.
- [AHTT18] Nima Arkani-Hamed, Hugh Thomas, and Jaroslav Trnka. Unwinding the Amplituhedron in Binary. *JHEP*, 01:016, 2018.
- [AR08] Luis F. Alday and Radu Roiban. Scattering Amplitudes, Wilson Loops and the String/Gauge Theory Correspondence. *Phys. Rept.*, 468:153–211, 2008.
- [ARW16] Federico Ardila, Felipe Rincón, and Lauren Williams. Positroids and non-crossing partitions. *Trans. Amer. Math. Soc.*, 368(1):337–363, 2016.
- [ARW17] Federico Ardila, Felipe Rincón, and Lauren Williams. Positively oriented matroids are realizable. *J. Eur. Math. Soc. (JEMS)*, 19(3):815–833, 2017.
- [Ati82] M. F. Atiyah. Convexity and commuting Hamiltonians. *Bull. London Math. Soc.*, 14(1):1–15, 1982.
- [BC] Francisco Borges and Freddy Cachazo. Generalized Planar Feynman Diagrams: Collections. Preprint, [arXiv:1910.10674](#).
- [BCT] Carolina Benedetti, Anastasia Chavez, and Daniel Tamayo. Quotients of uniform positroids. Preprint, [arXiv:1912.06873](#).
- [BGW03] Alexandre V. Borovik, I. M. Gelfand, and Neil White. *Coxeter matroids*, volume 216 of *Progress in Mathematics*. Birkhäuser Boston, Inc., Boston, MA, 2003.
- [BH] Huanchen Bao and Xuhua He. The $m = 2$ amplituhedron. Preprint, [arXiv:1909.06015](#).
- [BM08] Nathan Berkovits and Juan Maldacena. Fermionic T-Duality, Dual Superconformal Symmetry, and the Amplitude/Wilson Loop Connection. *JHEP*, 09:062, 2008.
- [BMS10] Mathew Bullimore, L. J. Mason, and David Skinner. Twistor-Strings, Grassmannians and Leading Singularities. *JHEP*, 03:070, 2010.
- [Bou] Jacob L. Bourjaily. Positroids, Plabic Graphs, and Scattering Amplitudes in Mathematica. Preprint, [arXiv:1212.6974](#).
- [CEGM19] Freddy Cachazo, Nick Early, Alfredo Guevara, and Sebastian Mizera. Scattering Equations: From Projective Spaces to Tropical Grassmannians. *JHEP*, 06:039, 2019.
- [CGUZ] Freddy Cachazo, Alfredo Guevara, Bruno Umbert, and Yong Zhang. Planar matrices and arrays of feynman diagrams. Preprint, [arXiv:1912.09422](#).
- [DFGK] James Drummond, Jack Foster, mer Grdogan, and Chrysostomos Kalousios. Algebraic singularities of scattering amplitudes from tropical geometry. Preprint, [arXiv:1912.08217](#).
- [DFLP19] David Damgaard, Livia Ferro, Tomasz Lukowski, and Matteo Parisi. The Momentum Amplituhedron. *JHEP*, 08:042, 2019.
- [Ear] Nick Early. Planar kinematic invariants, matroid subdivisions and generalized Feynman diagrams. Preprint, [arXiv:1912.13513](#).
- [Ear19] Nick Early. From weakly separated collections to matroid subdivisions, 2019. Preprint, [arXiv:1910.11522](#).
- [FLOP16] Livia Ferro, Tomasz Lukowski, Andrea Orta, and Matteo Parisi. Towards the Amplituhedron Volume. *JHEP*, 03:014, 2016.
- [FLP19] Livia Ferro, Tomasz Lukowski, and Matteo Parisi. Amplituhedron meets JeffreyKirwan residue. *J. Phys.*, A52(4):045201, 2019.
- [Ful93] William Fulton. *Introduction to toric varieties*, volume 131 of *Annals of Mathematics Studies*. Princeton University Press, Princeton, NJ, 1993. The William H. Roever Lectures in Geometry.

- [GGMS87] I. M. Gelfand, R. M. Goresky, R. D. MacPherson, and V. V. Serganova. Combinatorial geometries, convex polyhedra, and Schubert cells. *Adv. in Math.*, 63(3):301–316, 1987.
- [GGS⁺14] John Golden, Alexander B. Goncharov, Marcus Spradlin, Cristian Vergu, and Anastasia Volovich. Motivic Amplitudes and Cluster Coordinates. *JHEP*, 01:091, 2014.
- [GL] Pavel Galashin and Thomas Lam. Parity duality for the amplituhedron. Preprint, [arXiv:1805.00600](https://arxiv.org/abs/1805.00600).
- [GS82] V. Guillemin and S. Sternberg. Convexity properties of the moment mapping. *Invent. Math.*, 67(3):491–513, 1982.
- [HJJS08] Sven Herrmann, Anders Nedergaard Jensen, Michael Joswig, and Bernd Sturmfels. How to draw tropical planes. *Electr. J. Comb.*, 16, 2008.
- [HJS14] Sven Herrmann, Michael Joswig, and David E. Speyer. Dressians, tropical Grassmannians, and their rays. *Forum Math.*, 26(6):1853–1881, 2014.
- [Hod13] Andrew Hodges. Eliminating spurious poles from gauge-theoretic amplitudes. *JHEP*, 05:135, 2013.
- [Hor19] Szabolcs Horvt. Igraph/m, May 2019. Please go to the GitHub repository to download an immediately usable version of this software, <https://doi.org/10.5281/zenodo.2671660>.
- [HP] Niklas Henke and Georgios Papathanasiou. How tropical are seven- and eight-particle amplitudes? Preprint, [arXiv:1912.08254](https://arxiv.org/abs/1912.08254).
- [Kap93] M. M. Kapranov. Chow quotients of Grassmannians. I. In *I. M. Gelfand Seminar*, volume 16 of *Adv. Soviet Math.*, pages 29–110. Amer. Math. Soc., Providence, RI, 1993.
- [Kar17] Steven N. Karp. Sign variation, the Grassmannian, and total positivity. *J. Combin. Theory Ser. A*, 145:308–339, 2017.
- [KL] Ryota Kojima and Cameron Langer. Sign Flip Triangulations of the Amplituhedron. Preprint, [arXiv:2001.06473](https://arxiv.org/abs/2001.06473).
- [KW17] Steven N. Karp and Lauren K. Williams. The $m = 1$ amplituhedron and cyclic hyperplane arrangements. *Int. Math. Res. Not. IMRN* (to appear), 2017.
- [KWZ] Steven N. Karp, Lauren K. Williams, and Yan X Zhang. Decompositions of amplituhedra. Preprint, [arXiv:1708.09525](https://arxiv.org/abs/1708.09525).
- [Laf03] L. Lafforgue. *Chirurgie des grassmanniennes*, volume 19 of *CRM Monograph Series*. American Mathematical Society, Providence, RI, 2003.
- [LM] Tomasz Lukowski and Robert Moerman. Boundaries of the Amplituhedron with amplituhedronBoundaries. Preprint, [arXiv:2002.07146](https://arxiv.org/abs/2002.07146).
- [LPSV19] Tomasz Lukowski, Matteo Parisi, Marcus Spradlin, and Anastasia Volovich. Cluster Adjacency for $m = 2$ Yangian Invariants. *JHEP*, 10:158, 2019.
- [Luk] Tomasz Lukowski. On the Boundaries of the $m=2$ Amplituhedron. Preprint, [arXiv:1908.00386](https://arxiv.org/abs/1908.00386).
- [Lus94] G. Lusztig. Total positivity in reductive groups. In *Lie theory and geometry*, volume 123 of *Progr. Math.*, pages 531–568. Birkhäuser Boston, Boston, MA, 1994.
- [Oh11] Suho Oh. Positroids and Schubert matroids. *J. Combin. Theory Ser. A*, 118(8):2426–2435, 2011.
- [OPS19] Jorge Alberto Olarte, Marta Panizzut, and Benjamin Schröter. On local Dressians of matroids. In *Algebraic and geometric combinatorics on lattice polytopes*, pages 309–329. World Sci. Publ., Hackensack, NJ, 2019.
- [Oxl11] James Oxley. *Matroid theory*, volume 21 of *Oxford Graduate Texts in Mathematics*. Oxford University Press, Oxford, second edition, 2011.
- [Pos] Alexander Postnikov. Total positivity, Grassmannians, and networks. Preprint, <http://math.mit.edu/~apost/papers/tpgrass.pdf>.
- [PSW09] Alexander Postnikov, David Speyer, and Lauren Williams. Matching polytopes, toric geometry, and the totally non-negative Grassmannian. *J. Algebraic Combin.*, 30(2):173–191, 2009.
- [Rie98] Konstanze Christina Rietsch. *Total Positivity and Real Flag Varieties*. Ph.D. thesis, Massachusetts Institute of Technology, 1998.

- [RVY19] Felipe Rincn, Cynthia Vinzant, and Josephine Yu. Positively hyperbolic varieties, tropicalization, and positroids, 2019.
- [S+] Neil JA Sloane et al. The on-line encyclopedia of integer sequences, 2003–.
- [Sco06] Joshua S. Scott. Grassmannians and cluster algebras. *Proc. London Math. Soc. (3)*, 92(2):345–380, 2006.
- [Spe08] David E. Speyer. Tropical linear spaces. *SIAM J. Discrete Math.*, 22(4):1527–1558, 2008.
- [Spe09] David E. Speyer. A matroid invariant via the K -theory of the Grassmannian. *Adv. Math.*, 221(3):882–913, 2009.
- [SS04] David Speyer and Bernd Sturmfels. The tropical Grassmannian. *Adv. Geom.*, 4(3):389–411, 2004.
- [Stu88] Bernd Sturmfels. Totally positive matrices and cyclic polytopes. In *Proceedings of the Victoria Conference on Combinatorial Matrix Analysis (Victoria, BC, 1987)*, volume 107, pages 275–281, 1988.
- [SW] David Speyer and Lauren Williams. The positive Dressian equals the positive tropical Grassmannian. In preparation.
- [SW05] David Speyer and Lauren Williams. The tropical totally positive Grassmannian. *J. Algebraic Combin.*, 22(2):189–210, 2005.
- [Tal08] Kelli Talaska. A formula for Plücker coordinates associated with a planar network. *Int. Math. Res. Not. IMRN*, 2008, 2008.
- [TW15] E. Tsukerman and L. Williams. Bruhat interval polytopes. *Adv. Math.*, 285:766–810, 2015.

E-mail address: t.lukowski@herts.ac.uk

E-mail address: matteo.parisi@maths.ox.ac.uk

E-mail address: williams@math.harvard.edu