

Sequential Source Coding for Stochastic Systems Subject to Finite Rate Constraints

Photios A. Stavrou, Mikael Skoglund and Takashi Tanaka

Abstract

In this paper, we apply a sequential source coding framework to analyze fundamental performance limitations of stochastic control systems subject to feedback data-rate constraints. We first show that the characterization of the rate-distortion region obtained using sequential codes with a per-time average distortion constraint can be simplified for spatially IID m -order Markov sources and generalized to total (across time) average distortion constraints. Furthermore, we show that the corresponding minimum total-rate achieved by sequential codes is precisely the nonanticipative rate distortion function (NRDF) also known as sequential RDF. We use our findings to derive *analytical* non-asymptotic, finite-dimensional bounds on the minimum achievable performance in two control-related application examples. (a) A parallel time-varying Gauss-Markov process with identically distributed spatial components that is quantized and transmitted with an instantaneous data-rate, obtained through the solution of a dynamic reverse-waterfilling algorithm, through a noiseless channel to a minimum mean-squared error (MMSE) decoder. For this example, we derive non-asymptotic lower and upper bounds (per dimension) on the minimum achievable total-rate. (b) A time-varying quantized LQG closed-loop control system, with identically distributed spatial components and with a random resource allocation. For this example, we apply the results obtained from the quantized state estimation problem to derive analogous bounds on the non-asymptotic total-cost of control.

Index Terms

sequential causal coding, finite-time horizon, bounds, quantization, stochastic systems, reverse-waterfilling.

P. A. Stavrou and M. Skoglund received funding by the KAW Foundation and the Swedish Foundation for Strategic Research. Photios A. Stavrou and Mikael Skoglund are with the Division of Information Science and Engineering, KTH Royal Institute of Technology, Stockholm, Sweden, *emails: {fstavrou, skoglund}@kth.se*

T. Tanaka is with the Department of Aerospace Engineering and Engineering Mechanics, University of Austin, TX, USA, *email: ttanaka@utexas.edu*

I. INTRODUCTION

One of the fundamental characteristics of networked control systems (NCSs) [1] is the existence of an imperfect communication network between computational and physical entities. In such setups, an analytical framework to assess impacts of communication and data-rate limitations on the control performance is strongly required.

In this paper, we adopt information-theoretic tools to analyze these requirements. Specifically, we consider *sequential coding of correlated sources* [2] (see Fig. 1) that is a generalization of the successive refinement source coding problem [3]–[5]. In successive refinement, source coding is performed in (time) stages where one first describes the given source within a few bits of information and, then, tries to “refine” the description of the same source (at the subsequent stages) when more information is available. Sequential coding differs from successive refinement in that at the second stage, encoding involves describing a correlated (in time) source as opposed to improving the description of the same source. To accomplish this task, sequential coding encompasses a spatio-temporal coding method. In addition, sequential coding is a temporally

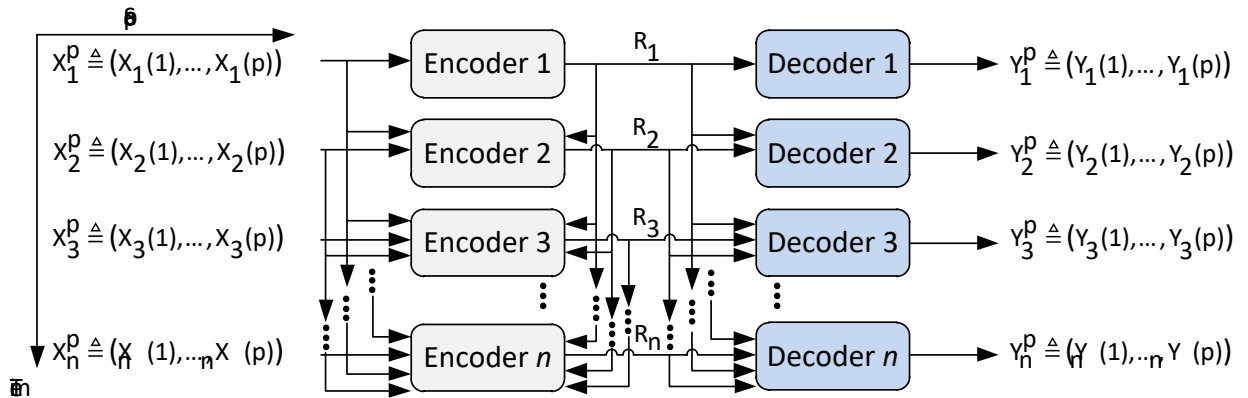

Fig. 1: Sequential coding of correlated sources.

zero-delay coding paradigm since both *encoding* and *decoding* must occur in real-time. The resulting zero-delay coding approach is fundamentally different from the existing works in [6]–[12], because it relies on the use of a spatio-temporal coding approach (see Fig. 1) whereas the latter works rely solely on temporal coding approaches.

A. Literature review on sequential source coding

Sequential source coding of correlated sources [2] was motivated by its utility in video coding applications. The authors of [2] characterized the minimum achievable rate-distortion region for

two temporally correlated random variables with each being a vector of spatially independent and identically distributed (IID) processes (also called “frames” or spatial vectors), subject to a coupled average distortion criterion. Recently, sequential coding was further studied in [13]–[15]. In [13], the authors used an extension of the framework of [2] to three time instants to investigate the effect of sequential coding when possible coding delays occur within a multi-input multi-output distributed system. Around the same time, the authors of [14] generalized the framework of [2] to a finite number of time instants. Compared to [2] and [13], their spatio-temporal source process is correlated over time whereas each frame is spatially jointly stationary and totally ergodic subject to a per-time average distortion criterion. More recently, the same authors in [15] drew connections between sequential causal coding and *predictive sequential causal coding*, that is, for (first-order) Markov sources subject to a single-letter fidelity constraint, sequential causal coding and sequential predictive coding coincide. For three time instants of an IID vector source containing jointly Gaussian correlated processes (not necessarily Markov) an explicit expression of the minimum achievable sum-rate for a per-time mean-squared error (MSE) distortion is obtained in [16].

The connection between the sequential coding and control-related applications was stressed by Khina *et al.* in [17]. In this work, the authors considered a multi-track system that tracks several parallel time-varying Gauss-Markov processes with IID spatial components over a single shared wireless communication link that operates with *fixed data-rate* at each instant. In their scenario, the Gauss-Markov processes are observed by a single observer that translates these measurements into a single spatial vector (frame), maps them into finite-rate packets which are sent to a MMSE estimator. For the previous setup, they derived a lower bound on the optimal performance using the entropy power and Jensen’s inequalities whereas an upper bound is also shown using sequential predictive coding (see for instance differential pulse-code modulation (DPCM) paradigms in [18], [19]). The upper bound coincides with the lower bound for infinitely long spatial components.

B. Contributions

In this paper, we revisit the sequential causal coding framework to obtain the following results.

- (1) We show that the description of the rate-distortion region subject to a per-time average distortion constraint obtained in [13], [14] can be simplified for spatially IID m -order Markov sources (Proposition 1, Theorem 1) and generalized to total (across time) distortion

constraints (Theorem 2). Furthermore, we show that the minimum achievable total-rate coincides with the NRDF introduced in [20] (Proposition 2). This observation provides the NRDF with an operational meaning as the tight lower bound of the minimum total-rates achieved by sequential codes.

- (2) We obtain analytical non-asymptotic and possibly finite-dimensional lower and upper bounds on the minimum achievable total-rates (per-dimension) for a similar multi-track communication system to the one introduced in [17]. Specifically, in contrast to the existing result [17], we allow the instantaneous data-rate conveyed through the noiseless link to be obtained from a total (across time) average distortion criterion. This necessitates the use of a dynamic reverse-waterfilling resource allocation solution (Theorems 3, 4) that we implement in Algorithm 1.
- (3) We obtain analogous bounds to (2) on the minimum achievable total (across time) cost of control (per-dimension) for a NCS with time-varying quantized LQG closed-loops operating with data-rate obtained subject to a solution of a reverse-waterfilling algorithm (Theorems 5, 6).

Discussion of the contributions. The information structures derived in (1) for the minimum achievable total-rate with either total or per-time average distortion constraints complement the results obtained in [21, Section 4], [6]. The non-asymptotic upper bounds in (2) are obtained because we are able to bound a lattice quantizer [22] using a quantization scheme with existing performance guarantees such as the DPCM-based entropy coded-dithered quantization (ECDQ) scheme and by using existing approximations from quantization theory for high-dimensional but possibly finite-dimensional quantizers with a MSE performance criterion (see, e.g., [23]). The non-asymptotic bounds derived in (3) are obtained using the so-called “weak separation principle” of control and estimation (for details, see §V). Moreover, our bounds in (3) reveal the necessary conditions for ensuring non-asymptotic stability of the quantized cost of control for the specific NCS (Remark 5).

This paper is organized as follows. In §II we introduce the notation and give an overview of the sequential coding. In §III we derive information structures on the characterization of the achievable rate-distortion region obtained using sequential causal codes and the minimum achievable total-rate when the source process is modeled as a Markov process subject to either a per-time or total (in time) average distortion constraint. Then, we stress the connection to sequential or NRDF. In §IV, §V, we exemplify the framework of §III by means of two

application examples for which we derive non-asymptotic bounds (per dimension) on the optimal performance. We draw conclusions and discuss future directions in §VI.

Notation: \mathbb{R} is the set of real numbers, \mathbb{N}_1 is the set of positive integers, and $\mathbb{N}_1^n \triangleq \{1, \dots, n\}$, $n \in \mathbb{N}_1$, respectively. Let \mathbb{X} be a finite-dimensional Euclidean space, and $\mathcal{B}(\mathbb{X})$ be the Borel σ -algebra on \mathbb{X} . A random variable (RV) X defined on some probability space $(\Omega, \mathcal{F}, \mathbf{P})$ is a map $X : \Omega \mapsto \mathbb{X}$. The probability distribution of a RV X with realization $X = x$ on \mathbb{X} is denoted by $\mathbf{P}_X \equiv p(x)$. The conditional distribution of a RV Y with realization $Y = y$, given $X = x$ is denoted by $\mathbf{Q}_{Y|X} \equiv q(y|x)$. We denote by $\mathbf{E}\{\cdot\}$ the expectation operator. We denote the sequence of one-sided RVs by $X_{t,j} \triangleq (X_t, X_{t+1}, \dots, X_j)$, $t \leq j$, $(t, j) \in \mathbb{N}_1 \times \mathbb{N}_1$, and their values by $x_{t,j} \in \mathbb{X}_{t,j} \triangleq \times_{k=t}^j \mathbb{X}_k$. We denote the sequence of ordered RVs with “ i th” spatial components by $X_{t,j}^i$, so that $X_{t,j}^i$ is a vector of dimension “ i ”, and their values by $x_{t,j}^i \in \mathbb{X}_{t,j}^i \triangleq \times_{k=t}^j \mathbb{X}_k^i$, where $\mathbb{X}_k^i \triangleq (\mathbb{X}_k(1), \dots, \mathbb{X}_k(i))$. The notation $X \leftrightarrow Y \leftrightarrow Z$ denotes a Markov Chain (MC) which means that $p(x|y, z) = p(x|y)$. We denote the diagonal of a square matrix by $\text{diag}(\cdot)$. If $A \in \mathbb{R}^{p \times p}$, we denote by $A \succeq 0$ (resp., $A \succ 0$) a positive semidefinite matrix (resp., positive definite matrix). We denote the determinant of some matrix $A \in \mathbb{R}^{p \times p}$ by $|A|$. We denote by $h(x)$ (resp. $h(x|y)$) the differential entropy of a distribution $p(x)$ (resp. $p(x|y)$). Unless otherwise stated, when we say “total” (average) distortion or “total-rate” we mean with respect to the time.

II. SYNOPSIS OF SEQUENTIAL CODING

In this section, we give an overview of sequential causal coding introduced and analyzed in [13], [14] when the spatio-temporal processes are temporally correlated with IID spatial components.

In the following analysis, we will consider processes for a fixed time-span $t \in \mathbb{N}_1^n$, i.e., (X_1, \dots, X_t) . Following [13], [14], we assume that the sequences of RVs are defined on alphabet spaces with finite cardinality. Nevertheless, these can be extended following for instance the techniques employed in [24] to continuous alphabet spaces as well (i.e., Gaussian processes) with MSE distortion constraints.

First, we use some definitions (with slight modifications to ease the readability of the paper) from [13, §II] and [14, §I].

Definition 1. (*Sequential causal coding*)

A spatial order p sequential causal code \mathcal{C}_p for the (joint) vector source $(X_1^p, X_2^p, \dots, X_n^p)$ is formally defined by a sequence of encoder and decoder pairs $(f_1^{(p)}, g_1^{(p)}), \dots, (f_n^{(p)}, g_n^{(p)})$ such that

$$\begin{aligned} f_t^{(p)} &: \mathbb{X}_{1,t}^p \times \underbrace{\{0, 1\}^* \times \dots \times \{0, 1\}^*}_{t-1 \text{ times}} \longrightarrow \{0, 1\}^* \\ g_t^{(p)} &: \underbrace{\{0, 1\}^* \times \dots \times \{0, 1\}^*}_{t \text{ times}} \longrightarrow \mathbb{Y}_t^p, \quad t \in \mathbb{N}_1^n \end{aligned} \quad (1)$$

where $\{0, 1\}^*$ denotes the set of all binary sequences of finite length satisfying the property that at each time instant t the range of $\{f_t : t \in \mathbb{N}_1^n\}$ given any $t - 1$ binary sequences is an instantaneous code. Moreover, the encoded and reconstructed sequences of $\{X_t^p : t \in \mathbb{N}_1^n\}$ are given by $S_t = f_t(X_{1,t}^p, S_{1,t-1})$, with $S_t \in \mathbb{S}_t \subset \{0, 1\}^*$, and $Y_t^p = g_t(S_{1,t})$, respectively, with $|\mathbb{Y}_t| < \infty$. Moreover, the expected rate in bits per symbol at each time instant (normalized over the spatial components) is defined as

$$r_t \triangleq \frac{\mathbf{E}|S_t|}{p}, \quad t \in \mathbb{N}_1^n, \quad (2)$$

where $|S_t|$ denotes the length of the binary sequence S_t .

Distortion criterion: For each $t \in \mathbb{N}_1^n$, we consider a total (in dimension) single-letter distortion criterion. This means that the distortion between X_t^p and Y_t^p is measured by a function $d_t : \mathbb{X}_t^p \times \mathbb{Y}_t^p \longrightarrow [0, \infty)$ with maximum distortion $d_t^{\max} = \max_{x_t^p, y_t^p} d_t(x_t^p, y_t^p) < \infty$ such that

$$d_t(x_t^p, y_t^p) \triangleq \frac{1}{p} \sum_{i=1}^p d_t(x_t(i), y_t(i)). \quad (3)$$

The per-time average distortion is defined as

$$\mathbf{E} \{d_t(X_t^p, Y_t^p)\} \triangleq \frac{1}{p} \sum_{i=1}^p \mathbf{E} \{d_t(X_t(i), Y_t(i))\}. \quad (4)$$

We remark that the following results are still valid even if the distortion function (3) has dependency on previous reproductions $\{Y_{1,t-1}^p : t \in \mathbb{N}_1^n\}$ (see, e.g., [13]).

Definition 2. (Achievability)

A rate-distortion tuple $(R_{1,n}, D_{1,n}) \triangleq (R_1, \dots, R_n, D_1, \dots, D_n)$ for any “ n ” is said to be achievable for a given sequential causal coding system if for all $\epsilon > 0$, there exists a sequential

code $\{(f_t^{(p)}, g_t^{(p)}) : t \in \mathbb{N}_1^n\}$ for all sufficiently large p , such that

$$r_t \leq R_t + \epsilon, \quad (5)$$

$$\mathbf{E} \{d_t(X_t^p, Y_t^p)\} \leq D_t + \epsilon, \quad D_t \geq 0, \quad \forall t \in \mathbb{N}_1^n.$$

Moreover, let the set of all achievable rate-distortion tuples $(R_{1,n}, D_{1,n})$ be denoted by \mathcal{R}^* . Then, the minimum total-rate required to achieve the distortion tuple (D_1, D_2, \dots, D_n) is defined by the following optimization problem:

$$\mathcal{R}_{\text{sum}}(D_{1,n}) \triangleq \inf_{(R_{1,n}, D_{1,n}) \in \mathcal{R}^*} \sum_{t=1}^n R_t. \quad (6)$$

Source model: The finite alphabet source randomly generates symbols $X_{1,n}^p = x_{1,n}^p \in \mathbb{X}_{1,n}^p$ according to the n -order PMF

$$\mathbf{P}_{X_{1,n}^p} \equiv p(x_{1,n}^p) \triangleq p(x_1^p) \prod_{t=2}^n p(x_t^p | x_{1,t-1}^p), \quad (7)$$

where we have assumed initial value for $p(x_1^p | x_{-\infty,0}^p) = p(x_1^p)$, that is, the source process $(x_{-\infty}^p, \dots, x_0^p)$ generates trivial information. For the source model of (7) it is assumed that the spatio-temporal (joint) distribution is temporally correlated with spatially IID components, i.e., $p(x_1(i), \dots, x_n(i)) = p(x_1, \dots, x_n)$, $\forall i \in \mathbb{N}_1^p$.

Achievable rate-distortion regions and minimum achievable total-rate: Next, we characterize the achievable rate-distortion regions and the minimum achievable total-rate for the source model (7) with the distortion constraint (4).

The following lemma is given in [14, Theorem 5].

Lemma 1. (*Achievable rate-distortion region*)

Consider the source model (7) with the average distortion of (4). Then, the “spatially” single-letter characterization of the rate-distortion region $(R_{1,n}, D_{1,n})$, hereinafter denoted by \mathcal{R}^{IID} ,

is obtained as follows:

$$\begin{aligned}
\mathcal{R}^{\text{IID}} &= \left\{ (R_{1,n}, D_{1,n}) \left| \exists S_{1,n-1}, Y_{1,n}, \{g_t(\cdot)\}_{t=1}^n, \right. \right. \\
\text{s.t.} \quad R_1 &\geq I(X_1; S_1), \text{ (initial time)} \\
R_t &\geq I(X_{1,t}; S_t | S_{1,t-1}), \quad t = 2, \dots, n-1, \\
R_n &\geq I(X_{1,n}; Y_n | S_{1,n-1}), \text{ (terminal time),} \\
D_t &\geq \mathbf{E} \{d_t(X_t, Y_t)\}, \quad t \in \mathbb{N}_1^n, \\
Y_1 &= g_1(S_1), \quad Y_t = g_t(S_{1,t}), \quad t = 2, \dots, n-1, \\
S_1 &\leftrightarrow (X_1) \leftrightarrow X_{2,n}, \\
S_t &\leftrightarrow (X_{1,t}, S_{1,t-1}) \leftrightarrow X_{t+1,n}, \quad t = 2, \dots, n-1 \left. \right\}, \tag{8}
\end{aligned}$$

where $\{S_{1,n-1}, Y_{1,n}\}$ are the auxiliary (encoded) and reproduction RVs, respectively, taking values in some finite alphabet spaces $\{\mathbb{S}_{1,n-1}, \mathbb{Y}_{1,n}\}$, and $\{g_t(\cdot) : t \in \mathbb{N}_1^n\}$ are deterministic functions.

Remark 1. (Comments on Lemma 1)

In the characterization of Lemma 1, the spatial index is excluded because the rate and distortion regions are normalized with the total number of spatial components. This point is also shown in [14, Theorem 4]. Following [13] or [14], Lemma 1 gives a set \mathcal{R}^{IID} that is convex and closed (this can be shown by trivially generalizing the time-sharing and continuity arguments of [13, Appendix C2] to n time-steps). This in turn means that $\mathcal{R}^* = \mathcal{R}^{\text{IID}}$ (see, e.g., [14, Theorem 5]). Thus, (6) can be reformulated to the following optimization problem:

$$\mathcal{R}_{\text{sum}}^{\text{IID,op}}(D_{1,n}) \triangleq \min_{(R_{1,n}, D_{1,n}) \in \mathcal{R}^{\text{IID}}} \sum_{t=1}^n R_t. \tag{9}$$

The next lemma states a lower bound to the characterization of (9) that is tight if and only if $S_t = Y_t, \forall t$.

Lemma 2. (Minimum achievable total-rate of Lemma 1)

The characterization of the minimum achievable total-rate in (9) can be lower bounded as

follows:

$$\begin{aligned} \mathcal{R}_{\text{sum}}^{\text{IID,op}}(D_{1,n}) &\stackrel{(a)}{\geq} \mathcal{R}_{\text{sum}}^{\text{IID}}(D_{1,n}) \\ &\triangleq \min_{\substack{\mathbf{E}\{d_t(X_t, Y_t)\} \leq D_t, \quad t \in \mathbb{N}_1^n \\ Y_1 \leftrightarrow X_1 \leftrightarrow X_{2,n}, \\ Y_t \leftrightarrow (X_{1,t}, Y_{1,t-1}) \leftrightarrow X_{t+1,n}, \quad t=2, \dots, n-1}} I(X_{1,n}; Y_{1,n}), \end{aligned} \quad (10)$$

where (a) holds with equality if and only if (i) $S_t = Y_t$ for any $t \in \mathbb{N}_1^n$ and (ii) $I(X_{1,n}; Y_{1,n}) = \sum_{t=1}^n I(X_{1,t}; Y_t | Y_{1,t-1})$ is a variant of directed information [25], [26] obtained by the conditional independence constraints imposed in the constraint set of (10).

Proof. The proof is an extension of the three time-step proof derived in [13, Corollary 1.1] to n -time steps. \square

Remark 2. (Comments on the achievability of Lemma 2)

Lemma 2 demonstrates that, in general, we have $\mathcal{R}_{\text{sum}}^{\text{IID,op}}(D_{1,n}) \geq \mathcal{R}_{\text{sum}}^{\text{IID}}(D_{1,n})$. However, it is also stressed that this bound is achieved if and only if the optimal minimizer or “test-channel” at each time instant in (10), corresponds precisely to the distribution generated by a sequential encoder, i.e., $S_t = Y_t$, for any $t \in \mathbb{N}_1^n$. In other words, the bound is tight if the encoder (or quantizer for continuous alphabet sources) simulates exactly the corresponding “test-channel” distribution of (10). Note that in general, this idealization is very hard to be achieved. However, as demonstrated in [27] it is true for all sources that are IID. In the sequential coding setup, this idealization holds as the block-length of the IID spatial components tends to infinity, i.e., $p \rightarrow \infty$. This is demonstrated via an application example for jointly Gaussian RVs and MSE distortion in [13, Corollary 1.2].

III. THEORETICAL RESULTS

In this section, we show that if the source is an m -order Markov process, the description of the rate-distortion region in Lemma 1, and the characterization of the minimum achievable total-rate in Lemma 2 can be simplified. Moreover, we generalize Lemma 2 to total average distortion constraints. Finally, we show that if the spatio-temporal source process is spatially IID, then, the optimization problem of Lemma 2 is precisely the NRDF, also known as sequential RDF.

First, we let the source model to be an m -order Markov process, i.e.,

$$\mathbf{P}_{X_{1,n}^p} \equiv p(x_{1,n}^p) \triangleq p(x_1^p) \prod_{t=2}^n p(x_t^p | x_{t-m,t-1}^p), \quad (11)$$

where $m = \{1, \dots, t\}$, $t \in \mathbb{N}_1^n$, that is assume to be fixed. Then, the following proposition holds.

Proposition 1. (Structural result of Lemma 1)

Consider the source model in (11) for a fixed m , and the average distortion of (4). Then, the single-letter characterization of the rate-distortion tuples $(R_{1,n}, D_{1,n})$ in Lemma 1 can be simplified as follows:

$$\begin{aligned} \mathcal{R}^{\text{IID},m} = & \left\{ (R_{1,n}, D_{1,n}) \left| \exists S_{1,n-1}, Y_{1,n}, \{g_t(\cdot)\}_{t=1}^n, \right. \right. \\ & \text{s.t. } R_1 \geq I(X_1; S_1), \text{ (initial time)} \\ & R_t \geq I(X_{t+1-m,t}; S_t | S_{1,t-1}), \quad t = 2, \dots, n-1, \\ & R_n \geq I(X_{n+1-m,n}; Y_n | S_{1,n-1}), \text{ (terminal time),} \\ & D_t \geq \mathbf{E} \{d_t(X_t, Y_t)\}, \quad t \in \mathbb{N}_1^n, \\ & Y_1 = g_1(S_1), \quad Y_t = g_t(S_{1,t}), \quad t = 2, \dots, n-1, \\ & S_1 \leftrightarrow (X_1) \leftrightarrow X_{2,n}, \\ & \left. S_t \leftrightarrow (X_{t+1-m,t}, S_{1,t-1}) \leftrightarrow (X_{1,t-m}, X_{t+1,n}) \right\}, \end{aligned} \quad (12)$$

where the last MC in (12) holds for $t = 2, \dots, n-1$.

Proof. By Lemma 1 it is sufficient to show in (8) that $I(X_{1,t}; S_t | S_{1,t-1}) = I(X_{t+1-m,t}; S_t | S_{1,t-1})$, $\forall t \in \mathbb{N}_1^{n-1}$ and $I(X_{1,n}; Y_n | S_{1,n-1}) = I(X_{n+1-m,t}; Y_n | S_{1,n-1})$ at $t = n$. Observe that Lemma 1 provides a characterization of a source coding problem. By definition, in source coding problems the information source process (in this case is the joint process (X_1, \dots, X_n)) is given and assumed to be fixed. This means that one can specify at each time step of (8) the given information structure of the source process. Thus, the result follows. This completes the proof. \square

Using Proposition 1, the minimum achievable total-rate can now be simplified to the following

optimization problem:

$$\mathcal{R}_{\text{sum}}^{\text{IID,op},m}(D_{1,n}) \triangleq \min_{(R_{1,n}, D_{1,n}) \in \mathcal{R}^{\text{IID},m}} \sum_{t=1}^n R_t. \quad (13)$$

In the next theorem, we use Proposition 1 to generalize Lemma 2 to spatially IID m – order Markov processes.

Theorem 1. (Structural result of Lemma 2)

Consider the source model in (11) with fixed m , and the average distortion criterion of (4).

Then,

$$\begin{aligned} \mathcal{R}_{\text{sum}}^{\text{IID,op},m}(D_{1,n}) &\stackrel{(a)}{\geq} \mathcal{R}_{\text{sum}}^{\text{IID},m}(D_{1,n}) \\ &= \min_{\substack{\mathbf{E}\{d_t(X_t, Y_t)\} \leq D_t, \quad t \in \mathbb{N}_1^n \\ Y_1 \leftrightarrow X_1 \leftrightarrow X_{2,n}, \\ Y_t \leftrightarrow (X_{t+1-m,t}, Y_{1,t-1}) \leftrightarrow (X_{1,t-m}, X_{t+1,n}), \quad t \in \mathbb{N}_2^{n-1}}} I(X_{1,n}; Y_{1,n}), \end{aligned} \quad (14)$$

where (a) holds if and only if $S_t = Y_t, \forall t \in \mathbb{N}_1^n$; $I(X_{1,n}; Y_{1,n}) = \sum_{t=1}^n I(X_{t+1-m,t}; Y_t | Y_{1,t-1})$ is obtained because of the conditional independence constraints imposed in the constraint set of (14).

Proof. See Appendix A. □

In the following theorem, we generalize Lemma 2 to total average distortion constraints.

Theorem 2. (Generalization of Lemma 2)

The minimum achievable total-rate in Lemma 1 can be characterized subject to a total average distortion constraint as follows:

$$\begin{aligned} \mathcal{R}_{\text{sum}}^{\text{IID,op}}(D) &\stackrel{(a)}{\geq} \mathcal{R}_{\text{sum}}^{\text{IID}}(D) \\ &= \min_{\substack{\frac{1}{n} \sum_{t=1}^n \mathbf{E}\{d_t(X_t, Y_t)\} \leq D, \quad t \in \mathbb{N}_1^n \\ Y_1 \leftrightarrow (X_1) \leftrightarrow X_{2,n}, \\ Y_t \leftrightarrow (X_{1,t}, Y_{1,t-1}) \leftrightarrow X_{t+1,n}, \quad t \in \mathbb{N}_2^{n-1}}} I(X_{1,n}; Y_{1,n}), \end{aligned} \quad (15)$$

where (a) holds if and only if $S_t = Y_t, \forall t \in \mathbb{N}_1^n$; $\frac{1}{n} \sum_{t=1}^n \mathbf{E}\{d_t(X_t, Y_t)\} \leq D$ denotes the total average distortion constraint with $\mathbf{E}\{d_t(X_t, Y_t)\}$ defined as in (4).

Proof. See Appendix B. □

Remark 3. (Comments on Theorem 2)

Clearly, using Proposition 1 one can generalize Theorem 2 to m – order Markov sources (with the appropriate MCs) following precisely the approach put forward in Theorem 2.

Connections to NRDF: Next, we demonstrate that the minimum total-rate achieved by sequential codes is precisely the NRDF introduced in [20], [28] for per-time average distortion constraints and in [12], [21], [29] for total average distortion constraints. To do so, we recall the definition of NRDF with total distortion constraints (the one with per-time constraints follows similarly and we omit it).

Definition 3. (NRDF) [21, Equation (3.15)]

The NRDF, denoted by $R_{1,n}^{\text{na}}(D)$, is defined as:

$$R_{1,n}^{\text{na}}(D) \triangleq \min_{\substack{\frac{1}{n} \sum_{t=1}^n \mathbf{E}\{d_t(X_t, Y_t)\} \leq D \\ Y_1 \leftrightarrow (X_1) \leftrightarrow X_{2,n} \\ Y_{1,t} \leftrightarrow (X_{1,t}) \leftrightarrow X_{t+1,n}, \forall t}} I(X_{1,n}; Y_{1,n}). \quad (16)$$

Using Definition 3, we get the following proposition.

Proposition 2. ($\mathcal{R}_{\text{sum}}^{\text{IID}}(D) = R_{1,n}^{\text{na}}(D)$)

For spatio-temporal processes that are temporally correlated and spatially IID, we obtain

$$\mathcal{R}_{\text{sum}}^{\text{IID}}(D) = R_{1,n}^{\text{na}}(D). \quad (17)$$

Proof. This follows once it is observed that the conditional independence constraints in Theorem 2 correspond precisely to the conditional independence constraints of $R_{1,n}^{\text{na}}(D)$, see, e.g., [29, Lemma II.6] or [21, Remark 1]. \square

Proposition 2 provides the well-studied information metric $R_{1,n}^{\text{na}}(D)$ with an operation meaning as the tight lower bound to the total-rate achievable by sequential codes.

IV. APPLICATION IN STATE ESTIMATION

In this section, we apply the sequential coding framework of the previous section to a state estimation problem and obtain new results in such applications.

We consider a similar scenario to [17, §II] where a multi-track system estimates several “parallel” Gaussian processes over a single shared communication link as illustrated in Fig. 2. Following the sequential coding framework, we require the Gaussian source processes to have temporally correlated and spatially IID components, which are observed by an observer who

collects the measured states into a single vector state. Then, the observer/encoder maps the states as random finite-rate packets to a MMSE estimator through a noiseless link. Compared to the setup of [17, §II] which presupposes per-time average distortion constraint and fixed-data rate, here we assume total average distortion constraint which necessitates the use of random data-rate at each time instant to be conveyed through the noiseless link.

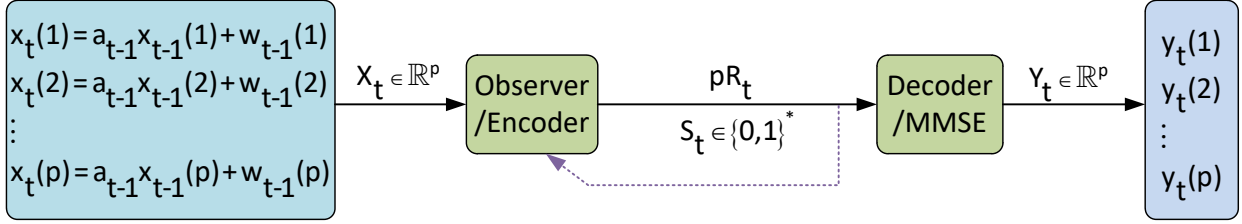

Fig. 2: Multi-track state estimation system model.

First, we describe the problem of interest.

State process. Consider p -parallel time-varying Gauss-Markov processes with IID spatial components as follows:

$$x_t(i) = \alpha_{t-1}x_{t-1}(i) + w_{t-1}(i), \quad i \in \mathbb{N}_1^p, \quad t \in \mathbb{N}_2^n, \quad (18)$$

where $x_1(i) \equiv x_1$ is given, with $x_1 \sim \mathcal{N}(0; \sigma_{x_1}^2)$; the non-random coefficient $\alpha_t \in \mathbb{R}$ is known at each time step t , and $\{w_t(i) \equiv w_t : i \in \mathbb{N}_1^p\}$, $w_t \sim \mathcal{N}(0; \sigma_{w_t}^2)$, is an independent Gaussian noise process at each t , independent of $x_1, \forall i \in \mathbb{N}_1^p$. Since (18) has IID spatial components it can be compactly written as a vector or frame as follows:

$$X_t = A_{t-1}X_{t-1} + W_{t-1}, \quad X_1 = \text{given}, \quad t \in \mathbb{N}_2^n, \quad (19)$$

where $A_{t-1} = \text{diag}(\alpha_{t-1}, \dots, \alpha_{t-1}) \in \mathbb{R}^{p \times p}$, $X_t \in \mathbb{R}^p$, and the independent Gaussian noise process $W_t \in \mathbb{R}^p$ (that is spatially IID) is independent of the initial state X_1 .

Observer/Encoder. At the observer the spatially IID time-varying \mathbb{R}^p -valued Gauss-Markov processes are collected into a frame $X_t \in \mathbb{R}^p$ and mapped using sequential coding with encoded sequence:

$$S_t = f_t(X_{1,t}, S_{1,t-1}), \quad (20)$$

where at $t = 1$ we assume $S_1 = f_1(X_1)$, and $R_t = \frac{\mathbf{E}|S_t|}{p}$ is the expected (random) rate (per

dimension) at each time instant t transmitted through the noiseless link.

MMSE Decoder. The data packet S_t is received using the following reconstructed sequence:

$$Y_t = g_t(S_{1,t}), \quad (21)$$

where at $t = 1$ we have $Y_1 = g_1(S_1)$.

Distortion. We consider the total MSE distortion normalized over all spatial components as follows:

$$D \triangleq \frac{1}{n} \sum_{t=1}^n D_t, \quad D_t \triangleq \frac{1}{p} \mathbf{E} \{ \|X_t - Y_t\|_2^2 \}. \quad (22)$$

Performance. The performance of the above system (per dimension) can be cast to the following optimization problem:

$$\mathcal{R}_{\text{sum}}^{\text{IID,op,1}}(D) = \min_{\substack{(f_t, g_t): t=1, \dots, n \\ \frac{1}{n} \sum_{t=1}^n D_t \leq D}} \sum_{t=1}^n R_t. \quad (23)$$

In what follows, we prove the following theorem.

Theorem 3. (Non-asymptotic performance for Fig. 2)

(1) For the multi-track system in Fig. 2, the minimum achievable total-rate for any “ n ” and any p , however large, is $\mathcal{R}_{\text{sum}}^{\text{IID,op,1}}(D) = \sum_{t=1}^n R_t$ with the minimum achievable rate distortion at each time instant (per dimension) given by some $R_t \geq R_t^*$ such that

$$R_t^* = \frac{1}{2} \log_2 \left(\frac{\lambda_t}{D_t} \right), \quad (24)$$

where $\lambda_t \triangleq \alpha_{t-1}^2 D_{t-1} + \sigma_{w_{t-1}}^2$ and D_t is the distortion at each time instant evaluated based on a dynamic reverse-waterfilling algorithm operating forward in time. The algorithm is as follows:

$$D_t \triangleq \begin{cases} \xi_t & \text{if } \xi_t \leq \lambda_t \\ \lambda_t & \text{if } \xi_t > \lambda_t \end{cases}, \quad \forall t, \quad (25)$$

with $\sum_{t=1}^n D_t = nD$, and

$$\xi_t = \begin{cases} \frac{1}{2\beta_t^2} \left(\sqrt{1 + \frac{2\beta_t^2}{\theta}} - 1 \right), & \forall t \in \mathbb{N}_1^{n-1} \\ \frac{1}{2\theta}, & t = n \end{cases}, \quad (26)$$

where $\theta > 0$ is the Lagrangian multiplier tuned to obtain equality $\sum_{t=1}^n D_t = nD$, $\beta_t^2 \triangleq \frac{\alpha_t^2}{\sigma_{w_t}^2}$, and $D \in (0, \infty)$.

(2) If we consider a DPCM predictive coding scheme with an MMSE \mathbb{R}^p -valued quantizer in (23) that “simulates” precisely the Gaussian test-channel distribution corresponding to R_t^* , $\forall t$, then, the minimum achievable total-rate for the multi-track setting in Fig. 2 is given by $\mathcal{R}_{\text{sum}}^{\text{IID,op,1}}(D) = \sum_{t=1}^n R_t$ such that the achievable rate $R_t = R_t^*$. Thus,

$$\mathcal{R}_{\text{sum}}^{\text{IID,op,1}}(D) = \frac{1}{2} \sum_{t=1}^n \log_2 \left(\frac{\lambda_t}{D_t} \right), \quad (27)$$

with all the statements in (1) to hold.

Proof. See Appendix C. □

We remark the following comments for Theorem 3.

Remark 4. (Comments on Theorem 3)

(1) The “realization” of an “ideal” quantizer in Theorem 3, (2), can, in general, only be achieved if the number of dimensions within the system becomes infinitely large, i.e., $p \rightarrow \infty$.

(2) Theorem 3 is the analogue of Theorem 2 obtained for parallel Gauss-Markov processes with a total MSE distortion constraint.

(3) It is a generalization of [17, Theorem 1] since it considers a more general distortion criterion that requires the solution of a dynamic reverse-waterfilling optimization algorithm.

It should be remarked that a way to implement the reverse-waterfilling algorithm in Theorem 3 is proposed in [30, Algorithm 1]. A different algorithm using the bisection method (for details see, e.g., [31, Chapter 2.1]) is proposed in Algorithm 1. The method in Algorithm 1 guarantees global convergence and it converges linearly with rate $\frac{1}{2}$. On the other hand, [30, Algorithm 1] requires a specific proportionality gain factor $\gamma \in (0, 1]$ chosen appropriately at each time instant. The choice of γ affects the rate of convergence whereas it does not guarantee global convergence of the algorithm. In Fig. 3, we illustrate a numerical simulation using Algorithm 1 by taking $a_t \in (0, 2)$, $\sigma_{w_t}^2 = 1$, for $t = \{1, 2, \dots, 200\}$ and $D = 1$.

Upper bounds to the minimum achievable total-rate: In the next theorem, we employ a sequential causal DPCM-based scheme using pre/post filtered ECDQ (for details, see [22, Chapter 5]) which ensures standard performance guarantees on the minimum achievable sum-

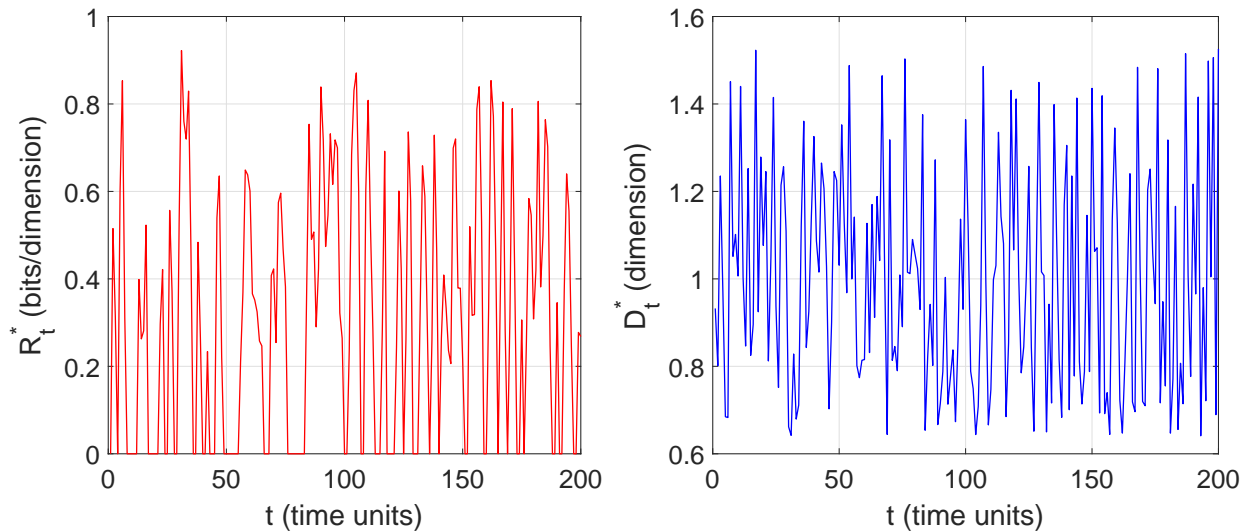

Fig. 3: Dynamic Rate-distortion allocation of the system in Fig. 2.

Algorithm 1 Dynamic reverse-waterfilling algorithm

Initialize: number of time-steps n ; distortion level D ; error tolerance ϵ ; error tolerance ϵ ; nominal minimum and maximum value $\theta^{\min} = 0$ and $\theta^{\max} = \frac{1}{2D}$; initial variance $\lambda_1 = \sigma_{X_1}^2$ of the initial state x_1 , values a_t and $\sigma_{w_t}^2$ of (18).

Set $\theta = 1/2D$; flag = 0.

while flag = 0 **do**

 Compute $D_t \forall t$ as follows:

for $t = 1 : n$ **do**

 Compute ξ_t according to (26).

 Compute D_t according to (25).

if $t < n$ **then**

 Compute λ_{t+1} according to $\lambda_{t+1} \triangleq \alpha_t^2 D_t + \sigma_{w_t}^2$.

end if

end for

if $\theta^{\max} - \theta^{\min} \geq \epsilon$ **then**

if $\frac{1}{n} \sum D_t - D \geq \epsilon$ **then**

 Set $\theta^{\min} = \frac{\theta}{n}$.

else

 Set $\theta^{\max} = \frac{\theta}{n}$.

end if

 Compute $\theta = \frac{n(\theta^{\min} + \theta^{\max})}{2}$.

else

 flag \leftarrow 1

end if

end while

Output: $\{D_t : t \in \mathbb{N}_1^n\}$, $\{\lambda_t : t \in \mathbb{N}_1^n\}$, for a given distortion level D .

rate $\mathcal{R}_{\text{sum}}^{\text{IID,op},1}(D) = \sum_{t=1}^n R_t$, to obtain an upper bound to the performance of the multi-track setup of Fig. 2. The reason for the choice of this quantization scheme is twofold. First, it can be implemented in practice and, second, it allows to find analytical achievable bounds and approximations on finite-dimensional quantizers which generate near-Gaussian quantization noise and Gaussian quantization noise for infinite dimensional quantizers [22].

Theorem 4. (*Upper bound to $\mathcal{R}_{\text{sum}}^{\text{IID,op},1}(D)$*)

Suppose that in (23) we apply a sequential causal ECDQ-based DPCM predictive coding scheme with an \mathbb{R}^p -valued lattice quantizer. Then, the minimum achievable total-rate $\mathcal{R}_{\text{sum}}^{\text{IID,op},1}(D) = \sum_{t=1}^n R_t^{\text{ECDQ}}$, where at each time instant R_t^{ECDQ} is upper bounded as follows:

$$R_t^{\text{ECDQ}} \leq R_t^* + \frac{1}{2} \log_2(2\pi e G_p) + \frac{1}{p}, \quad \forall t, \quad (\text{bits/dimension}), \quad (28)$$

where R_t^* is obtained from Theorem 3, (1), $\frac{1}{2} \log_2(2\pi e G_p)$ is the divergence of the quantization noise from Gaussianity; G_p is the dimensionless normalized second moment of the lattice [22, Chapter 3, Definition 3.2.2] and $\frac{1}{p}$ is the additional cost due to having prefix-free (instantaneous) coding.

Proof. See Appendix D. □

Recently in [32], it is pointed out that for discrete-time processes one can assume in the ECDQ coding scheme the clocks of the entropy encoder and the entropy decoder to be synchronized, thus, eliminating the additional rate-loss due to prefix-free coding. This assumption, will give a better upper bound in Theorem 4 because the term $\frac{1}{p}$ will be removed.

Computation of Theorem 4: Unfortunately, finding G_p in (28) for good high-dimensional quantizers of possibly finite dimension is currently an open problem (although it can be approximated for any dimension using for example product lattices [23]). Therefore, in what follows we propose existing computable bounds to the achievable upper bound of Theorem 4 for any high-dimensional lattice quantizer. Note that these bounds were derived as a consequence of the main result by Zador [23], namely, it is possible to reduce the MSE distortion normalized per dimension using higher-dimensional quantizers. Toward this end, Zador introduced a lower bound on G_p using the dimensionless normalized second moment of a p -dimensional sphere,

hereinafter denoted by $G(S_p)$, for which it holds that:

$$G(S_p) = \frac{1}{(p+2)\pi} \Gamma\left(\frac{p}{2} + 1\right)^{\frac{2}{p}}, \quad (29)$$

where $\Gamma(\cdot)$ is the gamma function. Moreover, G_p and $G(S_p)$ are connected via the following inequalities:

$$\frac{1}{2\pi e} \stackrel{(a)}{\leq} G(S_p) \stackrel{(b)}{\leq} G_p \stackrel{(c)}{\leq} \frac{1}{12}, \quad (30)$$

where (a), (b) holds with equality for $p \rightarrow \infty$; (c) holds with equality if $p = 1$.

Note that in [23, equation (82)], there is also an upper bound on G_p due to Zador. The bound is the following:

$$G_p \leq \frac{1}{p\pi} \Gamma\left(\frac{p}{2} + 1\right)^{\frac{2}{p}} \Gamma\left(1 + \frac{2}{p}\right). \quad (31)$$

In Fig. 4 we illustrate two plots where we compute the bounds derived in Theorems 3, 4 for two different scenarios. In Fig. 4, (a), we choose $t = \{1, \dots, 20\}$, $a_t \in (0, 1.5)$, $\sigma_{w_t}^2 = 1$, and $D = 1$, to illustrate the gap between the time-varying rate-distortion allocation obtained using the lower bound (24) and the upper bound (28) when the latter is approximated with the best known quantizer up to twenty four dimensions that is a lattice known as Leech lattice quantizer (for details see, e.g., [23, Table 2.3]). For this experiment the gap between the two bounds is approximately 0.126 bits/dimension. In Fig. 4, (b), we perform another experiment assuming the same values for $(a_t, \sigma_{w_t}^2, D)$, whereas the quantization is performed for 500 dimensions. We observe that the achievable bounds obtained via (29) and (31) are quite tight (they have a gap of approximately 0.0014 bits/dimension) whereas the gap between the lower bound (24) with the achievable upper bound (28) approximated by (29) is 0.0097 bits/dimension, and the one approximated by (31) is approximately 0.011 bits/dimension. Thus, compared to the first experiment where $p = 24$, the gap between the bounds on the minimum achievable rate R_t^{ECDQ} is considerably decreased because we increased the number of dimensions in the system. Clearly, when the number of dimensions in the system increase, the gap between (24) and the high dimensional approximations of (28) will become arbitrary small. The two bounds will coincide in the asymptotic limit, due to the asymptotic optimality of the ECDQ-based DPCM predictive coding scheme (see [22, Chapter 5]) and also because in the limit, (29) is equal to (31) (see, e.g., [23, equation (83)]).

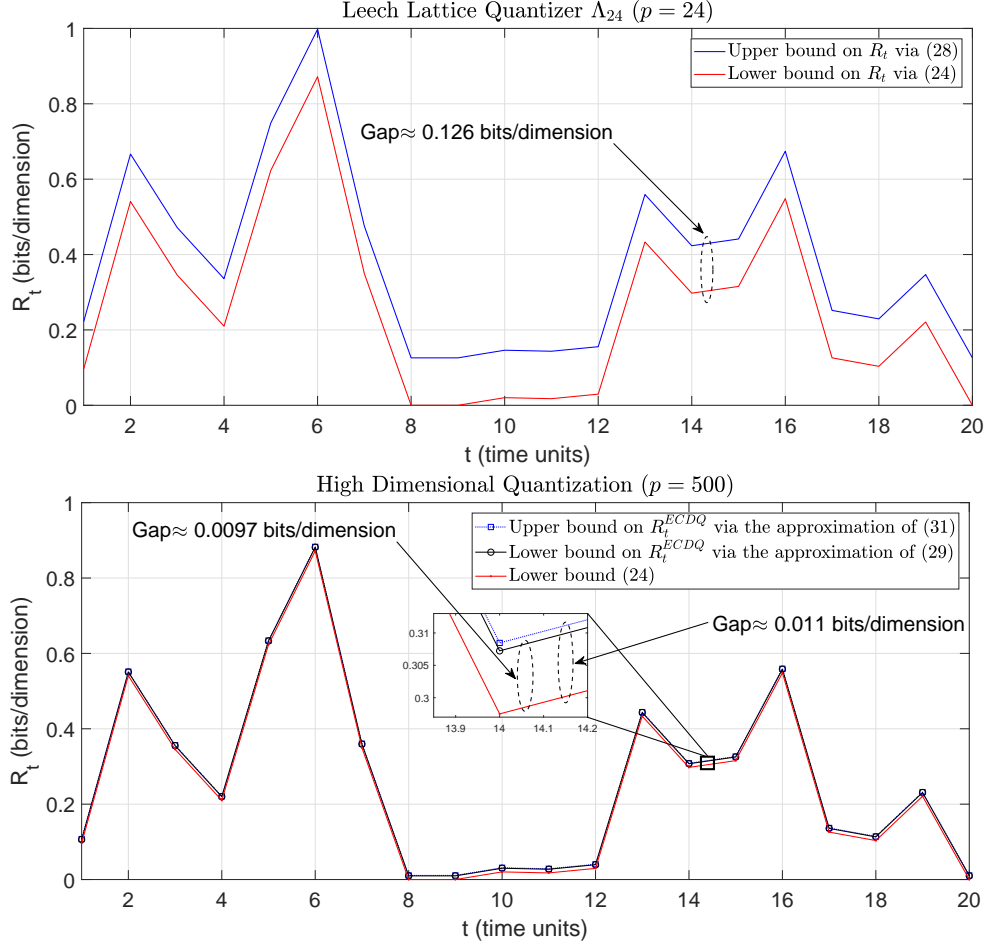

Fig. 4: Bounds on the minimum achievable rate obtained using pre-post filtered ECDQ-based DPCM.

V. APPLICATION IN NCSS

In this section, we demonstrate the sequential coding framework in the NCS setup of Fig. 5 by applying the results obtained in §IV.

Plant. Consider p parallel time-varying controlled Gauss-Markov processes as follows:

$$x_{t+1}(i) = \alpha_t x_t(i) + \beta_t u_t(i) + w_t(i), \quad i \in \mathbb{N}_1^p, \quad t \in \mathbb{N}_1^n, \quad (32)$$

where $x_1(i) \equiv x_1$ is given with $x_1 \sim \mathcal{N}(0; \sigma_{x_1}^2)$, $\forall i$; the non-random coefficients $(\alpha_t, \beta_t) \in \mathbb{R}$ are known to the system with $(\alpha_t, \beta_t) \neq 0$, $\forall t$; $\{u_t(i) : i \in \mathbb{N}_1^p\}$ is the controlled process with $u_t(i) \neq u_t(\ell)$, for any $(i, \ell) \in \mathbb{N}_1^p$; $\{w_t(i) \equiv w_t : i \in \mathbb{N}_1^p\}$ is an independent Gaussian noise process such that $w_t \sim \mathcal{N}(0; \sigma_{w_t}^2)$, $\sigma_{w_t}^2 > 0$, independent of x_1 , $\forall i$. Again, similar to §IV, (32)

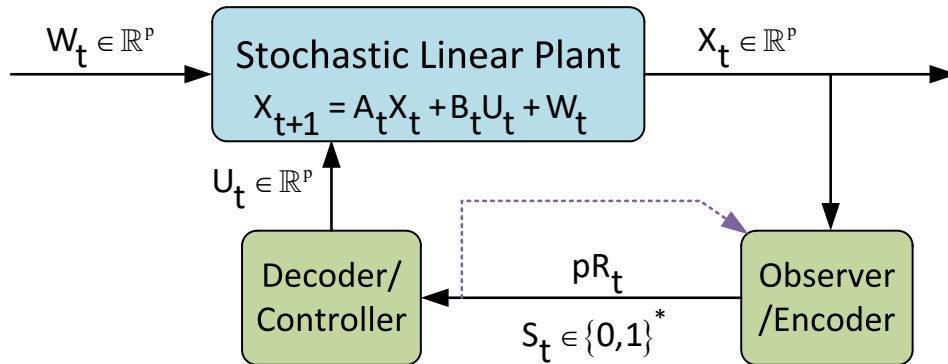

Fig. 5: Controlled system model.

can be compactly written as follows

$$X_{t+1} = A_t X_t + B_t U_t + W_t, \quad X_1 = \text{given}, \quad t \in \mathbb{N}_1^n, \quad (33)$$

where $A_t = \text{diag}(\alpha_t, \dots, \alpha_t) \in \mathbb{R}^{p \times p}$, $B_t = \text{diag}(\beta_t, \dots, \beta_t) \in \mathbb{R}^{p \times p}$, $U_t \in \mathbb{R}^p$, $W_t \in \mathbb{R}^p \sim \mathcal{N}(0; \Sigma_{W_t})$, $\Sigma_{W_t} = \text{diag}(\sigma_{w_t}^2, \dots, \sigma_{w_t}^2) \succ 0$ is an independent Gaussian noise process independent of X_1 . Note that in this setup, the plant is fully observable for the observer (encoder) that acts as an encoder but not for the controller due to the quantization noise (coding noise).

Observer/Encoder. At the encoder the controlled process is collected into a frame $X_t \in \mathbb{R}^p$ from the plant and encoded as follows:

$$S_t = f_t(X_{1,t}, S_{1,t-1}), \quad (34)$$

where at $t = 1$ we have $S_1 = f_1(X_1)$, and $R_t = \frac{\mathbb{E}|S_t|}{p}$ is the rate at each time instant t available for transmission via the noiseless channel. Note that in the design of Fig. 5, the channel is noiseless, and the controller/decoder are deterministic mappings, thus, the observer/encoder implicitly has access to earlier control signals $U_{1,t-1} \in \mathbb{U}_{1,t-1}$.

Decoder/Controller. The data packet S_t is received by the controller using the following reconstructed sequence:

$$U_t = g_t(S_{1,t}). \quad (35)$$

According to (35), when the sequence $S_{1,t}$ is available at the decoder/controller, all past control

signals $U_{1,t-1}$ are completely specified.

Quadratic cost. The cost of control (per dimension) is defined as

$$\text{LQG}_{1,n} \triangleq \frac{1}{p} \mathbf{E} \left\{ \sum_{t=1}^{n-1} \left(X_t^\top \tilde{Q}_t X_t + U_t^\top \tilde{N}_t U_t \right) + X_n^\top \tilde{Q}_n X_n \right\}, \quad (36)$$

where $\tilde{Q}_t = \text{diag}(Q_t, \dots, Q_t) \succeq 0$, $\tilde{Q}_t \in \mathbb{R}^{p \times p}$ and $\tilde{N}_t = \text{diag}(N_t, \dots, N_t) \succ 0$, $\tilde{N}_t \in \mathbb{R}^{p \times p}$, are designing parameters that penalize the state variables or the control signals.

Performance. The performance of Fig. 5 (per dimension) can be cast to a finite-time horizon quantized LQG control problem subject to all communication constraints as follows:

$$J(R) = \min_{\substack{(f_t, g_t): t=1, \dots, n \\ \frac{1}{n} \sum_{t=1}^n R_t \leq R}} \text{LQG}_{1,n}. \quad (37)$$

Iterative Encoder/Controller Design: In general, as (37) suggests, the optimal performance of the system in Fig. 5 is achieved only when the encoder/controller pair is designed jointly. This is a quite challenging task especially when the channel is noisy because information structure is non-nested in such cases (for details see, e.g., [33]). There are examples, however, where the separation principle applies and the task comes much easier. More precisely, the so-called certainty equivalent controller remains optimal if the estimation errors are independent of previous control commands (i.e., dual effect is absent) [34]. In our case, the optimal control strategy will be a certainty equivalence controller *only if we assume a fixed and given sequence of encoders* $\{f_t : t \in \mathbb{N}_1^n\}$ (see, e.g., [35, Proposition 3], [36], [37, §III]). Moreover, the separation principle will also be optimal if we consider a MMSE estimate of the state (similar to what we have established in §IV), and an encoder that minimizes a distortion for state estimation at the controller. The resulting separation principle is termed “weak separation principle” [36] as it relies on the fixed and given quantization policies. This is different from the well-known full separation principle in the classical LQG stochastic control problem [38] where the problem separates naturally into a state estimator and a state feedback controller without any loss of optimality.

Next, we give the weak separation principle that corresponds to Fig. 5 in the form of a lemma that was first derived in [36], [39] for the more general setting of correlated vector-valued controlled Gauss-Markov processes with linear quadratic cost.

Lemma 3. (*Weak separation principle for Fig. 5*)

The optimal controller that minimizes (37) is given by

$$U_t = -L_t \mathbf{E} \{X_t | S_{1,t}\}, \quad (38)$$

where $\mathbf{E} \{X_t | S_{1,t}\}$ are the fixed quantized state estimates obtained from the estimation problem in §IV; $\tilde{L}_t = \text{diag}(L_t, \dots, L_t) \in \mathbb{R}^p$ is the optimal LQG control (feedback) gain obtained as follows:

$$\tilde{L}_t = \left(B_t^2 \tilde{K}_{t+1} + \tilde{N}_t \right)^{-1} B_t \tilde{K}_{t+1} A_t, \quad (39)$$

and $\tilde{K}_t = \text{diag}(K_t, \dots, K_t) \succeq 0$ is obtained using the backward recursions:

$$\tilde{K}_t = A_t^2 \left(\tilde{K}_{t+1} - \tilde{K}_{t+1} B_t^2 (B_t^2 \tilde{K}_{t+1} + \tilde{N}_t)^{-1} \tilde{K}_{t+1} \right) + \tilde{Q}_t, \quad (40)$$

with $\tilde{K}_{n+1} = 0$. Moreover, this controller achieves a minimum linear quadratic cost of

$$J(R) = \frac{1}{p} \sum_{t=1}^n \left\{ \text{trace}(\Sigma_{W_t} \tilde{K}_t) + \text{trace}(A_t B_t \tilde{L}_t \tilde{K}_{t+1} \mathbf{E}\{\|X_t - Y_t\|_2^2\}) \right\}, \quad (41)$$

where $\mathbf{E}\{\|X_t - Y_t\|_2^2\}$ is the MMSE distortion obtained using any quantization (coding) in the control/estimation system.

Before we prove our main theorem, we define the instantaneous cost of control as follows:

$$\text{LQG}_t \triangleq \frac{1}{p} \left\{ \text{trace}(\Sigma_{W_t} \tilde{K}_t) + \text{trace}(A_t B_t \tilde{L}_t \tilde{K}_{t+1} \mathbf{E}\{\|X_t - Y_t\|_2^2\}) \right\}, \quad t \in \mathbb{N}_1^n. \quad (42)$$

Next, we prove the following theorem.

Theorem 5. (Non-asymptotic performance for Fig. 5)

(1) For the NCS of Fig. 5, the minimum total-cost of control (per dimension) for any “ n ” and any p , however large, is $J(R) = \sum_{t=1}^n \text{LQG}_t$, with $\text{LQG}_t \geq \text{LQG}_t^*$ such that

$$\text{LQG}_t^* = \sigma_{w_t}^2 K_t + \alpha_t \beta_t L_t K_{t+1} D(R_t^*), \quad (43)$$

where $D_t(R_t^*)$ is given by:

$$D(R_t^*) \triangleq \begin{cases} \frac{\sigma_{w_t}^2}{2^{2R_t^*} - \alpha_t^2}, & \forall t \in \mathbb{N}_1^{n-1} \\ 2^{-2R_n^*}, & \text{for } t = n \end{cases}, \quad (44)$$

with the pair $(D(R_t^*), R_t^*)$ given by (24)-(26).

(2) If we consider a DPCM predictive coding scheme with a MMSE \mathbb{R}^p -valued quantizer in (41) that “simulates” precisely the Gaussian test-channel distribution corresponding to R_t^* , $\forall t$, then, for any “ n ” the minimum achievable total-cost of control for the NCS in Fig. 5 is given by $J(R) = \sum_{t=1}^n \text{LQG}_t$ such that $\text{LQG}_t = \text{LQG}_t^*$. Hence,

$$J(R) = \sum_{t=1}^n \sigma_{w_t}^2 K_t + \alpha_t \beta_t L_t K_{t+1} D(R_t^*), \quad (45)$$

with $K_{n+1} = 0$ and all the statements in (1) to hold.

Proof. See Appendix E. □

Next, we use Theorem 4 to find an upper bound on $J(R)$.

Theorem 6. (Upper bound on $J(R)$)

Suppose that in (41) we apply a sequential causal ECDQ-based DPCM predictive coding scheme with an \mathbb{R}^p -valued lattice quantizer. Then, $J(R) = \sum_{t=1}^n \text{LQG}_t$ for any n , and any p , with the instantaneous cost of control $\{\text{LQG}_t : t \in \mathbb{N}_1^{n-1}\}$ (per dimension) to be upper bounded as follows:

$$\text{LQG}_t \leq \sigma_{w_t}^2 K_t + \alpha_t \beta_t L_t K_{t+1} \frac{4^{\frac{1}{p}} (2\pi e G_p) \sigma_{w_t}^2}{2^{2R_t^{\text{ECDQ}}} - 4^{\frac{1}{p}} (2\pi e G_p) \alpha_t^2}, \quad (46)$$

whereas, at $t = n$, $\text{LQG}_n = \sigma_{w_n}^2 K_n$ and R_t^{ECDQ} is bounded above as in (28).

Proof. Note that from Lemma 3, (41), we obtain:

$$\begin{aligned} J(R) &= \frac{1}{p} \sum_{t=1}^n \left\{ \text{trace}(\Sigma_{W_t} \tilde{K}_t) + \text{trace}(A_t B_t \tilde{L}_t \tilde{K}_{t+1} \mathbf{E}\{\|X_t - Y_t\|_2^2\}) \right\} \\ &= \frac{1}{p} \sum_{t=1}^n \left\{ \text{trace}(\Sigma_{W_t} \tilde{K}_t) + \text{trace}(A_t B_t \tilde{L}_t \tilde{K}_{t+1} D(R_t^{\text{ECDQ}})) \right\} \\ &\stackrel{(a)}{\leq} \sum_{t=1}^{n-1} \left\{ \sigma_{w_t}^2 K_t + \alpha_t \beta_t L_t K_{t+1} \frac{4^{\frac{1}{p}} (2\pi e G_p) \sigma_{w_t}^2}{2^{2R_t^{\text{ECDQ}}} - 4^{\frac{1}{p}} (2\pi e G_p) \alpha_t^2} \right\} + \sigma_{w_n}^2 K_n, \end{aligned} \quad (47)$$

where (a) follows by first reformulating $\{R_t^* : t \in \mathbb{N}_1^n\}$ similar to (60) (in the derivation of Theorem 5) so that we decouple the dependence on D_{t-1} . Then, we solve the inequality obtained

in Theorem 4, (28) with respect to $D(R_t^{\text{ECDQ}})$ which gives

$$D(R_t^{\text{ECDQ}}) \leq \frac{4^{\frac{1}{p}}(2\pi e G_p)\sigma_w^2}{2^{2R_t^{\text{ECDQ}}} - 4^{\frac{1}{p}}(2\pi e G_p)\alpha_t^2}, \quad t \in \mathbb{N}_1^{n-1}. \quad (48)$$

Observe that the last step $t = n$ is trivial because in (41) we have $\tilde{K}_{n+1} = 0$. This completes the proof. \square

Note that for Theorems 5, 6 we can remark the following.

Remark 5. (Comments on Theorems 5, 6)

(1) The upper bound in (46) becomes equal to the lower bound in Theorem 5, (1), if $p \rightarrow \infty$ because the infinite dimensional lattice quantizer has $G_\infty = \frac{1}{2\pi e}$ (see [22, Chapter 5]).

(2) The upper bound in (46) is different compared to the existing upper bounds in [40]–[42] obtained using ECDQ coding schemes with noiseless feedback links. Specifically, [40]–[42] consider schemes operating at infinite-time horizon whereas here we propose sequential coding which facilitates the computation of upper bounds in finite-time horizon. Moreover, those papers used scalar quantization to obtain their bounds whereas here we leverage vector quantization in the spatial dimension “ p ” which further improves the systems’ performance. Finally, in [40, Eq. (25)] (see also [41]), [42, Eq. (4)] the authors seek the minimum rates subject to a cost which is constrained by some scalar constant. Here, we consider the inverse problem, i.e., we minimize the LQG control cost when the total-rates are constrained by some constant R (see (37)).

(3) The bounds in Theorems 5, 6 reveal necessary conditions to stabilize the non-asymptotic cost of control, when $|a_t| > 1$, i.e., the parallel time-varying Gauss-Markov processes in (32) are unstable. Specifically, from (43) we ensure $\text{LQG}_t^* < \infty$ only if $R_t^* > \log_2 |\alpha_t|$. Similarly, from (46), we ensure $\text{LQG}_t^{\text{ECDQ}} < \infty$ only if $R_t^{\text{ECDQ}} > \log_2 |\alpha_t| + \frac{1}{2} \log_2 \left(4^{\frac{1}{p}}(2\pi e G_p) \right)$, $\forall t \in \mathbb{N}_1^{n-1}$.

Asymptotic limit: If in (43), (46) we let $t \rightarrow \infty$, and assume that $\alpha_t \equiv \alpha$, $\beta_t \equiv \beta$, $\sigma_{w_t}^2 \equiv \sigma_w^2$, $L_t \equiv L$, $K_t \equiv K$, $R_t^* \equiv R^*$, $R_t^{\text{ECDQ}} \equiv R^{\text{ECDQ}}$, then, we obtain

$$\text{LQG}_\infty \geq \text{LQG}_\infty^* = \sigma_w^2 K + \alpha \beta L K \frac{\sigma_w^2}{2^{2R^*} - \alpha^2}, \quad (49)$$

$$\text{LQG}_\infty \leq \sigma_w^2 K + \alpha \beta L K \frac{4^{\frac{1}{p}}(2\pi e G_p)\sigma_w^2}{2^{2R^{\text{ECDQ}}} - 4^{\frac{1}{p}}(2\pi e G_p)\alpha^2}. \quad (50)$$

The lower bound of (49) (per dimension) is well-known (see, e.g., [39]). The upper bound of (50) is new and has never been documented elsewhere. If $p = 1$, then (50) gives as a special case [17, Corollary 8].

VI. CONCLUSIONS AND FUTURE DIRECTIONS

We revisited the problem of sequential coding for correlated sources and demonstrated its utility via application examples in identifying fundamental performance limitations and stability conditions of stochastic dynamical systems on finite-time horizon. As application examples, we considered a parallel time-varying quantized state-estimation problem subject to a MSE distortion constraint and a parallel time-varying quantized LQG closed-loop control system with quadratic cost.

Our future research will focus in extending the current framework to higher-order Gauss-Markov processes with MSE distortion constraints, and to provide performance limitations for NCSs under privacy constraints. For the latter, we will investigate simple networks where the systems' communication is intercepted by an eavesdropper who wishes to steal information from a legitimate user. The goal in such cases, is usually to impair the eavesdroppers performance compared to the legitimate user who wishes to acquire information as reliably as possible (see, for instance, [43]).

APPENDIX A

PROOF OF THEOREM 1

First, observe that for any point $(R_{1,n}, D_{1,n}) \in \mathcal{R}^{\text{IID,op},m}$ there exist auxiliary RVs and deterministic functions that satisfy the constraint set of the rate-distortion region in (12). Choose

a fixed positive integer $m \in \{1, \dots, t\}$, $t \in \mathbb{N}_1^n$. Then, we obtain

$$\begin{aligned}
\mathcal{R}_{\text{sum}}^{\text{IID,op},m}(D_{1,n}) &\equiv \sum_{t=1}^n R_t \\
&\geq I(X_1; S_1) + \dots + I(X_{n+1-m,n}; Y_n | S_{1,n-1}) \\
&\stackrel{(a)}{=} I(X_{1,n}; S_{1,n-1}, Y_n) \\
&\stackrel{(b)}{=} I(X_{1,n}; S_{1,n-1}, Y_{1,n}) \\
&\geq I(X_{1,n}; Y_{1,n}) \\
&\geq \min_{\text{the constraints in (14) hold}} I(X_{1,n}; Y_{1,n}) = R_{\text{sum}}^{\text{IID},m}(D_{1,n}),
\end{aligned} \tag{51}$$

where (a) stems from the fact that the conditional independence constraints in (12) hold; (b) stems from the fact that $Y_{1,t-1} = g(S_{1,t-1})$, $\forall t$. Note that $I(X_{1,n}; Y_{1,n}) = \sum_{t=1}^n I(X_{t+1-m,t}; Y_t | Y_{1,t-1})$ because the conditional independence constraints in (14) are satisfied. Thus, a lower bound to the minimum achievable total-rate is obtained.

Now, because a possible realization of the encoded symbols is always $\{S_t = Y_t : \forall t \in \mathbb{N}_1^{n-1}\}$, we obtain

$$\begin{aligned}
\sum_{t=0}^n R_t &= \min_{\text{the constraints of (12) hold}} I(X_{1,n}; Y_n, S_{1,n-1}) \\
&\leq \min_{\text{the constraints in (14) hold}} I(X_{1,n}; Y_{1,n}) = \mathcal{R}_{\text{sum}}^{\text{IID},m}(D_{1,n}).
\end{aligned} \tag{52}$$

This completes the proof. ■

APPENDIX B

PROOF OF THEOREM 2

First observe that in Lemma 1 we can take

$$F(D_1, \dots, D_n) = \{R_1, \dots, R_n \mid \text{expressions of (8) hold}\}.$$

Then, the minimum achievable total-rate subject to a total average distortion constraint can be formulated as follows.

$$\begin{aligned}
\mathcal{R}_{\text{sum}}^{\text{IID,op}}(D) &= \min_{(R_1, \dots, R_n) \in \{F(D_1, \dots, D_n) \text{ s. t. } \frac{1}{n} \sum_{t=1}^n D_t \leq D\}} \sum_{t=1}^n R_t \\
&= \min_{(D_1, \dots, D_n): \frac{1}{n} \sum_{t=1}^n D_t \leq D} \min_{R_t \in F(D_1, \dots, D_n), \forall t} \sum_{t=1}^n R_t \\
&= \min_{(D_1, \dots, D_n): \frac{1}{n} \sum_{t=1}^n D_t \leq D} \min_{R_t \in F(D_1, \dots, D_n), \forall t} \sum_{t=1}^n R_t \tag{53} \\
&\stackrel{(a)}{\geq} \min_{\substack{(D_1, \dots, D_n): \\ \frac{1}{n} \sum_{t=1}^n D_t \leq D}} \min_{\substack{\mathbf{E}\{d_t(X_t, Y_t)\} \leq D_t \\ Y_1 \leftrightarrow (X_1) \leftrightarrow X_{2,n}, \\ Y_t \leftrightarrow (X_{1,t}, Y_{1,t-1}) \leftrightarrow X_{t+1,n}, \forall t}} I(X_{1,n}; Y_{1,n}) \\
&= \text{right hand side (RHS) of (15),}
\end{aligned}$$

where (a) follows from Theorem 1. This completes the proof. \blacksquare

APPENDIX C

PROOF OF THEOREM 3

(1) *Lower Bound (Converse)*. Since the source is modeled as a first-order Gauss-Markov process, then, utilizing Theorems 1, 2 in (23) we obtain:

$$\begin{aligned}
\mathcal{R}_{\text{sum}}^{\text{IID,op,1}}(D) &\stackrel{(a)}{\geq} \mathcal{R}_{\text{sum}}^{\text{IID,1}}(D), \\
&= \min_{\substack{\frac{1}{n} \sum_{t=1}^n \mathbf{E}\{\|X_t - Y_t\|_2^2\} \leq D, \\ Y_1 \leftrightarrow X_1 \leftrightarrow X_{2,n}, \\ Y_t \leftrightarrow (X_t, Y_{1,t-1}) \leftrightarrow (X_{1,t-1}, X_{t+1,n})}} \frac{1}{p} \sum_{t=1}^n I(X_t; Y_t | Y_{1,t-1}), \tag{54}
\end{aligned}$$

where (a) hold with equality if and only if $Y_t = S_t, \forall t \in \mathbb{N}_1^n$, or equivalently, if and only if the Gaussian minimizing distribution is precisely achieved by an ideal quantizer (see the discussion in Remark 2). By Proposition 2, the RHS term in (54) corresponds precisely to the NRDF obtained for parallel Gauss-Markov processes with a total MSE distortion constraint which is a simple generalization of the scalar-valued problem that has already been studied in

[30]. Therefore, using the analysis of [30] we can obtain:

$$\begin{aligned}
\mathcal{R}_{\text{sum}}^{\text{IID},1}(D) &\stackrel{(b)}{=} \min_{\text{constraint in (54)}} \frac{1}{p} \sum_{t=1}^n \{h(X_t|Y_{1,t-1}) - h(X_t|Y_{1,t})\} \\
&\stackrel{(c)}{=} \frac{1}{p} \min_{\substack{D_t \geq 0, t \in \mathbb{N}_1^n \\ \frac{1}{n} \sum_{t=1}^n D_t \leq D}} \sum_{t=1}^n \max \left[0, \frac{1}{2} \log_2 \left(\frac{|\Lambda_t|}{|\Delta_t|} \right) \right], \\
&= \min_{\substack{D_t \geq 0, t \in \mathbb{N}_1^n \\ \frac{1}{n} \sum_{t=1}^n D_t \leq D}} \sum_{t=1}^n \max \left[0, \frac{1}{2} \log_2 \left(\frac{\lambda_t}{D_t} \right) \right], \tag{55}
\end{aligned}$$

where (b) follows by definition; (c) follows from the fact that $h(X_t|Y_{1,t-1}) = \frac{1}{2} \log_2(2\pi e)^p |\Lambda_t|$ where $\Lambda_t = \text{diag}(\lambda_t, \dots, \lambda_t) \in \mathbb{R}^{p \times p}$ with $\lambda_t = \alpha_{t-1}^2 D_{t-1} + \sigma_{w_{t-1}}^2$, and that $h(X_t|Y_{1,t}) = \frac{1}{2} \log_2(2\pi e)^p |\Delta_t|$ where $\Delta_t = \text{diag}(D_t, \dots, D_t) \in \mathbb{R}^{p \times p}$ for $D \in [0, \infty)$. The optimization problem of (55) is already solved in [30, Theorem 2] and is given by (24)-(26).

(2) This can be proved by generalizing [13, Corollary 1.2] to any n and using the result of [13, Corollary 1.3]. This idea is also explained in Remark 2. Observe that because the state is modeled as a first-order Gauss-Markov process, the sequential causal coding is precisely equivalent to predictive coding (see, e.g., [15, Theorem 3]). Therefore, we can immediately apply the standard sequential causal DPCM¹ [18], [44] approach (with \mathbb{R}^p -valued MMSE quantizers) to obtain for any “ n ” and sufficiently large p an achievable R_t such that $R_t \geq R_t^*$. This can be described for each time instant t as follows. At the *encoder or innovations’ encoder* we perform the linear operation $\hat{X}_t = X_t - A_{t-1}Y_{t-1}$, $Y_{t-1} \triangleq \mathbf{E}\{X_{t-1}|S_{1,t-1}\}$, with $\hat{X}_1 = X_1$, which is a sufficient statistic of the quantized symbols $S_{1,t}$. Then, by means of a \mathbb{R}^p -valued MMSE quantizer that operates at a random rate R_t , we generate the quantized reconstruction of the residual source denoted by \hat{Y}_t . At the *decoder* we receive the quantized symbol \hat{Y}_t of \hat{X}_t . Then, we generate the estimate Y_t using the linear operation $Y_t = \hat{Y}_t + A_{t-1}Y_{t-1}$. A pictorial view of the previous quantization scheme is given in Fig. 6. The performance of this quantization scheme is measured as follows:

$$\Delta_t^{\text{DPCM}} = \mathbf{E}\{e_t e_t^T\}, \quad e_t = X_t - Y_t = \hat{X}_t - \hat{Y}_t, \tag{56}$$

¹The goal of DPCM is to translate the encoding of temporally correlated source samples into a series of independent encodings. This is done using linear prediction, i.e., at each time instant the incoming source sample is predicted from previously encoded samples, creating a prediction error which in turn is encoded by a quantizer and added to the predicted value to form the new reconstruction.

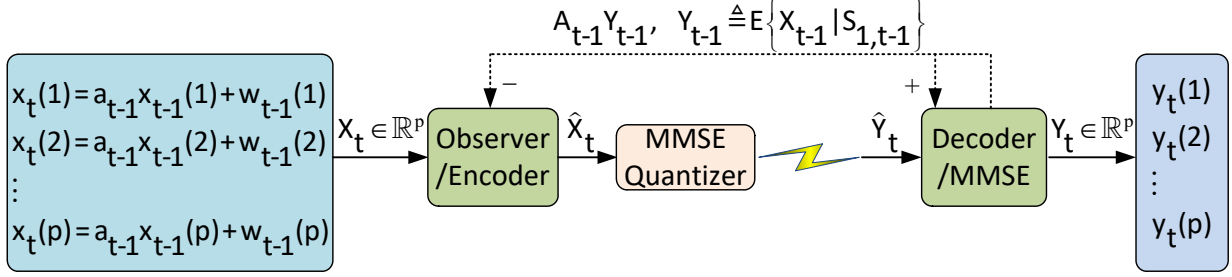

Fig. 6: DPCM of parallel processes.

where $\Delta_t^{\text{DPCM}} = \text{diag}(D_t^{\text{DPCM}}, \dots, D_t^{\text{DPCM}})$. In order to show the existence of some achievable rates, we need to find the covariance of the quantized innovations' source symbols. Since the Gaussian noise process $W_t \sim \mathcal{N}(0; \Sigma_{W_t})$ is independent of the error process e_t , $\forall t \in \mathbb{N}_1^n$, we can obtain:

$$\Lambda_t^{\text{DPCM}} = \mathbf{E} \left\{ \|\hat{X}_t\|_2^2 \right\} = A_{t-1} \Delta_{t-1}^{\text{DPCM}} + \Sigma_{W_{t-1}}, \quad (57)$$

$\Lambda_t^{\text{DPCM}} = \text{diag}(\lambda_t^{\text{DPCM}}, \dots, \lambda_t^{\text{DPCM}})$, where $\lambda_t^{\text{DPCM}} = \alpha_{t-1}^2 D_{t-1}^{\text{DPCM}} + \sigma_{w_t}^2$, for any n and any p . Observe that the DPCM predictive coding scheme at each time instant t presupposes that the non-Gaussian process $\{\hat{X}_t : t \in \mathbb{N}_1^n\}$, is an independent process with zero-mean and covariance Λ_t^{DPCM} . Then, the instantaneous achievable rates (per dimension) can be obtained as follows:

$$R_t^* \stackrel{(a)}{\leq} R_t^{\text{DPCM}} = \frac{1}{2} \log_2 \left(\frac{\lambda_t^{\text{DPCM}}}{D_t^{\text{DPCM}}} \right), \quad (58)$$

where (a) holds with equality if and only if the MMSE \mathbb{R}^p -valued quantizer is ideal in the sense that it “simulates” the corresponding Gaussian “test-channel” distribution obtained for R_t^* for any $t \in \mathbb{N}_1^n$.

This completes the proof. ■

APPENDIX D

PROOF OF THEOREM 4

This is immediate, if in the realization scheme of DPCM predictive coding scheme of Theorem 3, (2), we apply an ECDQ which results into the realization of Fig. 7. In this realization, the pre/post filtered ECDQ coding scheme (see, e.g., [22, Chapter 5.6.2, Fig. 5.5] is such that in each dimension the pre/post scaled coefficients $a = b = \sqrt{1 - \frac{D_t}{\lambda_t}}$ to ensure that the end-to-end realization operates at a distortion level D_t (normalized per dimension) with a total distortion

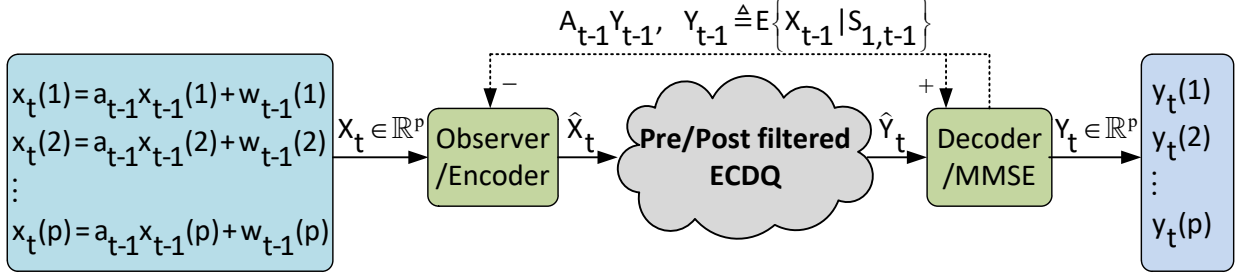

Fig. 7: Sequential ECDQ-based DPCM predictive coding scheme for parallel sources.

$D = \frac{1}{n} \sum_{t=1}^n D_t$. This scheme guarantees a performance with a rate-loss of $\frac{1}{2} \log_2(2\pi e G_p)$ bits/dimension from the minimum achievable rates R_t^{ECDQ} at each instant t due to the “space-filling loss” of the lattice quantizer (see [22, Theorem 5.6.1]). The additional rate-loss $\frac{1}{p}$ in (28) follows because in pre/post filtered ECDQ coding scheme, we have entropy coders which herein we assume to operate using prefix-free codes that cause an additional rate-loss of at most $\frac{1}{p}$ [45, Chapter 5]. This completes the proof. ■

APPENDIX E

PROOF OF THEOREM 5

(1) *Lower Bound.* Note that from (41) we obtain

$$\begin{aligned}
 J(R) &= \sum_{t=1}^n \text{LQG}_t \\
 &= \frac{1}{p} \sum_{t=1}^n \left\{ \text{trace}(\Sigma_{W_t} \tilde{K}_t) + \text{trace}(A_t B_t \tilde{L}_t \tilde{K}_{t+1} \mathbf{E}\{\|X_t - Y_t\|_2^2\}) \right\} \\
 &\stackrel{(a)}{\geq} \frac{1}{p} \sum_{t=1}^n \left\{ \text{trace}(\Sigma_{W_t} \tilde{K}_t) + \text{trace}(A_t B_t \tilde{L}_t \tilde{K}_{t+1} \mathbf{E}\{\|X_t - \mathbf{E}\{X_t | S_{1,t}\}\|_2^2\}) \right\} \\
 &\stackrel{(b)}{\geq} \frac{1}{p} \sum_{t=1}^n \left\{ \text{trace}(\Sigma_{W_t} \tilde{K}_t) + \text{trace} \left(A_t B_t \tilde{L}_t \tilde{K}_{t+1} \mathbf{E}_{\bar{S}_{1,t-1}} \left\{ \frac{1}{2\pi e} 2^{\frac{2}{p} h(X_t | S_{1,t-1} = \bar{S}_{1,t-1})} \right\} 2^{-2R_t^*} \right) \right\}, \\
 &\stackrel{(c)}{\geq} \frac{1}{p} \sum_{t=1}^n \left\{ \text{trace}(\Sigma_{W_t} \tilde{K}_t) + \text{trace} \left(A_t B_t \tilde{L}_t \tilde{K}_{t+1} \left\{ \frac{1}{2\pi e} 2^{\frac{2}{p} h(X_t | S_{1,t-1})} 2^{-2R_t^*} \right\} \right) \right\}, \\
 &\stackrel{(d)}{\geq} \sum_{t=1}^n \left\{ \sigma_{w_t}^2 K_t + \alpha_t \beta_t L_t K_{t+1} D(R_t^*) \right\} \triangleq \sum_{t=1}^n \text{LQG}_t^*,
 \end{aligned} \tag{59}$$

where (a) follows from the fact that Y_t is $\mathbb{S}_{1,t}$ -measurable and the MMSE is obtained for $Y_t = \mathbf{E}\{X_t|S_{1,t}\}$; (b) follows from the fact that $\mathbf{E}\{\|X_t - \mathbf{E}\{X_t|S_{1,t}\}\|_2^2\} = \mathbf{E}_{\bar{S}_{1,t-1}}\{\mathbf{E}\{\|X_t - \mathbf{E}\{X_t|S_{1,t}\}\|_2^2|S_{1,t-1} = \bar{S}_{1,t-1}\}\}$, where $\mathbf{E}_{\bar{S}_{1,t}}\{\cdot\}$ is the expectation with respect to some vector $\bar{S}_{1,t-1}$ that is distributed similarly to $S_{1,t-1}$, also from the MSE inequality in [45, Theorem 17.3.2] and finally from the fact that $R_t^* \geq 0$, where $R_t^* = \frac{1}{p}\{h^*(X_t|Y_{1,t-1}) - h^*(X_t|Y_{1,t})\}$ (see the derivation of Theorem 3, (1)) with $h^*(X_t|Y_{1,t-1})$, $h^*(X_t|Y_{1,t})$ being the minimized values in (55); (c) follows from Jensen's inequality [45, Theorem 2.6.2], i.e., $\mathbf{E}_{\bar{S}_{1,t-1}}\left\{2^{\frac{2}{p}h(X_t|S_{1,t-1}=\bar{S}_{1,t-1})}\right\} \geq 2^{\frac{2}{p}h(X_t|S_{1,t-1})}$; (d) follows from the fact that $\{h(X_t|S_{1,t-1}) = h(A_{t-1}X_{t-1} + B_{t-1}U_{t-1} + W_{t-1}|S_{1,t-1}) : t \in \mathbb{N}_2^n\}$ is completely specified from the independent Gaussian noise process $\{W_{t-1} : t \in \mathbb{N}_2^n\}$ because $\{U_{t-1} = g_t(S_{1,t-1}) : t \in \mathbb{N}_2^n\}$ (see (35)) are constants conditioned on $S_{1,t-1}$. Therefore, $h(X_t|S_{1,t-1})$ is conditionally Gaussian thus equivalent to $h(X_t|Y_{t-1})$. This further means that $\frac{1}{2\pi e}2^{\frac{2}{p}h(X_t|Y_{1,t-1})}2^{-2R_t^*} \geq \frac{1}{2\pi e}2^{\frac{2}{p}h^*(X_t|Y_{1,t-1})}2^{-2R_t^*} \stackrel{(\star)}{=} \frac{1}{2\pi e}2^{\frac{1}{p}\log_2(2\pi e)^p|\Delta_t^*|} \stackrel{(\star\star)}{=} \min\{D_t\} \equiv D(R_t^*)$, where (\star) follows because $h^*(X_t|Y_{1,t}) = \frac{1}{2}\log_2(2\pi e)^p|\Delta_t^*|$ and $(\star\star)$ follows because $\Delta_t^* = \text{diag}(\min\{D_t\}, \dots, \min\{D_t\})$.

It remains to find $D(R_t^*)$ at each time instant in (59). To do so, we reformulate the solution of the dynamic reverse-waterfilling solution in (24) as follows:

$$\begin{aligned} \mathcal{R}_{\text{sum}}^{\text{IID},1} &= \sum_{t=1}^n R_t^* \equiv \frac{1}{2} \sum_{t=1}^n \log_2 \left(\frac{\lambda_t}{D_t} \right) \\ &= \frac{1}{2} \left\{ \underbrace{\log_2(\lambda_1)}_{\text{initial step}} \xrightarrow{0} + \sum_{t=1}^{n-1} \log_2 \left(\alpha_t^2 + \frac{\sigma_{w_t}^2}{D_t} \right) - \underbrace{\log_2 D_n}_{\text{final step}} \right\}. \end{aligned} \quad (60)$$

From (60) we observe that at each time instant, the rate R_t^* is a function of only one distortion D_t since we have now decoupled the correlation with D_{t-1} . Moreover, we can assume without loss of generality, that the initial step is zero because it is independent of D_0 . Thus, from (60), we can find at each time instant a $D_t \in (0, \infty)$ such that the rate is $R_t^* \in [0, \infty)$. Since the rate distortion problem is equivalent to the distortion rate problem (see, e.g., [45, Chapter 10]) we can immediately compute the total-distortion rate function, denoted by $D_{\text{sum}}^{\text{IID},1}(R)$, as follows:

$$D_{\text{sum}}^{\text{IID},1}(R) \triangleq \sum_{t=1}^n D(R_t^*) = \sum_{t=1}^{n-1} \frac{\sigma_{w_t}^2}{2^{2R_t^*} - \alpha_t^2} + 2^{-2R_n^*}. \quad (61)$$

Substituting $D(R_t^*)$ at each time instant in (59) the result follows.

(2) This follows similarly to Theorem 3, (2), i.e., if the quantized MMSE distortion is precisely

equal to the Gaussian MMSE distortion. This can be obtained if and only if a MMSE quantizer is ideal.

This completes the proof. ■

REFERENCES

- [1] X. Zhang, Q. Han, and X. Yu, "Survey on recent advances in networked control systems," *IEEE Transactions on Industrial Informatics*, vol. 12, no. 5, pp. 1740–1752, Oct 2016.
- [2] H. Viswanathan and T. Berger, "Sequential coding of correlated sources," *IEEE Transactions on Information Theory*, vol. 46, no. 1, pp. 236–246, Jan 2000.
- [3] V. N. Koshelev, "Hierarchical coding of discrete sources," *Probl. Peredachi Inf.*, vol. 3, no. 16, pp. 31–49, 1980.
- [4] W. H. R. Equitz and T. M. Cover, "Successive refinement of information," *IEEE Transactions on Information Theory*, vol. 37, no. 2, pp. 269–275, Mar 1991.
- [5] B. Rimoldi, "Successive refinement of information: characterization of the achievable rates," *IEEE Transactions on Information Theory*, vol. 40, no. 1, pp. 253–259, Jan 1994.
- [6] H. S. Witsenhausen, "On the structure of real-time source coders," *The Bell System Technical Journal*, vol. 58, no. 6, pp. 1437–1451, July 1979.
- [7] N. Gaarder and D. Slepian, "On optimal finite-state digital transmission systems," *IEEE Transactions on Information Theory*, vol. 28, no. 2, pp. 167–186, 1982.
- [8] V. S. Borkar, S. K. Mitter, and S. Tatikonda, "Optimal sequential vector quantization of Markov sources," *SIAM Journal on Control and Optimization*, vol. 40, no. 1, pp. 135–148, 2001.
- [9] D. Teneketzis, "On the structure of optimal real-time encoders and decoders in noisy communication," *IEEE Transactions on Information Theory*, vol. 52, no. 9, pp. 4017–4035, Sept 2006.
- [10] T. Linder and S. Yüksel, "On optimal zero-delay coding of vector Markov sources," *IEEE Transactions on Information Theory*, vol. 60, no. 10, pp. 5975–5991, Oct 2014.
- [11] R. G. Wood, T. Linder, and S. Yüksel, "Optimal zero delay coding of Markov sources: Stationary and finite memory codes," *IEEE Transactions on Information Theory*, vol. 63, no. 9, pp. 5968–5980, Sept 2017.
- [12] P. A. Stavrou, J. Østergaard, and C. D. Charalambous, "Zero-delay rate distortion via filtering for vector-valued Gaussian sources," *IEEE Journal of Selected Topics in Signal Processing*, vol. 12, no. 5, pp. 841–856, Oct 2018.
- [13] N. Ma and P. Ishwar, "On delayed sequential coding of correlated sources," *IEEE Transactions on Information Theory*, vol. 57, no. 6, pp. 3763–3782, 2011.
- [14] E. H. Yang, L. Zheng, D. K. He, and Z. Zhang, "Rate distortion theory for causal video coding: Characterization, computation algorithm, and comparison," *IEEE Transactions on Information Theory*, vol. 57, no. 8, pp. 5258–5280, Aug 2011.
- [15] E. H. Yang, L. Zheng, and D. K. He, "On the information theoretic performance comparison of causal video coding and predictive video coding," *IEEE Transactions on Information Theory*, vol. 60, no. 3, pp. 1428–1446, March 2014.
- [16] M. Torbatian and E. h. Yang, "Causal coding of multiple jointly Gaussian sources," in *2012 50th Annual Allerton Conference on Communication, Control, and Computing (Allerton)*, Oct 2012, pp. 2060–2067.
- [17] A. Khina, V. Kostina, A. Khisti, and B. Hassibi, "Tracking and control of Gauss-Markov processes over packet-drop channels with acknowledgments," *IEEE Transactions on Control of Network Systems*, vol. 6, no. 2, pp. 549–560, June 2019.

- [18] N. Farvardin and J. Modestino, "Rate-distortion performance of dpcm schemes for autoregressive sources," *IEEE Transactions on Information Theory*, vol. 31, no. 3, pp. 402–418, May 1985.
- [19] R. Zamir, Y. Kochman, and U. Erez, "Achieving the Gaussian rate-distortion function by prediction," *IEEE Transactions on Information Theory*, vol. 54, no. 7, pp. 3354–3364, July 2008.
- [20] A. K. Gorbunov and M. S. Pinsker, "Nonanticipatory and prognostic epsilon entropies and message generation rates," *Problems of Information Transmission*, vol. 9, no. 3, pp. 184–191, 1973.
- [21] P. A. Stavrou, T. Charalambous, C. D. Charalambous, and S. Loyka, "Optimal estimation via nonanticipative rate distortion function and applications to time-varying Gauss-Markov processes," *SIAM Journal on Control and Optimization*, vol. 56, no. 5, pp. 3731–3765, October 2018.
- [22] R. Zamir, *Lattice Coding for Signals and Networks*. Cambridge: Cambridge University Press, 2014.
- [23] J. H. Conway and N. J. A. Sloane, *Sphere-packings, Lattices, and Groups*, 3rd ed. New York, NY, USA: Springer-Verlag New York, Inc., 1999.
- [24] Y. Oohama, "The rate-distortion function for the quadratic Gaussian CEO problem," *IEEE Transactions on Information Theory*, vol. 44, no. 3, pp. 1057–1070, May 1998.
- [25] H. Marko, "The bidirectional communication theory—A generalization of information theory," *IEEE Transactions on Communications*, vol. 21, no. 12, pp. 1345–1351, Dec. 1973.
- [26] J. L. Massey, "Causality, feedback and directed information," in *International Symposium on Information Theory and its Applications (ISITA '90)*, Nov. 27-30 1990, pp. 303–305.
- [27] T. Weissman and E. Ordentlich, "The empirical distribution of rate-constrained source codes," *IEEE Transactions on Information Theory*, vol. 51, no. 11, pp. 3718–3733, Nov 2005.
- [28] A. K. Gorbunov and M. S. Pinsker, "Prognostic epsilon entropy of a Gaussian message and a Gaussian source," *Problems of Information Transmission*, vol. 10, no. 2, pp. 93–109, 1974.
- [29] C. D. Charalambous, P. A. Stavrou, and N. U. Ahmed, "Nonanticipative rate distortion function and relations to filtering theory," *IEEE Transactions on Automatic Control*, vol. 59, no. 4, pp. 937–952, April 2014.
- [30] P. A. Stavrou, T. Charalambous, and C. D. Charalambous, "Finite-time nonanticipative rate distortion function for time-varying scalar-valued Gauss-Markov sources," *IEEE Control Systems Letters*, vol. 2, no. 1, pp. 175–180, Jan 2018.
- [31] K. Atkinson, *An Introduction to Numerical Analysis*, 2nd ed. John Wiley & Sons, 1991.
- [32] V. Kostina and B. Hassibi, "Rate-cost tradeoffs in control," *IEEE Transactions on Automatic Control*, pp. 1–1, 2019.
- [33] S. Yüksel and T. Basar, *Stochastic networked control systems: stabilization and optimization under information constraints*. New York, NY: Springer, 2013.
- [34] Y. Bar-Shalom and E. Tse, "Dual effect, certainty equivalence, and separation in stochastic control," *IEEE Transactions on Automatic Control*, vol. 19, no. 5, pp. 494–500, October 1974.
- [35] L. Bao, M. Skoglund, and K. H. Johansson, "Iterative encoder-controller design for feedback control over noisy channels," *IEEE Transactions on Automatic Control*, vol. 56, no. 2, pp. 265–278, Feb 2011.
- [36] M. Fu, "Lack of separation principle for quantized linear quadratic gaussian control," *IEEE Transactions on Automatic Control*, vol. 57, no. 9, pp. 2385–2390, Sept 2012.
- [37] S. Yüksel, "Jointly optimal LQG quantization and control policies for multi-dimensional systems," *IEEE Transactions on Automatic Control*, vol. 59, no. 6, pp. 1612–1617, June 2014.
- [38] D. P. Bertsekas, *Dynamic programming and optimal control*. Athena Scientific, 2005.
- [39] S. Tatikonda, A. Sahai, and S. Mitter, "Stochastic linear control over a communication channel," *IEEE Transactions on Automatic Control*, vol. 49, pp. 1549–1561, 2004.

- [40] E. I. Silva, M. S. Derpich, and J. Østergaard, “A framework for control system design subject to average data-rate constraints,” *IEEE Transactions on Automatic Control*, vol. 56, no. 8, pp. 1886–1899, Aug 2011.
- [41] E. I. Silva, M. S. Derpich, J. Østergaard, and M. A. Encina, “A characterization of the minimal average data rate that guarantees a given closed-loop performance level,” *IEEE Transactions on Information Theory*, vol. 61, no. 8, pp. 2171–2186, Aug 2016.
- [42] T. Tanaka, K. H. Johansson, T. Oechtering, H. Sandberg, and M. Skoglund, “Rate of prefix-free codes in LQG control systems,” in *IEEE International Symposium on Information Theory (ISIT)*, July 2016, pp. 2399–2403.
- [43] A. Tsiamis, K. Gatsis, and G. J. Pappas, “State estimation codes for perfect secrecy,” in *Conference on Decision and Control*, Dec 2017, pp. 176–181.
- [44] N. S. Jayant and P. Noll, *Digital Coding of Waveforms: Principles and Applications to Speech and Video*. Prentice Hall, 1990.
- [45] T. M. Cover and J. A. Thomas, *Elements of Information Theory*, 2nd ed. John Wiley & Sons, Inc., Hoboken, New Jersey, 2006.