

# Virtual Machines Embedding for Cloud PON AWGR and Server Based Data Centres

Randa A.T. Alani, Taisir E.H. El-Gorashi, and Jaafar M.H. Elmirghani

*School of Electronic and Electrical Engineering, University of Leeds, LS2 9JT, United Kingdom*

## ABSTRACT

Virtualization is one of the most active areas in cloud computing networks research. Passive Optical Networks (PONs) provide several benefits to the data centres such as low cost, low energy consumption and high bandwidth. In this study, we investigate the embedding of various cloud applications in PON AWGR and Server Based Data Centres. We optimize the power consumption of cloud applications' placement through the use of Mixed Integer Linear Programming (MILP). The results show that a reduction in power consumption by 24%, 22% and 26% can be achieved compared to non-optimized embedding of 5, 10 and 15 VMs respectively.

**Keywords:** passive optical network (PON), data centre, energy efficiency, virtual machines embedding, cloud computing, arrayed waveguide grating routers (AWGRs).

## 1. INTRODUCTION

Recent developments in cloud computing have increased the need for scalable, cost effective, high bandwidth, low power consumption data centre infrastructures [1] – [8]. The developments in data centre energy efficiency have accelerated making use of new techniques to improve the energy efficiency of core and access communication networks [9] – [17]. These energy efficient optical network architectures found their way to data centres. The increase in data intensive applications and processing requirements was an additional driver for growth in data centre demands [18] – [21]. Network virtualization technologies developed to offer better control of the network and better utilization of the network resources [22] – [24] became important candidates for the development of virtualized high data rate optical data centre networks. Several studies have proposed Passive Optical Networks (PONs) in data centre infrastructures due to their proven performance in access networks. With similar objectives, we introduced different novel PON architectures to handle the inter-rack and intra-rack communication of a data centre as in [25] – [33]. In [30] we studied one of the PON designs proposed in [29] where Arrayed Waveguide Grating Routers (AWGRs) and servers are used to route traffic and showed that power consumption is reduced by 83% compared to the Fat-Tree architecture [34] and by 93% compared to the BCube architecture [35]. In this paper, we further investigate this PON architecture for considering cloud applications. We developed a developed Mixed Integer Linear Programming (MILP) model that optimizes power consumption by optimizing the embedding of virtual machines' requests.

The remainder of this paper is structured as follows: In Section 2, the PON DCN Design with AWGR and Server Based Routing is briefly described. In Section 3, the power consumption results are presented. Finally, conclusions are provided in Section 4.

## 2. THE AWGR AND SERVER BASED-PON DCN ARCHITECTURE

In this architecture, as shown in Fig. 1, the servers in PON cells are placed into groups. A group is made of multiple subgroups where the number of servers hosted by a subgroup depends on the splitting ratio of the TDM PON connected to it. This architecture involves two types of communication: intra group and inter group communication. Intra group communication can be either between servers in a subgroup (intra subgroup communications) or between servers in different subgroups in the group (inter subgroup communication). The subgroups in each group are connected to a special server whose task is to maintain the inter subgroup and inter group communication

## 3. POWER OPTIMIZATION OF VIRTUAL MACHINES EMBEDDING IN PON DATA CENTER

A MILP model is developed to minimize the power consumption of a PON data centre shown in Fig.1 by optimizing the embedding of virtual machines requests. Two groups are considered where each group is divided into two subgroups. The number of servers in each subgroup is varied (2, 3,4) to study its effect on the total power consumption. Also, the two types of communication: intra group and inter group communication are covered by this reduced architecture. A number of VM requests (5, 10, and 15) were considered and Table 1 shows the

different CPU, memory, and communication traffic demands of VMs that were studied. Each VM can have communication with 1-3 other VMs.

This model guarantees that the memory and processing demands allocated to a server do not exceed the server's capacity. Also, it ensures that the special server's processing capacity used for 'requests forwarding' does not exceed the special server's overall capacity.

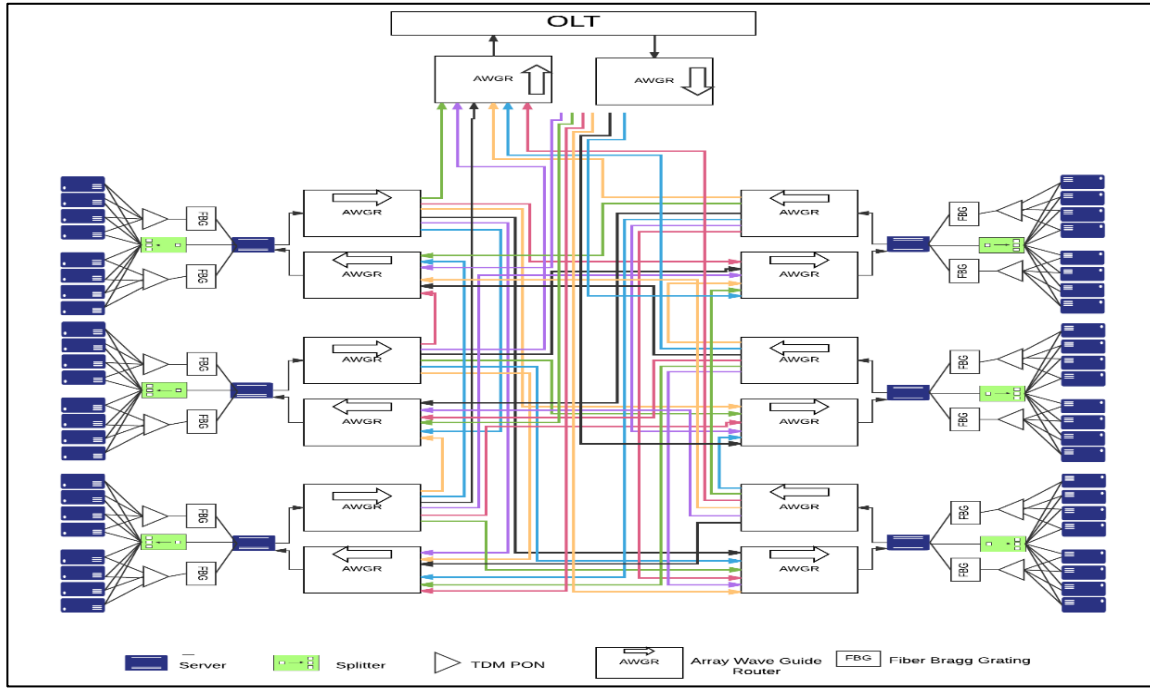

Figure 1: Option 4 architecture

Table 1: Input data for the model

Traffic demand between VMs	40-200 Mb/s
Capacity of physical link	10 Gbps
Idle power consumption of a server	201 W [36]
Maximum power consumption of a server	301 W [36]
Processing capacity requested by a client in $M$ CPU cycles	500-2000
Processing capacity of server	2.5 GHz
Portion of a special server's processing capacity used for forwarding one request	5%
Processing capacity of special server	2.5 GHz
Total ONU power consumption	2.5 W [37]
ONU data rate	10 Gbps
VM request requirements of RAM	500-2000 MB
Memory capacity (RAM) of server	8 GB

In addition, traffic from servers in each PON group communicating with other servers is limited to the shared link capacity. Furthermore, we ensure that the traffic forwarded by a special server does not exceed its ONU rate. This model is used to minimize the total power consumption composed of servers, special servers and ONUs power consumption. This is achieved through optimizing the servers selected to provision VMs.

The power consumption of resource provisioning for the PON architecture is presented in Fig. 2. As shown in Fig. 2, the power consumption of placing VMs is inversely proportional to the number of servers in each subgroup (in general). The idea behind this is that whenever VMs that have traffic between them, are placed in one subgroup, there will be no need for activating the special servers connected to the subgroup. This more likely happens when the number of servers in a subgroup is high enough. Also, even if some VMs are distributed over more than one subgroup, the model tries to locate VMs with high traffic in the same subgroup as much as possible. Accordingly,

a small amount of traffic traverses through the special servers connecting these VMs. This is important because the amount of power consumed by special servers is affected by the amount of traffic traversing them. In other words, whenever the number of servers is low, the VMs will distribute over more than one subgroup which activates the special servers and consumes more power. It worthy mentioning that increasing the number of servers in a subgroup is limited by the splitting ratio of the TDM PON connected to it.

It is clear from Fig. 3 that the number of activated servers for VMs placement is affected by the number of VMs allocated regardless of the number of servers' in each subgroup. In contrast, the number of activated 'special servers', changes according to change in the number of both VMs and servers in each group. This is shown in Fig. 4 where the change in the number of activated special servers is inversely proportional to the number of servers in each group and directly proportional to the number of placed VMs.

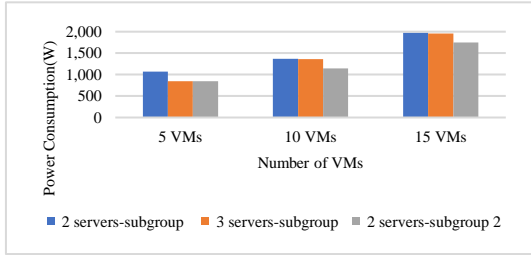

Figure 2: VMs power consumption based on the number of servers in each subgroup

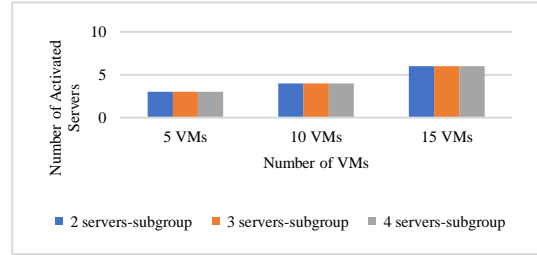

Figure 3: Number of activated servers based on the number of servers in each subgroup

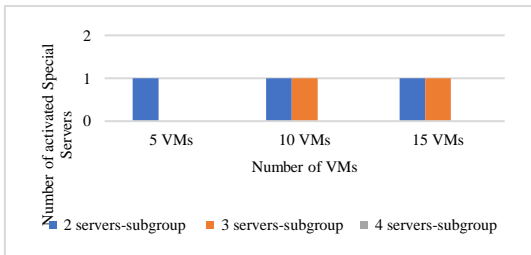

Figure 4: Number of activated Special Servers based on the number of servers in each subgroup

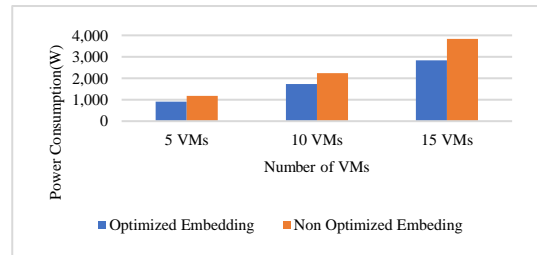

Figure 5: VMs power consumption for optimized embedding and Non optimized embedding

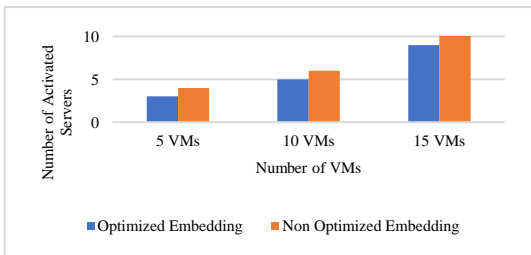

Figure 6: Number of activated servers for optimized embedding and Non optimized VMs' embedding

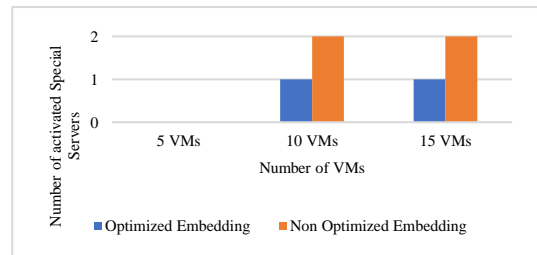

Figure 7: Number of activated Special Servers for optimized embedding and Non optimized VMs' embedding

Fig. 5 clearly shows that the optimized embedding model reduces the power consumption compared to the non-optimized embedding model. The main reason behind the energy savings is the minimized number of servers, 'special server' used for allocating VMs and providing communication as shown in Fig. 6 and Fig. 7. Furthermore, minimizing the traffic passing through the special servers reduces their operational power and ONU power consumption. This is done by allocating VMs that communicate with each other considering the following priority order: same server, subgroup or group as much as possible. Accordingly, our model succeeded in minimizing the power consumption by 24%, 22% and 26% compared to Non-optimized embedding model of 5, 10 and 15 VMs respectively.

#### 4. CONCLUSIONS

This paper has investigated the placement of VMs in PON data centre architectures where Arrayed Waveguide Grating Routers (AWGRs) and servers are used to route traffic. We have optimized the power consumption of cloud applications allocation using a MILP model and presented a range of results. The results have shown that power consumption is affected by the number of servers in each subgroup due to the change in the number of activated special servers. Our study shows that the proposed model reduces the power consumption by 24%, 22% and 26% compared to Non-optimized embedding model of 5, 10 and 15 VMs respectively.

#### ACKNOWLEDGEMENTS

The authors would like to acknowledge funding from the Engineering and Physical Sciences Research Council (EPSRC), INTERNET (EP/H040536/1) and STAR (EP/K016873/1). Mrs. Randa A.T. Alani would like to acknowledge The Iraqi Ministry of Higher Education and Scientific Research for funding her scholarship. All data are provided in full in the results section of this paper.

#### REFERENCES

1. McGarry, M.P., M. Reisslein, and M.J.I.C.M. Maier, *WDM Ethernet passive optical networks*. 2006. vol 44, No. 2, p. 15-22.
2. Dong, X., El-Gorashi, T.E.H. and Elmirghani, J.M.H., "Green IP over WDM Networks with Data Centres," *IEEE/OSA Journal of Lightwave Technology*, vol. 27, No. 12, pp. 1861 - 1880, 2011.
3. Al-Salim, A.M., Lawey, A., El-Gorashi, T.E.H., and Elmirghani, J.M.H., "Energy Efficient Big Data Networks: Impact of Volume and Variety," *IEEE Transactions on Network and Service Management*, vol. 15, No. 1, pp. 458 - 474, 2018.
4. Al-Salim, A.M., El-Gorashi, T.E.H., Lawey, A., and Elmirghani, J.M.H., "Greening big data networks: velocity impact," *IET Optoelectronics*, vol. 12, No. 3, pp. 126-135, 2018.
5. Hadi, M.S., Lawey, A., El-Gorashi, T.E.H., and Elmirghani, J.M.H., "Patient-Centric Cellular Networks Optimization using Big Data Analytics," *IEEE Access*, vol. 7, 2019.
6. Hadi, M.S., Lawey, A.Q., El-Gorashi, T.E.H., and Elmirghani, J.M.H. "Big Data Analytics for Wireless and Wired Network Design: A Survey, Elsevier Computer Networks, vol. 132, No. 2, pp. 180-199, 2018.
7. Ali, H.M.M., Lawey, A.Q., El-Gorashi, T.E.H., and Elmirghani, J.M.H. "Future Energy Efficient Data Centers With Disaggregated Servers," *IEEE/OSA Journal of Lightwave Technology*, vol. 35, No. 24, pp. 5361 – 5380, 2017.
8. Lawey, A., El-Gorashi, T.E.H. and Elmirghani, J.M.H., "BitTorrent Content Distribution in Optical Networks," *IEEE/OSA Journal of Lightwave Technology*, vol. 32, No. 21, pp. 3607 – 3623, 2014.
9. Elmirghani, J.M.H., Nonde, L., Lawy, A.Q., El-Gorashi, T.E.H., Musa, M.O.I., Dong, X., Hinton, K., and Klein T., "Energy Efficiency Measures for Future Core Networks, IEEE/OSA Optical Fibre Communications (OFC 2017) conference, 19 – 23 March 2017, LA, California, USA, invited paper.
10. Elmirghani, J.M.H., Klein, T., Hinton, K., Nonde, L., Lawey, A.Q., El-Gorashi, T.E.H., Musa, M.O.I., and Dong, X., "GreenTouch GreenMeter Core Network Energy Efficiency Improvement Measures and Optimization [Invited]," *IEEE/OSA Journal of Optical Communications and Networking*, vol. 10, No. 2, pp. 250-269, 2018.
11. Bathula, B., Alresheedi M., and Elmirghani, J.M.H., "Energy efficient architectures for optical networks," *Proc IEEE London Communications Symposium*, London, Sept. 2009.
12. Musa, M., El-Gorashi, T.E. and Elmirghani, J.M.H., "Bounds for Energy-Efficient Survivable IP Over WDM Networks with Network Coding," *IEEE/OSA Journal of Optical Communications and Networking*, vol. 10, no. 5, pp. 471-481, 2018.
13. X. Dong, T.E.H. El-Gorashi and J.M.H. Elmirghani, "On the Energy Efficiency of Physical Topology Design for IP over WDM Networks," *IEEE J. of Lightwave Technology*, vol. 30, pp.1931-1942, 2012.
14. X. Dong, T. El-Gorashi, and J. Elmirghani, "IP Over WDM Networks Employing Renewable Energy Sources," *Lightwave Technology, Journal of*, vol. 29, no. 1, pp. 3-14, Jan 2011.
15. B. Bathula, and J.M.H. Elmirghani, "Energy Efficient Optical Burst Switched (OBS) Networks," *IEEE GLOBECOM'09*, Honolulu, Hawaii, USA, November 30-December 04, 2009.
16. X. Dong, T.E.H. El-Gorashi and J.M.H. Elmirghani, "Green Optical OFDM Networks," *IET Optoelectronics*, vol. 8, No. 3, pp. 137 – 148, 2014.
17. Musa, M., El-Gorashi, T.E. and Elmirghani, J.M.H., "Bounds on GreenTouch GreenMeter Network Energy Efficiency," *IEEE/OSA Journal of Lightwave Technology*, vol. 36, No. 23, pp. 5395-5405, 2018.
18. Osman, N. I., El-Gorashi, T.E.H., Krug, L. and Elmirghani, "Energy-Efficient Future High-Definition TV," *IEEE/OSA Journal of Lightwave Technology*, vol. 32, No. 13, pp. 2364 – 2381, 2014.

19. Musa, M., El-Gorashi, T.E. and Elmirghani, J.M.H., "Energy Efficient Survivable IP-Over-WDM Networks With Network Coding," *IEEE/OSA Journal of Optical Communications and Networking*, vol. 9, No. 3, pp. 207-217, 2017.
20. Lawey, A.Q., El-Gorashi, T.E., and Elmirghani, J.M.H., "Renewable Energy in Distributed Energy Efficient Content Delivery Clouds," *Proc. IEEE International Conference on Communications (ICC'15)*, London, 8-12 June 2015.
21. Osman, N.I., El-Gorashi, T.E.H. and Elmirghani, J.M.H., "The impact of content popularity distribution on energy efficient caching," *Proc IEEE 15th International Conference on Transparent Optical Networks ICTON 2013*, Cartagena, Spain, June 23-27, 2013.
22. Nonde, L., El-Gorashi, T.E.H. and Elmirghani, J.M.H., "Energy Efficient Virtual Network Embedding for Cloud Networks," *IEEE/OSA Journal of Lightwave Technology*, vol. 33, No. 9, pp. 1828-1849, 2015.
23. Nonde, L., El-Gorashi, T.E.H. and Elmirghani, J.M.H., "Virtual Network Embedding Employing Renewable Energy Sources," *IEEE Global Com. Conference (GLOBECOM 2016)*, 04-08 Dec 2016, Washington DC USA.
24. Al-Quzweeni, A.N., Lawey, A., El-Gorashi, T.E.H., and Elmirghani, J.M.H., "Optimized Energy Aware 5G Network Function Virtualization," *IEEE Access*, vol. 7, 2019.
25. Hammadi, A., El-Gorashi, T.E.H., and Elmirghani, J.M.H., "High Performance AWGR PONs in Data Centre Networks," *Proc IEEE 17th International Conference on Transparent Optical Networks (ICTON)*, Budapest, Hungary, July 5-9, 2015..
26. Hammadi, A., El-Gorashi, T.E.H., Musa, M.O.I. and Elmirghani, J.M.H., "Server-Centric PON Data Center Architecture," *Proc IEEE 18th International Conference on Transparent Optical Networks (ICTON)*, Trento, Italy, July 10-14, 2016, invited paper.
27. Hammadi, A., Elgorashi, T.E.H., and Elmirghani, J.M.H., "Energy-efficient software-defined AWGR-based PON data center network," *Proc IEEE 18th International Conference on Transparent Optical Networks (ICTON)*, Trento, Italy, July 10-14, 2016.
28. Hammadi, A., El-Gorashi, T.E.H., Musa, M.O.I. and Elmirghani, J.M.H., "Resource Provisioning for Cloud PON AWGR-Based Data Center Architecture," *Proc IEEE 21st European Conference on Network and Optical Communications (NOC)*, 1-3 June 2016, Lisbon, Portugal.
29. Elmirghani, J.M.H., Hammadi, A. and El-Gorashi, T.E.H., "Data Centre Networks," UK patent number: GB1421014.0, 27 November 2014.
30. Alani, R., Hammadi, A., Elgorashi, T.E.H., and Elmirghani, J.M.H., "PON Data Centre Design with AWGR and Server based Routing," *Proc IEEE 19th International Conference on Transparent Optical Networks (ICTON)*, Girona, Catalonia, Spain, 2-6 July 2017, *Invited Paper*.
31. Mohamed, S.H., El-Gorashi, T.E.H. and Elmirghani, J.M.H., "On the Energy Efficiency of MapReduce Shuffling Operations in Data Centers," *Proc IEEE 19th International Conference on Transparent Optical Networks (ICTON)*, Girona, Catalonia, Spain, 2-6 July 2017, *Invited Paper*.
32. Mohamed, S.H., El-Gorashi, T.E.H. and Elmirghani, J.M.H., "Energy efficiency of server-centric PON data center architecture for fog computing," *Proc IEEE 20th International Conference on Transparent Optical Networks (ICTON)*, Bucharest, Romania, 1-5 July 2018.
33. Mohamed, S.H., El-Gorashi, T.E.H. and Elmirghani, J.M.H., "Impact of link failures on the performance of MapReduce in data center networks," *Proc IEEE 20th International Conference on Transparent Optical Networks (ICTON)*, Bucharest, Romania, 1-5 July 2018.
34. Al-Fares, M., Loukissas, A. and Vahdat, A., "A scalable, commodity data center network architecture," *ACM SIGCOMM Computer Communication Review*, 2008.
35. Guo, C., et al., "BCube: a high performance, server-centric network architecture for modular data centers," *ACM SIGCOMM Computer Communication Review*, vol. 39, No. 4, pp. 63-74, 2009.
36. Kliazovich, D., Bouvry, P., and Khan, S., "GreenCloud: a packet-level simulator of energy-aware cloud computing data centers," vol. 62, No. 3, pp. 1263-1283, 2012.
37. Grobe, K., et al., "Cost and energy consumption analysis of advanced WDM-PONs," *IEEE Communications Magazine*, vol. 49, No. 2, pp. s25-s32, 2011.