

Diagrammatics of the quartic $O(N)^3$ -invariant Sachdev-Ye-Kitaev-like tensor model

Valentin Bonzom,^{1,*} Victor Nador,^{2,†} and Adrian Tanasa^{3,4,5,‡}

¹*LIPN, UMR CNRS 7030, Institut Galilée, Université Paris 13,
99, avenue Jean-Baptiste Clément, 93430 Villetaneuse, France, EU*

²*LaBRI, UMR CNRS 5800, Université de Bordeaux,
351 cours de la Libération, 33405 Talence, France, EU*

³*LaBRI, Université de Bordeaux, 351 cours de la Libération, 33405 Talence, France, EU*

⁴*H. Hulubei Nat. Inst. Phys. Nucl. Engineering, P.O.B. MG-6, 077125 Magurele, Romania, EU*

⁵*I. U. F., 1 rue Descartes, 75005 Paris, France, EU*

(Dated: March 11, 2022)

Various tensor models have been recently shown to have the same properties as the celebrated Sachdev-Ye-Kitaev (SYK) model. In this paper we study in detail the diagrammatics of two such SYK-like tensor models: the multi-orientable (MO) model which has a $U(N) \times O(N) \times U(N)$ symmetry and a quartic $O(N)^3$ -invariant model whose interaction has the tetrahedral pattern. We show that the Feynman graphs of the MO model can be seen as the Feynman graphs of the $O(N)^3$ -invariant model which have an orientable jacket. Then we present a diagrammatic toolbox to analyze the $O(N)^3$ -invariant graphs. This toolbox allows for a simple strategy to identify all the graphs of a given order in the $1/N$ expansion. We apply it to the next-to-next-to-leading and next-to-next-to-next-to-leading orders which are the graphs of degree 1 and $3/2$ respectively.

I. INTRODUCTION

The fermionic quantum mechanical Sachdev-Ye-Kitaev (SYK) model (in the form introduced in [16]) has attracted, in the recent years, a huge amount of interest from the high energy physics community (see, for example, [20], [11], [22], [13] and references within). A crucial diagrammatic property of the SYK model is that the model is dominated, in the large N limit (N being here the number of fermions), by a simple class of graphs called melonic graphs. A combinatorial proof of the melonic dominance of the SYK model has been recently given in [3].

In [26], Witten related the SYK model to the so-called colored tensor model, model originally introduced and extensively studied in the works of Gurău and collaborators (see the book [14] and references within). This SYK-like tensor model is known today as the Gurău-Witten model.

In [17], Klebanov and Tarnopolsky related the SYK model to another tensor model with an $O(N)^3$ -symmetry¹ (N being here the size of the tensor in each entry). This model, whose purely combinatorial part was originally introduced by Carrozza and Tanasa in [6], will be referred in this article (as it is already referred in a part of the literature) as the Carrozza-Tanasa-Klebanov-Tarnopolsky (CTKT), or the $O(N)^3$ -invariant model (although it is only one, with quartic interactions, of all possible $O(N)^3$ -invariant models).

Also in [17], the SYK model was related to another tensor model having a $U(N) \times O(N) \times U(N)$ symmetry, model whose combinatorics is known as the multi-orientable (MO) tensor model, and studied in a series of several papers [24], [8], [10], [15] (see also the review paper [25]).

It is worth emphasizing here that all these tensor models are known to have a well-defined large N limit (dominated by the same melonic graphs as the ones which dominate the large N limit of the SYK model). Tensor models thus enlarge the club of models known to indeed have large N limits, which already consisted in vector and matrix models – see the TASI lectures [18] for a recent review.

For the sake of completeness, let us also mention that the SYK model is known to be invariant under the action of the orthogonal group. However, SYK-like quantum mechanics with $Sp(N)$ symmetry has been recently investigated in [5].

Thus, based on earlier works in the tensor model literature, reference [17] proposed two SYK-like models whose combinatorics are the MO model and the $O(N)^3$ -invariant model. We will analyze both from the purely combinatorial point of view of the Feynman graphs.

* bonzom@lipn.univ-paris13.fr

† victor.nador@ens-lyon.fr

‡ ntanasa@u-bordeaux.fr

¹ Let us emphasize that the symmetry of tensor models studied here is $O(N)^3$ and not $O(N)$. Tensor models invariant under the action of the $O(N)$ group have been recently studied in [19], [1] and [4].

It is known that the MO graphs form a subset of $O(N)^3$ -invariant graphs [6]. In Theorem 3 we identify this subset as the graphs with an orientable jacket. Jackets are key objects which are canonically obtained from the Feynman graphs (see [8] and [6]). They are ribbon graphs so one can make use of the notion of genus of these ribbon graphs². It is actually the sum of the genera of the jackets which defines the degree. The latter is a positive half-integer which actually controls the $1/N$ expansion of tensor models.

Then we present a set of diagrammatic techniques to analyze the $O(N)^3$ -invariant graphs of the CTKT model. They converge to a strategy to identify all graphs of fixed degree. The strategy is to distinguish first the 2-particle-reducible (2PR) graphs from the 2-particle-irreducible (2PI) graphs. We recall that 2PR graphs are graphs with a 2-edge-cut and 2PI graphs are those without any 2-edge-cuts. The 2PR graphs of degree ω are easily obtained from those of smaller degrees. Then the strategy to find the 2PI graphs of fixed degree is to distinguish those with and without dipoles. Remarkably, all steps of the strategy except one only require to know the graphs of smaller degrees. The exception consists in finding the graphs of fixed degree which are 2PI and dipole-free. This step requires an independent analysis.

Graphs of degree 0 and of degree $1/2$ are leading and next-to-leading order and consist in melonic graphs and tadpole graphs respectively. We apply our strategy to find all the graphs of degree 1, which are the next-to-next-to-leading order graphs. Theorem 4 gives the unique 2PI, dipole-free graph of degree 1, then Theorem 5 gives all the graphs of degree 1. We go as far as the next order in the $1/N$ expansion, which are the graphs of degree $3/2$. Theorem 6 shows that there is a unique, explicit graph of degree $3/2$ which is 2PI and dipole-free. The other steps of the procedure to find all the graphs of degree $3/2$ follow the exact same line of reasoning and are thus left to the reader.

The paper is organized as follows. As jackets and their orientability are a key ingredient in our work, we present a quick review of the orientability of discrete surfaces in Section II, both from the point of view of ribbon graphs and of 3-colored graphs, which are the two relevant representations of discrete surfaces here. Then we present the two SYK-like models in Section III. We prove that MO graphs are $O(N)^3$ -invariant graphs with an orientable jacket in Section IV. Then in Section V we present our diagrammatic toolbox for the analysis of $O(N)^3$ -invariant graphs, ending in subsection V F with our strategy to find all graphs of any given fixed degree. In Section VI we recall the graphs of degree 0 and $1/2$. In Section VII, we apply our strategy in detail and find all graphs of degree 1. Our last result is exhibited in Section VIII which gives the unique graph of degree $3/2$ which is 2PI and dipole-free.

II. SHORT REVIEW OF ORIENTABILITY FOR DISCRETE SURFACES

A ribbon graph is a graph whose edges and vertices are thickened as ribbons. In addition to vertices and edges, it has faces which are the connected components of the ribbon complement. A useful representation is in terms of 2-stranded graphs, where the ribbon is drawn as a couple of strands which delimits its edges. The faces are then identified as the closed strands.

A ribbon graph thus encodes a discrete surface, whose genus is given by Euler's formula. The standard representation of ribbon graphs is to draw all ribbon vertices as flat road crossings,



Along an edge, the ribbon can be either flat too or it can be twisted,



The number of twists is modulo 2. A non-loop edge can be twisted and untwisted while taking the mirror image of one of its end vertices and twisting/untwisting the other incident non-loop edges. Two ribbon graphs are equivalent if they differ by a sequence of such operations. We refer to [21] for all topological aspects of ribbon graphs, in particular the following theorem.

Theorem 1. A ribbon graph without twist encodes an orientable surface.

² Let us also mention that, from a mathematical point of view, jackets can be seen as Heegaard surfaces canonically associated to tensor graphs [23].



Figure 1: On the left is a bipartite 3-colored graph representing the sphere and on the right a non-bipartite graph representing the projective plane.

Another representation of discrete surfaces which we will encounter is as edge-colored, 3-valent graphs, whose edges carry the colors $\{0, 1, 2\}$ and every vertex has exactly every color incident once. A discrete surface is reconstructed by using as faces the bicolored cycles of the graph, i.e. the cycles with colors $\{0, 1\}$, $\{0, 2\}$, $\{1, 2\}$. Notice that any ribbon graph can be transformed into an edge-colored graph by barycentric subdivisions, both encoding the same surface. In the case of edge-colored graph-encoded surface, the theorem about orientability is the following [7].

Theorem 2. An edge-colored graph is bipartite if and only if the corresponding surface is orientable.

An illustration is given in Figure 1.

Remark 1. *Canonical embedding.* In the bipartite case, there is a natural way to construct a ribbon graph of the same genus, for which the bicolored cycles become the faces. This graph is obtained by using a cyclic ordering of the colors, say (012) , at white vertices and the other ordering, (021) at black vertices. In practice, one can draw the edges around a white vertex with the colors (012) counter-clockwise, and the other way around for black vertices. Thickening this embedded graph gives a ribbon graph without twist.

Any non-bipartite colored graph, of half-integer genus g , can still be embedded without crossing on a surface of half-integer genus g in such a way that the bicolored cycles become the boundary of faces homeomorphic to discs and such that the union of those faces is the surface itself. In practice, one can always start from representing the bicolored cycles with colors $\{1, 2\}$ as polygons, with faces on the interior. Then the color 0 is added on the outside of the polygons of colors $\{1, 2\}$.

III. TWO SYK-LIKE TENSOR MODELS

In this section, we present the two SYK-like tensor models studied thereafter, namely the $O(N)^3$ -invariant model and the multi-orientable model (MO model). For each model, we give a brief presentation of its properties and discuss the structure of its Feynman graphs. The two models are studied for rank three tensor fields.

A. The $O(N)^3$ -invariant model, or the CTKT model

As already mentioned in the introduction, the $O(N)^3$ -invariant model was initially introduced in [6] in 2015; in 2016, in [17], this model was related to the SYK model. This model consist of a single real fermionic tensor ψ_{ijk} of size N with $O(N)$ symmetry on each of its indices:

$$\psi_{abc} \rightarrow \psi'_{a'b'c'} = O_{1a'}^a O_{2b'}^b O_{3c'}^c \psi_{abc}, \quad O_i \in O(N). \quad (3)$$

With this symmetry, we can build two different invariants of order 4 in ψ_{ijk} depending on how indices of the tensor are contracted. We can either have a **tetrahedral** interaction,

$$I_1 = \psi_{abc} \psi_{ade} \psi_{fbc} \psi_{fde} \quad (4)$$

or a “pillow”, also known as **melonic** interaction,

$$I_2 = \psi_{abc} \psi_{dbc} \psi_{aef} \psi_{def}. \quad (5)$$

These interaction terms can be represented diagrammatically by edge-colored graphs with four vertices of degree 3 given in Figure 2. This diagrammatic correspondence is such that each vertex represents a tensor and each incident edge represents an index. Each edge carries a color corresponding to its position on the tensor. An edge of color i connecting two vertices denotes a summation on the i -th index between two tensors. This makes sure that the

interactions are $O(N)^3$ -invariant. More generally, $O(N)^d$ - and $U(N)^d$ -invariant polynomials are called bubbles in the literature.

Notice that I_1 is fully symmetric under permutations of the colors, while there are in fact three different versions of I_2 (where the two dipoles can be connected by edges of color 1, or 2, or 3).

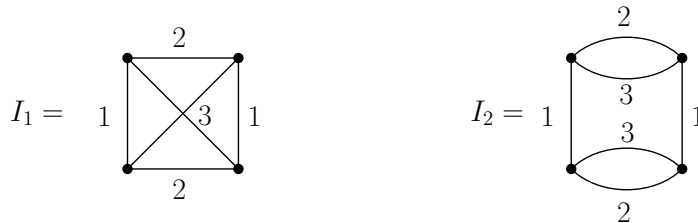

Figure 2: On the left, the tetrahedral bubble. On the right, a melonic bubble with 4 vertices.

In this paper, as in [17], we only study the tetrahedral interaction. The SYK-like $(0+1)$ -dimensional action writes

$$S_{CTKT} = \int dt \left(\frac{i}{2} \psi_{abc} \partial_t \psi_{abc} + \frac{\lambda}{4} \psi_{abc} \psi_{ade} \psi_{fbe} \psi_{fdc} \right). \quad (6)$$

Therefore, a Feynman graph of the model is represented as bubbles connected by propagators, which are represented as dashed edges, also referred to as 0 colored edge. Therefore, all the vertices of the Feynman graph are of valency 4 and have exactly one half-edge of each color $i \in \{0, 1, 2, 3\}$.

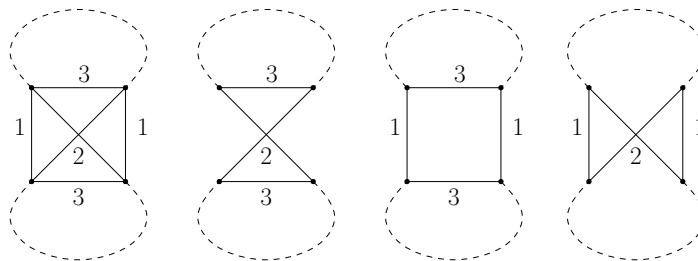

Figure 3: An example of a Feynman graph of the CTKT model and its three jackets

The **jacket** J_i of a graph G , for $i \in \{1, 2, 3\}$, is the graph obtained by deleting all edges of color i . If j, k denotes the complementary colors, $\{i, j, k\} = \{1, 2, 3\}$, then J_i is a 3-colored graph whose vertices are those of G and have degree 3, and whose edges have colors $0, j, k$. An example of a Feynman graph and its three jackets is given in Figure 3. Due to the structure of the tetrahedral bubble, all the jackets of a connected graph are connected. Therefore, a jacket represents a connected surface, whose genus is given by the Euler characteristic formula,

$$\chi_i = 2 - 2g_i = V - E(J_i) + F(J_i), \quad (7)$$

where g_i can be a half-integer. Here V is the number of vertices of G , $E(J_i)$ the number of edges of J_i and $F(J_i)$ the number of faces of J_i . For example, the jackets of Fig. 3 have $V = 4$, $E = 6$.

Since J_i has vertices of degree 3, $E(J_i) = 3V/2$. Moreover, for graphs encoding surfaces, the faces correspond to the bicolored cycles, with color pairs $\{0, j\}$, $\{0, k\}$ and $\{j, k\}$. Those bicolored cycles can be read either on J_i or directly on G . Notice that the bicolored cycles with colors $\{j, k\}$ lie within the bubbles and there is exactly one for each bubble. Denoting F_i, F_j, F_k the number of bicolored cycles with colors $\{0, i\}$, $\{0, j\}$, $\{0, k\}$, we have

$$F(J_i) = F_j + F_k + V/4. \quad (8)$$

We then get

$$2 - 2g_i = F_j + F_k - n, \quad (9)$$

where $n = V/4$ is the number of bubbles.

As mentioned above, the bicolored cycles of a jacket represent the faces of the corresponding discrete surface. Those bicolored cycles are also objects of the graph G and we will still call them faces for G . In particular, we call a **face**

of color i of G a bicolored cycle with colors $\{0, i\}$. A face has even length, with an equal number of edges of both its colors. The length of a face is defined by this number.

The degree of the graph which organizes the perturbative expansion of the model is given by the sum of the genera of the jackets,

$$\omega = g_1 + g_2 + g_3, \quad (10)$$

from which we know that $\omega \geq 0$. Using (9) for all three colors, one finds

$$\omega = 3 + \frac{3}{2}n - (F_1 + F_2 + F_3). \quad (11)$$

It was proved in [6] that the graph of degree 0 of this model were exactly the melonic graphs.

B. The MO model

As already mentioned in the introduction, the multi-orientable model was first introduced within a group field theory context [24]. A detailed review of this model can be found in [25]. This type of model was related to the SYK model in [17].

This model has a complex Fermionic tensor field ψ_{ijk} . However the symmetry associated to this tensor is $U(N) \times O(N) \times U(N)$. This stems from the interaction term of this model which is:

$$I = \psi_{abc}\bar{\psi}_{ade}\psi_{fbc}\bar{\psi}_{fde} \quad (12)$$

In this model, the interaction term is represented as a 4-valent vertex, where a field ψ is an incident half-edge decorated with the sign $+$ and a field $\bar{\psi}$ is an incident half-edge with the sign $-$. To represent the indices, it is customary to blow up the half-edges into three strands, one for each index, and then connect the strands according to the contraction pattern,

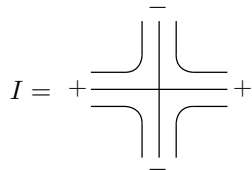

$$I = + \quad (13)$$

The $(0+1)$ -dimensional SYK-like action of the MO model writes:

$$S_{MO} = \int dt \left(i\bar{\psi}_{abc}\partial_t\psi_{abc} + \frac{\lambda}{2}\psi_{abc}\bar{\psi}_{ade}\psi_{fbc}\bar{\psi}_{fde} \right). \quad (14)$$

In the rest of this subsection we follow [8] and [9]. The propagator of this model is a 3-stranded edge which propagates each index of ϕ , connecting two half-edges of different signs. When arriving onto a sign $+$ at a vertex, we call the **left** strand the one which goes to the left, the **right** strand the one which goes to the right and the **straight** strand the one going straight. Those notions are preserved by the propagators so that it makes sense to define left, right and straight strands on the whole graph, denoted L, R, S respectively.

Denote by F the number of closed strands, $F = F_L + F_S + F_R$. The degree of the MO model for a connected graph with n vertices is

$$\omega_{MO} = 3 + \frac{3}{2}n - F. \quad (15)$$

Note that this formula is similar to the one obtained in the case of the CTKT model, except for the replacing of the faces of color 1, 2, 3 with closed strands of type L, R, S .

In fact, the MO model also has a notion of jackets. The jacket J_i is the 2-stranded graph obtained by deleting the type $i \in \{S, L, R\}$ strand. This leads to a similar formula as in the $O(N)^3$ -invariant cas, in term of the genus of the jackets:

$$\omega_{MO} = g_L + g_S + g_R. \quad (16)$$

Indeed, recall that a 2-stranded graph, also called a fat graph or a ribbon graph, represents a discrete surface whose faces are the interior of the closed strands and whose genus is given by Euler formula.

IV. RELATING MO GRAPHS TO $O(N)^3$ -INVARIANT GRAPHS

In this section we first recall the construction from [6] allowing to associate an $O(N)^3$ -invariant graph to any MO graph. The reciprocal proposition is not true - counter-examples are easily found and the class of $O(N)^3$ -invariant graphs is strictly larger than the class of MO graphs. We nevertheless give a sufficient condition under which the reciprocal holds. It can be formulated topologically, as a jacket being orientable, or combinatorially, as the genus being an integer.

Theorem 3. There is an explicit bijection between $O(N)^3$ -invariant graphs with a marked, orientable jacket and MO graphs supplemented with a color in $\{1, 2, 3\}$. This bijection maps bubbles to vertices and faces to closed strands.

Proof. We first build a map from MO graphs to a subset of $O(N)^3$ -invariant graphs. To do so, we identify the interaction of the MO model with a bubble of the $O(N)^3$ -invariant model in the following way

(17)

which induces the following correspondence

MO interaction	$O(N)^3$ -invariant bubble
Left strands	Edges of color 1
Right strands	Edges of color 2
Straight strands	Edges of color 3
Edges	Edges of color 0

Propagators then extends this correspondence to the whole graph, so that left strands become faces of color 1, right strands faces of color 2 and straight strands faces of color 3. If G is an MO graph, then denote \tilde{G} the corresponding $O(N)^3$ -invariant graph. Moreover if $i \in \{1, 2, 3\}$ is a color, define \tilde{G}_i by exchanging the colors i and 3 in \tilde{G} .

We now show that the jacket J_i in \tilde{G}_i is orientable. By definition, this is the same as J_3 being orientable in \tilde{G} . Due to the correspondence we have just described, this is in turn equivalent to the jacket J_S being orientable in G . The latter statement is now easily proved, as J_S in G is a 2-stranded graph obtained by removing all straight strands. This means that it is represented as a ribbon graph with 4-valent ribbon vertices and ribbon edges which do not twist the ribbons,

(18)

These local rules generate orientable surfaces, as recalled in Theorem 1. This means that J_i in \tilde{G}_i is orientable.

Next we invert the map starting from \tilde{G}_i an $O(N)^3$ -invariant graph with orientable, marked jacket J_i for $i \in \{1, 2, 3\}$. We exchange the color i with 3 and keep $i \in \{1, 2, 3\}$ as additional data for the MO graph G that we are going to get. We thus consider \tilde{G} an $O(N)^3$ -invariant graph whose jacket J_3 is orientable. The difficulty in inverting (17) is to find how the signs $+/-$ can appear.

This is obviously due to orientability of J_3 . The latter is an edge-colored graph, with colors $\{0, 1, 2\}$. As recalled in Theorem 2, its orientability is equivalent to the edge-colored graph being bipartite. The jacket J_3 is thus bipartite. We color its vertices, say, black and white. Since the vertices of G and J_3 are the same, one obtains a coloring of the

vertices of G (G is not bipartite however). One can then apply the following mapping

(19)

In other words, white/black vertices inherited from orientability become the $+/-$ signs we were looking for. Edges of color 0 connect white to black vertices in G . This implies that $+$ can only connect to $-$ and the other way around. This way, \tilde{G} is mapped to an MO graph G , with the color i of the marked jacket needing to be stored in addition with G . \square

V. DIAGRAMMATIC TECHNIQUES FOR $O(N)^3$ -INVARIANT GRAPHS

In this section we develop explicit diagrammatic techniques which we use to study the graphs of degrees 1 and $3/2$ of the $O(N)^3$ -invariant tensor model.

A. 2-edge-cuts

Consider G a 2-particle-reducible (2PR) graph, i.e. a graph with a 2-edge-cut: a pair of edges $\{e, e'\}$ of color 0 whose removal disconnects G ,

(20)

There is a natural flip operation which turns G into a pair of graphs,

(21)

by cutting e, e' into half-edges and gluing them as above.

The following proposition is well-known.

Proposition 1. With the above notations

$$\omega(G) = \omega(G_L) + \omega(G_R). \quad (22)$$

This is the additivity of the degree for 2PR graphs.

Proof. Recall that each edge of color 0 contributes to exactly one face of each color 1, 2, 3. Since G is 2PR, it is the same face of color i which goes along e and e' for all $i = 1, 2, 3$. However, there are different faces along e_1 and e_2 since they live in different connected components. One has:

$$F(G) = F(G_L) + F(G_R) - 3. \quad (23)$$

The result then follows from the formula (11) for the degree. \square

Therefore, if one is interested in finding all graphs at a fixed value ω of the degree, it is possible to distinguish the cases of 2PR and 2PI graphs. The 2PR graphs of degree ω are given by

- a 2PI graph of degree ω with insertions of 2-point graphs of vanishing degree ($\omega(G_R) = 0$). Any such 2-point graph is obtained by recursive insertions of a fundamental graph called the *melonic insertion*,

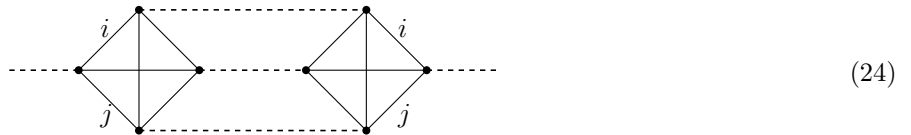

to be inserted on any edge of color 0.

- G_L and G_R both have degrees less than ω .

B. Dipole removals

Dipoles were introduced in [10] to facilitate the analysis of graphs at fixed degree in the MO model. Here we adapt the notion to the $O(N)^3$ -invariant model. Just as in [10], dipoles are defined as the minimal subgraphs which have an internal face of length two. There are no dipoles with a single bubbles. With two bubbles, one has three types of dipoles:

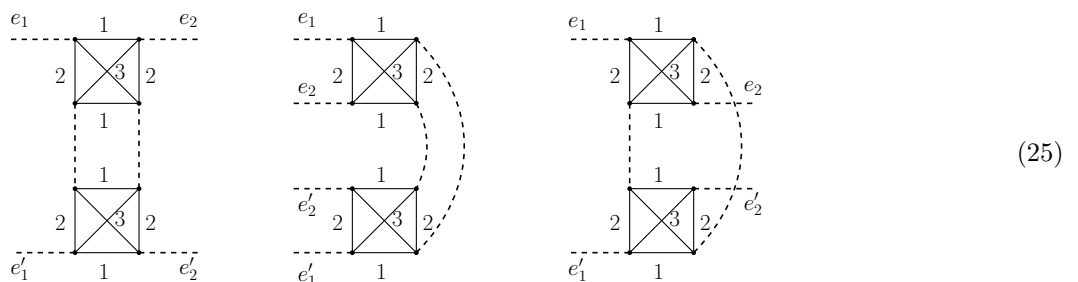

We label them with the color of their internal face of length 2: the left one has color 1, the middle one has color 2 and the right one has color 3.

If a 2PI graph contains a dipole, it can be removed while preserving connectedness³

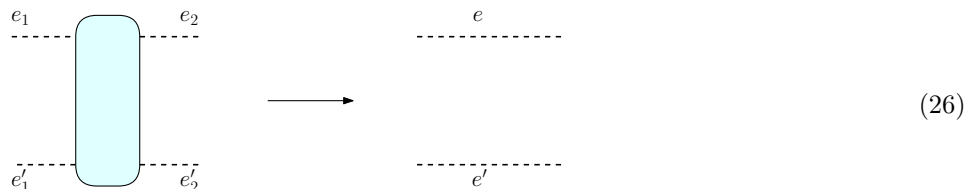

Proposition 2. There are four types of dipole removals, which are described in the proof below. Three of them decrease the degree, by 4, 2 or 1, and the other one does not change it.

Proof. Let us calculate the variation of the degree. Without loss of generality, we consider the removal of a dipole of color 1. The new graph G' has two bubbles less. It also loses a face of color 1. As for the faces of color 2 and 3, it

³ If $\{e_1, e_2\}$ (or $\{e'_1, e'_2\}$) forms a 2-edge-cut, then the dipole removal disconnects the graph.

depends on their paths in G . Up to symmetry, there are the following four possibilities

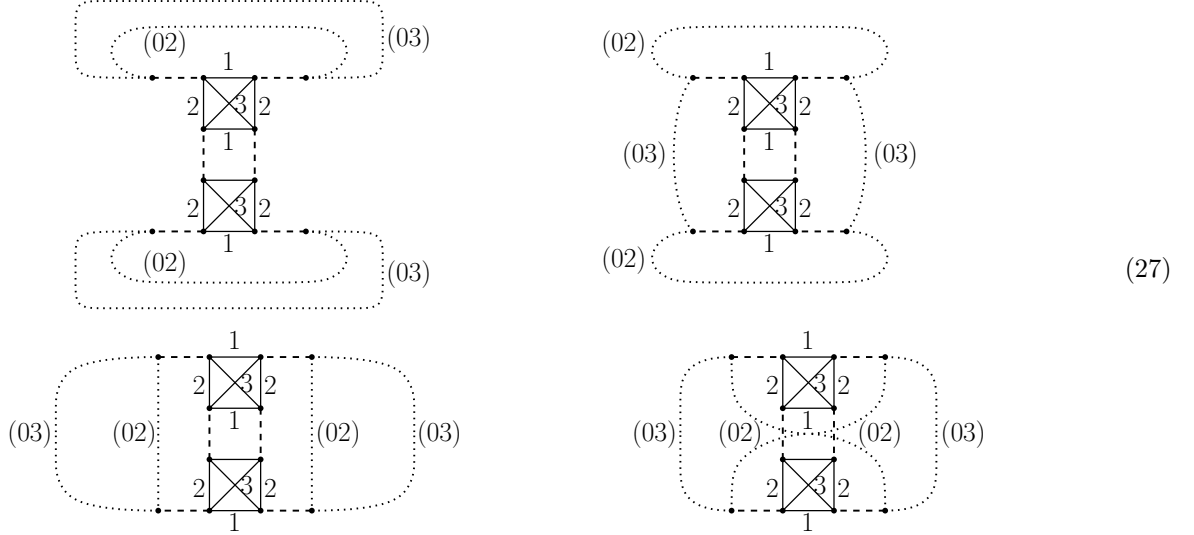

Here the colored lines do not represent edges but instead the paths of the faces, i.e. bicolored cycles with alternating colors 0 and i , which go along the bubbles of the dipole. Denote by $\epsilon_2, \epsilon_3 \in \{1, 2\}$ the number of faces of color 2 and 3 in G which go along the dipole, and by ϵ'_2, ϵ'_3 the number of those faces left in G' .

- In the first case (top left), $\epsilon_2 = \epsilon_3 = 1$. Then each of those faces gets split into two⁴ in G' , i.e. $\epsilon'_2 = \epsilon'_3 = 2$. One has:

$$\begin{aligned} \omega(G') &= 3 + \frac{3}{2}(n(G) - 2) - (F_1(G) - 1 + F_2(G) + 1 + F_3(G) + 1) \\ &= \omega(G) - 4. \end{aligned} \quad (28)$$

In particular, since the degree is positive, it means that $\omega(G) \geq 4$.

- In the second case (top right), $\epsilon_2 = 1$ and $\epsilon_3 = 2$. The face of color 2 is split into two in G' while those of color 3 are merged, i.e. $\epsilon'_2 = 2$ and $\epsilon'_3 = 1$. Therefore the number of faces of color 2 and 2 is globally unchanged and

$$\begin{aligned} \omega(G') &= 3 + \frac{3}{2}(n(G) - 2) - (F_1(G) - 1 + F_2(G) + 1 + F_3(G) - 1) \\ &= \omega(G) - 2. \end{aligned} \quad (29)$$

In particular, since the degree is positive, it means that $\omega(G) \geq 2$.

- In the third case (bottom left), $\epsilon_2 = \epsilon_3 = 2$, and for both colors the two faces are merged into one in G' , leaving $\epsilon'_2 = \epsilon'_3 = 1$ and

$$\begin{aligned} \omega(G') &= 3 + \frac{3}{2}(n(G) - 2) - (F_1(G) - 1 + F_2(G) - 1 + F_3(G) - 1) \\ &= \omega(G), \end{aligned} \quad (30)$$

i.e. the degree is unchanged by the dipole removal.

- In the fourth case (bottom right), $\epsilon_2 = 1$ and $\epsilon_3 = 2$. However, in contrast with the previous cases, the face of color 2 is not split into two, i.e. $F_2(G) = F_2(G')$. The two faces of color 3 are merged into one, so $\epsilon'_2 = \epsilon'_3 = 1$. This leads to

$$\begin{aligned} \omega(G') &= 3 + \frac{3}{2}(n(G) - 2) - (F_1(G) - 1 + F_2(G) + F_3(G) - 1) \\ &= \omega(G) - 1, \end{aligned} \quad (31)$$

This concludes the proof. □

⁴ Notice that our drawing becomes disconnected after the removal, but this is misrepresentation due to the fact that our drawing does not contain other edges which would leave G' connected.

C. Dipole insertions

One can consider the reverse operation: the dipole insertion on the edges e and e' . By inspecting the above proof, one finds the following lemma which provides a necessary condition for a dipole insertion not to increase the degree by more than 1.

Lemma 1. A dipole insertion on $\{e, e'\}$ which increases the degree by 1 or preserves it, requires that there are two colors $\{i, j\} \subset \{1, 2, 3\}$ such that the face of color i along e also goes along e' , and similarly for j .

Proof. A variation of the degree of at most 1 corresponds to the third and fourth cases of the above proof. After the dipole removals in those cases, the edges e and e' have two colors (2 and 3 in our pictures) for which the same face goes along e and e' . \square

We recall that melonic insertions do not change the degree of a graph. It is thus common, in order to analyze the degree, to remove at first all melonic 2-point functions, and then add the full, melonic 2-point function on all edges of color 0 at the end of the analysis. For instance, here we will aim at identifying all graphs of degree 1 so that we can try and identify all melon-free graphs for degree 1 and then add all melonic decorations on the edges of color 0. However, since we also consider dipole removals and insertions, the question arises as to whether new dipole insertions which change the degree by at most 1 would be allowed after melonic insertions. The following lemma answers this question.

Lemma 2. Let G' be obtained from G by a melonic insertion on the edge e . Then there exists a possible dipole insertion preserving the degree on the pair $\{e', e''\}$ in G iff it exists in G' , for $e', e'' \neq e$.

This means that melonic insertions do not “offer” new dipole insertions which preserve the degree or increase it by one.

Proof. Let G be a graph and G' obtained by a melonic insertion on e ,

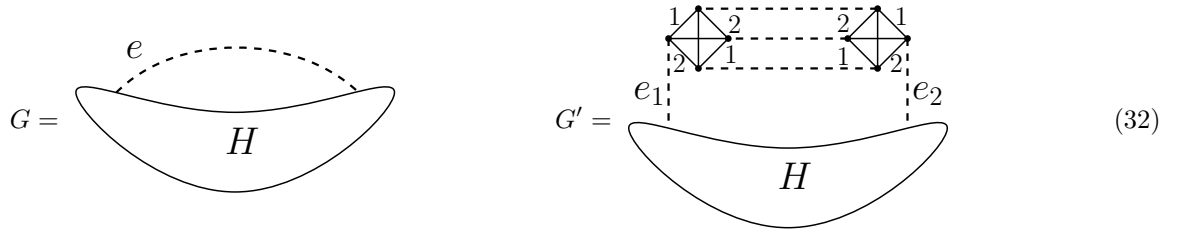

To investigate the insertion of dipoles which increase the degree by one or preserve it, we use Lemma 1 and consider the pairs of edges of color 0 $\{e', e''\}$ such that there are two colors for which the faces going along e' and e'' are the same. Also denote \tilde{G} the graph obtained from G by performing the dipole insertion on $\{e', e''\}$.

If e' and e'' lie in H in G , that is also the case in G' so that the same dipole insertion can be made before or after the melonic insertion.

If $e' = e$ (or $e'' = e$), then the corresponding dipole insertion gives rise to two possible insertions in G' , one with e_1 and e'' , the other with e_2 and e'' . In fact, the resulting graphs only differ by the position of the melonic insertion in \tilde{G} , so the melonic insertion does not provide new dipole insertions.

All the faces going along e_1 also go along e_2 so that it seems that a new dipole insertion is possible. However, because e_1 and e_2 share three faces instead of two, the dipole insertion is in fact a melonic insertion.

Finally, it is easy to check that for each of the three edges of color 0 connecting the bubbles of the melonic insertions, there are no other edges which would share at least two faces with it. Therefore, there is no possible dipole insertion which preserves the degree or change it by one. \square

D. Chains of dipoles

A chain of dipoles is a sequence of dipoles of arbitrary length. Such a chain can be of fixed color,

(33)

or it can have multiple colors, in which case we use the same box diagram without any color label.

- Lemma 3.**
1. If there is a pair $\{e, e'\}$ in G where a dipole of color i can be inserted without changing the degree, then a chain of color i can be inserted without changing the degree.
 2. If, in addition, a dipole of a different color can also be inserted without changing the degree, then any chain can be inserted without changing the degree.

Proof. Without loss of generality, let $i = 1$. Inserting a dipole without changing the degree means that we are in the third case of Proposition 2, see (27). There, the paths of the faces of color 2 and 3 had been drawn, but not those of color 1. There are two possible paths for the faces of color i going along e and e' : they are either different, or the same faces.

(34)

In the first case, the edges e_1 and e'_1 share their faces of color 2 and 3, meaning that indeed a new dipole of color 1 can be inserted without changing the degree. However, a dipole of another color would change the degree because the faces of color 1 going along e_1 and e'_1 are different but would be merged after a dipole insertion of color 2 or 3.

In the second case, e_1 and e'_1 share their 3 faces so that any dipole insertions can be performed without changing the degree. □

Chains of dipoles are related to melonic graphs in the following way. If one opens up a melonic subgraph by cutting an edge of color 0, this creates a chain of dipoles. The following lemma is useful to glue two graphs along a 2-edge-cut as in Section V A.

Lemma 4. If G has the form

(35)

where the square represents an arbitrary melonic 2-point function, then cutting an arbitrary edge of color 0 within this 2-point function results in a 2-point graph of the form

(36)

where the square inside the chain means that all edges of color 0 can have melonic 2-point function insertions.

Proof. Let e be the edge of color 0 which is cut. By definition of melonic 2-point functions, the most generic situation (up to color relabeling of each bubble) is like

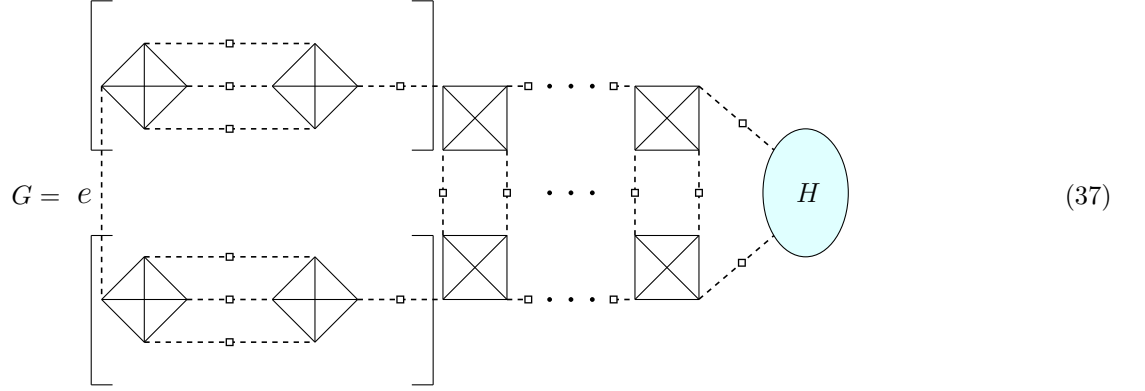

where the parts between brackets may be empty in which case e is extended and the three dots indicate potential dipole repetitions. Cutting the edge e leads to the expected result. \square

E. Face length

In this section we gather some simple results on the faces of $O(N)^3$ -invariant graphs.

Lemma 5. If G has degree ω , n bubbles and jackets J_i of genus g_i , then

$$F_i = 1 - \omega + 2g_i + \frac{n}{2}. \tag{38}$$

The degree is usually given in the literature in terms of the number of faces. Here we have an inverse, simple relation.

Proof. Recall that jackets are defined such that there are as many jackets as colors. As it turns out, the linear system made of the three equations (9) can be inverted to get an expression for the number of faces of a given color in terms of the Euler characteristics of the jackets,

$$F_i = \frac{1}{2}(\chi_j + \chi_k - \chi_i + n). \tag{39}$$

Using the definition of the degree $\omega = \sum g_i$, leads to identity (38), which concludes the proof. \square

A standard method in the analysis of colored graphs is to analyze the length of faces.

- A face of length one is equivalent to a tadpole, *i.e.* the subgraph



for any color assignment. Then the graph is 2PR and after performing the flip as in (20), (21), we have $G_R = \text{circle with X inside}$ which has degree 1/2 and

$$\omega(G) = \omega(G_L) + 1/2. \tag{41}$$

There are obviously no tadpoles in 2PI graphs.

- A face of length 2 is part of dipole (see the definition of dipoles above)

We can thus focus on 2PI, dipole-free graphs, which in particular only have faces of length greater than or equal to three.

Lemma 6. If G is 2PI and dipole-free, then

$$\sum_{l \geq 5} (l - 4) F_{i,l} = F_{i,3} + 4(\omega - 2g_i - 1) \quad (42)$$

where $F_{i,l}$ is the number of faces of color i and length l .

Proof. By noticing that each edge of color 0 contributes to exactly one face of each color, and that there are $2n$ such edges, one obtains

$$\sum_{l \leq 1} l F_{i,l} = 2n. \quad (43)$$

Here $F_{i,l}$ is the number of faces of color i and length l , and n is the number of bubbles of the graph. Combining equations (38) and (43), the number of bubbles can be eliminated,

$$\sum_{l \leq 1} (l - 4) F_{i,l} = 4(\omega - 2g_i - 1). \quad (44)$$

Restricting this equation to 2PI, dipole-free graphs implies that $l \geq 3$. The term $l = 3$ in the sum is in fact the only term with a negative sign in the left hand side and we extract it to move it to the right hand side. \square

If a jacket is orientable, one has the following property:

Lemma 7. If G has its jacket J_i orientable, then its faces of color i are of even length, for $i \in \{1, 2, 3\}$.

Proof. Without loss of generality, assume $i = 3$. As already noticed in the proof of Theorem 3, when J_3 is orientable, there is a coloring of the vertices of G such that J_3 is bipartite. G itself is not bipartite since the edges of color 3 connect white vertices to white vertices and black vertices to black vertices,

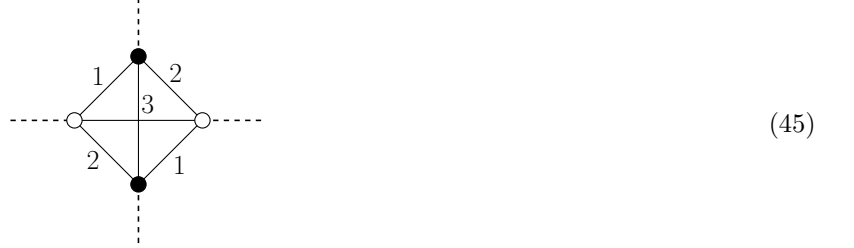

The edges of color 0 (here dashed) then connect white to black and black to white vertices. We conclude that the faces of color 3 have even lengths. \square

With the different operations described above, we will list in the following sections all the graphs of degree 1 and $3/2$. For each degree, we first give the graphs that can be obtained through composition of smaller degree graphs. Then we give all the 2PI graphs with no melons nor tadpoles, and finally we study the possible dipole insertions. Our proof relies on degree 0 and degree $1/2$ $O(N)^3$ -invariant graphs.

F. The strategy

To identify all graphs at a given degree ω , we propose the following strategy.

1. Consider all graphs up to melonic 2-point functions on edges of color 0, since they leave the degree invariant.
2. Put aside the 2PR graphs of degree ω . They are indeed obtained by composing two graphs G_L, G_R of smaller degree and such that $\omega(G_L) + \omega(G_R) = \omega$. This leaves the 2PI graphs to be determined.
3. Find all 2PI, dipole-free graphs of degree ω .
4. Consider all (chains of) dipole insertions which preserve the degree on the graphs found above of degree ω , and (chains of) dipole insertions on graphs of smaller degrees which bring it up to ω . Then consider dipole insertions on the newly found graphs, and so on iteratively.

5. Finally, an induction on the number of bubbles allows to conclude. This last step is necessary because of the iterative nature of the previous step.

Notice that the steps 2 and 4 are “automatic”: they rely on simple operations (composition forming a 2-edge-cut, and dipole insertions) to be performed on graphs already known and can be in practice automated. Only step 3 requires an independent analysis, which has to be performed ”by hand”.

VI. DEGREE 0 AND 1/2 GRAPHS OF THE $O(N)^3$ -INVARIANT TENSOR MODEL

The degree 0 and respectively 1/2 graphs of the $O(N)^3$ -invariant model are the melonic graphs and tadpoles (see [6] for details). Melonic graphs are obtained by recursive melonic insertions, i.e. insertions of the 2-point graph (24), starting from the 2-bubble graph



which is invariant under color permutations.

The graphs of degree 1/2 are obtained by recursive insertions of the same 2-point graph (24) starting with the double-tadpole



Notice that there are 3 different double-tadpoles, depending on the color i of the two faces of length one.

VII. DEGREE 1 GRAPHS OF THE $O(N)$ INVARIANT SYK-LIKE TENSOR MODEL

In this section we focus on the $\omega = 1$ case and apply the strategy proposed in subsection V F. We thus find all the Feynman graphs of degree 1 of the $O(N)^3$ -invariant SYK-like tensor model. Notice that this also gives all the graphs of the MO model.

As already emphasized, the only non-automatic step of our strategy is Step 3 whose goal is to obtain the 2PI, dipole-free graphs of degree 1. This is what we start with, in subsection VII A. We then go directly to Step 5 since all the other steps are automatic, in subsection VII B.

A. 2PI, dipole-free graph of degree 1

Theorem 4. There is an unique 2PI, dipole-free, $O(N)^3$ -invariant graph of degree 1, given below

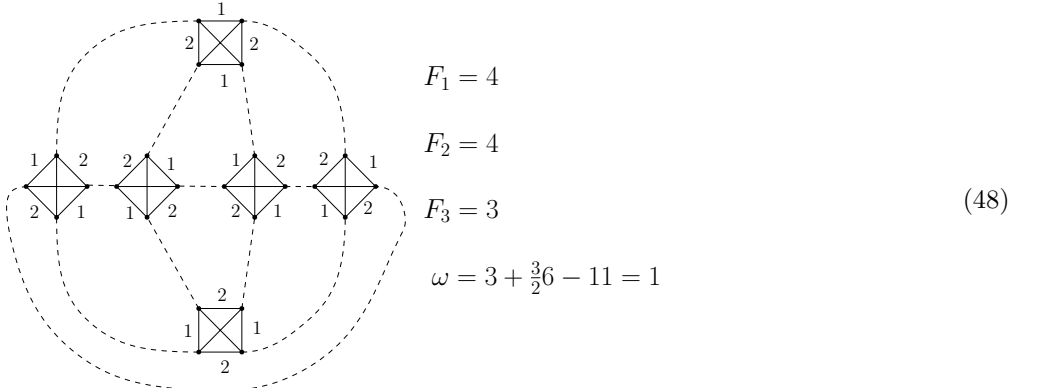

Proof. Let G be a 2PI graph of degree 1 with no dipoles and with n bubbles. Considering (10), the genera of its three jackets are either $(g_1, g_2, g_3) = (0, \frac{1}{2}, \frac{1}{2})$ or $(g_1, g_2, g_3) = (0, 0, 1)$ up to color permutations. In both cases, G has a planar jacket which we assume, without loss of generality, to be J_3 , hence $g_3 = 0$.

Since J_3 is planar, it is bipartite and thus admits a canonical embedding described in Remark 1, obtained by using the counter-clockwise orientation for the colors (012) around white vertices, and clockwise around black vertices. This in turn provides a canonical embedding for G itself, obtained by adding the edges of color 3 at the corners between the colors 1 and 2. We use this representation in the remaining of the proof.

Moreover, among the two other jackets, at least one, say J_1 , has non-zero genus, i.e. $g_1 > 0$. Using equation (42) with $\omega = 1$, we find:

$$F_{1,3} = 8g_1 + \sum_{l \geq 5} (l - 4) F_{1,l} > 0. \tag{49}$$

Let us thus focus on a face of color 1 in G ,

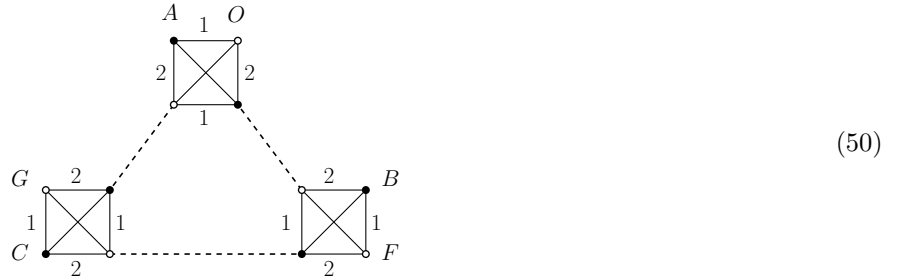

where the letters label vertices.

To complete the graph, we need to investigate the faces of color 3. Lemma 7 applies to J_3 : the faces of G of color 3 are of even lengths. Since G is 2PI, it has no tadpoles, so no faces of length 1, and since it is dipole-free, it also has no faces of length 2. The faces of color 3 thus have length at least 4. Equation (42) with $g_3 = 0$ and $\omega = 1$ becomes

$$\sum_{l \geq 5} (l - 4) F_{3,l} = 0, \tag{51}$$

meaning that all the faces of color 3 of G have to be of length exactly 4. We will thus complete G so that all its faces of color 3 have length 4.

Consider the face of color 3 going through the vertex O and recall that edges of color 0 only connect black to white vertices. If O is connected to A , a tadpole would be created which is forbidden. If O is connected B , a dipole would be formed, which is also forbidden, and similarly for C . The vertex O must therefore be connected to a vertex of another bubble

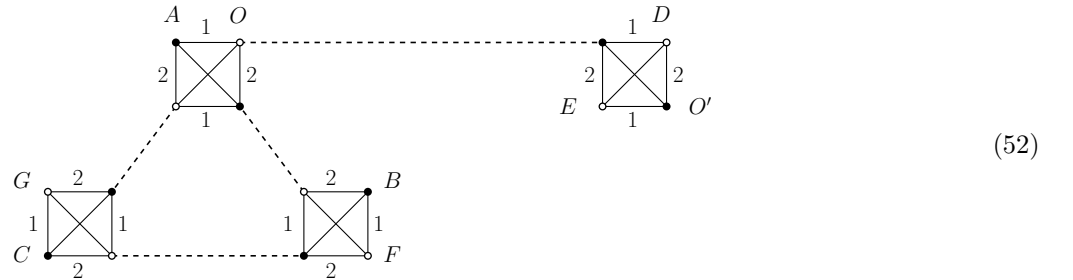

The vertex O' cannot be connected to D or E because this would create tadpoles. It cannot connect to F or G

because the face would have length greater than 4. Therefore O' must be connected to another bubble

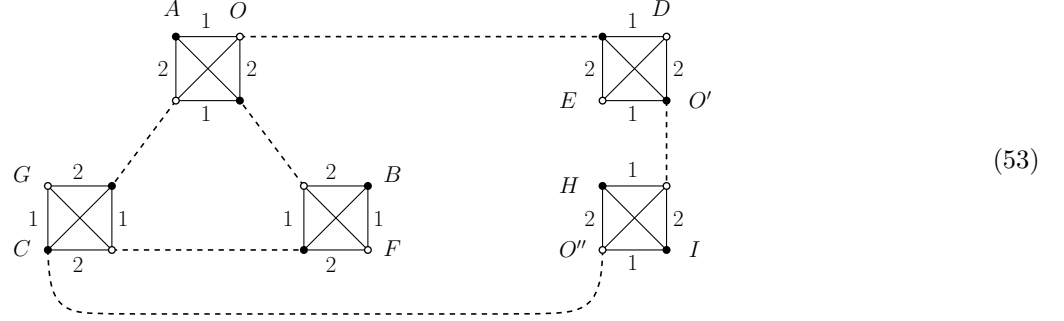

where the connection of O'' to C is forced to get a face of length 4.

Let us now consider the face of color 3 going through A and F . First, assume that face connects to a new bubble and let us prove that this cannot be true. Planarity of J_3 requires the new bubble to lie in the same region as follows

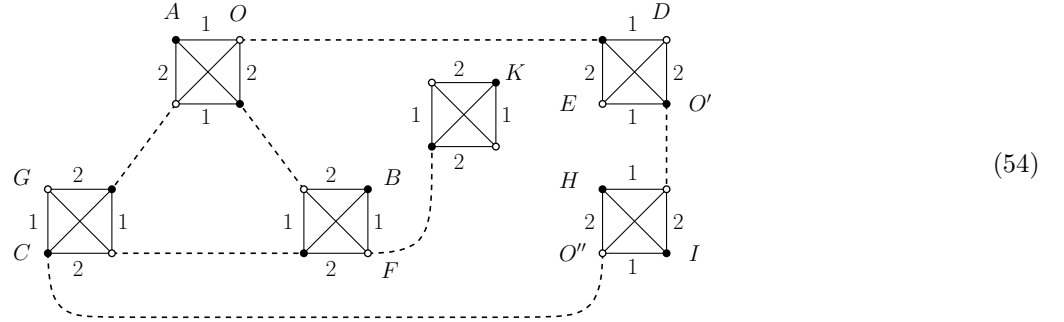

Again K cannot be connected to the white vertices of its bubbles as that would create tadpoles. If it is connected to E , this then forces an edge of color 0 from D to A so that the face be of length 4, but this creates a dipole. Any other connection would be non-planar for J_3 , except if K is connected to another new bubble. However, it is then easy to check that this new bubble would have to be connected to A to close the face at length 4 and that would be non-planar.

The only possibility is thus that F is connected to H instead. Then the vertex I cannot however be connected to the vertices D or G without creating a dipole. This requires I to be connected to a new bubble,

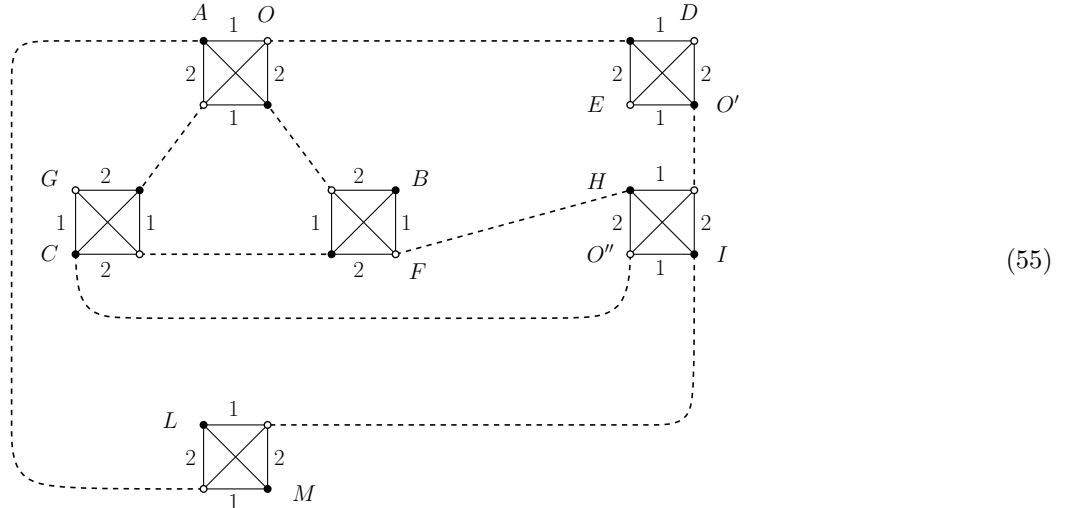

which is in turn connected to A to close the face of color 3 at length 4.

Finally, consider the face of color 3 going through G and B . We explained above that F could no be connected to a new bubble. The same reasoning applies to B , as can be checked directly, so that it has to be connected to E . Then we must create a path with two edges of color 0 and one edge of color 3 between D and G . It is straightforward to check that if D connects to a new bubble then one has to break planarity of J_3 to close the face. Eventually, the only possibility is to connect D to M and L to G . This is the graph given in the theorem. \square

B. The graphs of degree 1

Theorem 5. The graphs of degree 1 are the graph given in (48) and the following graphs

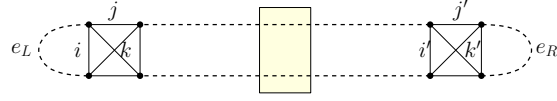
(56)

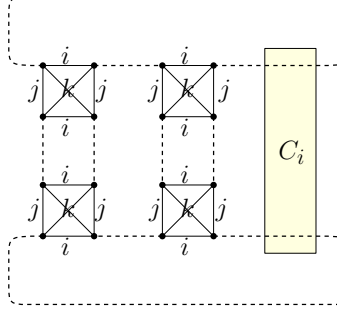
(57)

In this Theorem, dashed edges represent **any melonic 2-point function**, including in (48), and the boxes represent possibly empty chains of dipoles.

We have drawn explicitly two dipoles of color i in (57) so that when the chain C_i is empty the graph has 4 bubbles and is indeed of degree 1 (if it had only two bubbles it would be melonic).

Proof. We use an induction on the number of bubbles.

a. Case G 2PR. Then we perform the flip as in (21) which turns G into the pair $\{G_L, G_R\}$ such that $\omega(G) = \omega(G_L) + \omega(G_R)$.

- If G_L (or G_R) has vanishing degree, the other graph has degree 1 and fewer bubbles so we can apply the induction hypothesis. The graph G_L is melonic and we find that G is according to the theorem upon re-inserting G_L .
- If $\omega(G_L) = \omega(G_R) = 1/2$, then they are described by (47): double tadpoles with arbitrary melonic insertions on the edges of color 0. The graph G is then a composition of G_L and G_R . From Lemma 4 it is easy to see that this gives rise to the family (56).

All the other cases correspond to G being 2PI.

b. Case G 2PI and dipole-free. Then G is exactly the graph (48).

c. Case G 2PI with a dipole. Then the dipole can be eliminated as in (26) leading to G' connected, with two bubbles less than G . As seen in Proposition 2, dipole removals decrease or preserve the degree. Since G has degree 1, only the third and fourth cases of the proof of Theorem 2 may appear. They are the cases where the Lemma 1 and Lemma 2 apply.

- If the dipole insertion decreases the degree by 1, then G' is melonic. It is thus obtained by melonic insertions on the 2-bubble graph (46). From Lemma 2, we can study the dipole insertions directly on (46). Then, for any pair of edges of color 0 in (46), it is easy to check that a dipole insertion is in fact a melonic insertion, which in particular preserves the degree.
- Therefore the dipole removal from G must preserves the degree: $\omega(G') = 1$. From the induction hypothesis, G' has the form given in the theorem. The last step of the proof is thus to verify that performing a dipole insertion which preserves the degree on any of those graphs does not create a graph which is not already in this family. Using Lemma 2, we can consider the three types of graphs of the theorem without any melonic 2-point graph.

– G' has the form (56). First consider the cases with only two bubbles. There are two of them, starting with

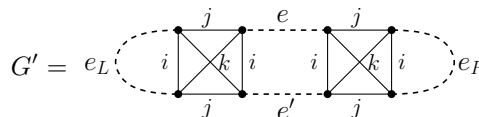
(58)

where the same faces of color j and k go along e_L and e_R . Then a dipole insertion which preserves the degree can be performed on these two edges and leads to the graph (57) with four bubbles, i.e.

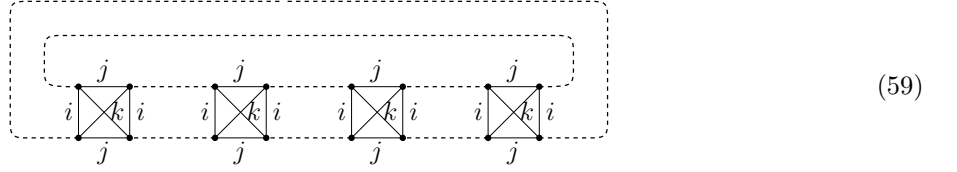

The other case is

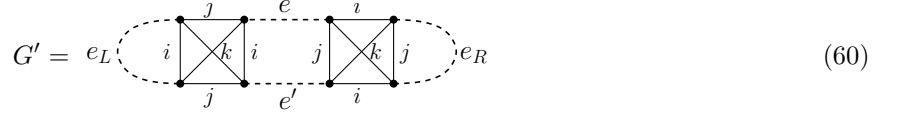

where no dipole insertion preserving the degree can be done on e_L, e_R this time. However, both in (58) and (60), the edges e and e' have in common their faces of each color and a dipole of any color can be inserted without changing the degree. This leads to a graph such as (56), with four bubbles.

Consider now a graph (56) with a non-empty chain. The dipole in position l has color j_l ,

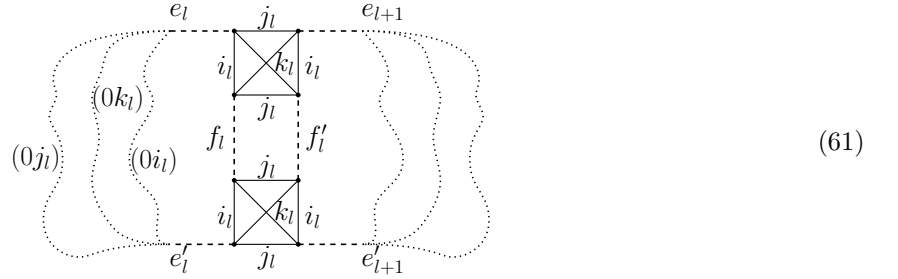

The dotted lines represent the bicolor paths which close the faces of each color going along $e_l, e_{l+1}, e'_l, e'_{l+1}$. There can be dipole insertions which preserve the degree on the pair $\{e_l, e'_l\}$ and on the pair $\{e_{l+1}, e'_{l+1}\}$, both resulting in lengthening the chain of dipoles. These dipole insertions can be of any color. Notice that the dotted paths on the left are disjoint from those on the right. This implies that no other dipole insertions preserving the degree can be done.

- The graph G' has the form (57). First, it can be the graph with four bubbles pictured in (59). Only one dipole preserving the degree can be inserted, of color i

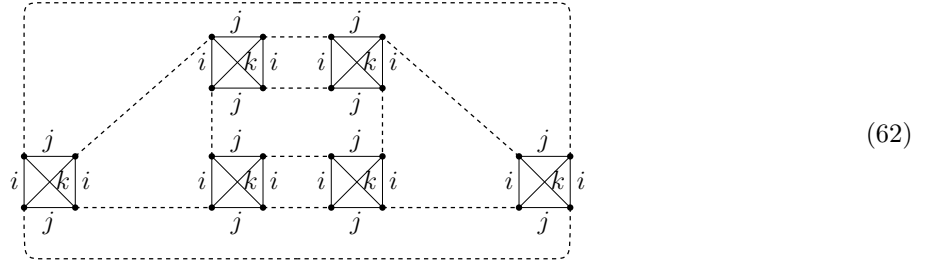

One can then add dipoles of color i to create a chain of dipoles. This corresponds to (57).

No other dipole preserving the degree can be inserted. Indeed, a dipole of the chain is of the type

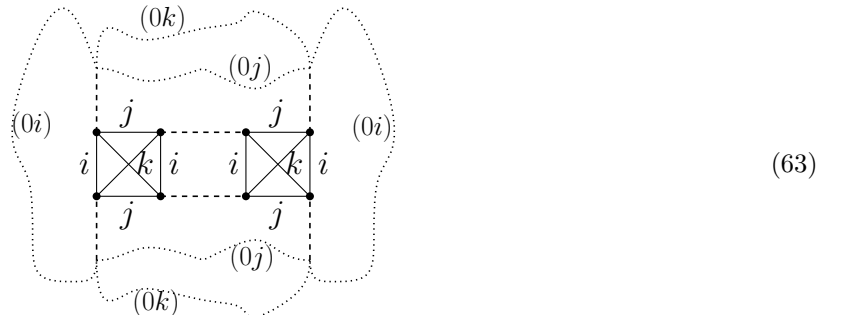

where the dotted lines represent the bicolored paths closing the faces. Those paths are disjoint and therefore only dipoles of color i extending the chain are allowed.

- The graph G' can be the graph (48). It can be checked directly that no two edges have more than one face in common, meaning that no dipole insertion preserving the degree exists.

This ends the induction and thus concludes the proof. \square

VIII. DEGREE $3/2$ GRAPHS OF THE $O(N)^3$ -INVARIANT SYK-LIKE TENSOR MODEL

Our strategy can be applied to graphs of higher degrees, provided one can identify the 2PI, dipole-free graphs (step 3 of the strategy in Section VF). We do so in the case of degree $\omega = 3/2$ below. The other steps of the strategy are briefly discussed at the end of the section and are left to be completed by the interested reader.

Theorem 6. There is an unique $O(N)^3$ -invariant, dipole-free, 2PI graph of degree $3/2$ which is

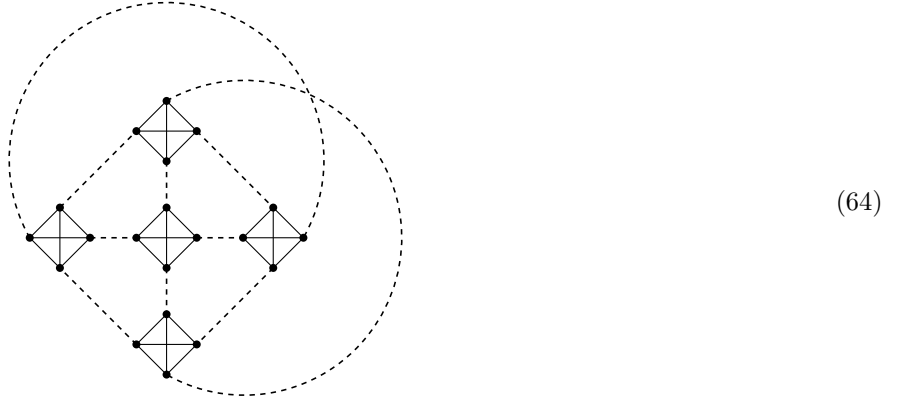

Its three jackets have genus $1/2$ (topological projective planes). For each color, there are exactly 2 faces of length three and one of length four.

Proof. Let G be a graph of degree $3/2$. *A priori*, its jackets can have genera

$$(g_1, g_2, g_3) = (3/2, 0, 0) \quad \text{or} \quad (g_1, g_2, g_3) = (1, 1/2, 0) \quad \text{or} \quad (g_1, g_2, g_3) = (1/2, 1/2, 1/2) \quad (65)$$

up to color permutations. The first two cases have at least one planar jacket, while the third case has not. We first show that the jackets cannot be planar.

a. Assume one jacket is planar, say J_3 . From Lemma 7, the faces of color 3 have even lengths, $F_{3,2l+1} = 0$. This in turn simplifies (42) to

$$\sum_{l \geq 2} (l - 2) F_{3,2l} = 1, \quad (66)$$

further implying that there is one face of length 6, all others being of length 4.

It can be checked that the face of length 6 has to have six distinct bubbles. For instance, we investigate the cases where it has only five bubbles. It could be as follows

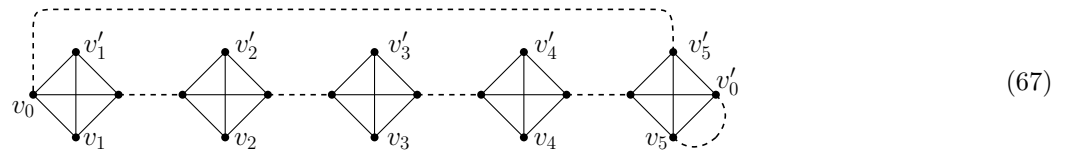

where v_0 is connected v_0' , but then it forces a face of length 1 on the color 1 or 2 and G would be 2PR.

If v_0 is connected to v'_4 , then the planarity of J_3 forces v_5 to be connected to a 1-point function, and v'_1, v'_2, v'_3 to a 3-point function,

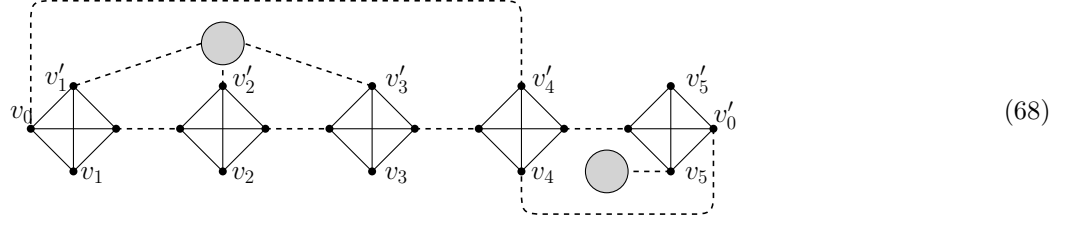

but they do not exist since the number of vertices is always even (no odd-point functions).

If v_0 is connected to v'_3 , then planarity of J_3 forces the edges of color 0 connected to v_4 and v_5 to form a 2-cut, making G 2PR, or to connect v_4 to v_5 by a single edge of color 0 which then forms a dipole and this is forbidden as well,

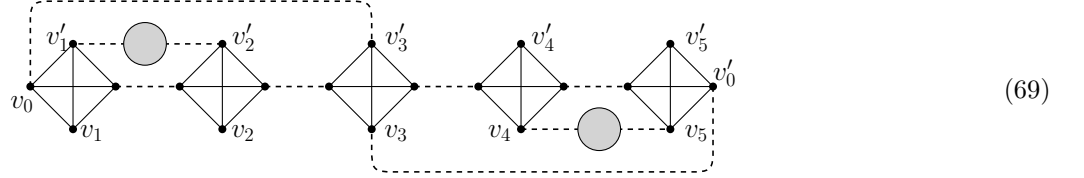

(and similarly between v'_1 and v'_2).

Let us thus denote b_1, \dots, b_6 the six distinct bubbles forming a face of color 3 and length 6. The other edges of color 3 of those bubbles must belong to faces of length 4. The same arguments as those used just above to prove that the bubbles are distinct can be used to prove that the vertex v_1 of b_1 cannot be connected to a vertex of b_2, \dots, b_6 . It therefore connects to another bubble b_7 , and by symmetry v'_1 too, to b_8 . A face of length 4 is then obtained by “crossing” one of the bubbles b_2, \dots, b_6 . Say it crosses b_3 ,

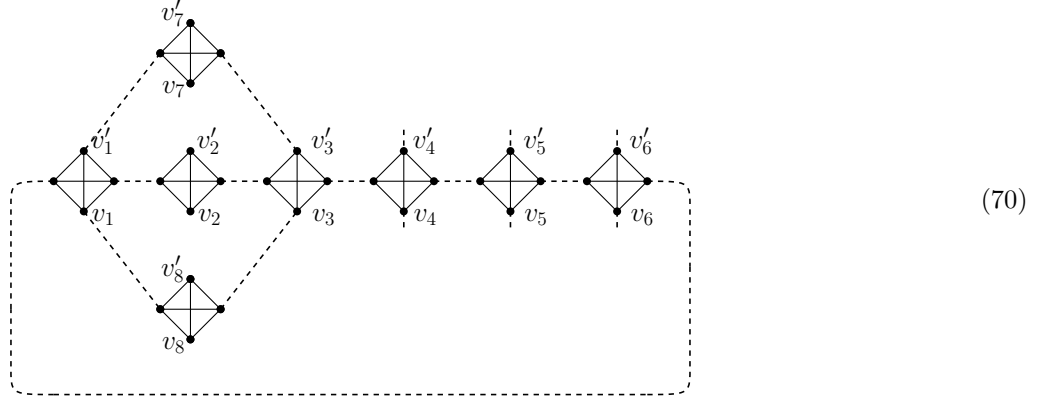

then planarity of J_3 forces a 2-point function between v'_2 and v_7 , and G being 2PI forces this 2-point function to be trivial, i.e. a single edge of color 0. Same thing between v_2 and v'_8 . The face of color 3 going along those edges must be of length 4 too. To do that, it is necessary to cross one of the bubbles b_4, b_5 or b_6 . In the case it crosses b_4

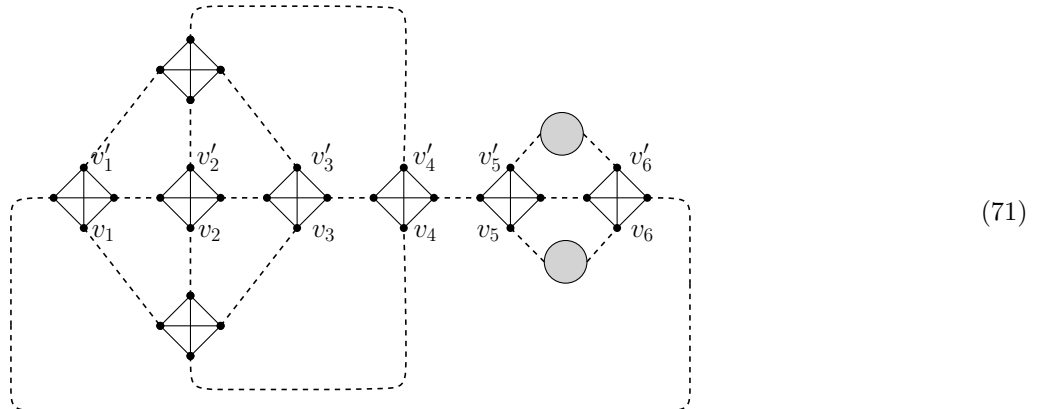

Planarity of J_3 again forces a 2-point function between v_5 and v_6 , making G 2PR, or directly an edge of color 0 creating a dipole. If the face of color 3 going through v_2 and v'_2 crosses b_6 , this is similar. If it crosses b_5 instead, planarity of J_3 would force 1-point function connected to v_4 and v'_4 , which is impossible.

All other cases are treated similarly. The conclusion is that G 2PI, dipole-free, of degree 3/2, cannot have a planar jacket.

b. All jackets therefore have genus 1/2. We can thus embed any jacket into the projective plane without crossings. Adding the edges of the missing color to the jacket, an embedding of G is obtained. As a convention, we will consider that J_3 is embedded without crossings, and the projective plane is represented as a disc with opposite points identified.

Next thing is to study the face lengths. From Lemma 6, one finds

$$F_{i,3} = 2 + \sum_{l \geq 5} (l - 4)F_{i,l} \geq 2 \tag{72}$$

meaning that there are at least two faces of length 3 for each color.

c. The faces of length 3. Consider a face of length 3 and color 3 and try to represent it using the embedding. It might be like



where the interior regions must then have a 3-point function which is impossible. Therefore a face of length 3 and color 3 must follow the (unique up to homotopy) non-contractible cycle of the projective plane like

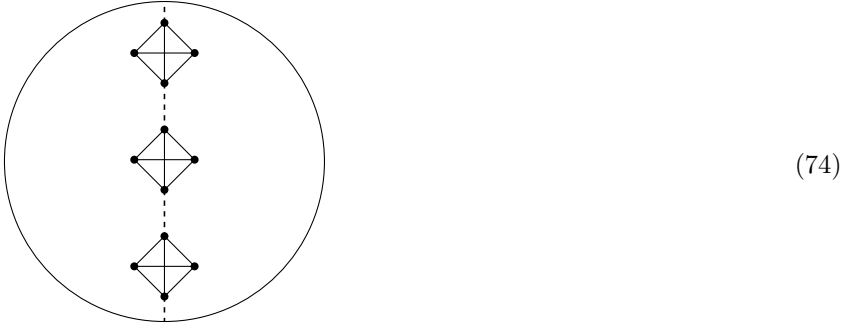

We can then study the location of a second face of length 3 and color 3. It must obviously also wrap around the non-contractible cycle and must therefore “cross” the previous face. This gives

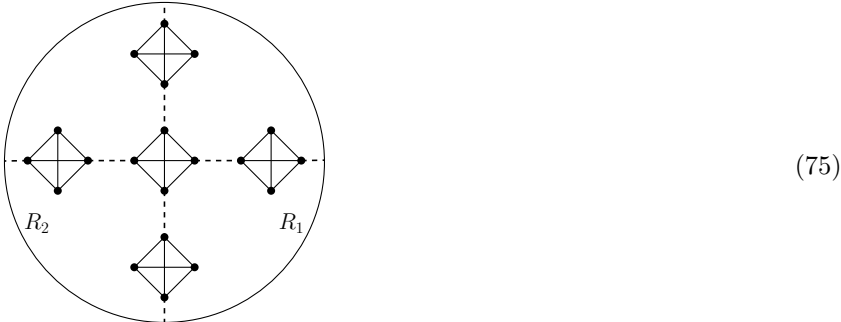

In J_3 , the exterior of the bubbles consists in two regions R_1 and R_2 . A third face of color 3 and length 3 would have to go through both regions and thus be like

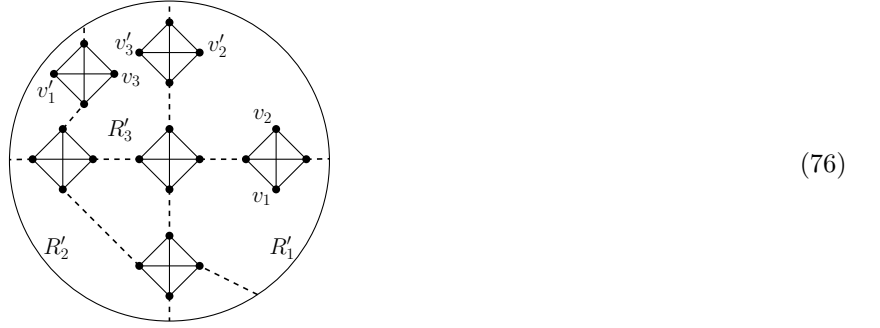

The only unpaired vertices in the region R'_1 are v_1 and v'_1 . Only a 2-point function can thus connect them and it in fact has to be just an edge of color 0 for G to be 2PI. For the same reason, v_2 and v'_2 must be connected by an edge of color 0, as well as v_3 and v'_3 . All vertices are then adjacent to edges of color 0. However the counting of faces reveals that this graph is of degree 1 (its jacket J_2 is planar). We conclude that there are only two faces of color 3 and length 3. The other faces of color 3 are thus all of length 4.

d. The faces of length 4. Consider one, denoted f , going through one of the bubbles already drawn in (75). It has to go through the two regions R_1 and R_2 and must therefore go through at least two of the bubbles already drawn.

Say it goes through v_1 and v'_2 , with new notations depicted below, with an additional bubble between them. Then the vertex v of the new bubble lies in a region with no other unpaired vertex, so it has to connect to a 1-point function which is zero,

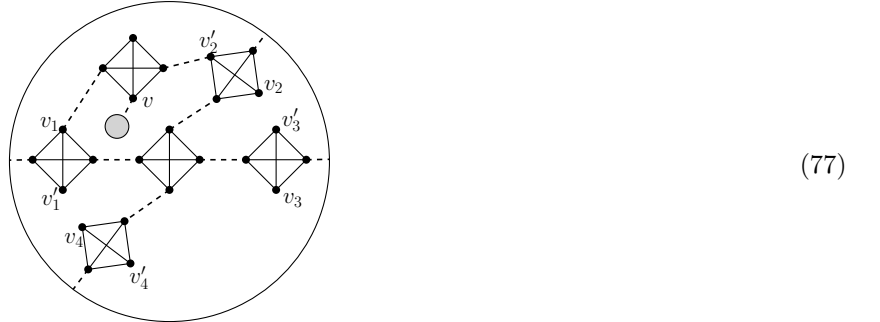

Similarly, if there are two new bubbles between v_1 and v'_2 , then their vertices must form a non-trivial 2-point function or a dipole, which are both forbidden. It goes similarly if one tries to add a bubble between v_1 and v_3 with a path of colors 0 and 3 between them,

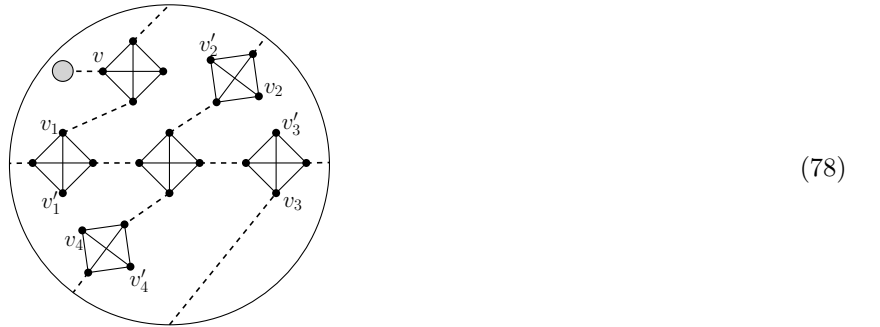

with a 1-point function, and if two bubbles are inserted, they must create a non-trivial 2-point function or a dipole.

Finally, let us try and add a bubble connecting v_1 to v'_4 via a path of colors 0 and 3. The embedding of J_3 in the projective plane enforces a trivial 2-point function between v and v'_2 and between v' and v'_3 , and a 4-point function

in the last region (it may be two 2-point functions)

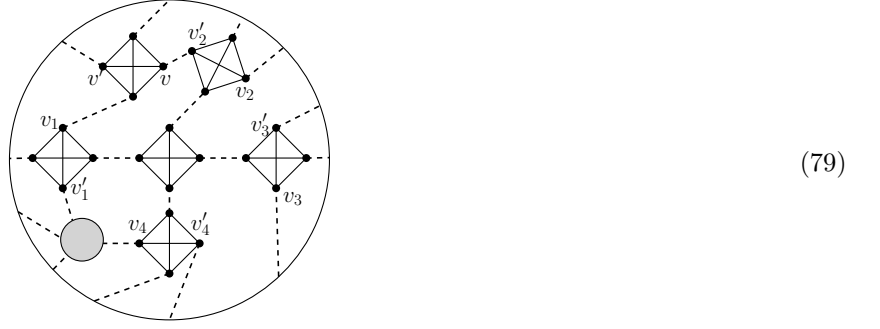

However, there is no way to close the two open faces of color 3 so that they are of length 4. Indeed, this 4-point function has to contain a path of colors 0 and 3 between v'_1 and v_4 with exactly one bubble, which then enforces a 1-point function. If two bubbles connecting v_1 to v'_4 via a path with colors 0 and 3, then it is direct to see that this enforces 3-point functions in the regions R and R' below

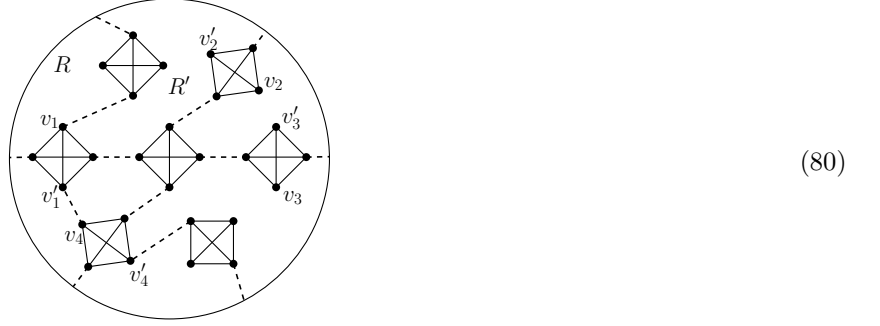

and this is thus impossible.

This leaves no other option than to connect the unpaired vertices of (75) without adding other bubbles and while maintaining the embedding of J_3 in the projective plane. If there is an edge of color 0 between v_1 and v_3 , this creates a dipole. If v_1 is connected to v'_4 instead, then one might connect v_4 to v_2 but this creates a dipole. Instead, v_4 can be connected to v'_3 but then v_3 needs a 1-point function to avoid crossings, which is impossible,

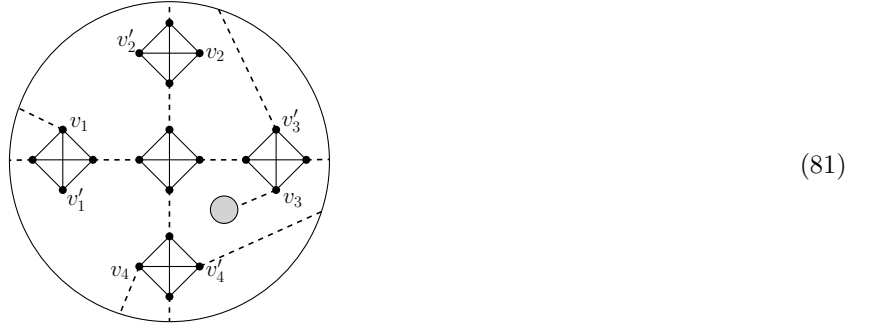

Therefore v_1 can only be connected to v'_2 . Then v_2 cannot be connected to v_4 without forming a dipole, and cannot be connected to v'_1 because the face of color 3 would have length 2 only. Thus, v_2 can only be connected to v'_3 , and

then v_3 to v'_4 and finally v_4 to v'_1

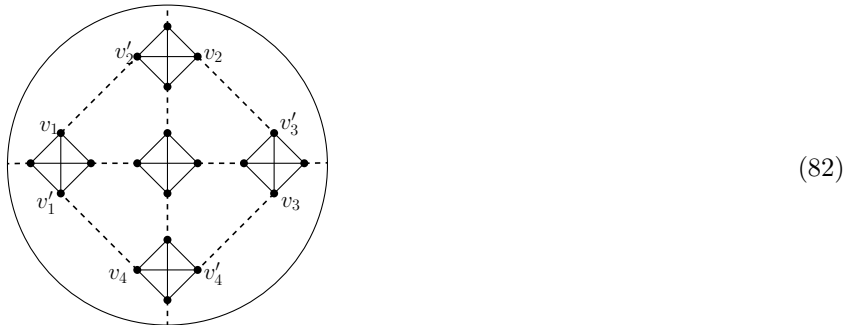

(82)

which is the graph of the Theorem. This concludes the proof. \square

Let us end this section by adding a few comments on the other steps of the strategy to find all graphs of degree $3/2$.

- As for 2PR graphs without melonic insertions (Step 2), it is enough to consider all compositions of G_L and G_R with $\omega(G_L) = 1$ and $\omega(G_R) = 1/2$. Those graphs have been detailed throughout this article. We leave the compositions to the interested reader.
- As for the dipole insertions, as in the case of degree 1, only those which preserve the degree and those which increase the degree by one have to be considered.

IX. CONCLUDING REMARKS

Let us now recall that in [10], the dominant graphs at any order in the large N expansion of the MO model have been studied. We have compared in this paper the diagrammatics of the two SYK-like tensor models, the MO model and the CTKT, or $O(N)^3$ -invariant one. Our main results are:

- an identification of a subset of $O(N)^3$ -invariant graphs which correspond to MO graphs: $O(N)^3$ -invariant graphs with an orientable jacket are MO with the same degree.
- a recipe to identify graphs of a fixed degree ω , outlined in Section V F and applied to the graphs of degree 1 and $3/2$.

A first perspective for future work is to apply our strategy to n -point functions, which are central in SYK-like models (see [12]) and to thus find the relevant graphs at a given order in the $1/N$ expansion.

Given the strong relation we proved between the MO and $O(N)^3$ -invariant models, it is natural to compare our results with the combinatorial analysis of the MO model performed in [10]. There, graphs of arbitrary degree were considered, but only the “most singular” ones which were shown to arise from rooted binary trees (see Proposition 22 of [10]). It then allowed for the implementation of the double scaling mechanism for the MO tensor model, see [15]. In the present paper (independently of the fact that we study here the more general $O(N)^3$ -invariant model), we instead focus on a strategy which identifies all graphs at fixed ω , and not some most singular ones. The cost is that it seems difficult to apply it to an arbitrary order ω , but this is another direction for future work.

Let us also note that that type of analysis of the general term in the large N expansion has already been done in [9] (see also [2] for an LO and NLO analysis) for the colored SYK model (which is a particular case of the SYK generalization introduced in [11]). Therefore, another interesting perspective for future work is the comparison of such an analysis of the general term of $O(N)^3$ -invariant SYK-like tensor model with the results of the analysis of [9] for the colored SYK model.

ACKNOWLEDGMENTS

Valentin Bonzom and Adrian Tanasa are partially supported by the CNRS Infini ”ModTens” grant. Adrian Tanasa is partially supported by the PN 09 37 01 02 grant. Victor Nador is fully supported by the CNRS Infini

”ModTens” grant. Valentin Bonzom is supported by the ANR MetAConc project ANR-15-CE40-0014.

-
- [1] Benedetti, D., Carrozza, S., Gurau, R., Kolanowski, M.: The $1/N$ expansion of the symmetric traceless and the antisymmetric tensor models in rank three (2017)
 - [2] Bonzom, V., Lionni, L., Tanasa, A.: Diagrammatics of a colored SYK model and of an SYK-like tensor model, leading and next-to-leading orders. *J. Math. Phys.* **58**(5), 052301 (2017). doi:10.1063/1.4983562
 - [3] Bonzom, V., Nador, V., Tanasa, A.: Diagrammatic proof of the large N melonic dominance in the SYK model (2018)
 - [4] Carrozza, S.: Large N limit of irreducible tensor models: $O(N)$ rank-3 tensors with mixed permutation symmetry. *JHEP* **06**, 039 (2018). doi:10.1007/JHEP06(2018)039
 - [5] Carrozza, S., Pozsgay, V.: SYK-like tensor quantum mechanics with $Sp(N)$ symmetry (2018)
 - [6] Carrozza, S., Tanasa, A.: $O(n)$ random tensor models. *Letters in Mathematical Physics* (2016). Arxiv:1512.06718
 - [7] Cavicchioli, A., Grasselli, L., Pezzana, M.: Su una decomposizione normale per le n -varietà chiuse. *BOLLETTINO DELL'UNIONE MATEMATICA ITALIANA. B* **17**, 1146–1165 (1980)
 - [8] Dartois, S., Rivasseau, V., Tanasa, A.: The $1/N$ expansion of multi-orientable random tensor models. *Annales Henri Poincaré* **15**, 965–984 (2014). doi:10.1007/s00023-013-0262-8
 - [9] Fusy, E., Lionni, L., Tanasa, A.: Combinatorial study of graphs arising from the Sachdev-Ye-Kitaev model (2018)
 - [10] Fusy, E., Tanasa, A.: Asymptotic expansion of the multi-orientable random tensor model. *The electronic journal of combinatorics* **22**, P1.52 (2015). Arxiv:1408.5725
 - [11] Gross, D.J., Rosenhaus, V.: A Generalization of Sachdev-Ye-Kitaev. *JHEP* **02**, 093 (2017). doi:10.1007/JHEP02(2017)093
 - [12] Gross, D.J., Rosenhaus, V.: All point correlation functions in SYK. *JHEP* **12**, 148 (2017). doi:10.1007/JHEP12(2017)148
 - [13] Gurau, R.: Quenched equals annealed at leading order in the colored SYK model. *EPL* **119**(3), 30003 (2017). doi:10.1209/0295-5075/119/30003
 - [14] Gurau, R.: *Random Tensors*. Oxford Press (2017)
 - [15] Gurau, R., Tanasa, A., Youmans, D.R.: The double scaling limit of the multi-orientable tensor model. *EPL* **111**(2), 21002 (2015). doi:10.1209/0295-5075/111/21002
 - [16] Kitaev, A.: A simple model of quantum holography (2015). URL <http://online.kitp.ucsb.edu/online/entangled15/kitaev/>. KITP Program: Entanglement in Strongly-Correlated Quantum Matter
 - [17] Klebanov, I., Tarnopolsky, G.: Uncolored random tensors, melon diagrams, and the SYK models (2016). Arxiv:1611.08915
 - [18] Klebanov, I.R., Popov, F., Tarnopolsky, G.: TASI Lectures on Large N Tensor Models. *PoS TASI2017*, 004 (2018). doi:10.22323/1.305.0004
 - [19] Klebanov, I.R., Tarnopolsky, G.: On Large N Limit of Symmetric Traceless Tensor Models. *JHEP* **10**, 037 (2017). doi:10.1007/JHEP10(2017)037
 - [20] Maldacena, J., Stanford, D.: Comments on the Sachdev-Ye-Kitaev model. *Physical Review D* **94** (2016). Arxiv:1604.07818
 - [21] Mohar, B., Thomassen, C.: *Graphs on surfaces*, vol. 10. JHU Press (2001)
 - [22] Polchinski, J., Rosenhaus, V.: The Spectrum in the Sachdev-Ye-Kitaev Model. *Journal of High Energy Physics* (2016). Arxiv:1601.06768
 - [23] Ryan, J.P.: Tensor models and embedded Riemann surfaces. *Phys. Rev.* **D85**, 024010 (2012). doi:10.1103/PhysRevD.85.024010
 - [24] Tanasa, A.: Multi-orientable group field theory. *Journal of physics A: Mathematical and Theoretical* (2012). Arxiv:1109.0694
 - [25] Tanasa, A.: The multi-orientable random tensor model, a review. *SIGMA* (2016). Arxiv:1512.02087
 - [26] Witten, E.: An SYK-like model without disorder (2016). Arxiv:1610.09758