

# Familia: A Configurable Topic Modeling Framework for Industrial Text Engineering<sup>\*†</sup>

DI JIANG<sup>‡</sup>, YUANFENG SONG<sup>‡</sup>, RONGZHONG LIAN, SIQI BAO, JINHUA PENG, HUANG HE, and HUA WU, Natural Language Processing Department, Baidu Inc., China

In the last decade, a variety of topic models have been proposed for text engineering. However, except Probabilistic Latent Semantic Analysis (PLSA) and Latent Dirichlet Allocation (LDA), most of existing topic models are seldom applied or considered in industrial scenarios. This phenomenon is caused by the fact that there are very few convenient tools to support these topic models so far. Intimidated by the demanding expertise and labor of designing and implementing parameter inference algorithms, software engineers are prone to simply resort to PLSA/LDA, without considering whether it is proper for their problem at hand or not.

In this paper, we propose a configurable topic modeling framework named Familia, in order to bridge the huge gap between academic research fruits and current industrial practice. Familia supports an important line of topic models that are widely applicable in text engineering scenarios. In order to relieve burdens of software engineers without knowledge of Bayesian networks, Familia is able to conduct automatic parameter inference for a variety of topic models. Simply through changing the data organization of Familia, software engineers are able to easily explore a broad spectrum of existing topic models or even design their own topic models, and find the one that best suits the problem at hand. With its superior extendability, Familia has a novel sampling mechanism that strikes balance between effectiveness and efficiency of parameter inference. Furthermore, Familia is essentially a big topic modeling framework that supports parallel parameter inference and distributed parameter storage. After being open-sourced at Github, Familia rapidly becomes the second most popular project in topic model area, and is widely used in both industrial community and academia. The utilities and necessity of Familia are demonstrated in real-life industrial applications. Familia would significantly enlarge software engineers' arsenal of topic models and pave the way for utilizing highly customized topic models in real-life problems.

CCS Concepts: • **Information systems** → **Data mining**; • **Computing methodologies** → **Topic modeling**;

Additional Key Words and Phrases: Text Semantics, Topic Model, Search Engine

## 1 INTRODUCTION

Topic models have become one kind of important tools for text engineering. In the last decade, a wide spectrum of topic models has been proposed in academia and demonstrates promising performance. However, for industrial topic modeling, Probabilistic Latent Semantic Analysis (PLSA) [11] and Latent Dirichlet Allocation (LDA) [1] are the working horses so far [2][31]. With the richness of the other topic models, to name a few, TOT [35], Bilingual Topic Model [7], Pair Model [14], GeoFolk [32], LATM [34] and Multifaceted Topic Model [33], we rarely witness employment of them in industrial applications. For example, Bilingual Topic Model [7] is more suitable for modeling the query log data in search engine area, however, there are very few convenient tools to support it so far.

<sup>\*</sup>Some components of Familia have been open-sourced at Github (<https://github.com/baidu/Familia>).

<sup>†</sup>This is an extended and revised version of a preliminary paper that was presented in arXiv [15].

<sup>‡</sup>Both authors contributed equally to the paper

Tools	Parameter Estimation Algorithm Number	Topic Model Number	User-defined Model	Unsupervised Data	Supervised Data	Embedding
Peacock	1	1	X	✓	X	X
PLDA+	1	1	X	✓	X	X
LightLDA	1	1	X	✓	X	X
Y!LDA	1	1	X	✓	X	X
Gensim	1	5	X	✓	X	X
<b>Familia</b>	<b>3</b>	<b>N (N&gt;&gt;2)</b>	<b>✓</b>	<b>✓</b>	<b>✓</b>	<b>✓</b>

Fig. 1. Comparison between Familia and other topic modeling tools

The huge gap between the abundance of topic models proposed in academia and their rare appearance in industry is mainly caused by the following reasons:

- (1) Most of existing topic models do not have implementation for convenient usage. Implementing these topic models from scratch is both time-consuming and error-prone;
- (2) Although many tasks cannot be suitably supported by existing topic models, designing a proper topic model and the corresponding parameter inference algorithms are daunting for engineers;
- (3) Most advanced techniques for efficient parameter inference are exclusively designed for PLSA/LDA. Lacking highly efficient parameter inference algorithm impedes most topic models' applicability in industry.

Due to the above reasons, engineers' topic modeling choice is usually limited to PLSA/LDA, which, however, may not fit well their task at hand. Such improper practice heavily undermines the effectiveness of topic models in real-life applications.

In this paper, we propose a novel topic modeling framework, Familia, which is easily configurable and can be utilized as off-the-shelf tool for software engineers without much knowledge of Bayesian networks. Compared with other industrial topic modeling tools (Fig. 1), Familia supports a broad line of topic models, which are of significant presence in the literature as well as heavily demanded in industry. Software engineers can investigate many topic models for their tasks at hand by simply changing the training data organization. Moreover, Familia takes over all the burdens of parameter inference, parallel computing and post-modeling utilities. Specifically, Familia contains three parameter inference methods: Gibbs sampling (GS) and Metropolis Hastings (MH) with alias table [19], based on which a hybrid sampling mechanism is also designed to strike a balance between effectiveness and efficiency. To meet the requirements of topic modeling for massive data, Familia is inherently built upon the Parameter Server (PS) architecture [5][38][20]. Multiple computing nodes can be harnessed for parallel parameter inference and distributed storage. Furthermore, Familia contains multiple built-in post-modeling utilities such as dimensionality reduction and semantic matching, which can be readily applied in many downstream applications.

The contributions of this paper are summarized as follows:

- (1) We identify the huge gap between topic model research in academia and industrial practice of topic modeling. We propose a novel framework, named Familia, which bridges this gap. To the best of our knowledge, it is the first framework that supports multiple topic models in a user-friendly manner. A variety of topic models can be modeled by Familia, to name a few, LDA [1], Supervised LDA [23], Sentence LDA [16], TOT [35], Bilingual Topic Model [7], Pair Model [14], GeoFolk [32], LATM [34] and Multifaceted Topic Model [33]. Besides these

existing models, users can design their own topic models for specific tasks as long as they follow the generative process of Familia.

- (2) We systematically investigate the performance of GS and MH with different topic models. We further propose a hybrid sampling mechanism to balance the effectiveness and efficiency of parameter inference. Based on the earned insights, we provide practical suggestions on choosing sampling method for different topic models.
- (3) We demonstrate the utilities and necessity of Familia in several real-life industrial cases and application that impact millions of users, which also acts like a guide for users to select appropriate topic models for their tasks and apply them in a proper way using Familia. Currently Familia has been widely used in both industrial community and academia, and has become the second most popular project (with more than 1.3k stars and 350 forks) among all the open-sourced topic model tools in Github.

The rest of this paper is organized as follows. In Section 2, we review the related work. In Section 3, we describe the utilities of topic models. In Section 4, we discuss the mathematical foundations of Familia. In Section 5, we detail the parameter inference algorithms. In Section 6, we describe some issues of system implementation. In Section 7, we present the experimental results. Then we discuss several industrial cases in Sections 8. Finally, we conclude this paper in Section 9.

## 2 RELATED WORK

The present work is related to a wide range of topic models in the literature and the recent advances of parameter inference algorithms of LDA.

### 2.1 Topic Models

LDA [1] plays an important role in the field of topic modeling. In the last decade, many extensions of LDA have been proposed to meet specific needs of many applications. For example, [35] presented the Topic-over-Time (TOT) that captures latent topics and their changes over time. Supervised LDA [23] captured the regularity of labelled documents by introducing response signals. Location Aware Topic Model (LATM) [34] is designed to explicitly model the information between locations and words. GeoFolk [32] focuses on discovering latent topics from social media by using text features as well as spatial information. [16] proposed Sentence LDA that assumes all words from one sentence are generated from one topic. A bilingual topic model was proposed in [7] as a language modeling framework, in which the topics are learned from query-title pairs. Multi-Faceted Topic Model (MfTM) [33] was proposed to capture the temporal characteristics of each topic by jointly modeling latent semantics among terms and entities. Although the aforementioned ones take only a small portion of topic models in the literature, they are suitable choices in many industrial scenarios. However, to the best of our knowledge, none of them are supported by existing industrial topic model systems such as PLDA+ [22], Peacock [36] and Gensim [28]. However, compared to Familia, these existing systems only support limited kinds of topic models, and to the best of our knowledge, none of above topic models except LDA are supported by existing systems.

### 2.2 Advanced Parameter Inference of LDA

The latest advances of parameter inference of LDA roughly fall into two major categories: (1) Parallel parameter inference; (2) Efficient sampling algorithms. We review the related works from the two categories respectively.

*2.2.1 Parallel Parameter Inference.* Parallelization is a straightforward approach for speeding up parameter inference. [24] proposed distributed algorithm for LDA. Their algorithm partitioned the data across separate processors and conduct inference in a parallel approach. Each processor

performs Gibbs sampling over local data and then a global synchronization merges updates from all processors. It was shown that the converged probability for distributed learning is similar to that obtained with single-processor. Thereafter, [36] proposed a distributed topic modeling system named Peacock, which is a hierarchical distributed architecture for training LDA. More recently, [40] proposed a model-parallel scheme that leverages dependency to efficiently train LDA and the scheme is frugal on memory consumption and network communication.

**2.2.2 Efficient Sampling Algorithms.** Another major research trend of LDA parameter inference is to design efficient sampling algorithms. Conventional Gibbs sampling [8] has a complexity of  $K$  per sample when the topic amount is set to  $K$ . [26] introduced FastLDA, which has a complexity of significantly less than  $K$  per sample. [39] proposed SparseLDA that contains both an algorithm and data structures for efficiently conducting Gibbs sampling. [19] proposed an algorithm which achieves  $O(K_d)$  sampling complexity, where  $K_d$  is the instantiated topics in the document. As one step further, [40] proposed LightLDA, which uses an Metropolis-Hastings sampling algorithm and achieves  $O(1)$  time complexity per token. Recently, [3] proposed WarpLDA, which achieves both  $O(1)$  time complexity per token and  $O(K)$  scope of random access. With their effectiveness, these techniques are exclusively designed for LDA. Their applicability has never been explored in a broader scope of topic models, on which how to conduct efficient sampling is still an open question.

**2.2.3 Variational Bayesian Inference.** Variational inference has also been widely used for approximating intractable integrals arising in Bayesian inference. The concept is initially from statistical physics, and [25] adopts it to probabilistic inference, which fits a neural network using Mean-field variational inference methods. Meanwhile, [9] also combines variational algorithms with neural network models. In early 1990s, variational inference methods are generalized to many probabilistic models [29] [13] and [17]. LDA [1] relies on Mean-field variational inference method before various sampling algorithms becoming popular. Recent works in this area focus on making variational inference methods more scalable, easy to derive and supporting more complex models [18] [27]. For example, stochastic variational inference [10] scales variational inference to massive data.

### 3 INDUSTRIAL UTILITIES

Based on a comprehensive survey of industrial applications, we find that the industrial utilities of topic models essentially fall into two major categories: (1) dimensionality reduction; (2) semantic matching. In this section, we describe the details of these two utilities, which motivate the design philosophy of Familia.

#### 3.1 Dimensionality Reduction

Topic models are powerful tools for representing high dimensional data in a lower dimension [39]. Through applying topic models, each “document” can be represented with its topic distribution. This can be considered as dimensionality reduction, since the topic space is typically much smaller than the original data space. The topical representation of each document can be conveniently utilized as features in downstream tasks such as document clustering and document classification [1].

#### 3.2 Semantic Matching

Another utility of topic models is semantic matching, i.e., calculating a score to indicate the relevance between a “query”  $q$  and a “document”  $d$  [37][31]. There exist two paradigms of deriving the score. The first one is based upon Jensen-Shannon divergence [21]:

$$Score(q, d) = 1 - \text{JSD}(t_q \parallel t_d) = 1 - \frac{1}{2}D(t_q \parallel M) - \frac{1}{2}D(t_d \parallel M), \quad (1)$$

where  $t_q$  is the topic distribution of  $q$ ,  $t_d$  is the topic distribution of  $d$ ,  $M = \frac{1}{2}(t_q + t_d)$  and  $D(\cdot)$  stands for Kullback-Leibler divergence. A more convenient approach is based on calculating the overall probability of each item in  $q$  generated by  $d$ :

$$Score(q, d) = \prod_{w \in q} P(w|d) = \prod_{w \in q} \sum_z P(w|z)P(z|d), \quad (2)$$

where  $w$  is the item in  $q$ ,  $P(z|d)$  is the probability of  $d$  generating  $z$  and  $P(w|z)$  is the probability of  $z$  generating  $w$ .

#### 4 GENERATIVE ASSUMPTION

In this section, we discuss the mathematical foundations of Familia. Since Familia aims to define the generative process of a series of topic models, we abstract the data organization and structure shared by all these models. We describe Familia in conventional topic model terminologies, and three newly introduced terminologies are formally defined as follows:

- (1) *blob*: the basic unit in which all the items are generated by the same topic, such as a sentence for SentenceLDA.
- (2) *factor*: the basic unit in which all the item are generated by the same distribution and the same topic; for example, all the words in one sentence usually comprise one factor for TOT. In terms of the distribution being continuous or discrete, the factors can be further categorized as continuous factor and discrete factor. For example, all the timestamps in one sentence usually belong to the same continuous factor for TOT.
- (3) *item*: the basic unit of an observed variable, such as a word, a timestamp, etc

The generative process is depicted in Algorithm 1. In order to generate a document  $d$ , we first draw  $\theta_d$ , which is a Multinomial distribution over topics. Then, for each blob, we draw a topic  $z$ . Based upon  $z$ , for each discrete factor  $i$ , we generate discrete items  $u$  according to the corresponding discrete distribution  $\phi_{iz}$ . The continuous items are generated in an analogous approach. Finally, if the topic model needs to capture the supervised signal (e.g., the category of the document or the rating of the quality of the document), the signal is further drawn from a Gaussian distribution that uses  $\bar{z}_d$  as parameters. Specifically,  $\bar{z}_d = \frac{1}{N} \sum_{n=1}^N z_n$ , where  $N$  is the amount of tokens in the document.

It is easy to see that Algorithm 1 is a generic process for many topic models. A variety of topic models can be modeled by Algorithm 1, to name a few, LDA[1], Supervised LDA[23], Sentence LDA[16], TOT[35], Bilingual Topic Model[7], Pair Model[14], GeoFolk [32], LATM[34] and Multifaceted Topic Model[33]. Besides these existing models, users can design their own topic models for specific tasks as long as they follow the generative process in Algorithm 1. It is not difficult to see that the topic models supported by Familia can be conveniently applied to scenarios where the two utilities discussed in Section 3 are used.

#### 5 PARAMETER INFERENCE

We proceed to discuss how to conduct parameter inference for Familia. We detail the mathematical derivation for the most complicated scenario where there simultaneously exist discrete factors, continuous factors and the supervised response. The other simpler scenarios can be trivially derived based upon the following discussion. The generative process of Algorithm 1 can be translated into joint distribution, and the objective is to maximize the likelihood of the observed items and

---

**ALGORITHM 1:** Generative Process of Familia
 

---

```

for each topic  $k \in 1, \dots, K$  do
  for each discrete factor  $i \in 1, \dots, M$  do
    | draw a discrete factor distribution  $\phi_{ik} \sim \text{Dirichlet}(\beta_i)$ 
  end
  for each continuous factor  $j \in 1, \dots, N$  do
    | generate a continuous factor distribution  $\psi_{jk}$ 
  end
end
for each document  $d \in 1, \dots, D$  do
  generate topic distribution  $\theta_d \sim \text{Dirichlet}(\alpha)$ 
  for each blob  $b$  in  $d$  do
    generate a topic  $z \sim \theta_d$ 
    for each discrete factor  $i \in 1, \dots, M$  do
      | generate items  $u \sim \phi_{iz}$ 
    end
    if there exists continuous factor then
      for each continuous factor  $j \in 1, \dots, N$  do
        | generate items  $v \sim \psi_{jz}$ 
      end
    end
  end
  if there exists supervised signal then
    | draw signal  $y_d \sim P(y_d | \bar{z}_d, \eta, \sigma^2)$ , where  $P(y_d | \bar{z}_d, \eta, \sigma^2) = N(y_d | \eta^T \bar{z}_d, \sigma^2)$ 
  end
end

```

---

the supervised signals. The complete likelihood  $P(\mathbf{u}_{1\dots M}, \mathbf{v}_{1\dots N}, \mathbf{y}_{1\dots D}, \mathbf{z} | \alpha, \beta, \Psi, \eta, \sigma)$  is presented as follows:

$$\begin{aligned}
 P(\mathbf{z} | \alpha) & \underbrace{\prod_{i=1}^M P(\mathbf{u}_i | \mathbf{z}, \beta)}_{\text{discrete factors}} \underbrace{\prod_{j=1}^N P(\mathbf{v}_j | \mathbf{z}, \Psi)}_{\text{continuous factors}} \underbrace{\prod_{d=1}^D P(y_d | \bar{z}_d, \eta, \sigma^2)}_{\text{supervised signal}} \\
 & = \left( \frac{\Gamma(\sum_{z=1}^T \alpha_z)}{\prod_{z=1}^T \Gamma(\alpha_z)} \right)^D \prod_{d=1}^D \frac{\prod_{z=1}^T \Gamma(m_{dz} + \alpha_z)}{\Gamma(\sum_{z=1}^T (m_{dz} + \alpha_z))} \\
 & \prod_{i=1}^M \left( \frac{\Gamma(\sum_{u_i=1}^{U_i} \beta_{u_i})}{\prod_{u_i=1}^{U_i} \Gamma(\beta_{u_i})} \right)^T \prod_{z=1}^T \frac{\prod_{u_i=1}^{U_i} \Gamma(n_{zu_i} + \beta_{u_i})}{\Gamma(\sum_{u=1}^{U_i} (n_{zu_i} + \beta_{u_i}))} \\
 & \prod_{j=1}^N \prod_{d=1}^D \prod_{l=1}^{L_d} P(v_{jdl} | \psi_{zdl}) \prod_{d=1}^D P(y_d | \bar{z}_d, \eta, \sigma^2)
 \end{aligned} \tag{3}$$

where  $m_{dz}$  denotes the number of sentences that are generated by topic  $z$  in document  $d$ .  $n_{zv}$  is the number of times that  $v$  is generated by topic  $z$  through Multinomial distribution and  $\Gamma(\cdot)$  indicates Gamma function. The goal of parameter inference is to estimate  $\Theta, \Phi, \Psi, \eta$  and  $\sigma$  in Algorithm 1 through sampling the latent topic  $z$  of each blob. In this following two subsections, we describe how to sample  $z$  through Gibbs sampling and Metropolis Hastings based on Eq. (3). Utilizing the

sampled  $z$  to estimate the parameters of discrete distributions is well-documented in literature [16]. We will detail how to utilize  $z$  to estimate the parameters of continuous distribution in Section 5.3.

## 5.1 Gibbs Sampling

According to Bayes rule and Eq. (3), the full conditional of blob  $b$  belonging to topic  $k$  in document  $d$  is as follows:

$$P(z_b = k | \mathbf{u}_{1\dots M}, \mathbf{v}_{1\dots N}, \mathbf{y}_{1\dots D}, \mathbf{z}_{-b}, \alpha, \beta, \Psi, \eta, \sigma) = \frac{m_{dk} + \alpha_k}{\sum_{k'=1}^K (m_{dk'} + \alpha_{k'})} \prod_{i=1}^M \frac{\Gamma(\sum_{u=1}^{U_i} (n_{ku} + \beta_u))}{\Gamma(\sum_{u=1}^{U_i} (n_{ku} + \beta_u + N_{bu}))} \prod_{u_i \in b} \frac{\Gamma(n_{ku_i} + \beta_{u_i} + N_{bu_i})}{\Gamma(n_{ku_i} + \beta_{u_i})} \prod_{j=1}^N \prod_{l=1}^{L_b} P(v_{jl} | z_k) \times P(y_d | \bar{z}_d, \eta, \sigma^2) \quad (4)$$

In order to sample a new topic for the blob  $b$ , we need to calculate the above conditional probability for all topics and conduct normalization. Hence, the time complexity for sampling a topic for a blob is  $O(K)$ , where  $K$  is the topic amount.

## 5.2 Metropolis Hastings

If the topic amount  $K$  is large, the  $O(K)$  per blob complexity is time-consuming. We now propose an efficient alternative based upon Metropolis Hastings (MH), which has been successfully applied in [19] [40] for LDA. For the convenience of designing proper proposals for MH, we first conduct approximation to Eq. (4) as follows:

$$Q(z_b = k | \mathbf{u}_{1\dots M}, \mathbf{v}_{1\dots N}, \mathbf{y}_{1\dots D}, \mathbf{z}_{-b}, \alpha, \beta, \Psi, \eta, \sigma) \approx \underbrace{\frac{m_{dk} + \alpha_k}{\sum_{k'=1}^K (m_{dk'} + \alpha_{k'})}}_{\text{document-topic proposal}} \underbrace{\prod_{i=1}^M \prod_{u_i \in b} \frac{n_{ku_i} + \beta_{u_i}}{\sum_{u=1}^{U_i} (n_{ku} + \beta_u)}}_{\text{discrete item-topic proposal}} \underbrace{\prod_{j=1}^N \prod_{l=1}^{L_b} P(v_{jl} | z_k)}_{\text{continuous item-topic proposal}} \times \underbrace{P(y_d | \bar{z}_d, \eta, \sigma^2)}_{\text{supervised signal proposal}} \quad (5)$$

The above equation approximates Eq. (4) when an item appears multiple times within a blob. Based on this approximation, we discuss the MH sampling method for Familia. MH needs proper proposals to work. We now discuss four proposals which fall into two major categories: document-based proposal and item-based proposal.

- Document-based Proposals:

The first document-specific proposal is the *document-topic proposal*:

$$Q_d(k) \propto \frac{m_{dk} + \alpha_k}{\sum_{k'=1}^K (m_{dk'} + \alpha_{k'})} \quad (6)$$

According to the MH algorithm, the acceptance ratio from state  $i$  to  $j$  is:

$$\min \left\{ 1, \frac{Q(j)Q_d(i)}{Q(i)Q_d(j)} \right\} \quad (7)$$

The second document-specific proposal is the *supervised signal proposal*:

$$Q_{y_d}(k) \propto P(y_d | \bar{z}_d, \eta, \sigma^2) \quad (8)$$

According to the MH algorithm, the acceptance ratio from state  $i$  to  $j$  is:

$$\min \left\{ 1, \frac{Q(j)Q_{y_d}(i)}{Q(i)Q_{y_d}(j)} \right\} \quad (9)$$

• Item-based Proposals:

The first item-based proposal is the *discrete item-topic proposal*, which is denoted as  $Q_u(k)$ :

$$Q_u(k) \propto \frac{n_{ku_i} + \beta_{u_i}}{\sum_{u=1}^{U_i} (n_{ku} + \beta_u)} \quad (10)$$

According to the MH algorithm, the acceptance ratio from state  $i$  to  $j$  is:

$$\min \left\{ 1, \frac{Q(j)Q_u(i)}{Q(i)Q_u(j)} \right\} \quad (11)$$

The second item-based proposal is the *continuous Item-topic proposal*, which is denoted as  $Q_v(k)$ :

$$Q_v(k) \propto P(v_{jl} | z_k) \quad (12)$$

According to the MH algorithm, the acceptance ratio from state  $i$  to  $j$  is:

$$\min \left\{ 1, \frac{Q(j)Q_v(i)}{Q(i)Q_v(j)} \right\} \quad (13)$$

It is easy to see that each proposal encourages the sparsity of their corresponding component in Eq. (5). For fast sampling from each proposal, a data structure named alias table [19][40] is utilized to reduce the sampling complexity (see Fig. 2). Theoretically, an alias table need to be created for each document and each item. A caveat is that document-topic proposal does not need to explicitly establish alias table [40], because sampling from the document-topic proposal can be cheaply simulated through returning the topic assignment of a randomly sampled blob in the document. The MH method is formally presented in Algorithm 2. When sampling a new topic for a blob, the algorithm sequentially utilizes document-based proposals and item-based proposals to update the topic candidates. For each topic candidate, the algorithm chooses whether to accept it according to the acceptance ratio, just like the standard Metropolis Hastings. Note that this process can be repeated for several iterations and each iteration is formally defined as an *MH step*. In the experiment section, we will show the extent to which the number of MH steps can affect the performance of the MH method.

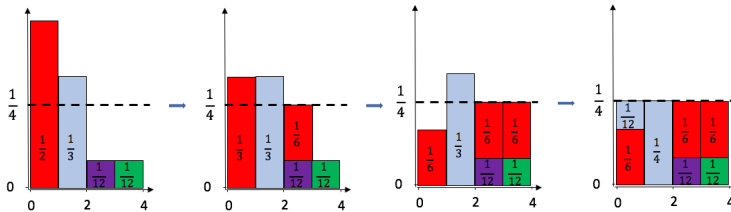

Fig. 2. An example of Alias Table construction, which transform a non-uniform sampling process into a uniform sampling one. The whole process enables  $O(1)$  amortized sampling complexity.



---

**ALGORITHM 2:** Metropolis Hastings of Familia

---

```
for each document  $d \in 1, \dots, D$  do
  for each blob  $b$  in  $d$  do
    for a predefined number of MH steps do
      propose a topic  $z_1$  based on document-topic proposal according to Eq. (6)
      update the topic to  $z'_1$  according to acceptance ratio according to Eq. (7)
      propose a topic  $z_2$  based on alias table of  $y_d$  according to Eq. (8)
      update the topic to  $z'_2$  according to acceptance ratio according to Eq. (9)
      for each discrete factor  $i \in 1, \dots, M$  do
        for item  $u$  in this factor do
          propose a topic  $z_{u3}$  based on alias table of  $u$  according to Eq. (10)
          update the topic to  $z'_{u3}$  according to acceptance ratio according to Eq. (11)
        end
      end
      for each continuous factor  $j \in 1, \dots, N$  do
        for item  $v$  in this factor do
          propose a topic  $z_{v4}$  based on alias table of  $v$  according to Eq. (12)
          update the topic to  $z'_{v4}$  according to acceptance ratio according to Eq. (13)
        end
      end
    end
  end
end
```

---

### 5.3 Issues of Continuous Distributions

For topic models with continuous factors, updating the parameters of continuous distributions is computationally expensive, especially for distributed environment in which the synchronization of these parameters is needed. In Familia, we choose a well-adopted practice [35][32]: we update the parameters of the continuous distributions after each major iteration (i.e., scanning through the whole corpus of training data). For Gaussian distributions, we straightforwardly update the parameters by the sample mean and sample variance. If the continuous distribution is Beta distribution  $Beta(\psi_{k1}, \psi_{k2})$ , we update the parameters  $\psi_{k1}$  and  $\psi_{k2}$  for the  $k$ th topic as follows:

$$\psi_{k1} = \bar{s}_k \left( \frac{\bar{s}_k(1 - \bar{s}_k)}{v_k^2} - 1 \right), \quad (14)$$

$$\psi_{k2} = (1 - \bar{s}_k) \left( \frac{\bar{s}_k(1 - \bar{s}_k)}{v_k^2} - 1 \right), \quad (15)$$

where  $\bar{s}_k$  and  $v_k^2$  denote the sample mean and biased sample variance of topic  $k$ 's items. As for supervised signals [23], we denote the  $(D \times K)$  matrix whose  $d$ th row is  $\bar{z}_d^T$  as  $A$ , and the  $D \times 1$  vector of supervised signals as  $Y$ , the  $\eta$  and  $\sigma$  are updated as follows:

$$\eta = (A^T A)^{-1} A^T Y \quad (16)$$

$$\sigma = \frac{1}{D} (Y^T Y - Y^T A (A^T A)^{-1} A^T Y) \quad (17)$$

In practice, the above matrix manipulation can be approximated by techniques to reduce the computational cost and scale to large data set.

## 5.4 Hybrid Sampling Mechanism

So far, we have discussed two basic sampling techniques that are supported in Familia. The major advantage of MH is efficiency: the per blob sampling complexity can be reduced as low as  $O(1)$  for some topic models through utilizing alias tables. However, as we will show later in Section 7, the models trained by GS are usually better than MH. Hence, it is desirable to design a mechanism that tradeoffs the efficiency of MH and effectiveness of GS. To meet this requirement, Familia enables the users to choose the sampling method for each iteration. Such flexibility makes it possible to investigate many hybrid sampling mechanisms which collectively apply GS and MH.

## 6 SYSTEM IMPLEMENTATION

In this section, we describe some important issues about system implementation of Familia. In Section 6.1, we describe the data organization of Familia. In Section 6.2, we discuss the data and parameter storage.

### 6.1 Data Organization

In Familia, data organization is critical for automating parameter inference because it provides basic information of Bayesian network structure of the topic model. Based on data organization, Familia can deduce each component in Eq. (4) and Eq. (5) and then conduct parameter inferences without imposing any burden on human to derive the mathematical equations. Documents are grouped as blocks to facilitate distributed computing. In each document, the blob is utilized as the basic unit whose content shares the same topic. A blob contains multiple factors and a factor can contain any amount of items. The data organization of Familia is presented as follows:

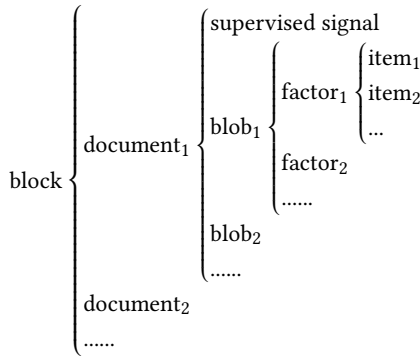

The above data organization is generic. In practice, the “item” in Familia data organization can be specialized into words(discrete), tags(discrete) or even timestamps(continuous).

Now we demonstrate how to specialize the above data organization for several common topic models in Figure 3. For example, the data organization of LDA is described in Figure 3a.

LDA only contains one kind of items: the words. It assumes that words are exchangeable in document. Hence, each blob only contains one factor and each factor contains one single word. The data organization of TOT is described in Figure 3d.

Each blob in TOT data organization contains two kinds of factors. Relying on such data organization, it is easy to see that GS and MH discussed in Section 5 can be automatically conducted for topic models which are described by Algorithm 1.

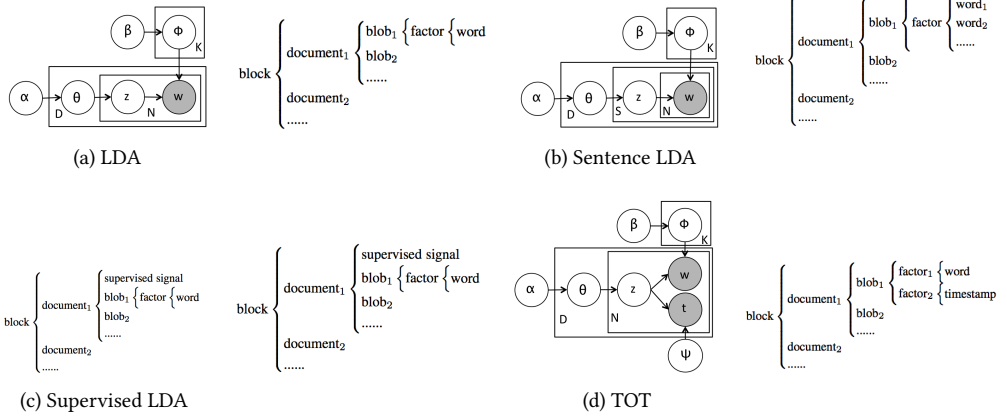

Fig. 3. Common Topic Models Examples and their Corresponding Data Organization in Familia

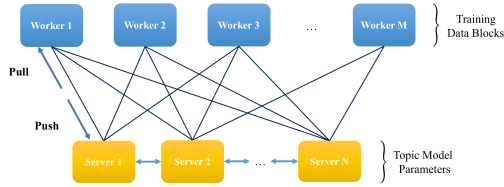

Fig. 4. Parameter Server Architecture

## 6.2 Data and Parameter Storage

Familia adopts classic Parameter Server (PS) [38][20] architecture (see Figure 4) for distributed computing. Both training data and topic model parameters are distributed on multiple computing nodes. The training data (i.e., the training data blocks) are sharded by their identifiers on workers while topic model parameters of discrete distributions are sharded by item identifiers on servers. Each worker only pulls the parameters that are needed for processing the current block to the local memory. After the sampling procedure, each worker pushes the update information back to servers. Detailed description of PS is beyond the scope of this paper, interested readers may refer to [38][20] for more information.

## 7 EXPERIMENTS

In this section, we report the experimental results. We first investigate the performance of a series of sampling methods across topic models and data sets in Section 7.1. Then we demonstrate the scalability of Familia on multiple computing nodes in Section 7.2.

### 7.1 Performance of Sampling Methods

We systematically investigate the performance of different sampling methods in terms of LDA, Sentence LDA and TOT. In order to minimize effect beyond algorithmic performance, experiments in this subsection are conducted on a single computing node. NIPS dataset from UCI Bag of Words

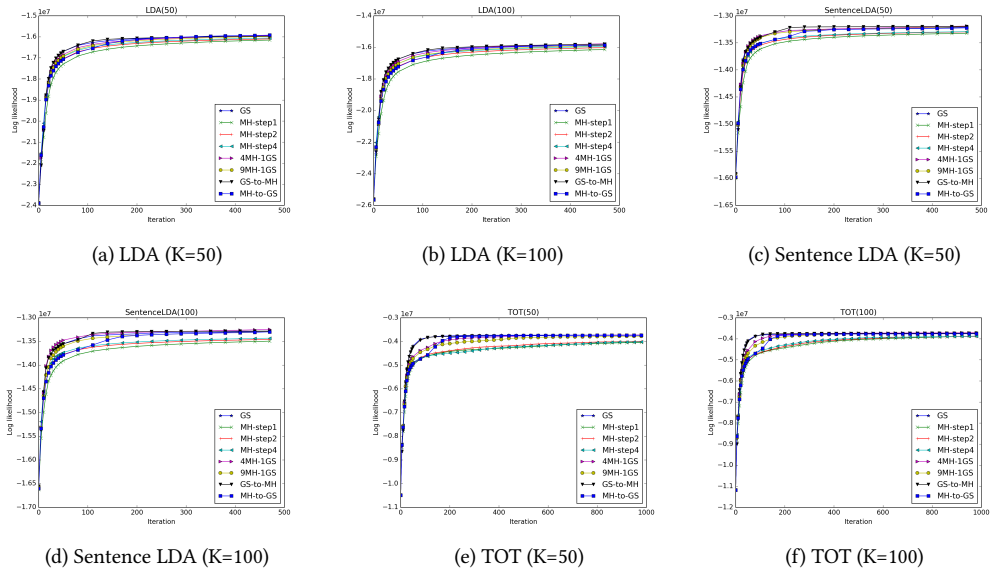

Fig. 5. Comparison of Sampling Methods (Iteration) (Best Viewed in Color)

Data Set<sup>1</sup> is utilized for experiments of LDA. Amazon data<sup>2</sup> is utilized for Sentence LDA. As for TOT, we utilize the 21 decades of U.S. Presidential State-of-the-Union Addresses<sup>3</sup> for the experiments. Due to space limitation, we present the results when the topic amount is set to 50 and 100. Similar insights can be obtained when the topic amount is set to other values.

The log likelihood of each sampling methods is plotted against iteration in Figure 5 and against time in Figure 6. Therein, MH-step1 is MH with only one MH step. Analogously, MH-step2 and MH-step4 are MH with 2 and 4 MH steps respectively. 4MH-1GS is the sampling method that performs one iteration of GS after every 4 iterations of MH. 9MH-1GS performs one iteration of GS after every 9 iterations of MH. GS-to-MH starts with GS for the first 100 iterations and then switches to MH for the remaining iterations. MH-to-GS starts with MH for the first 100 iterations and then switches to MH for the remaining iterations. Note that space limitation prevents us from presenting more parameter settings for each sampling method. However, the results shown in Figures 5 and 6 are sufficient to showcase our insights obtained from this study.

We first investigate the performance of MH in terms of the number of steps. From Figure 5, we observe that larger MH steps usually result in better performance. In most cases, 4-step is better than 2-step and further better than 1-step. The experimental results of all the three topic models verify the above argument. We proceed to compare the performance of different sampling methods. A possible explanation is that more MH steps help the sampling method to explore more states if the Markov chain has low conductance.

For these three topic models, 4MH-1GS usually achieves the best performance while MH (including all the three MH methods with different steps) usually demonstrates the worst performance. The performance of GS and the other hybrid methods is between 4MH-1GS and MH. 4MH-1GS

<sup>1</sup><https://archive.ics.uci.edu/ml/datasets/Bag+of+Words>

<sup>2</sup><http://uilab.kaist.ac.kr/research/WSDM11>

<sup>3</sup><http://www.gutenberg.org/dirs/etext04/suall11.txt>

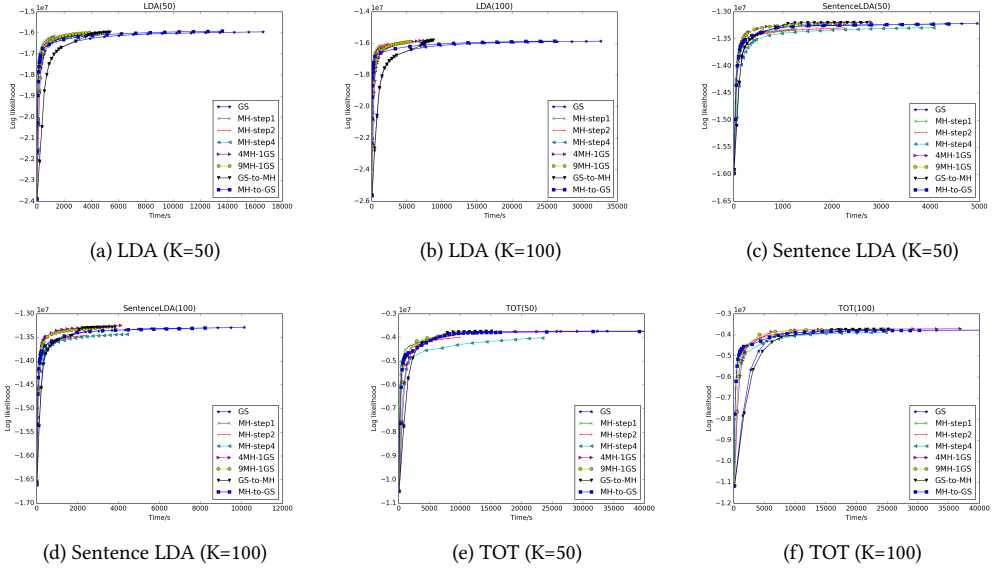

Fig. 6. Comparison of Sampling Methods (Time) (Best Viewed in Color)

is better than 9MH-1GS, showing that fairly high frequency of switching MH and GS is effective to improve the model quality. The hybrid methods have higher chance to prevent the sampling algorithm getting “stuck” in a subset of Markov chain states. Hence, MH is not a good choice if the quality of the resultant model is highly valued.

From Figure 6, we observe that MH-step1 achieves a fairly good model within the least time while GS takes the longest time. The time consumed by hybrid sampling methods is between MH-step1 and GS. The superiority of MH in efficiency is achieved by reusing the alias tables, which can reduce the amortized time complexity to as low as  $O(1)$  per blob. In contrast, the complexity of GS is  $O(K)$  per blob, since it needs to calculate the probability for each topic.

Based upon above observations, we obtain the following important insights, which are valid across the three different topic models: 1. GS achieves higher likelihood than MH while MH consumes less time to achieve a fairly good result; 2. Some hybrid sampling methods can achieve even better result than GS while consumes less time than GS. 3. If the quality of the model is the emphasis, hybrid sampling methods like 4MH-1GS should be chosen because it achieves the best model quality with fairly good efficiency. If efficiency is the focus, MH may be chosen since it consumes the least time to generate a reasonably good model.

## 7.2 Scalability of Familia

We proceed to demonstrate the scalability of Familia with 1, 5, 10 and 20 computing nodes. The log likelihood of the three topic models trained on 10 nodes is presented in Figure 7, from which we observe that the results obtained from 10 nodes is aligned with those from a single node, showing that the quality of these three models trained by different sampling methods is not heavily affected by the distributed environment. Although all sampling methods achieve slightly lower log likelihood than those of single node, such degradation is modest in practice. In distributed environment, 4MH-1GS is the method with the best performance and MH methods usually achieve

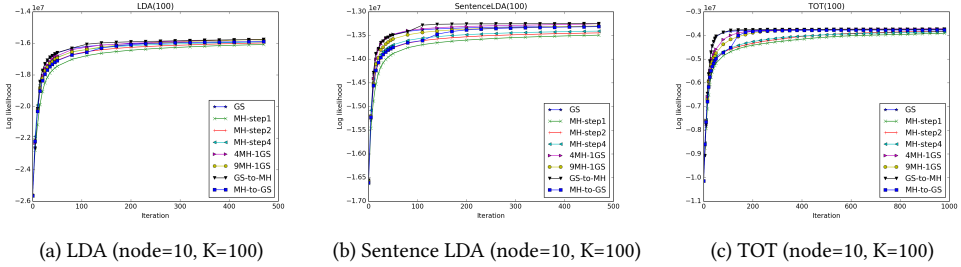

Fig. 7. Comparison of Sampling Methods (Parallel-Iteration) (Best Viewed in Color)

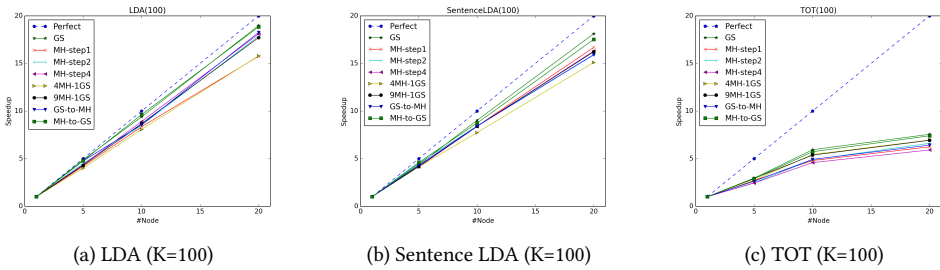

Fig. 8. Speedup Analysis (Best Viewed in Color)

the lowest likelihood. The insights discussed in Section 7.1 still hold for training topic models in distributed environment. Similar phenomenon is observed when the number of nodes is set to 5 or 20 and their results are skipped due to space limitation.

Another important question is how much speedup we obtain when multiple computing nodes are involved. The speedup analysis of the three topic models is presented in Figure 8. High speedup ratio is an indicator of low communication and synchronization cost. With training topic models with PS, low communication cost is primarily achieved by the sparsity of the model under training. The sparser the model is, the less the parameters that each worker needs to pull from servers. When sorted by speedup ratio, the ranking of these sampling methods varies from model to model, showing a specific sampling method has different capability of promoting the sparsity of a topic model. However, for all the three topic models, GS always has the best speedup ratio, indicating that GS is quite effective in promoting the sparsity of the model. Compared with LDA and Sentence LDA, all sampling methods of TOT have lower speedup ratios due to the synchronization of continuous parameters at each iteration. Hence, topic models without continuous factors can take full advantage of the asynchronous parallelization of PS. Topic models with continuous factors usually have lower speedup ratio due to the synchronous parallelization caused by continuous parameters.

## 8 INDUSTRIAL CASES AND APPLICATION

Currently, Familia has been widely used in both industrial community and academia. In this section, we first propose a guide for users to select appropriate topic models for their tasks and apply them in a proper way using Familia in Subsection 8.1 and 8.2. The success of the cases cannot be achieved if LDA is the only topic model in software engineers' arsenal. Then a real-life industrial application

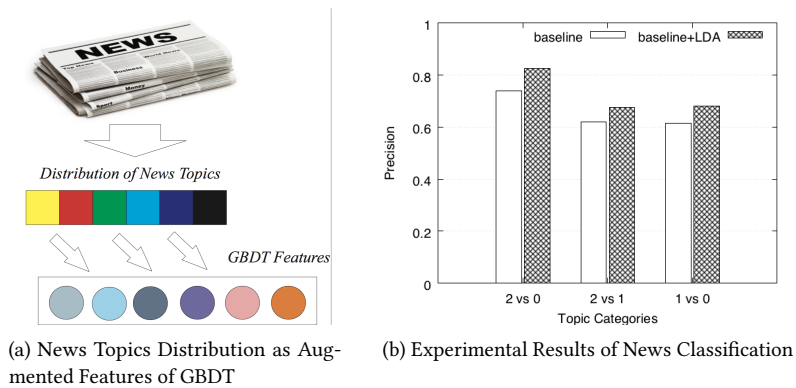

Fig. 9. Classification of News Articles

is presented to further showcase the benefit acquired from the aforementioned paradigms and models using Familia in Subsection 8.3.

## 8.1 Semantic Representation

We first discuss some cases involving semantic representation. The semantic representation derived by topic modeling typically works as features for other machine learning models.

**8.1.1 Document Classification.** The first case is **classification of news articles**. For news feed service, the articles collected from various sources often contain low-quality ones. In order to improve user experience, we need to design a classifier to distinguish the good ones from the bad ones. Conventionally, the classifier is built upon some handcrafted features, which include source sites, text length, the total number of images, etc. We could employ topic model to obtain the topical distribution of each article and augment the handcrafted features with this distribution (shown in Figure 9a). As an experiment, we prepare 7,000 news articles, which are manually labeled into 5 categories, in which 0 stands for those of the lowest quality, and 4 represents for the best. We train Gradient Boosting Decision Tree (GBDT) on 5,000 articles with different features and test the trained classifier on the other 2,000 articles. Figure 9b shows the result from the two classifiers using different sets of features: baseline, baseline+LDA. The results of using features of topic model are significantly better, showing that topic model is an effective way for document representation.

**8.1.2 Document Clustering.** Straightforwardly, the semantic representation of documents could be utilized for clustering. In the task of **clustering new articles**, we use LDA to compute the topic distribution of news articles and cluster the articles by K-means. Figure 10 shows two clusters which are obtained by clustering 1000 articles into ten groups. Cluster1 is of articles related to interior design and Cluster2 contains articles about the stock market. The result shows that news articles can be semantically clustered based on their topic distributions.

**8.1.3 Dimensionality Reduction in News Quality Evaluation.** Quality evaluation is critical for news recommendation. We now show how topic distributions of each news articles are utilized for news quality evaluation. The topic distribution of each news article is added as extra features for Gradient Boosting Decision Tree [6]. We utilize one-day news articles collected by a commercial spider for training and 2000 news articles for testing. Each article is labeled by human experts with a quality indicator ranging from 0 to 2, where 0 indicates a poor quality while 2 shows that

Cluster1	Cluster2
老公嫌小户型客厅太小，连电视都不要，装修完结果让人无言以对 (My husband thinks the living room of small apartment is too small so that he don't even set a TV there. However, the housing decoration is remarkable!)	中药化药上市公司业绩领跑医药板块 (Listed companies' performance of traditional Chinese medicine and chemical medicine lead in the pharmaceutical sector.)
新房装修阳台这样设计，客人来了抢着睡阳台，早知道多装几个！(When the balcony of the new apartment is decorated in this way, it makes the balcony very popular with guests. If known it earlier, this design would be applied more extensively!)	[买入评级]通灵珠宝(603900)简评，“王后”单品快速成长苏外区亦扩张迅速 [Stock "Buy" Rating] Brief comments of Leysen Jewellery Inc.(603900): The "Queen" becomes the best-selling product, and rapidly expands outside Jiangsu Province.
装修房子99%的人想不到这一点，但却大用处! (Usually it's ignored by 99% people who is spruced up their houses. But it is extremely useful.)	中钢国际：全年业绩稳增 买入评级 (Sinosteel Corporation: Annual profit steady increases , and got "Buy" rating)
南阳170平都没想过这效果，找对人装修太关键了 (Even a 170m <sup>2</sup> apartment in Nanyang City can't have this effect, and it is so important to find the right person to do the decoration job.)	雪浪环境：国家队布局 业绩预增 (Xuelang Environment Ltd.: National arrangement policies indicate a positive profit alert)

Fig. 10. Example of Clustering News Articles

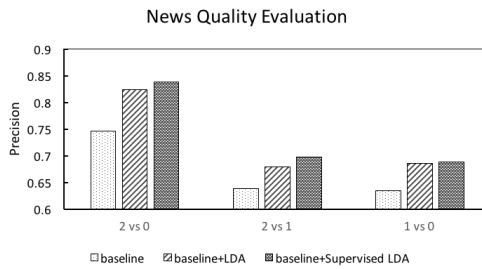

Fig. 11. News Quality Evaluation

the article is of high quality. We compare different feature settings (i.e., baseline, baseline+LDA and baseline+Supervised LDA) in terms of the precision of separating news from different quality category. The baseline is composed of statistical features such as article length, image amount, entity amount, etc. Two insights are obtained from the experimental result shown in Figure 11: (1) The lower-dimensional topic representation is a good feature for article quality evaluation and it is effective in boosting the performance; (2) Supervised LDA outperforms LDA since it incorporates quality signals in its generative process and the resultant topic space is more effective for this particular task.

## 8.2 Semantic Matching

Another paradigm is semantic matching, which can be further categorized as short-short text matching, short-long text matching and long-long text matching.

**8.2.1 Short-Short Text Matching.** The need for short-short text matching is common in web search, where we need to compute the semantic similarity between queries and web page titles. Due to the difficulty of topic modeling on short text, embedding-based models such as Word2Vec and Topical Word Embeddings (TWE) are much more common for this task. Assume we want to compute the semantic similarity between a query  $q$  = “recommend good movies” and a web page title  $t$  = “2016 good movies in China”, we first convert the queries into their embeddings (i.e.,  $\vec{q}$  and  $\vec{t}$ ) and then compute the semantic similarity between these embeddings with the metric of cosine similarity.





Fig. 12. Semantic Matching of Query-Ad

$$\text{CosineSimilarity}(\vec{q}, \vec{t}) = \frac{\vec{q} \cdot \vec{t}}{|\vec{q}| |\vec{t}|} \quad (18)$$

There are more sophisticated short-short text matching mechanisms in literature, interested readers may refer to deep neural network based models such as Deep Structured Semantic Model (DSSM) [12] and Convolutional Latent Semantic Model (CLSM) [30].

**8.2.2 Short-Long Text Matching.** In many online applications, we need to compute the semantic similarity between query and document. Since query is typically short and document content is much longer, short-long text matching is needed in this scenario. Due to the difficulty of topic inference on short text, we compute the probability of the short text generated from the topic distribution of the long text as follows:

$$\text{Similarity}(q, c) = \prod_{w \in q} \sum_k P(w|z_k) P(z_k|c), \quad (19)$$

where  $q$  stands for query,  $c$  for document content,  $w$  for words in query and  $z_k$  for topics.

We first discuss the task of **online advertising**, in which we need to compute the semantic similarity between query and ad pages. We treat each textual field on ad page as a sentence and apply SentenceLDA for this task. After obtaining the topic distribution of each ad page, we apply Eq.(19) to compute the semantic similarity between query and the ad page. Such similarity can be utilized as a feature in downstream ranking models. For a query “recording of wedding ceremony”, we compare its ranking results from two strategies in Figure 12. We can see that the result with SentenceLDA feature is better at satisfying the underlying need of the query.

An extreme case of short-long text matching is the task of **keyword extraction from document**. We extract a set of keywords from documents as concise and explicit representation of the document. The conventional way of extracting keywords from texts relies upon the TF and IDF information. If we want to introduce the semantic importance, we can use Eq.(20) to compute the similarity of a word and the document as follows:

$$\text{Similarity}(w, c) = \sum_{k=1}^K \cos(\vec{v}_w, \vec{z}_k) P(z_k|c), \quad (20)$$

where  $c$  stands for document content,  $w$  for each word,  $\vec{v}_w$  for word embedding for word  $w$  and  $\vec{z}_k$  for vector representation of topic  $z$ . We use Eq.(20) to compute the similarity between each word and the whole article. Top-10 keywords (with stop words eliminated) extracted by TWE are shown in Figure 13, and we can see that the keywords from TWE preserve the important information in the news.

Word	Importance
抵制(Resistance)	0.1385
航空公司(Airline company)	0.1267
抗议(Protest)	0.1263
报道(Report)	0.1176
飞机(Aircraft)	0.1049
台湾(Taiwan)	0.1009
美国(USA)	0.0963
乘客(Customs)	0.0953
外媒(Foreign media)	0.0940
网友(Net friend)	0.0903

Fig. 13. Keyword Extraction based on TWE

**8.2.3 Long-Long Text Matching.** We can evaluate the semantic similarity between long texts by the distance of their topical distributions. Such semantic similarity can be further utilized as a feature in various machine learning models. The distance metrics of gauging two topical distributions include Hellinger Distance (HD) and Jensen-Shannon Divergence (JSD). Hellinger Distance is formally defined as follows:

$$HD(P, Q) = \frac{1}{\sqrt{2}} \sqrt{\sum_{i=1}^K (\sqrt{p_i} - \sqrt{q_i})^2}, \quad (21)$$

where  $p_i$  and  $q_i$  are the  $i$ -th element of the corresponding distributions. The definition of Jensen-Shannon Divergence (JSD) is as follows:

$$JSD(P||Q) = \frac{1}{2} (KLD(P||M) + KLD(Q||M)) \quad (22)$$

$$M = \frac{1}{2} (P + Q) \quad (23)$$

$$KLD(P||M) = \sum_{i=1}^K p_i \ln \frac{p_i}{m_i} \quad (24)$$

where  $KLD$  stands for Kullback-Leibler Divergence.

### 8.3 Application

We proceed to discuss the task of **personalized fiction recommendation**. Matrix factorization is a common approach for industrial recommendation systems. SVDFeature [4] is a framework designed to efficiently solve the feature-based matrix factorization. SVDFeature is quite flexible and is able to accommodate global features, user features and item features. SVDFeature can be mathematically described as follows:

$$y = \mu + \left( \sum_j b_j^{(g)} \gamma_j + \sum_j b_j^{(u)} \alpha_j + \sum_j b_j^{(i)} \beta_j \right) + \left( \sum_j p_j \alpha_j \right)^T \left( \sum_j q_j \beta_j \right), \quad (25)$$

where  $y$  is target,  $\mu$  is a constant indicating the global mean value of target,  $\alpha$  represents user feature,  $\beta$  represents item feature,  $\gamma$  represents global feature,  $b^{(g)}$  is weight of global feature,  $b^{(u)}$  is weight of user feature,  $b^{(i)}$  is weight of item feature,  $p$  and  $q$  are model parameters.

In the scenario of personalized fiction recommendation, each user has some historically downloaded fictions. By conduct topic modeling on these fictions, we can obtain the user's topic representation, which works as a user profile of reading interests. By computing the JSD between the topic distribution of each fiction and the user profile, we can quantify the probability that user is interested in this fiction. We augment the aforementioned SVDFeature framework with the JSD value as a global feature (Figure 14). From a comparative study shown in Figure 15, we can see that

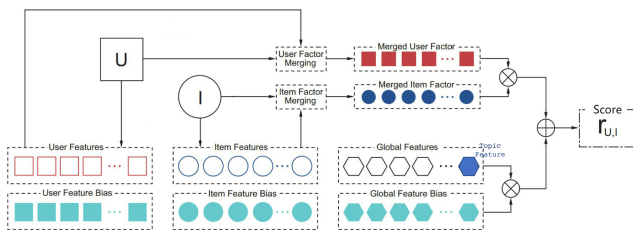

Fig. 14. SVDFeature with Topic Feature

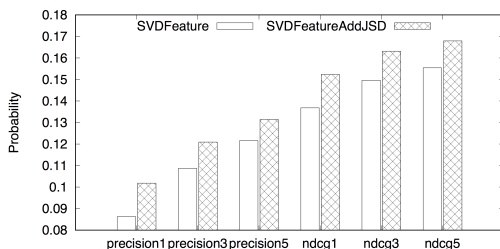

Fig. 15. Fiction Recommendation Performance

adding JSD is effective to improve the performance of SVDFeature. SVDFeature with JSD constantly outperform its original counterpart in terms of both Precision and NDCG.

## 9 CONCLUSION

In this paper, we propose a configurable topic modeling framework named Familia for industrial text engineering. The framework provides novel functionalities such as topic model customization, automatic parameter inference and post-modeling utilities. Based on the hybrid sampling mechanism of Familia, we further provide practical suggestions of choosing proper sampling methods for different topic models. Equipped with Familia, software engineers can easily test different assumptions of the latent structure of their data without tediously deriving mathematical equations and implementing sampling algorithms from scratch. We wish that Familia would help the technique of topic modeling to be utilized in more proper and convenient manner in industrial scenarios.

## REFERENCES

- [1] David M Blei, Andrew Y Ng, and Michael I Jordan. 2003. Latent dirichlet allocation. *the Journal of machine Learning research* 3 (2003), 993–1022.
- [2] Alexey Borisov, Pavel Serdyukov, and Maarten de Rijke. 2016. Using Metafeatures to Increase the Effectiveness of Latent Semantic Models in Web Search. In *Proceedings of the 25th International Conference on World Wide Web*. International World Wide Web Conferences Steering Committee, 1081–1091.
- [3] Jianfei Chen, Kaiwei Li, Jun Zhu, and Wenguang Chen. 2016. WarpLDA: a Cache Efficient O (1) Algorithm for Latent Dirichlet Allocation. *stat* 1050 (2016), 2.
- [4] Tianqi Chen, Weinan Zhang, Qiuxia Lu, Kailong Chen, Zhao Zheng, and Yong Yu. 2012. Svdfeature: a toolkit for feature-based collaborative filtering. *Journal of Machine Learning Research* 13, Dec (2012), 3619–3622.
- [5] Jeffrey Dean, Greg Corrado, Rajat Monga, Kai Chen, Matthieu Devin, Mark Mao, Andrew Senior, Paul Tucker, Ke Yang, Quoc V Le, and others. 2012. Large scale distributed deep networks. In *Advances in neural information processing systems*. 1223–1231.
- [6] Jerome H Friedman. 2002. Stochastic gradient boosting. *Computational Statistics & Data Analysis* 38, 4 (2002), 367–378.
- [7] Jianfeng Gao, Kristina Toutanova, and Wen-tau Yih. 2011. Clickthrough-based latent semantic models for web search. In *Proceedings of the 34th international ACM SIGIR conference on Research and development in Information Retrieval*.

ACM, 675–684.

- [8] Thomas L Griffiths and Mark Steyvers. 2004. Finding scientific topics. *Proceedings of the National academy of Sciences* 101, suppl 1 (2004), 5228–5235.
- [9] Geoffrey E. Hinton and Drew Van Camp. 1993. Keeping the neural networks simple by minimizing the description length of the weights. In *Proceedings of COLT-93*. 5–13.
- [10] Matthew D Hoffman, David M Blei, Chong Wang, and John Paisley. 2013. Stochastic variational inference. *Computer Science* 14, 1 (2013), 1303–1347.
- [11] Thomas Hofmann. 1999. Probabilistic latent semantic indexing. In *Proceedings of the 22nd annual international ACM SIGIR conference on Research and development in information retrieval*. ACM, 50–57.
- [12] Po-Sen Huang, Xiaodong He, Jianfeng Gao, Li Deng, Alex Acero, and Larry Heck. 2013. Learning deep structured semantic models for web search using clickthrough data. In *Proceedings of the 22nd ACM international conference on Conference on information & knowledge management*. ACM, 2333–2338.
- [13] Tommi S. Jaakkola and Michael I. Jordan. 1996. A variational approach to Bayesian logistic regression models and their extensions. (1996).
- [14] Jagadeesh Jagarlamudi and Jianfeng Gao. 2013. Modeling click-through based word-pairs for web search. In *Proceedings of the 36th international ACM SIGIR conference on Research and development in information retrieval*. ACM, 483–492.
- [15] Di Jiang, Zeyu Chen, Rongzhong Lian, Siqi Bao, and Chen Li. 2017. Familia: An Open-Source Toolkit for Industrial Topic Modeling. *arXiv preprint arXiv:1707.09823* (2017).
- [16] Yohan Jo and Alice H Oh. 2011. Aspect and sentiment unification model for online review analysis. In *Proceedings of the fourth ACM international conference on Web search and data mining*. ACM, 815–824.
- [17] Michael I. Jordan, Zoubin Ghahramani, Tommi S. Jaakkola, and Lawrence K. Saul. 1999. An Introduction to Variational Methods for Graphical Models. *Machine Learning* 37, 2 (1999), 183–233.
- [18] Diederik P Kingma and Max Welling. 2013. Auto-Encoding Variational Bayes. (2013).
- [19] Aaron Q Li, Amr Ahmed, Sujith Ravi, and Alexander J Smola. 2014. Reducing the sampling complexity of topic models. In *Proceedings of the 20th ACM SIGKDD international conference on Knowledge discovery and data mining*. ACM, 891–900.
- [20] Mu Li, Li Zhou, Zichao Yang, Aaron Li, Fei Xia, David G Andersen, and Alexander Smola. 2013. Parameter server for distributed machine learning. In *Big Learning NIPS Workshop*, Vol. 6. 2.
- [21] Jianhua Lin. 1991. Divergence measures based on the Shannon entropy. *IEEE Transactions on Information theory* 37, 1 (1991), 145–151.
- [22] Zhiyuan Liu, Yuzhou Zhang, Edward Y Chang, and Maosong Sun. 2011. Plda+: Parallel latent dirichlet allocation with data placement and pipeline processing. *ACM Transactions on Intelligent Systems and Technology (TIST)* 2, 3 (2011), 26.
- [23] Jon D McAuliffe and David M Blei. 2008. Supervised topic models. In *Advances in neural information processing systems*. 121–128.
- [24] David Newman, Arthur Asuncion, Padhraic Smyth, and Max Welling. 2009. Distributed algorithms for topic models. *Journal of Machine Learning Research* 10, Aug (2009), 1801–1828.
- [25] C Peterson. 1987. a mean field theory learning algorithm for neural network. *Complex Systems* 1, 3 (1987), 995–1019.
- [26] Ian Porteous, David Newman, Alexander Ihler, Arthur Asuncion, Padhraic Smyth, and Max Welling. 2008. Fast collapsed gibbs sampling for latent dirichlet allocation. In *Proceedings of the 14th ACM SIGKDD international conference on Knowledge discovery and data mining*. ACM, 569–577.
- [27] Rajesh Ranganath, Sean Gerrish, and David M Blei. 2013. Black Box Variational Inference. *Computer Science* (2013), 814–822.
- [28] Radim Řehůřek and Petr Sojka. 2010. Software Framework for Topic Modelling with Large Corpora. In *Proceedings of the LREC 2010 Workshop on New Challenges for NLP Frameworks*. ELRA, Valletta, Malta, 45–50. <http://is.muni.cz/publication/884893/en>.
- [29] Lawrence K. Saul and Michael I. Jordan. 1995. Exploiting Tractable Substructures in Intractable Networks. *Advances in Neural Information Processing Systems* 8 (1995), 486–492.
- [30] Yelong Shen, Xiaodong He, Jianfeng Gao, Li Deng, and Grégoire Mesnil. 2014. A latent semantic model with convolutional-pooling structure for information retrieval. In *Proceedings of the 23rd ACM International Conference on Conference on Information and Knowledge Management*. ACM, 101–110.
- [31] Xiance Si, Edward Y Chang, Zoltán Gyöngyi, and Maosong Sun. 2010. Confucius and its intelligent disciples: integrating social with search. *Proceedings of the VLDB Endowment* 3, 1-2 (2010), 1505–1516.
- [32] Sergej Sizov. 2010. Geofolk: latent spatial semantics in web 2.0 social media. In *Proceedings of the third ACM international conference on Web search and data mining*. ACM, 281–290.
- [33] Jan Vosecky, Di Jiang, Kenneth Wai-Ting Leung, Kai Xing, and Wilfred Ng. 2014. Integrating social and auxiliary semantics for multifaceted topic modeling in Twitter. *ACM Transactions on Internet Technology (TOIT)* 14, 4 (2014), 27.
- [34] Chong Wang, Jinggang Wang, Xing Xie, and Wei-Ying Ma. 2007. Mining geographic knowledge using location aware

- topic model. In *Proceedings of the 4th ACM workshop on Geographical information retrieval*. ACM, 65–70.
- [35] Xuerui Wang and Andrew McCallum. 2006. Topics over time: a non-Markov continuous-time model of topical trends. In *Proceedings of the 12th ACM SIGKDD international conference on Knowledge discovery and data mining*. ACM, 424–433.
- [36] Yi Wang, Xuemin Zhao, Zhenlong Sun, Hao Yan, Lifeng Wang, Zhihui Jin, Liubin Wang, Yang Gao, Jia Zeng, Qiang Yang, and others. 2014. Towards topic modeling for big data. *ACM Transactions on Intelligent Systems and Technology* 9, 4 (2014).
- [37] Xing Wei and W Bruce Croft. 2006. LDA-based document models for ad-hoc retrieval. In *Proceedings of the 29th annual international ACM SIGIR conference on Research and development in information retrieval*. ACM, 178–185.
- [38] Eric P Xing, Qirong Ho, Wei Dai, Jin Kyu Kim, Jinliang Wei, Seunghak Lee, Xun Zheng, Pengtao Xie, Abhimanu Kumar, and Yaoliang Yu. 2015. Petuum: A new platform for distributed machine learning on big data. *IEEE Transactions on Big Data* 1, 2 (2015), 49–67.
- [39] Limin Yao, David Mimno, and Andrew McCallum. 2009. Efficient methods for topic model inference on streaming document collections. In *Proceedings of the 15th ACM SIGKDD international conference on Knowledge discovery and data mining*. ACM, 937–946.
- [40] Jinhui Yuan, Fei Gao, Qirong Ho, Wei Dai, Jinliang Wei, Xun Zheng, Eric Po Xing, Tie-Yan Liu, and Wei-Ying Ma. 2015. Lightlda: Big topic models on modest computer clusters. In *Proceedings of the 24th International Conference on World Wide Web*. International World Wide Web Conferences Steering Committee, 1351–1361.