

Robust and Resource Efficient Identification of Shallow Neural Networks by Fewest Samples

Massimo Fornasier*, Jan Vybíral† and Ingrid Daubechies‡

February 23, 2022

Abstract

We address the structure identification and the uniform approximation of sums of ridge functions $f(x) = \sum_{i=1}^m g_i(\langle a_i, x \rangle)$ on \mathbb{R}^d , representing a general form of a shallow feed-forward neural network, from a small number of query samples. Higher order differentiation, as used in our constructive approximations, of sums of ridge functions or of their compositions, as in deeper neural network, yields a natural connection between neural network weight identification and tensor product decomposition identification. In the case of the shallowest feed-forward neural network, second order differentiation and tensors of order two (i.e., matrices) suffice as we prove in this paper. We use two sampling schemes to perform approximate differentiation - active sampling, where the sampling points are universal, actively, and randomly designed, and passive sampling, where sampling points were preselected at random from a distribution with known density. Based on multiple gathered approximated first and second order differentials, our general approximation strategy is developed as a sequence of algorithms to perform individual sub-tasks. We first perform an active subspace search by approximating the span of the weight vectors a_1, \dots, a_m . Then we use a straightforward substitution, which reduces the dimensionality of the problem from d to m . The core of the construction is then the stable and efficient approximation of weights expressed in terms of rank-1 matrices $a_i \otimes a_i$, realized by formulating their individual identification as a suitable nonlinear program. We prove the successful identification by this program of weight vectors being close to orthonormal and we also show how we can constructively reduce to this case by a whitening procedure, without loss of any generality. We finally discuss the implementation and the performance of the proposed algorithmic pipeline with extensive numerical experiments, which illustrate and confirm the theoretical results.

Keywords: training shallow neural networks, breaking the curse of dimensionality, randomized algorithms, whitening, nonlinear programming for optimizations in matrix subspaces

AMS subject classification (MSC 2010): 82C32, 92B20, 65D15, 60B20

*Department of Mathematics, TU München, Boltzmannstr. 3, D-85748 Garching bei München, Germany, massimo.fornasier@ma.tum.de; this author was supported by the DFG Grant FO767/6-2 “Lern- und Wiederherstellungsalgorithmen fuer Multi-Sensor Datenfusion und spektrales Entmischen in der Erdbeobachtung”.

†Department of Mathematics FNSPE, Czech Technical University in Prague, Trojanova 13, 12000 Prague, Czech Republic, jan.vybiral@fjfi.cvut.cz; this author was supported by the grant P201/18/00580S of the Grant Agency of the Czech Republic, by the Neuron Fund for Support of Science and by the European Regional Development Fund-Project “Center for Advanced Applied Science” (No. CZ.02.1.01/0.0/0.0/16.019/0000778)

‡Department of Mathematics, Duke University, NC, USA, ingrid.daubechies@duke.edu

Contents

1	Introduction and main results	2
1.1	Introduction	2
1.2	Ridge functions and tensor decompositions	3
1.3	Outline of the approach	6
1.4	Main result of the paper	8
2	Active subspace identification	10
2.1	Active sampling	10
2.2	Passive sampling	14
3	Dimensionality reduction	16
4	Principal Hessian subspace	17
4.1	Active sampling	17
4.2	Passive sampling	20
5	Near orthonormality	21
6	Identification of weights	25
6.1	Characterization of local maximizers	25
6.2	Approximation of weights	31
6.3	A gradient-ascent algorithm	38
7	Recovering the activation functions	43
8	Whitening	45
8.1	Exact whitening	45
8.2	Perturbed whitening	47
8.3	Finding positive definite matrices	48
8.4	Bootstrap whitening	49
9	Numerical experiments	50
9.1	Exact weight identification	51
9.2	Exploring computational time	52
9.3	Exploring memory allocation	53
9.4	Comparison to gradient descent	54
10	Appendix	55
10.1	Proofs of passive sampling results	55
10.2	Stability of the singular value decomposition	59
10.3	Spectral estimates and sums of random semidefinite matrices	60

1 Introduction and main results

1.1 Introduction

In the last decade, deep neural networks (NN) outperformed other pattern recognition methods, achieving even superhuman skills in some domains [12, 37, 58]. In the meanwhile,

the success of NNs has been further confirmed in speech recognition [24], optical character recognition [7], games solution [48, 56] and many other areas. Unfortunately, training a neural network usually involves a non-convex optimization and the process may get stuck at one of the many of its local minimizers. Furthermore, due to the huge number of parameters of multi-layer NNs and the multitude of local minimizers, the performance of a neural network is often difficult to explain and interpret. This black-box feature makes often NNs not the first-choice machine learning method in those areas, where interpretability is a crucial issue (like security, cf. [10]) or for those applications where one wants to extract new insights from data [63].

It is therefore of interest to know, which neural networks can be uniquely determined in a stable way by finitely many training points. In fact, the unique identifiability is clearly a form of interpretability. The motivating problem of this paper is the robust and resource efficient training of feed forward neural networks [29, 30]. Unfortunately, it is known that training a very simple (but general enough) neural network is indeed NP-hard [4, 34]. Even without invoking fully connected neural networks, recent work [22, 44] showed that even the training of one single neuron (ridge function or single index model) can show any possible degree of intractability. Recent results [3, 35, 45, 57, 62], on the other hand, are more encouraging, and show that minimizing a square loss of a (deep) neural network does not have in general or asymptotically (for large number of neurons) poor local minima, although it may retain the presence of critical saddle points.

In this paper we present conditions for a shallow neural network to be provably and constructively identifiable with a number of samples, which is polynomially depending on the dimension of the network. Moreover, we prove that our procedure is robust to perturbations. Our results hold with uniform approximation. For the implementation we do not require high dimensional optimization methods and no concerns about complex energy loss landscapes need to be addressed, but only classical and relatively simple calculus and linear algebra tools are used (mostly function differentiation and singular value decompositions).

The notation used throughout the paper is rather standard. For $0 < p < \infty$, we denote by $\|x\|_p = \left(\sum_{j=1}^d |x_j|^p\right)^{1/p}$ the p -(quasi)-norm of a vector $x \in \mathbb{R}^d$. This notation is complemented by setting $\|x\|_\infty = \max_{j=1,\dots,d} |x_j|$. If $M \in \mathbb{R}^{m \times d}$ is an $m \times d$ matrix, we denote by $\|M\|_F$ the Frobenius norm and by $\|M\|$ the spectral norm of M . The inner product of two vectors $x, y \in \mathbb{R}^d$ is denoted by $\langle x, y \rangle = x^T y$. Their tensor product is a rank-1 matrix denoted by $x \otimes y = xy^T$. For any subspace A of vectors or matrices, we denote P_A the orthogonal projection onto A . More specific notation is introduced along the way, when needed.

1.2 Ridge functions and tensor decompositions

We focus in particular on shallow feed forward neural networks

$$\sum_{i=1}^m \alpha_i \sigma \left(\sum_{j=1}^m w_{ij} x_j + \theta_i \right), \quad (1.1)$$

which constitute the main building blocks of deeper nets. To approach this problem, we study the more general task of the identification from minimal point queries of sums of ridge functions of the type

$$\sum_{i=1}^m g_i(\langle a_i, x \rangle), \quad x \in \mathbb{R}^d, \quad (1.2)$$

for some functions $g_i : \mathbb{R} \rightarrow \mathbb{R}$ and some non-zero vectors $a_i \in \mathbb{R}^d$. We assume that the functions g_i and the weights (or ridge directions) a_i 's are both unknown. Ridge function approximation has been extensively studied in mathematical statistics under the name of *projection pursuit*, see for instance [19, 31, 40]. The identification of sums of ridge functions has also been thoroughly considered in the approximation theory [9, 13, 14, 15, 17, 22, 41, 42, 43, 44, 52, 53], in particular we mention the work [8], where higher order differentiation was used to “extract” from the function f and “test” its principal directions a_i 's against some given vectors c_j 's:

$$D_{c_1}^{\alpha_1} \dots D_{c_k}^{\alpha_k} f(x) = \sum_{i=1}^m g_i^{(\alpha_1 + \dots + \alpha_k)}(\langle a_i, x \rangle) \langle a_i, c_1 \rangle^{\alpha_1} \dots \langle a_i, c_k \rangle^{\alpha_k},$$

where $k \in \mathbb{N}$, $c_i \in \mathbb{R}^d$, $\alpha_i \in \mathbb{N}$ for all $i = 1, \dots, k$ and $D_{c_i}^{\alpha_i}$ is the α_i -th derivative in the direction c_i . Hence, differentiation establishes a direct link between identification of the weights a_i 's and tensor decompositions [25]. Interestingly, [47] shows that learning the weights of a simple neural network (which essentially coincides with (1.2)) is as hard as the problem of decomposition of a tensor built up from these weights.

In order to avoid instability due to numerical differentiation and active sampling (active choice of point queries), “weak differentiation” approaches have been proposed. Let us describe the main ideas: Given an empirical sampling of points $x_k \sim \mu$ according to a probability distribution μ , several methods, such as Stein’s lemma and differentiation by parts with respect to known density $p(x)$ of μ [33, 40], have been considered to build from point queries empirical approximations to tensors corresponding to the expected value of higher order derivatives, for instance

$$\begin{aligned} \Delta_N^k(f) &= \frac{1}{N} \sum_{l=1}^N f(x_l) (-1)^k \frac{\nabla^k p(x_l)}{p(x_l)} \approx \int_{\mathbb{R}^d} f(x) (-1)^k \frac{\nabla^k p(x)}{p(x)} p(x) dx \\ &= \int_{\mathbb{R}^d} \nabla^k f(x) d\mu(x) = \mathbb{E}_{x \sim \mu}[\nabla^k f] \\ &= \sum_{i=1}^m \left(\int_{\mathbb{R}^d} g^{(k)}(\langle a_i, x \rangle) d\mu(x) \right) \underbrace{a_i \otimes \dots \otimes a_i}_{k\text{-times}}. \end{aligned} \quad (1.3)$$

In the case of second order tensors, i.e., $k = 2$ this approach comes under the name of *principal Hessian directions* [40]. This case is particularly relevant, because it deals with empirical approximation of matrices of the type

$$\Delta_N^2(f) \approx \sum_{i=1}^m \int_{\mathbb{R}^d} g''(\langle a_i, x \rangle) d\mu(x) a_i \otimes a_i.$$

In case of orthogonal weights a_i 's and $m \leq d$, the identification of the weights is in principle solvable by spectral decomposition. However, this method leaves open the issue of dealing with non-orthogonal weights and the overdetermined case of $m > d$. In order to tackle both these issues the idea has been extended to third order tensors ($k = 3$) and tensor decompositions. Using precisely the approximation (1.3), in the recent paper [33] the authors proposed and analyzed the algorithm NN-LIFT, which learns a two-layer feed-forward neural network, where the second layer has a linear activation function. These results build upon the work [2] where symmetric non-orthogonal tensor decompositions are

shown to be tractably computable. The non-orthogonal case is in fact addressed by reducing it via an orthogonalization procedure, called *whitening*, to the symmetric orthogonal tensor decomposition, which is known to be tractable [36, 61].

The approaches based on the approximation (1.3), e.g., both the principal Hessian directions [40] and the recent one in [33] for third order tensors, may suffer from a significant drawback: they are based on the decomposition of *one single instance matrix/tensor*, which is the empirical approximation to the expected value of (higher order) weak derivatives. In fact, it is well known that spectral and tensor decompositions are in general unstable processes, unless spectral gaps and well-conditioning are guaranteed [60]. The error estimates appearing in [40, 33] look very similar, see, e.g., [40, Theorem 4.1] and [33, Theorem 3, formula (12) or Lemma 9, Lemma 10], and contain inverse proportional terms with respect to eigenvalues or tensor coefficients (with higher order power in the case of tensors), on which no control can be provided, unless one assumes well-conditioning a priori. In other words, if the one matrix/tensor at hand happens to have unstable decomposition, then one is simply left with bad luck. One may argue that this situation may generically not occur, but no proof is provided so far.

Another drawback of [40], as mentioned above, is that the approach via principal Hessian directions cannot deal with non-orthogonal weights. In the paper [33] the authors claim that, while a matrix decomposition is only identifiable up to orthogonal components, tensors can have identifiable non-orthogonal components and use this argument to motivate the necessity of the complexity and potential higher instability of third order tensors. Unfortunately, the low-rank tensor decomposition problem is usually not well-posed [16]. (This is based on the result that there are rank- $(r + 1)$ tensors in the closure of rank- r tensors.) Nonetheless, in certain regimes and under certain assumptions, also for m -rank tensors with $m > d$ and without assumptions of near-orthonormality, it is uniquely solvable. A very helpful characterization of the regime where tensor decomposition is a well-posed problem can be given in terms of the generic rank $r_{gen}(d, s)$: if $m \leq r_{gen}(d, s) := \frac{1}{d+1} \binom{d+s}{s}$ then with the exception of nongeneric cases, every m -rank s -tensor in \mathbb{R}^d has a unique rank- m decomposition (up to rescaling); moreover there are algorithms to find such a decomposition, mainly based on algebraic methods [11, 46, 50], whose stability under perturbation is presently not known.

In this paper we approach the problem of the weight identification by using a robust procedure, which does not suffer from the potential instabilities of being based on a single matrix/tensor instance as in [33, 40]. Moreover, we disprove the claim that it is necessary to use higher order tensors in order to deal with non-orthogonal weights: in fact, by developing an appropriate whitening procedure, we will exclusively build our identification procedure on matrices, making our approach resource efficient and potentially more stable than tensor technology, which is in general more susceptible to intractability and instabilities [16, 27, 28]. Also in our error estimates, see, e.g., (2.13), (4.10), we require inverse proportional terms with respect to conditioning of the problem encoded by constants α, α_2 , which we will introduce below; however, as we use a lower order differentiation and matrices (not tensors), the power magnitude of these terms is smaller than for higher order differentiations and tensors as in, e.g., [33, Theorem 3, formula (12) or Lemma 9, Lemma 10], where such terms appear even at the sixth power. In this paper we focus on the case of $m \leq d$, i.e., when the number of neurons m is at most equal to the underlying dimension d . In [21] we are addressing the overdetermined case of $m > d$ and of two hidden layer¹ feed-forward neural

¹In view of a certain ambiguity in the literature, we clarify that, for two hidden layers, we mean here one

networks.

1.3 Outline of the approach

The aim of this paper is the structure identification and uniform approximation of sums of ridge functions

$$f(x) = \sum_{i=1}^m g_i(\langle a_i, x \rangle), \quad x \in B_1^d = \{x \in \mathbb{R}^d : \|x\|_2 \leq 1\}. \quad (1.4)$$

We assume throughout that the vectors $a_1, \dots, a_m \in \mathbb{R}^d$ are linearly independent and, therefore, $m \leq d$. Nevertheless, the typical setting we have in mind is that the number $d \gg 1$ of variables is very large and the number m of summands in (1.4) might be much smaller than d , i.e. $m \ll d$.

Sections 2-7 address the identification of (1.4) under the assumption that $\{a_1, \dots, a_m\}$ are close to an orthonormal basis. In Section 8 (see also Remark 1) we show how this assumption can be removed without any loss of generality. Our approach is based on the following fundamental steps, which will be realized in a robust constructive/algorithmic way:

1. **(Active subspace)** By using pointwise evaluations of the network f we approximate (strong or weak) gradients, e.g.,

$$\nabla f(x) = \sum_{i=1}^m g'_i(\langle a_i, x \rangle) a_i \in A = \text{span} \{a_1, \dots, a_m\},$$

at different points x , and we construct by Algorithm 2.1 an approximating space $\tilde{A} \approx A$, see Theorem 2.2 or Theorem 2.3 in Section 2.

2. **(Dimensionality reduction)** We recall that in this paper $m \leq d$. First of all, we show that we can reduce the problem to the case of $d = m$. Let us choose any orthonormal basis of \tilde{A} and arrange it as the columns of a matrix $\tilde{A} \in \mathbb{R}^{d \times m}$ with some abuse of notation. Then

$$f(x) \approx f(P_{\tilde{A}}x) = f(\tilde{A}\tilde{A}^T x).$$

We define the lower dimensional network

$$\tilde{f}(y) := f(\tilde{A}y) : \mathbb{R}^m \rightarrow \mathbb{R},$$

which has weights $\alpha_1 = \tilde{A}^T a_1, \dots, \alpha_m = \tilde{A}^T a_m$. Note that $\tilde{A}\alpha_i = P_{\tilde{A}}a_i \approx a_i$, and therefore a_i can be approximately recovered from α_i . In summary, if the active subspace A of f is approximately known, then we can construct \tilde{f} , such that the identification of f and \tilde{f} are equivalent. Hence, as we show in more details in Theorem 3.1 of Section 3, without loss of generality we can assume that f maps \mathbb{R}^m to \mathbb{R} and that $a_i \in \mathbb{R}^m$.

more fully nonlinear layer with respect to (1.1).

3. **(Principal Hessian space)** While first order differentiation provides information about the active subspace $\mathcal{A} = \text{span}\{a_1, \dots, a_m\}$, we need to query higher order derivatives in order to access the individual weights a_1, \dots, a_m . Again by pointwise evaluations of the network f we approximate (strong or weak) Hessians and we construct by Algorithm 4.1 an approximating space $\tilde{\mathcal{A}}$ of $\mathcal{A} = \text{span}\{a_i \otimes a_i, i = 1, \dots, m\} \subset \mathbb{R}^{m \times m}$. The approximation results are collected in Theorem 4.2 and Theorem 4.3 in Section 4.
4. **(Individual weight recovery)** Once the space $\tilde{\mathcal{A}} \approx \mathcal{A}$ is constructed, the robust approximation of the weights a_1, \dots, a_m is reduced to the problem of identifying near rank-1 matrices in $\tilde{\mathcal{A}}$. In Section 6 we solve the problem under the assumption that the weights $\{\tilde{a}_i : i = 1, \dots, m\}$ are close to orthonormal. In that case, the geometry of the space $\tilde{\mathcal{A}} \approx \mathcal{A} = \text{span}\{a_i \otimes a_i, i = 1, \dots, m\} \subset \mathbb{R}^{m \times m}$ can be described by the following Euclidean representation:

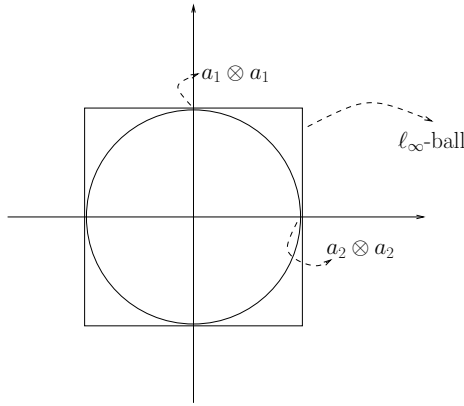

Figure 1: If $a_i \otimes a_i$ were orthonormal then they would also be the extremal points of the matrix operator norm in the Frobenius ball of \mathcal{A} .

We therefore consider the following robust nonconvex program

$$\arg \max \|M\|, \quad \text{s.t.} \quad M \in \tilde{\mathcal{A}}, \|M\|_F \leq 1,$$

searching for extremal matrices of the operator norm within the Frobenius ball, and we prove with Theorem 6.5 that its (local) maximizing solutions have first singular vectors \hat{a}_i which are approximations to any one a_i up to sign. Conversely, we also show in Proposition 6.7 that every $a_i \otimes a_i$ can be approximated by a local maximizer. The solution of this minimization problem is approached by an iterative gradient ascent-type algorithm, Algorithm 6.2, with Theorem 6.10 establishing its local convergence.

5. **(Identification of activation functions or ridge profiles)** Once the weights are recovered (up to sign) it is not hard to build approximating ridge profiles \hat{g}_i and construct an approximation \hat{f} of the full network. The construction is summarized as follows: Let $(\hat{b}_j)_{j=1}^m$ be the dual basis to $(\hat{a}_j)_{j=1}^m$, then one can define $\hat{g}_j(t) := f(t\hat{b}_j)$, $t \in (-1/\|\hat{b}_j\|_2, 1/\|\hat{b}_j\|_2)$ and $\hat{f}(x) := \sum_{j=1}^m \hat{g}_j(\langle \hat{a}_j, x \rangle)$. We show in the concluding Theorem 7.2 that \hat{f} is a good uniform approximation to the original network.

Remark 1. (Whitening) As we have seen in the step 4, the problem of the identification of near rank-1 matrices in $\tilde{\mathcal{A}} \approx \mathcal{A} = \text{span}\{a_i \otimes a_i, i = 1, \dots, m\} \subset \mathbb{R}^{m \times m}$ is greatly simplified if one can assume that $\{a_1, \dots, a_m\}$ are nearly orthonormal vectors. If this condition is not fulfilled, we propose an additional step called *whitening*, which may be evoked between the steps 3 and 4 above. Indeed, we prove in Section 8 that, without loss of generality, we can always assume that the weights are nearly orthonormal. For this sake, we consider any positive definite matrix $\tilde{G} \in \tilde{\mathcal{A}}$ of $\|\tilde{G}\|_F = 1$ with maximal smallest eigenvalue and compute its singular value or spectral decomposition $\tilde{G} = \tilde{U}\tilde{D}\tilde{U}^T$. If we now denote $\tilde{W} = \tilde{D}^{-\frac{1}{2}}\tilde{U}^T$ the so-called *whitening matrix*, then we show in Theorem 8.3 that the system of vectors $\{\tilde{W}a_i : i = 1, \dots, m\}$ defines a near-orthogonal basis. In view of the simple reformulation

$$f(\tilde{W}^T x) = \sum_{i=1}^m g_i(\langle a_i, \tilde{W}^T x \rangle) = \sum_{i=1}^m \tilde{g}_i(\langle \tilde{W}a_i / \|\tilde{W}a_i\|_2, x \rangle) = \tilde{f}(x),$$

for $\tilde{g}_i(t) = g_i(\|\tilde{W}a_i\|_2 t)$, we can further assume without loss of generality that the vectors $\{a_i : i = 1, \dots, m\}$ are nearly orthonormal in first place.

1.4 Main result of the paper

At this point, it is worth to summarize all the construction through the different algorithms and intermediate results outlined above in a single higher level result, which we specify for the case of *active sampling*, exclusively for the sake of simplicity. A similar statement would hold also for the case of *passive sampling*, which allows for more generic distributions.

We introduce two matrices. First we shall assume that the matrix

$$J[f] := \int_{\mathbb{S}^{d-1}} \nabla f(x) \nabla f(x)^T d\mu_{\mathbb{S}^{d-1}}(x) \quad (1.5)$$

has maximal rank m , being $\mu_{\mathbb{S}^{d-1}}^2$ the uniform measure on the sphere \mathbb{S}^{d-1} . The matrix $J[f]$ ensures that sampling approximate gradients of the network f uniformly on the sphere is gathering enough information for the active subspace $\mathcal{A} = \text{span}\{a_1, \dots, a_m\}$ to be fully, robustly, and constructively identifiable by simple PCA. Then we consider also the matrix

$$H_2[f] := \int_{\mathbb{S}^{m-1}} \text{vec}(\nabla^2 f(x)) \otimes \text{vec}(\nabla^2 f(x)) d\mu_{\mathbb{S}^{m-1}}(x)$$

of rank m (the symbol $\text{vec}(\nabla^2 f(x))$ stands for the vectorization of the Hessian of f , see (4.2) for its precise definition). The matrix $H_2[f]$ also ensures that sampling approximate Hessians of the network f uniformly on the sphere is gathering enough information for the active subspace $\mathcal{A} = \text{span}\{a_1 \otimes a_1, \dots, a_m \otimes a_m\}$ to be fully, robustly, and constructively identifiable by simple PCA.

Theorem 1.1. *Let $m \leq d$ and let f be a real-valued function defined on the neighborhood of B_1^d , which takes the form*

$$f(x) = \sum_{i=1}^m g_i(\langle a_i, x \rangle),$$

²The use of the uniform measure on the sphere for active sampling is by no means a restriction, more general distributions could be used with no significant difference in the results.

where $g_i, i = 1, \dots, m$, are three times continuously differentiable on a neighborhood of $[-1, 1]$ and $\{a_1, \dots, a_m\} \subset \mathbb{R}^d$ are linearly independent. We additionally assume both $J[f]$ and $H_2[f]$ of maximal rank m and well-conditioned. Let $\epsilon > 0$. Then Algorithms 2.1-6.1 use at most $m_{\mathcal{X}}[(d+1) + (m+1)(m+2)/2]$ random exact point evaluations of f , which correspond to numerical differentiation of f with step-size ϵ , and they construct approximations $\{\hat{a}_1, \dots, \hat{a}_m\}$ of the ridge directions $\{a_1, \dots, a_m\}$ up to a sign change for which

$$\left(\sum_{i=1}^m \|\hat{a}_i - a_i\|_2^2 \right)^{1/2} \lesssim \epsilon, \quad (1.6)$$

with probability at least $1 - m \exp\left(-\frac{m_{\mathcal{X}}C}{2m^2}\right)$ for suitable $C > 0$. Moreover, Algorithm 7.1 constructs an approximating function $\hat{f} : B_1^d \rightarrow \mathbb{R}$ of the form

$$\hat{f}(x) = \sum_{i=1}^m \hat{g}_i(\langle \hat{a}_i, x \rangle),$$

such that

$$\|f - \hat{f}\|_{L_\infty(B_1^d)} \lesssim \epsilon. \quad (1.7)$$

The constant $C > 0$ as well as the asymptotic constants in (1.6) and (1.7) may depend on the smoothness properties of g_i and the m^{th} singular value of $J[f]$ and $H_2[f]$. Furthermore, the constants in (1.6) and (1.7) may depend also polynomially on m .

Let us remark, that Algorithms 2.1-6.1 realize the statement of Theorem 1.1 only when the vectors a_1, \dots, a_m are close to an orthonormal basis in the sense of Definition 5.1. If this is not the case, it might be necessary to perform also the whitening step of Section 8.

In absence of noise on the point evaluations of f as in Theorem 1.1, the usage of more point evaluations improves the accuracy in (1.6) and (1.7) only up to a limit posed by the numerical differentiation, but it increases the probability of success arbitrarily close to one. The result would need to be significantly modified in case of noise on the *active* point evaluations of f in order to deal with stability issues determined by employing finite differences in order to approximate the gradient and the Hessian of f . Contrary to most results available in the literature [3, 33, 45, 62], our final estimate (1.7) holds in the uniform norm, which is deterministic once the weights are correctly identified. In fact, probabilistic least squares error estimates usually investigated in the literature may appear to successfully circumvent the curse of dimensionality, but they are obtained at the practically relevant price of not ensuring uniform error bounds. Not only we avoid the curse of dimensionality, but we also do not compromise on the uniform bound.

In the setting of passive sampling, we assume that the values $f(x_1), \dots, f(x_{m_{\mathcal{X}}})$ were sampled in points $x_1, \dots, x_{m_{\mathcal{X}}}$, which are chosen independently with respect to a probability distribution μ on B_1^d . Here, we assume that its density $p(x)$ is smooth and known in advance. Using Stein's lemma [59] or integration by parts in a way similar to [33] and [40], we transfer our analysis also to the setting of passive sampling, leading first to the reduction of dimension from d to $m \leq d$ and then to the approximation of $\mathcal{A} = \text{span}\{a_1 \otimes a_1, \dots, a_m \otimes a_m\}$. Due to the non-local nature of the sampling process, it is rather easy to incorporate noise. Similarly to the active sampling, our main tools are the matrix concentration inequalities [1, 51, 55, 65].

We conclude this introduction by mentioning that this paper, besides the specific application on identification of shallow neural networks, contains results of independent mathematical and computational interest. First of all, we proved that stable whitening of matrices is constructively attainable, see Section 8. This seems to disprove a common belief in the literature, see, e.g., [33], that the use of third or higher order tensors can not be avoided. Moreover, we introduced a new nonconvex optimization (6.1) with no spurious local minimizers, which allows identifying robustly 1-rank matrices in linear subspaces of symmetric matrices, see Section 6 and Section 6.2. We provide a simple and efficient iterative algorithm to perform such an optimization, Section 6.3. Similar problems appeared recently in the literature and are of independent interest [49, 54].

2 Active subspace identification

As previously mentioned in the introduction, as soon as we can produce a subspace $\tilde{A} \subset \mathbb{R}^d$ approximating $A = \text{span}\{a_1, \dots, a_m\}$, we can eventually reduce the problem of approximating a sum of ridge functions in \mathbb{R}^d to the same problem in \mathbb{R}^m , preserving even the near-orthonormality, cf. Remark 5. In this section we describe two different methods of identification of A . The first one applies to the setting of active sampling. It is motivated by the results in [22] and makes use of first order differences. The second method is inspired by [33], and implements passive sampling under the assumption that we dispose of the probability density $p(x)$ of the point distribution of the samples.

2.1 Active sampling

We observe that the vector

$$\nabla f(x) = \sum_{i=1}^m g'_i(\langle a_i, x \rangle) a_i \quad (2.1)$$

lies in A for every $x \in \mathbb{R}^d$. We consider (2.1) for different $x_1, \dots, x_{m_\mathcal{X}} \in \mathbb{R}^d$, where $m_\mathcal{X} \geq m$. In a generic situation for the points x_i 's, A is likely given as the span of $\{\nabla f(x_1), \dots, \nabla f(x_{m_\mathcal{X}})\}$.

As we would like to use only function values of f in our algorithms, we use for every $j = 1, \dots, d$ and every $k = 1, \dots, m_\mathcal{X}$ the Taylor's expansion

$$\frac{\partial}{\partial e_j} f(x_k) = \frac{f(x_k + \epsilon e_j) - f(x_k)}{\epsilon} - \left[\frac{\partial}{\partial e_j} f(x_k + \eta_{j,k} e_j) - \frac{\partial}{\partial e_j} f(x_k) \right] \quad (2.2)$$

for some $\eta_{j,k} \in [0, \epsilon]$. We recast the $d \times m_\mathcal{X}$ instances of (2.2) into the matrix notation

$$X = Y - \mathcal{E}, \quad (2.3)$$

where

$$X_{j,k} = \frac{\partial}{\partial e_j} f(x_k), \quad Y_{j,k} = \frac{f(x_k + \epsilon e_j) - f(x_k)}{\epsilon}, \quad (2.4)$$

and

$$\mathcal{E}_{j,k} = \frac{\partial}{\partial e_j} f(x_k + \eta_{j,k} e_j) - \frac{\partial}{\partial e_j} f(x_k)$$

for $j = 1, \dots, d$ and $k = 1, \dots, m_{\mathcal{X}}$. It follows from (2.1), that A is the linear span of columns of X . Naturally, we define \tilde{A} using the linear span of the singular vectors of Y corresponding to its m largest singular values. This is formalized in the following algorithm.

Algorithm 2.1.

- Construct Y according to (2.4).
- Compute the singular value decomposition of

$$Y^T = \begin{pmatrix} \tilde{U}_1 & \tilde{U}_2 \end{pmatrix} \begin{pmatrix} \tilde{\Sigma}_1 & 0 \\ 0 & \tilde{\Sigma}_2 \end{pmatrix} \begin{pmatrix} \tilde{V}_1^T \\ \tilde{V}_2^T \end{pmatrix},$$

where $\tilde{\Sigma}_1$ contains the m largest singular values.

- Set \tilde{A} to be the row space of \tilde{V}_1^T .

The aim of the rest of this section is to show, that \tilde{A} constructed in Algorithm 2.1 is in some sense close to A . To be more specific, we need to bound $\|P_A - P_{\tilde{A}}\|$, i.e. the operator or the Frobenius norm of the difference between the orthogonal projections onto A and \tilde{A} , respectively. For this first approximation method we need the matrix $J[f]$, which was defined in (1.5) as

$$J[f] := \int_{\mathbb{S}^{d-1}} \nabla f(x) \nabla f(x)^T d\mu_{\mathbb{S}^{d-1}}(x).$$

In some sense, it captures the contribution of each term in (1.2). As we want to recover all ridge profiles, we assume that $J[f]$ has the maximal rank m and its non-zero singular values are bounded away from zero.

Lemma 2.1. *Assume the vectors $(a_i)_{i=1}^m$ linearly independent, and $\|a_i\|_2 = 1$ for all $i = 1, \dots, m$. Additionally assume*

$$C_1 := \max_{i=1, \dots, m} \max_{-1 \leq t \leq 1} |g_i'(t)| < \infty.$$

Suppose that $\sigma_m(J[f]) \geq \alpha > 0$, i.e., the m^{th} singular value of the matrix $J[f]$ is bounded away from zero. Then for any $s \in (0, 1)$ we have that

$$\sigma_m(X) \geq \sqrt{m_{\mathcal{X}} \alpha (1-s)} \tag{2.5}$$

with probability at least $1 - m \exp\left(-\frac{m_{\mathcal{X}} \alpha s^2}{2C_1^2 m^2}\right)$, where X is constructed as in (2.3) for $x_1, \dots, x_{m_{\mathcal{X}}} \in \mathbb{S}^{d-1}$ drawn uniformly at random.

Proof. The result will follow by a suitable application of Theorem 10.3 in the Appendix. We choose an orthonormal basis w_1, \dots, w_m of A and denote by W a $d \times m$ matrix with columns w_1, \dots, w_m . We observe that $\sigma_j(X) = \sigma_j(W^T X) = \sqrt{\sigma_j(W^T X X^T W)}$,

$$X X^T = \sum_{l=1}^{m_{\mathcal{X}}} \nabla f(x_l) \nabla f(x_l)^T$$

and

$$W^T X X^T W = \sum_{l=1}^{m_{\mathcal{X}}} W^T \nabla f(x_l) \nabla f(x_l)^T W.$$

Furthermore, we obtain for every $x \in \mathbb{R}^d$

$$\begin{aligned}
\sigma_1(W^T \nabla f(x) \nabla f(x)^T W) &= \sigma_1(\nabla f(x) \nabla f(x)^T) = \|\nabla f(x) \nabla f(x)^T\|_F \\
&= \|\nabla f(x)\|_2^2 = \left\| \sum_{i=1}^m g'_i(\langle a_i, x \rangle) a_i \right\|_2^2 \\
&\leq \left(\sum_{i=1}^m |g'_i(\langle a_i, x \rangle)| \cdot \|a_i\|_2 \right)^2 \leq C_1^2 m^2.
\end{aligned} \tag{2.6}$$

Hence $X_j = W^T \nabla f(x_j) \nabla f(x_j)^T W$ is a random $m \times m$ positive-semidefinite matrix, that is almost surely bounded. Moreover,

$$\mathbb{E} X_j = W^T \int_{\mathbb{S}^{d-1}} \nabla f(x) \nabla f(x)^T d\mu_{\mathbb{S}^{d-1}}(x) W = W^T J[f] W.$$

We conclude that $\mu_{\min} = \mu_{\min} \left(\sum_{j=1}^{m\chi} \mathbb{E} X_j \right) \geq m\chi\alpha$, and by Theorem 10.3 in the Appendix

$$\sigma_m(X) = \sqrt{\sigma_m(W^T X X^T W)} \geq \sqrt{\mu_{\min}(1-s)} \geq \sqrt{m\chi\alpha(1-s)}$$

with probability at least

$$1 - m \exp\left(-\frac{\mu_{\min}s^2}{2C_1^2 m^2}\right) \geq 1 - m \exp\left(-\frac{m\chi\alpha s^2}{2C_1^2 m^2}\right). \quad \square$$

Remark 2. If we further assume that a_1, \dots, a_m are ε -nearly-orthonormal and w_1, \dots, w_m are orthonormal vectors with

$$\mathcal{S}(a_1, \dots, a_m) = \left(\sum_{i=1}^m \|a_i - w_i\|_2^2 \right)^{1/2} \leq \varepsilon,$$

we can improve (2.6) to

$$\begin{aligned}
\sigma_1(W^T \nabla f(x) \nabla f(x)^T W) &\leq \|\nabla f(x)\|_2^2 = \left\| \sum_{i=1}^m g'_i(\langle a_i, x \rangle) a_i \right\|_2^2 \\
&\leq \left(\left\| \sum_{i=1}^m g'_i(\langle a_i, x \rangle) w_i \right\|_2 + \left\| \sum_{i=1}^m g'_i(\langle a_i, x \rangle) (a_i - w_i) \right\|_2 \right)^2 \\
&\leq \left[\left(\sum_{i=1}^m |g'_i(\langle a_i, x \rangle)|^2 \right)^{1/2} + \sum_{i=1}^m |g'_i(\langle a_i, x \rangle)| \cdot \|a_i - w_i\|_2 \right]^2 \\
&\leq (1 + \varepsilon)^2 \sum_{i=1}^m |g'_i(\langle a_i, x \rangle)|^2 \leq C_1^2 (1 + \varepsilon)^2 m.
\end{aligned}$$

The rest of the proof then follows in the same manner, only the probability changes to

$$1 - m \exp\left(-\frac{m\chi\alpha s^2}{2C_1^2 (1 + \varepsilon)^2 m}\right).$$

The same remark applies also to Theorem 4.2 below.

The following theorem quantifies the distance between the subspace \tilde{A} constructed in Algorithm 2.1 and A .

Theorem 2.2. *Assume the vectors $(a_i)_{i=1}^m$ linearly independent, and $\|a_i\|_2 = 1$ for all $i = 1, \dots, m$. Additionally assume that*

$$C_1 := \max_{i=1, \dots, m} \max_{-1 \leq t \leq 1} |g'_i(t)| < \infty$$

and that the Lipschitz constants of all $g'_j, j = 1, \dots, m$, are bounded by $C_2 < \infty$.

Let \tilde{A} be constructed as described in Algorithm 2.1 by sampling $m_{\mathcal{X}}(d+1)$ values of f . Let $0 < s < 1$, and assume $\sigma_m(J[f]) \geq \alpha > 0$. Then

$$\|P_A - P_{\tilde{A}}\|_F \leq \frac{2C_2\epsilon m}{\sqrt{\alpha(1-s)} - C_2\epsilon m}$$

with probability at least $1 - m \exp\left(-\frac{m_{\mathcal{X}}\alpha s^2}{2m^2 C_1^2}\right)$.

Proof. We intend to apply the so-called *Wedin's bound*, as recalled in Theorem 10.2 in the Appendix, to estimate the distance between A and \tilde{A} . If we choose $B = X^T$ and $\tilde{B} = Y^T$, we get $\Sigma_2 = 0$ and we observe that (10.8) and (10.9) are satisfied with $\bar{\alpha} = \sigma_m(Y^T)$. Therefore, Theorem 10.2 implies

$$\begin{aligned} \|P_A - P_{\tilde{A}}\|_F &= \|V_1 V_1^T - \tilde{V}_1 \tilde{V}_1^T\|_F \leq \frac{2\|X - Y\|_F}{\sigma_m(Y^T)} \\ &\leq \frac{2\|X - Y\|_F}{\sigma_m(X^T) - \|X - Y\|_F}, \end{aligned} \quad (2.7)$$

where we have used Weyl's inequality $|\sigma_m(X^T) - \sigma_m(Y^T)| \leq \|X - Y\|_F$ in the last step. To continue in (2.7), we have to estimate $\|X - Y\|_F$ and $\sigma_m(X^T)$.

We use the relation

$$\left| \frac{\partial}{\partial e_j} f(x_k + \eta_{j,k} e_j) - \frac{\partial}{\partial e_j} f(x_k) \right| = \left| \sum_{i=1}^m [g'_i(\langle a_i, x_k + \eta_{j,k} e_j \rangle) - g'_i(\langle a_i, x_k \rangle)] a_{i,j} \right| \leq C_2 \epsilon \sum_{i=1}^m a_{i,j}^2$$

to obtain the estimate

$$\begin{aligned} \|X - Y\|_F &= \|\mathcal{E}\|_F \leq C_2 \epsilon \left(\sum_{k=1}^{m_{\mathcal{X}}} \sum_{j=1}^d \left(\sum_{i=1}^m a_{i,j}^2 \right)^2 \right)^{1/2} \\ &\leq C_2 \epsilon \sqrt{m_{\mathcal{X}}} \sum_{j=1}^d \sum_{i=1}^m a_{i,j}^2 = C_2 \epsilon \sqrt{m_{\mathcal{X}}} m. \end{aligned} \quad (2.8)$$

The statement now follows by a combination of (2.7) with (2.8) and (2.5). \square

Remark 3. The same argument as in the proof of Theorem 2.2 allows to show that

$$\sigma_m(Y) - \sigma_{m+1}(Y) \geq \sqrt{m_{\mathcal{X}}} (\sqrt{\alpha(1-s)} - 2C_2\epsilon m)$$

with the same probability as before. Hence, for ϵ small enough and $m_{\mathcal{X}}$ large, there is (with high probability) a gap in the spectrum of Y between $\sigma_m(Y)$ and $\sigma_{m+1}(Y)$. This can be used to detect m if it is unknown.

2.2 Passive sampling

In the previous sections we investigated the identification of the subspace A when the sample points of $f(x)$ can be actively chosen. For that we used classical differentiation and Taylor's residuals and we assumed exact evaluations of the function. In this section, we discuss the approximation of A in the more realistic scenario where the distribution of the sampling points is known, but not actively chosen, and the point evaluations are affected by noise.

As in [33], we assume that we are given a probability distribution μ , whose density $p(x)$ is known or has been previously estimated from empirical data [18]. For simplicity we assume $\text{supp}(p) \subset B_1^d$. We also assume that we are given a probability space (\mathcal{V}, π) and a suitable collection of C_c^1 functions $\varphi_\nu : \mathbb{R}^d \rightarrow \mathbb{R}$, for $\nu \in \mathcal{V}$, with the properties

$$\text{supp } \varphi_\nu \subset B_1^d \text{ for all } \nu \in \mathcal{V}, \quad \max_{\nu \in \mathcal{V}} \max_{x \in B_1^d} \left\| \frac{\nabla \varphi_\nu(x)}{p(x)} \right\|_2 \leq C_{\mathcal{V}}, \quad (2.9)$$

and for which the matrix

$$J_{\mathcal{V}}[f] = \int_{\mathcal{V}} \left(\int_{\mathbb{R}^d} \nabla f(x) \varphi_\nu(x) dx \right) \left(\int_{\mathbb{R}^d} \nabla f(x) \varphi_\nu(x) dx \right)^T d\pi(\nu) \quad (2.10)$$

has rank m .

Remark 4. (i) The probability space (\mathcal{V}, π) , the set of functions $\{\varphi_\nu : \nu \in \mathcal{V}\}$, and the full-rank condition for $J_{\mathcal{V}}[f]$ may appear abstract and a bit implicit at the first look. We clarify their role first in the most simple setting when $m = 1$, $g(t) = t$ and $\mathcal{V} = \{0\}$. Then $f(x) = g(\langle a, x \rangle) = \langle a, x \rangle$ and (2.10) becomes

$$J_{\mathcal{V}}[f] = aa^T \cdot \left(\int_{\mathbb{R}^d} \varphi_0(x) dx \right)^2.$$

It will turn out later (cf. Lemma 10.1 and Theorem 2.3), that we need to choose $\varphi_0 : B_1^d \rightarrow \mathbb{R}$, such that $\alpha/C_{\mathcal{V}}^2$ is as large as possible, where $\alpha = \sigma_1(J_{\mathcal{V}}[f])$ stands for the spectral norm of $J_{\mathcal{V}}[f]$. Finally, if $p(x) = \frac{1}{\omega_d}$ for every $x \in B_1^d$ with ω_d denoting the Lebesgue volume of B_1^d and φ_0 is radial with $\varphi_0(1) = 0$, we get

$$\begin{aligned} \frac{\alpha}{C_{\mathcal{V}}^2} &= \frac{\left(\int_{\mathbb{R}^d} \varphi_0(x) dx \right)^2}{\omega_d^2 \max_{x \in B_1^d} \|\nabla \varphi_0(x)\|_2^2} = \frac{\left(\int_0^1 d\omega_d r^{d-1} \varphi_0(r) dr \right)^2}{\omega_d^2 \max_{0 < r < 1} |\varphi_0'(r)|^2} \leq d^2 \left(\int_0^1 \int_r^1 ds r^{d-1} dr \right)^2 \\ &= d^2 \left(\int_0^1 (1-r)r^{d-1} dr \right)^2 = d^2 \left(\frac{1}{d} - \frac{1}{d+1} \right)^2 = \frac{1}{(d+1)^2}. \end{aligned}$$

We observe that the conditions on $\{\varphi_\nu : \nu \in \mathcal{V}\}$ and $J_{\mathcal{V}}[f]$ may include an implicit dependence on d . This is in accordance with the very well-known fact, that even the identification of one neuron (or one ridge function) can suffer the curse of dimension if we do not pose any additional restrictions on its activation function or its weights, cf. [4, 22, 44].

(ii) In fact, one may relate (\mathcal{V}, π) and $\{\varphi_\nu : \nu \in \mathcal{V}\}$ directly to the density p as follows. We first consider a bounded resolution of the identity, i.e., a set of nonnegative smooth and compactly supported functions $\psi_\nu \geq 0$ such that $\int_{\mathcal{V}} \psi_\nu(x) d\pi(\nu) \equiv 1$ for all $x \in B_1^d$

and $\max_{\nu \in \mathcal{V}} \max_{x \in B_1^d} \{|\psi_\nu(x)|, \|\nabla \psi_\nu(x)\|_2\} \leq C_\Psi$. In case the set \mathcal{V} is discrete, then $\{\psi_\nu : \nu \in \mathcal{V}\}$ is simply a classical bounded partition of the unity. Additionally we pick yet another bounded and smooth function $q \geq 0$ such that $\max_{x \in B_1^d} \left\{ \frac{q(x)}{p(x)}, \left\| \frac{\nabla q(x)}{p(x)} \right\|_2 \right\} \leq C_q$.

Then, one can define

$$\varphi_\nu(x) = \psi_\nu(x)q(x),$$

and it is not difficult to show that conditions (2.9) are fulfilled. In fact, for densities p with bounded derivatives, e.g., Gaussian mixtures, one could choose for instance $q(x) = \frac{1}{2}p(x)^2$. In fact, in this case, $q(x)/p(x) = \frac{1}{2}p(x)$ and $\nabla q(x)/p(x) = \nabla p(x)$. Moreover, the matrix

$$J_{\mathcal{V}}[f] = \int_{\mathcal{V}} \left(\int_{\mathbb{R}^d} \nabla f(x) \psi_\nu(x) q(x) dx \right) \left(\int_{\mathbb{R}^d} \nabla f(x) \psi_\nu(x) q(x) dx \right)^T d\pi(\nu),$$

would correspond to the superposition of “weighted local evaluations” of $\nabla f \otimes \nabla f$ over the supports of the functions ψ_ν to build a full-rank matrix.

Now, differently from [33], we consider the following empirical vectors

$$\begin{aligned} Y_j &= -\frac{1}{N} \sum_{k=1}^N (f(x_k) + n_k) \frac{\nabla \varphi_{\nu_j}(x_k)}{p(x_k)} \approx -\int_{\mathbb{R}^d} f(x) \frac{\nabla \varphi_{\nu_j}(x)}{p(x)} p(x) dx \\ &= \int_{\mathbb{R}^d} \nabla f(x) \varphi_{\nu_j}(x) dx \\ &= \sum_{i=1}^m \left(\int_{\mathbb{R}^d} g'(\langle a_i, x \rangle) \varphi_{\nu_j}(x) dx \right) a_i, \end{aligned} \quad (2.11)$$

generated at random by sampling i.i.d. $\nu_j \sim \pi$, $j = 1, \dots, m_{\mathcal{X}}$. Here, the random variables n_k model the noise in the evaluation of the function f in the point x_k and we will assume that n_k are independent bounded centered random variables, i.e.,

$$|n_k| \leq C_{\mathcal{N}} \text{ with probability 1, and } \mathbb{E}[n_k] = 0. \quad (2.12)$$

The assumption that the noise is bounded can be relaxed to unbounded noise with thin tails (for instance sub-Gaussian noise) at the cost of adding in Theorem 2.3 below a negative term to the probability in the statement, which accounts for the probability that the noise realizations are in fact bounded. We define the matrix $Y_{\mathcal{V}} \in \mathbb{R}^{d \times m_{\mathcal{X}}}$, whose columns are Y_j , for $j = 1, \dots, m_{\mathcal{X}}$. We similarly denote $X_{\mathcal{V}} \in \mathbb{R}^{d \times m_{\mathcal{X}}}$ the matrix with columns $X_j = \int_{\mathbb{R}^d} \nabla f(x) \varphi_{\nu_j}(x) dx$. With similar arguments as Lemma 2.1 and Theorem 2.2 we can show the following result, whose proof is postponed to the Appendix.

Theorem 2.3. *Assume the vectors $(a_i)_{i=1}^m$ linearly independent, and $\|a_i\|_2 = 1$ for all $i = 1, \dots, m$. Additionally assume that*

$$C_\ell := \max_{i=1, \dots, m} \max_{-1 \leq t \leq 1} |g_i^{(\ell)}(t)| < \infty, \quad \ell = 0, 1.$$

Let \tilde{A} be constructed as described in Algorithm 2.1 by substituting there Y with $Y_{\mathcal{V}}$, built by sampling N values of f as in (2.11). Let $0 < s < 1$, and assume $\sigma_m(J_{\mathcal{V}}[f]) \geq \alpha > 0$. Then, for every $0 < \eta < \sqrt{\alpha(1-s)}$,

$$\|P_A - P_{\tilde{A}}\|_F \leq \frac{2\eta}{\sqrt{\alpha(1-s)} - \eta} \quad (2.13)$$

with probability at least $1 - \exp\left(-\frac{\eta^2 N}{8(2mQ)^2} + \frac{1}{4}\right) - m \exp\left(-\frac{m\chi\alpha s^2}{2(mQ)^2}\right)$, where $Q = (C_0 + C_N/m)C_V$. As a consequence, for any $\varepsilon > 0$ and $\delta > 0$,

$$\|P_A - P_{\tilde{A}}\|_F \leq \varepsilon \quad (2.14)$$

with probability at least $1 - \delta$ as soon as the number N of sampling values of f fulfills

$$N \geq \frac{32(2 + \varepsilon)^2(mQ)^2 \ln(3/\delta)}{\varepsilon^2\alpha(1 - s)}. \quad (2.15)$$

3 Dimensionality reduction

The main aim of this section is Theorem 3.1, which allows to reduce the general case of identification of a shallow network where the input dimension is larger than the number of neurons, $d \geq m$, to the case where $d = m$, hence, with a potentially significant dimensionality reduction. Due to the typical range of parameters we have in mind, this step is crucial in reducing the complexity of the approximation of (1.4).

Theorem 3.1 (Reduction to m dimensions). *Let us consider a function*

$$f(x) = \sum_{i=1}^m g_i(\langle a_i, x \rangle), \quad x \in B_1^d, \quad (3.1)$$

for $m \leq d$ and we denote $A = \text{span}\{a_1, \dots, a_m\}$. Let us now fix a m -dimensional subspace $\tilde{A} \subset \mathbb{R}^d$, for which we choose an orthonormal basis $\{\tilde{a}_1, \dots, \tilde{a}_m\}$, so that $\tilde{A} = \text{span}\{\tilde{a}_1, \dots, \tilde{a}_m\}$.³ We denote by P_A and $P_{\tilde{A}} = \tilde{A}\tilde{A}^T$ the orthogonal projections onto A and \tilde{A} , respectively. Then the function

$$\tilde{f}(y) = \sum_{i=1}^m g_i(\langle \alpha_i, y \rangle), \quad y \in B_1^m \subset \mathbb{R}^m, \quad (3.2)$$

with $\alpha_i = \tilde{A}^T a_i$ satisfies for any other function $\hat{f}: \mathbb{R}^m \rightarrow \mathbb{R}$ the following estimate

$$\|f - \hat{f}(\tilde{A}^T \cdot)\|_\infty \leq \|f\|_{\text{Lip}} \|P_A - P_{\tilde{A}}\| + \|\tilde{f} - \hat{f}\|_\infty. \quad (3.3)$$

Moreover, for any other set of vectors $\{\hat{\alpha}_1, \dots, \hat{\alpha}_m\} \subset \mathbb{R}^m$,

$$\|a_i - \tilde{A}\hat{\alpha}_i\|_2 \leq \|P_A - P_{\tilde{A}}\| + \|\alpha_i - \hat{\alpha}_i\|_2. \quad (3.4)$$

Proof. Let $x \in B_1^d$. We have

$$\begin{aligned} |f(x) - \hat{f}(\tilde{A}^T x)| &\leq |f(x) - \tilde{f}(\tilde{A}^T x)| + |\tilde{f}(\tilde{A}^T x) - \hat{f}(\tilde{A}^T x)| \\ &\leq |f(x) - f(\tilde{A}\tilde{A}^T x)| + \|\tilde{f} - \hat{f}\|_\infty = |f(P_A x) - f(P_{\tilde{A}} x)| + \|\tilde{f} - \hat{f}\|_\infty \\ &\leq \|f\|_{\text{Lip}} \cdot \|P_A x - P_{\tilde{A}} x\|_2 + \|\tilde{f} - \hat{f}\|_\infty. \end{aligned}$$

If we take the supremum over $x \in B_1^d$, we get (3.3).

The proof of (3.4) follows from

$$\begin{aligned} \|a_i - \tilde{A}\hat{\alpha}_i\|_2 &\leq \|a_i - \tilde{A}\alpha_i\|_2 + \|\tilde{A}(\alpha_i - \hat{\alpha}_i)\|_2 = \|(P_A - P_{\tilde{A}})a_i\|_2 + \|\tilde{A}(\alpha_i - \hat{\alpha}_i)\|_2 \\ &\leq \|P_A - P_{\tilde{A}}\| + \|\alpha_i - \hat{\alpha}_i\|_2. \quad \square \end{aligned}$$

³With a certain abuse of notation, we often use in this paper the symbol A also to denote the matrix whose columns are the vectors $\{a_1, \dots, a_m\}$. Similarly, we arrange the vectors \tilde{a}_i 's as columns of matrix \tilde{A} .

In view of Theorem 3.1, we start the identification of a sum of m ridge functions (3.1) on \mathbb{R}^d by first approximating the subspace $A = \text{span}\{a_1, \dots, a_m\}$ by another subspace \tilde{A} , such that the operator norm $\|P_A - P_{\tilde{A}}\|$ is small. Then we consider the function $\tilde{f}(y) = f(\tilde{A}y)$, which is a sum of m ridge functions on \mathbb{R}^m with ridge profiles $\alpha_1, \dots, \alpha_m$. Naturally, we will not be able to recover them exactly and we will only obtain some good approximation $\{\hat{\alpha}_1, \dots, \hat{\alpha}_m\} \subset \mathbb{R}^m$. Then (3.4) shows that the vectors $\tilde{A}\hat{\alpha}_i$ approximate well the original ridge profiles a_i . Finally, if \hat{f} is a uniform approximation of \tilde{f} on B_1^m , then (3.3) implies that the function $\hat{f}(\tilde{A}^T x)$ is a uniform approximation of f on B_1^d .

Observe that the sampling of \tilde{f} can be easily transferred to sampling of f by $\tilde{f}(y) = f(\tilde{A}y)$.

4 Principal Hessian subspace

While first order differentiation provides information about the active subspace $A = \text{span}\{a_1, \dots, a_m\}$, we need to query higher order derivatives in order to access the individual weights a_1, \dots, a_m . First of all we construct here an approximation $\tilde{\mathcal{A}}$ to the space $\mathcal{A} = \text{span}\{a_i \otimes a_i, i = 1, \dots, m\}$. As in the previous sections we describe two different methods of identification of \mathcal{A} . The first one is by active sampling and makes use of second order differences. The second one implements passive sampling under the assumption that we dispose of the probability density $p(x)$ of the point distribution.

4.1 Active sampling

We start by generating again $m_{\mathcal{X}} \in \mathbb{N}$ points $x_l \sim \mu_{\mathbb{S}^{m-1}}$, $l = 1, \dots, m_{\mathcal{X}}$ uniformly at random on the $m - 1$ dimensional sphere (remind that now we assume $m = d$), and we define

$$(\Delta[f](x_l))_{j,k} = \frac{f(x_l + \epsilon(e_j + e_k)) - f(x_l + \epsilon e_j) - f(x_l + \epsilon e_k) + f(x_l)}{\epsilon^2}, \quad j, k = 1, \dots, m.$$

As $\Delta[f](x) \sim \nabla^2 f(x) = \sum_{i=1}^m g_i''(\langle a_i, x \rangle) a_i \otimes a_i \in \mathcal{A}$, we define $\tilde{\mathcal{A}}$ as the m -dimensional subspace approximating the points $(\Delta[f](x_l))_{l=1}^{m_{\mathcal{X}}}$ in the least-square sense. For later use we define Y the $m^2 \times m_{\mathcal{X}}$ matrix with columns $\text{vec}(\Delta[f](x_l))$, i.e.,

$$Y = (\text{vec}(\Delta[f](x_1)) | \dots | \text{vec}(\Delta[f](x_{m_{\mathcal{X}}}))). \quad (4.1)$$

We show below that $\tilde{\mathcal{A}}$ is indeed a good approximation to \mathcal{A} by showing that the difference of the respective orthogonal projections $\|P_{\mathcal{A}} - P_{\tilde{\mathcal{A}}}\|_{F \rightarrow F}$ in the operator norm associated to the Frobenius norm of matrices is small with high probability, as soon as $m_{\mathcal{X}}$ is large enough.

We need now to introduce some notations to facilitate the presentation. We define the vectorization of a matrix $A = (a_{i,j})_{i,j} \in \mathbb{R}^{m \times m}$ as the column vector in \mathbb{R}^{m^2}

$$\text{vec}(A)_k := a_{\lfloor \frac{k-1}{m} \rfloor + 1, (k-1 \bmod m) + 1}, \quad k = 1, \dots, m^2. \quad (4.2)$$

For two matrices $A, B \in \mathbb{R}^{m \times m}$ we define their *vectorized tensor product* by

$$A \otimes_v B := \text{vec}(A) \otimes \text{vec}(B) = \text{vec}(A) \text{vec}(B)^T. \quad (4.3)$$

(Note that such a product of matrices does coincide neither with the Hadamard product nor with the Kronecker product.) Thanks to these definitions and notations we can introduce the matrix

$$H_2[f] := \int_{\mathbb{S}^{m-1}} \nabla^2 f(x) \otimes_v \nabla^2 f(x) d\mu_{\mathbb{S}^{m-1}}(x).$$

This $m^2 \times m^2$ matrix plays exactly the same role as $J[f]$ in Section 2.1.

Algorithm 4.1.

- Construct Y as in (4.1).
- Compute the singular value decomposition of

$$Y^T = \begin{pmatrix} \tilde{U}_1 & \tilde{U}_2 \end{pmatrix} \begin{pmatrix} \tilde{\Sigma}_1 & 0 \\ 0 & \tilde{\Sigma}_2 \end{pmatrix} \begin{pmatrix} \tilde{V}_1^T \\ \tilde{V}_2^T \end{pmatrix},$$

where $\tilde{\Sigma}_1$ contains the m largest singular values.

- Set \tilde{A} to be the space of matrices, whose vectorization lies in the row space of \tilde{V}_1^T .

As we follow the same strategy as the one used in Section 2.1 to approximate the space $A = \text{span}\{a_i, i = 1, \dots, m\}$, we limit ourselves to reformulate it in the context of the vector space of matrices \mathcal{A} . We start with a technical estimate, which is essentially based on Taylor's theorem.

Lemma 4.1. *Assume the vectors $(a_i)_{i=1}^m$ satisfy $\|a_i\|_2 = 1$ for all $i = 1, \dots, m$ and assume that $g_j, j = 1, \dots, m$, are two times differentiable with the Lipschitz constant of all $g_j'', j = 1, \dots, m$ bounded from above by $C_3 > 0$. Then, for all $x \in \mathbb{S}^{m-1}$,*

$$\|\nabla^2 f(x) - \Delta[f](x)\|_F \leq 2C_3 m \epsilon.$$

Proof. Let $g(t) = f(x + te_j + \epsilon e_k) - f(x + te_j)$, where $0 \leq t \leq \epsilon$. Then by the mean value theorem

$$\begin{aligned} (\Delta[f](x))_{j,k} &= \frac{g(\epsilon) - g(0)}{\epsilon^2} = \frac{g'(\xi_1)}{\epsilon} = \frac{\frac{\partial f}{\partial x_j}(x + \xi_1 e_j + \epsilon e_k) - \frac{\partial f}{\partial x_j}(x + \xi_1 e_j)}{\epsilon} \\ &= \frac{\partial^2 f}{\partial x_k \partial x_j}(x + \xi_1 e_j + \xi_2 e_k), \end{aligned}$$

where $0 < \xi_1, \xi_2 < \epsilon$. Therefore

$$\begin{aligned} |(\nabla^2 f(x))_{j,k} - (\Delta[f](x))_{j,k}| &= \left| \frac{\partial^2 f}{\partial x_k \partial x_j}(x) - \frac{\partial^2 f}{\partial x_k \partial x_j}(x + \xi_1 e_j + \xi_2 e_k) \right| \\ &\leq \sum_{l=1}^m |g_l''(\langle a_l, x \rangle) - g_l''(\langle a_l, x + \xi_1 e_j + \xi_2 e_k \rangle)| \cdot |a_{l,j}| \cdot |a_{l,k}| \\ &\leq C_3 \epsilon \sum_{l=1}^m |a_{l,j}| \cdot |a_{l,k}| \cdot (|a_{l,j}| + |a_{l,k}|). \end{aligned}$$

Using triangle inequality and $\|a_j\|_4 \leq \|a_j\|_2 = 1$, we estimate

$$\begin{aligned} \|\nabla^2 f(x) - \Delta[f](x)\|_F &\leq 2C_3\epsilon \left[\sum_{j,k=1}^m \left(\sum_{i=1}^m a_{i,j}^2 |a_{i,k}| \right)^2 \right]^{1/2} \leq 2C_3\epsilon \sum_{i=1}^m \left(\sum_{j,k=1}^m a_{i,j}^4 a_{i,k}^2 \right)^{1/2} \\ &= 2C_3\epsilon \sum_{i=1}^m \left[\left(\sum_{j=1}^m a_{i,j}^4 \right) \left(\sum_{k=1}^m a_{i,k}^2 \right) \right]^{1/2} \leq 2C_3\epsilon m. \end{aligned}$$

□

Theorem 4.2. *Assume the vectors $(a_i)_{i=1}^m$ linearly independent, and $\|a_i\|_2 = 1$ for all $i = 1, \dots, m$. Additionally assume*

$$C_j := \max_{i=1, \dots, m} \max_{-1 \leq t \leq 1} |g_i^{(j)}(t)| < \infty, \quad j = 0, 1, 2.$$

Let $\tilde{\mathcal{A}}$ be constructed as described in Algorithm 4.1 by sampling $m_{\mathcal{X}} [(m+1)(m+2)/2]$ values of f . Let $0 < s < 1$, and assume $\sigma_m(H_2[f]) \geq \alpha_2 > 0$, i.e., the m^{th} singular value of the matrix $H_2[f]$ is bounded away from zero. Then

$$\|P_{\mathcal{A}} - P_{\tilde{\mathcal{A}}}\|_{F \rightarrow F} \leq \frac{4C_3m\epsilon}{\sqrt{\alpha_2(1-s)} - 2C_3m\epsilon}$$

with probability at least $1 - m \exp\left(-\frac{m_{\mathcal{X}}\alpha_2 s^2}{2m^2 C_2^2}\right)$. In particular $\dim(\mathcal{A}) = \dim(\tilde{\mathcal{A}}) = m$.

Proof. We define the matrices X, Y whose columns are given by $\text{vec}(\nabla^2 f(x_j))$, $j = 1, \dots, m_{\mathcal{X}}$ and $\text{vec}(\Delta[f](x_j))$, $j = 1, \dots, m_{\mathcal{X}}$ respectively, namely

$$X = (\text{vec}(\nabla^2 f(x_1)) | \dots | \text{vec}(\nabla^2 f(x_{m_{\mathcal{X}})})), \quad Y = (\text{vec}(\Delta[f](x_1)) | \dots | \text{vec}(\Delta[f](x_{m_{\mathcal{X}})})).$$

Notice that these matrices have dimension $m^2 \times m_{\mathcal{X}}$. As done in (2.7) and by assuming for the moment that $\sigma_m(X) \neq 0$ (but obviously $\sigma_{m+1}(X) = 0$ because the $\nabla^2 f(x_i)$'s lie all in the m -dimensional space \mathcal{A}), we deduce the estimate

$$\|P_{\mathcal{A}} - P_{\tilde{\mathcal{A}}}\|_{F \rightarrow F} \leq \frac{2\|X - Y\|_F}{\sigma_m(X) - \|X - Y\|_F}, \quad (4.4)$$

as an application of Wedin's bound, Theorem 10.2 in the Appendix. From Lemma 4.1 we easily deduce

$$\|X - Y\|_F = \left(\sum_{j=1}^{m_{\mathcal{X}}} \|\nabla^2 f(x_j) - \Delta[f](x_j)\|_F^2 \right)^{1/2} \leq 2C_3\epsilon m \sqrt{m_{\mathcal{X}}}. \quad (4.5)$$

In order to apply (4.4) we need finally to estimate $\sigma_m(X)$ from below and we shall do it by using again the Chernoff's bound for matrices Theorem 10.3.

Given an orthonormal basis $\{B_1, \dots, B_m\}$ for \mathcal{A} we define the projector from $\mathbb{R}^{m^2} \rightarrow \mathbb{R}^m$ given by $P^{\mathcal{A}}v = (\text{vec}(B_1)^T v, \dots, \text{vec}(B_m)^T v)$ for any $v \in \mathbb{R}^{m^2}$. We additionally define with some abuse of notation

$$P^{\mathcal{A}}X := (P^{\mathcal{A}}(\text{vec}(\nabla^2 f(x_1))) | \dots | P^{\mathcal{A}}(\text{vec}(\nabla^2 f(x_{m_{\mathcal{X}})}))).$$

Notice that now this matrix has dimension $m \times m_{\mathcal{X}}$. Thanks to the fact that $P^{\mathcal{A}}$ is an orthogonal transformation, we obtain the following equivalences

$$\sigma_m(X) = \sqrt{\sigma_m((P^{\mathcal{A}}X)(P^{\mathcal{A}}X)^T)}.$$

Hence to estimate $\sigma_m(X)$, it is sufficient to do it for $\sigma_m((P^{\mathcal{A}}X)(P^{\mathcal{A}}X)^T)$, whose argument is explicitly expressed as a sum

$$(P^{\mathcal{A}}X)(P^{\mathcal{A}}X)^T = \sum_{j=1}^{m_{\mathcal{X}}} X_j,$$

where

$$X_j = P^{\mathcal{A}} \text{vec}(\nabla^2 f(x_j)) \otimes \text{vec}(\nabla^2 f(x_j))(P^{\mathcal{A}})^T.$$

We wish to apply Theorem 10.3 for the sequence of positive semidefinite matrices $X_1, \dots, X_{m_{\mathcal{X}}}$. We notice first that

$$\mathbb{E}X_j = P^{\mathcal{A}} H_2^f (P^{\mathcal{A}})^T,$$

and therefore

$$\mu_{\min}(\mathbb{E}X_j) \geq m_{\mathcal{X}} \alpha_2. \quad (4.6)$$

Additionally, for every $x \in \mathbb{S}^{m-1}$

$$\begin{aligned} \sigma_1(P^{\mathcal{A}} \text{vec}(\nabla^2 f(x)) \otimes \text{vec}(\nabla^2 f(x))(P^{\mathcal{A}})^T) &= \sigma_1(\text{vec}(\nabla^2 f(x)) \otimes \text{vec}(\nabla^2 f(x))) \\ &\leq \|\nabla^2 f(x)\|_F^2 \\ &= \left\| \sum_{i=1}^m g''(\langle a_i, x \rangle) a_i \otimes a_i \right\|_F^2 \\ &\leq C_2^2 m^2. \end{aligned} \quad (4.7)$$

An application of Theorem 10.3 under conditions (4.6) and (4.7) yields

$$\sigma_m(X) \geq \sqrt{m_{\mathcal{X}} \alpha_2 (1-s)}, \quad (4.8)$$

with probability

$$1 - m \exp\left(-\frac{m_{\mathcal{X}} \alpha_2 s^2}{2m^2 C_2^2}\right).$$

We conclude from (4.5) and (4.8) that, with the same probability,

$$\|P_{\mathcal{A}} - P_{\tilde{\mathcal{A}}}\|_{F \rightarrow F} \leq \frac{4C_3 m \epsilon}{\sqrt{\alpha_2 (1-s)} - 2C_3 m \epsilon}. \quad \square$$

4.2 Passive sampling

We again assume that we are given a probability space (\mathcal{V}, π) and a suitable collection of \mathcal{C}_c^2 functions $\varphi_{\nu} : \mathbb{R}^d \rightarrow \mathbb{R}$, for $\nu \in \mathcal{V}$, with the properties

$$\text{supp } \varphi_{\nu} \subset B_1^d \text{ for all } \nu \in \mathcal{V}, \quad \max_{\nu \in \mathcal{V}} \max \left\{ \int_{\mathbb{R}^d} |\varphi_{\nu}(x)| dx, \max_{x \in B_1^d} \left\| \frac{\nabla^2 \varphi_{\nu}(x)}{p(x)} \right\|_F \right\} \leq C_{\mathcal{V}, 2},$$

where in the latter bound we consider the Frobenius norm. Furthermore, we also assume that the matrix

$$H_{\mathcal{V}}[f] = \int_{\mathcal{V}} \left(\int_{\mathbb{R}^d} \nabla^2 f(x) \varphi_{\nu}(x) dx \right) \otimes_{\nu} \left(\int_{\mathbb{R}^d} \nabla^2 f(x) \varphi_{\nu}(x) dx \right)^T d\pi(\nu)$$

has full rank. We consider the following empirical vectors

$$\begin{aligned} Y_j &= \text{vec} \left(\frac{1}{N} \sum_{k=1}^N (f(x_k) + n_k) \frac{\nabla^2 \varphi_{\nu_j}(x_k)}{p(x_k)} \right) \approx \text{vec} \left(\int_{\mathbb{R}^d} f(x) \frac{\nabla^2 \varphi_{\nu_j}(x)}{p(x)} p(x) dx \right) \\ &= \text{vec} \left(\int_{\mathbb{R}^d} \nabla^2 f(x) \varphi_{\nu_j}(x) dx \right) \\ &= \sum_{i=1}^m \text{vec} \left(\left(\int_{\mathbb{R}^d} g''(\langle a_i, x \rangle) \varphi_{\nu_j}(x) dx \right) a_i \otimes a_i \right), \end{aligned} \quad (4.9)$$

generated at random by sampling i.i.d. $\nu_j \sim \pi$, $j = 1, \dots, m_{\mathcal{X}}$, for n_k independent random bounded and centered noise fulfilling (2.12). We define the matrix $Y_{\mathcal{V},2} \in \mathbb{R}^{m^2 \times m_{\mathcal{X}}}$, whose columns are Y_j , for $j = 1, \dots, m_{\mathcal{X}}$. We similarly denote $X_{\mathcal{V},2} \in \mathbb{R}^{m^2 \times m_{\mathcal{X}}}$ the matrix with columns $X_j = \text{vec} \left(\int_{\mathbb{R}^d} \nabla^2 f(x) \varphi_{\nu_j}(x) dx \right)$.

The proof of the following result resembles the proofs of Theorem 4.2 and Theorem 2.3 and is postponed to the Appendix.

Theorem 4.3. *Assume the vectors $(a_i)_{i=1}^m$ linearly independent, and $\|a_i\|_2 = 1$ for all $i = 1, \dots, m$. Additionally assume*

$$C_j := \max_{i=1, \dots, m} \max_{-1 \leq t \leq 1} |g_i^{(j)}(t)| < \infty, \quad j = 0, 1, 2.$$

Let $\tilde{\mathcal{A}}$ be constructed as described in Algorithm 4.1 by substituting there Y with $Y_{\mathcal{V},2}$, built by sampling N values of f as in (4.9). Let $0 < s < 1$, and assume $\sigma_m(H_{\mathcal{V}}[f]) \geq \alpha_2 > 0$. Then, for $0 < \eta < \sqrt{\alpha_2(1-s)}$,

$$\|P_{\mathcal{A}} - P_{\tilde{\mathcal{A}}}\|_{F \rightarrow F} \leq \frac{2\eta}{\sqrt{\alpha_2(1-s)} - \eta} \quad (4.10)$$

with probability at least $1 - \exp\left(-\frac{\eta^2 N}{8(2mQ)^2} + \frac{1}{4}\right) - m \exp\left(-\frac{m_{\mathcal{X}} \alpha_2 s^2}{2(mQ)^2}\right)$, for $Q = (\max\{C_0, C_2\} + C_{\mathcal{N}}/m)C_{\mathcal{V},2}$. As a consequence, for any $\varepsilon > 0$ and $\delta > 0$,

$$\|P_{\mathcal{A}} - P_{\tilde{\mathcal{A}}}\|_{F \rightarrow F} \leq \varepsilon, \quad (4.11)$$

with probability at least $1 - \delta$ as soon as the number N of sampling values of f fulfills

$$N \geq \frac{32(2 + \varepsilon)^2 (mQ)^2 \ln(3/\delta)}{\varepsilon^2 \alpha_2 (1-s)}. \quad (4.12)$$

5 Near orthonormality

As we shall see in Section 6 and as pointed already in the Introduction, the problem of the identification of near rank-1 matrices in $\tilde{\mathcal{A}} \approx \mathcal{A} = \text{span}\{a_i \otimes a_i, i = 1, \dots, m\} \subset \mathbb{R}^{m \times m}$ is greatly simplified if one can assume that $\{a_1, \dots, a_m\}$ are nearly orthonormal vectors. In this section, we introduce the concept of near-orthonormality and its basic properties.

Definition 5.1. We define

$$\mathcal{S}(\alpha_1, \dots, \alpha_m) = \inf \left\{ \left(\sum_{i=1}^m \|\alpha_i - w_i\|_2^2 \right)^{1/2} : w_1, \dots, w_m \text{ orthonormal basis in } \mathbb{R}^m \right\} \quad (5.1)$$

for every set $\{\alpha_1, \dots, \alpha_m\} \subset \mathbb{R}^m$. We say that unit vectors $a_1, \dots, a_m \in \mathbb{R}^m$ are ε -nearly-orthonormal, if $\mathcal{S}(a_1, \dots, a_m) \leq \varepsilon$ for $\varepsilon > 0$ relatively small.

Theorem 5.1. (i) Let $a_1, \dots, a_m \in \mathbb{R}^m$ and let $A \in \mathbb{R}^{m \times m}$ be a matrix with columns a_1, \dots, a_m . Then

$$\mathcal{S}(a_1, \dots, a_m) = \left(\sum_{i=1}^m (\sigma_i - 1)^2 \right)^{1/2},$$

where $\sigma_1 \geq \sigma_2 \geq \dots \geq 0$ are the singular values of A .

(ii) Furthermore,

$$\mathcal{S}(a_1, \dots, a_m) \leq \|AA^T - I_m\|_F \leq (\|A\| + 1)\mathcal{S}(a_1, \dots, a_m).$$

Proof. (i) The result is very well known and the proof follows easily by singular value decomposition of $A = U\Sigma V^T$. The closest orthogonal basis w_1, \dots, w_m is given as the columns of the matrix $W = UV^T$.

(ii) First observe that if $A = U\Sigma V^T$, then

$$\|AA^T - I_m\|_F = \|U\Sigma^2 U^T - I_m\|_F = \left(\sum_{i=1}^m [\sigma_i^2 - 1]^2 \right)^{1/2}.$$

Hence

$$\begin{aligned} \mathcal{S}(a_1, \dots, a_m) &= \left(\sum_{i=1}^m (\sigma_i - 1)^2 \right)^{1/2} \leq \left(\sum_{i=1}^m (\sigma_i - 1)^2 (\sigma_i + 1)^2 \right)^{1/2} \\ &= \left(\sum_{i=1}^m (\sigma_i^2 - 1)^2 \right)^{1/2} = \|AA^T - I_m\|_F \\ &\leq \max_i (\sigma_i + 1) \left(\sum_{i=1}^m [\sigma_i - 1]^2 \right)^{1/2} = (\|A\| + 1)\mathcal{S}(a_1, \dots, a_m). \end{aligned}$$

□

Lemma 5.2. Let $\varepsilon > 0$ and let $a_1, \dots, a_m \in \mathbb{R}^m$ with $\mathcal{S}(a_1, \dots, a_m) \leq \varepsilon$ and $\|a_i\|_2 = 1$ for all $i = 1, \dots, m$ and let $A \in \mathbb{R}^{m \times m}$ be a matrix with columns a_1, \dots, a_m .

(i) Then

$$(1 - \varepsilon)\|y\|_2 \leq \|Ay\|_2 \leq (1 + \varepsilon)\|y\|_2$$

for all $y \in \mathbb{R}^m$. The result holds with identical proof also for A^T instead of A substituted in the inequality.

(ii) Let $M = \sum_{j=1}^m \sigma_j a_j \otimes a_j$, then $\|M\| \leq (1 + \varepsilon)^2 \|\sigma\|_\infty$.

(iii) $\sum_{k \neq j} \langle a_k, a_j \rangle^2 \leq 2\varepsilon^2$ for all $j = 1, \dots, m$.

(iv) $\mathcal{S}(a_1 \otimes a_1, \dots, a_m \otimes a_m) \leq 2\varepsilon$.

(v) $(1 - 2\varepsilon)\|\sigma\|_2 \leq \left\| \sum_{j=1}^m \sigma_j a_j \otimes a_j \right\|_F \leq (1 + 2\varepsilon)\|\sigma\|_2$.

(vi) Let $b_j, j = 1, \dots, m$ be the dual basis of $a_j, j = 1, \dots, m$ (i.e. $\langle b_i, a_j \rangle = \delta_{i,j}$). Then $\|b_j\|_2 \leq 1/(1 - \varepsilon)$ for all $j = 1, \dots, m$.

Proof. We denote by W be the optimal orthonormal matrix for A and its columns by w_1, \dots, w_m .

(i) Then

$$\|Ay\|_2 = \|(A - W)y + Wy\|_2 \leq \|A - W\| \cdot \|y\|_2 + \|Wy\|_2 \leq (1 + \varepsilon)\|y\|_2.$$

The estimate from below follows by applying the inverse triangle inequality. The proof can be used similarly also for obtaining the bounds for A^T instead of A .

(ii) We estimate by (i)

$$\|M\| = \|A\Sigma A^T\| \leq \|A\| \cdot \|\Sigma\| \cdot \|A^T\| \leq (1 + \varepsilon)^2 \|\sigma\|_\infty,$$

where $\Sigma \in \mathbb{R}^{m \times m}$ is a diagonal matrix with $(\sigma_1, \dots, \sigma_m)$ on its main diagonal.

(iii) Fix $j \in \{1, \dots, m\}$ and let $\bar{A} \in \mathbb{R}^{m \times (m-1)}$ be A without the j -th column. Similarly, we define \bar{W} . Then we obtain

$$\begin{aligned} \left(\sum_{k \neq j} \langle a_k, a_j \rangle^2 \right)^{1/2} &= \|\bar{A}^T a_j\|_2 \leq \|(\bar{A} - \bar{W})^T a_j\|_2 + \|\bar{W}^T a_j\|_2 \\ &\leq \|\bar{A} - \bar{W}\| + \|\bar{W}^T (a_j - w_j)\|_2 \leq \|\bar{A} - \bar{W}\|_F + \|a_j - w_j\|_2 \\ &\leq \sqrt{2}\|A - W\|_F. \end{aligned}$$

(iv) We use triangle inequality and obtain

$$\|a_j \otimes a_j - w_j \otimes w_j\|_F \leq \|(a_j - w_j) \otimes a_j\|_F + \|w_j \otimes (a_j - w_j)\|_F \leq 2\|a_j - w_j\|_2.$$

Summing this estimate squared over $j = 1, \dots, m$, we obtain the result.

(v) Using (iv) and Cauchy-Schwarz inequality, we estimate

$$\begin{aligned} \|A\Sigma A^T\|_F &\leq \|W\Sigma W^T\|_F + \|A\Sigma A^T - W\Sigma W^T\|_F \\ &\leq \|\sigma\|_2 + \sum_{j=1}^m |\sigma_j| \cdot \|a_j \otimes a_j - w_j \otimes w_j\|_F \\ &\leq \|\sigma\|_2 + \left(\sum_{j=1}^m \sigma_j^2 \right)^{1/2} \cdot \left(\sum_{j=1}^m \|a_j \otimes a_j - w_j \otimes w_j\|_F^2 \right)^{1/2} \\ &\leq (1 + 2\varepsilon)\|\sigma\|_2 \end{aligned}$$

and similarly for the other side.

(vi) The result follows from

$$\begin{aligned}\|b_j\|_2 &= \|W^T b_j\|_2 = \|A^T b_j + (W^T - A^T)b_j\|_2 \leq \|A^T b_j\|_2 + \|(W^T - A^T)b_j\|_2 \\ &\leq 1 + \|W^T - A^T\| \cdot \|b_j\|_2 \leq 1 + \varepsilon \|b_j\|_2.\end{aligned}\quad \square$$

The next lemma shows that normalization of a set of vectors does not influence much their distance to an orthonormal basis.

Lemma 5.3. *Let $\{\alpha_1, \dots, \alpha_m\} \subset \mathbb{R}^m$ be arbitrary non-zero vectors in \mathbb{R}^m . Then*

$$\mathcal{S}\left(\frac{\alpha_1}{\|\alpha_1\|_2}, \dots, \frac{\alpha_m}{\|\alpha_m\|_2}\right) \leq \sqrt{2}\mathcal{S}(\alpha_1, \dots, \alpha_m).$$

Proof. Let $\{w_1, \dots, w_m\} \subset \mathbb{R}^m$ be the closest orthonormal basis to $\alpha_1, \dots, \alpha_m$. Then we may assume that $\langle \alpha_i, w_i \rangle \geq 0$, otherwise exchanging w_i for $-w_i$ would decrease the distance to $\{\alpha_1, \dots, \alpha_m\}$.

For every $i = 1, \dots, m$, we obtain

$$\|\alpha_i - w_i\|_2^2 \geq \left\| \left\langle w_i, \frac{\alpha_i}{\|\alpha_i\|_2} \right\rangle \frac{\alpha_i}{\|\alpha_i\|_2} - w_i \right\|_2^2 = 1 - \left\langle w_i, \frac{\alpha_i}{\|\alpha_i\|_2} \right\rangle^2$$

and therefore

$$\left\| \frac{\alpha_i}{\|\alpha_i\|_2} - w_i \right\|_2^2 = 2 \left(1 - \frac{\langle \alpha_i, w_i \rangle}{\|\alpha_i\|_2} \right) \leq 2 \left(1 - \frac{\langle \alpha_i, w_i \rangle^2}{\|\alpha_i\|_2^2} \right) \leq 2 \|\alpha_i - w_i\|_2^2.$$

To finish the proof, we sum up over $i = 1, \dots, m$ and take the square root. \square

Lemma 5.4. *Let $\{\alpha_1, \dots, \alpha_m\} \subset \mathbb{R}^n$ be arbitrary linearly independent vectors with unit Euclidean norm and let $\{\omega_1, \dots, \omega_m\} \subset \mathbb{R}^n$ be orthonormal. Let $\mathcal{A} = \text{span}\{\alpha_1, \dots, \alpha_m\}$, $\hat{\mathcal{A}} = \text{span}\{\omega_1, \dots, \omega_m\}$, and*

$$\left(\sum_{i=1}^m \|\alpha_i - \omega_i\|_2^2 \right)^{1/2} \leq \varepsilon < 1.$$

Then

$$\|P_{\mathcal{A}} - P_{\hat{\mathcal{A}}}\| \leq 4\varepsilon,$$

where $P_{\mathcal{A}}$ and $P_{\hat{\mathcal{A}}}$ are the orthogonal projections on \mathcal{A} and $\hat{\mathcal{A}}$ respectively.

Proof. Let $A \in \mathbb{R}^{n \times m}$ have columns $\alpha_1, \dots, \alpha_m$ and let $W \in \mathbb{R}^{n \times m}$ have columns $\omega_1, \dots, \omega_m$. Then $P_{\hat{\mathcal{A}}} = WW^T$. If $A = U\Sigma V^T$ is the singular value decomposition of A with $U \in \mathbb{R}^{n \times m}$, $\Sigma \in \mathbb{R}^{m \times m}$ and $V \in \mathbb{R}^{m \times m}$, then $P_{\mathcal{A}} = UU^T$. Further we denote by $B = UV^T$ the closest matrix to A in Frobenius norm with orthonormal columns, see also Theorem 5.1. Hence, $\|A - B\|_F \leq \|A - W\|_F \leq \varepsilon$, $\|B - W\|_F \leq 2\varepsilon$ and

$$\begin{aligned}\|P_{\mathcal{A}} - P_{\hat{\mathcal{A}}}\| &= \|UU^T - WW^T\| \leq \|UV^T VU^T - WW^T\|_F = \|BB^T - WW^T\|_F \\ &\leq \|B(B^T - W^T)\|_F + \|(B - W)W^T\|_F \leq 2\varepsilon + 2\varepsilon = 4\varepsilon.\end{aligned}\quad \square$$

We conclude this subsection with a remark related to the stability of the result of Theorem 3.1 with respect to ε -nearly orthonormality.

Remark 5. Let $\{a_1, \dots, a_m\}$ be ε -nearly orthonormal and let $\{w_1, \dots, w_m\} \subset \mathbb{R}^d$ be an optimal approximating orthonormal basis such that

$$\mathcal{S}(a_1, \dots, a_m) = \left(\sum_{j=1}^m \|a_j - w_j\|_2^2 \right)^{1/2} = \varepsilon.$$

By Theorem 5.1 (and its proof) we can assume that $\{w_1, \dots, w_m\} \subset A$. Then for the vectors $\alpha_i = \tilde{A}^T a_i, i = 1, \dots, m$ constructed in Theorem 3.1 it holds

$$\begin{aligned} \mathcal{S}(\alpha_1, \dots, \alpha_m) &= \mathcal{S}(\tilde{A}^T a_1, \dots, \tilde{A}^T a_m) = \mathcal{S}(\tilde{A}\tilde{A}^T a_1, \dots, \tilde{A}\tilde{A}^T a_m) \\ &= \mathcal{S}(P_{\tilde{A}} a_1, \dots, P_{\tilde{A}} a_m) \leq \left(\sum_{j=1}^m \|P_{\tilde{A}} a_j - w_j\|_2^2 \right)^{1/2} \\ &\leq \left(\sum_{j=1}^m \|P_{\tilde{A}} a_j - P_{\tilde{A}} w_j\|_2^2 \right)^{1/2} + \left(\sum_{j=1}^m \|P_{\tilde{A}} w_j - P_A w_j\|_2^2 \right)^{1/2} \\ &\leq \varepsilon + \|P_{\tilde{A}} - P_A\|_F. \end{aligned}$$

Hence, if the vectors a_1, \dots, a_m are orthogonal, or nearly-orthonormal in the sense of Definition 5.1, the vectors $\alpha_1, \dots, \alpha_m$ behave similarly.

6 Identification of weights

In the case of nearly orthonormal weights $\{a_i : i = 1, \dots, m\}$, the geometry of the space $\tilde{\mathcal{A}} \approx \mathcal{A} = \text{span}\{a_i \otimes a_i, i = 1, \dots, m\} \subset \mathbb{R}^{m \times m}$ can be described by the Euclidean representation of Figure 1. Inspired by this geometrical description, for the identification of the individual weights, we consider the following nonlinear program

$$\arg \max \|M\|, \quad \text{s.t.} \quad M \in \tilde{\mathcal{A}}, \|M\|_F \leq 1 \quad (6.1)$$

to recover the a_i 's - or, more precisely, their approximations \hat{a}_i (which is of course possible only up to the sign).

The optimization problem (6.1) is not convex and may in general have a large number of local maxima. Nevertheless, we shall prove that to every local maximizer of (6.1), there is one of the matrices $a_i \otimes a_i$, which lies very close to it. Moreover, we show also the converse, i.e., that every $a_i \otimes a_i$ is well-approximated by a local maximizer of (6.1). In particular, for $\tilde{\mathcal{A}} = \mathcal{A}$ and the vectors $a_1, \dots, a_m \in \mathbb{R}^m$ orthonormal, we obtain the exact recovery of the $a_i \otimes a_i$'s.

6.1 Characterization of local maximizers

In this section we address the analysis of the optimization program (6.1), and we derive a characterization of its local maximal solutions. First of all let us observe that every local maximizer of (6.1) will be always found on the sphere $\mathbb{S}_{\tilde{\mathcal{A}}} = \{M \in \tilde{\mathcal{A}} : \|M\|_F = 1\}$. The set $\mathbb{S}_{\tilde{\mathcal{A}}}$ is a unit sphere in a Hilbert space of (symmetric) matrices, intersected with a linear subspace, and therefore everywhere differentiable. Despite the nonsmoothness of the objective function, i.e. $M \rightarrow \|M\|$, the solution of the nonconvex program (6.1) will be tackled by means of differential methods.

Theorem 6.1. *Let M be any local maximizer of*

$$\arg \max \|M\|, \quad \text{s.t.} \quad M \in \tilde{\mathcal{A}}, \quad \|M\|_F \leq 1. \quad (6.2)$$

Let us denote the eigenvalues of M by $\lambda_1, \lambda_2, \dots, \lambda_m$ and the corresponding eigenvectors by u_1, \dots, u_m . We assume that the eigenvalues are ordered by their absolute value, i.e., that $|\lambda_1| \geq |\lambda_2| \geq \dots \geq 0$. Then

$$\begin{aligned} u_j^T X u_j &= \lambda_j \langle X, M \rangle_F \quad \text{for every } X \in \tilde{\mathcal{A}} \\ \text{and all } j &\in \{1, \dots, m\} \quad \text{with } |\lambda_j| = \|M\|. \end{aligned} \quad (6.3)$$

If furthermore

$$\mathcal{S}(a_1, \dots, a_m) \leq \varepsilon \quad \text{and} \quad 3m \|P_{\mathcal{A}} - P_{\tilde{\mathcal{A}}}\|_{F \rightarrow F} < (1 - \varepsilon)^2, \quad (6.4)$$

then $|\lambda_1| = \|M\|$, $\lambda_1 \notin \{\lambda_2, \dots, \lambda_m\}$ and

$$2 \sum_{k=2}^m \frac{(u_1^T X u_k)^2}{|\lambda_1 - \lambda_k|} \leq \|M\| \cdot \|X - \langle X, M \rangle_F M\|_F^2 \quad \text{for all } X \in \tilde{\mathcal{A}}. \quad (6.5)$$

Remark 6. (i) In the proof we will only show that (6.3) holds for all X orthogonal to M , i.e., that

$$\begin{aligned} u_j^T X u_j &= 0 \quad \text{for all } X \in \mathbb{S}_{\tilde{\mathcal{A}}} \quad \text{with } X \perp M \\ \text{and all } j &\in \{1, \dots, m\} \quad \text{with } |\lambda_j| = \|M\|. \end{aligned} \quad (6.6)$$

If $X \in \tilde{\mathcal{A}}$ is not orthogonal to M and not co-linear with M , then (6.3) follows from (6.6) by considering the matrix

$$\frac{X - \langle X, M \rangle_F M}{\|X - \langle X, M \rangle_F M\|_F}.$$

Moreover, if X is a multiple of M , (6.3) holds trivially. Furthermore (6.5) follows in the same way from

$$2 \sum_{k=2}^m \frac{(u_1^T X u_k)^2}{|\lambda_1 - \lambda_k|} \leq |\lambda_1| \quad \text{for all } X \in \mathbb{S}_{\tilde{\mathcal{A}}} \quad \text{with } X \perp M. \quad (6.7)$$

(ii) The formulas (6.3) and (6.5) resemble very much the so-called first and second Hadamard variation formula, cf. [64, Chapter 1.3]. At least in the case when the spectrum of M contains only simple eigenvalues, the proof we give is similar to the one in [64].

Before we come to the full proof of Theorem 6.1, we sketch its main idea in a simplified setting to give some intuition about the argument.

If M is a local maximizer of (6.1), then there is a neighborhood $\mathcal{U} \subset \mathbb{S}_{\tilde{\mathcal{A}}}$ of M , such that $\|X\| \leq \|M\|$ for every $X \in \mathcal{U}$. Hence for every $X \in \tilde{\mathcal{A}}$, the function

$$f_X : \gamma \rightarrow \frac{\|M + \gamma X\|}{\|M + \gamma X\|_F} \quad (6.8)$$

has a local maximum in $\gamma = 0$. Furthermore, it is enough to restrict ourselves to matrices $X \in \mathbb{S}_{\tilde{\mathcal{A}}}$ with $X \perp M$. Let now

$$(M + \gamma X)u_j(\gamma) = \lambda_j(\gamma)u_j(\gamma), \quad j = 1, \dots, m, \quad (6.9)$$

be the spectral decomposition of $M + \gamma X$ with eigenvalues $\lambda_j(\gamma)$ and eigenvectors $u_j(\gamma)$. For simplicity, we assume for now that $\lambda_j(\gamma)$ and $u_j(\gamma)$ depend smoothly on γ . Observe, that $u_j = u_j(0)$ and $\lambda_j = \lambda_j(0)$. Due to $\|M + \gamma X\|_F^{-1} = (1 + \gamma^2)^{-1/2} = 1 - \gamma^2/2 + o(\gamma^2)$, we obtain for $\gamma \rightarrow 0$

$$f_X(\gamma) = (1 - \gamma^2/2) \cdot \max_{j: |\lambda_j(0)| = \|M\|} |\lambda_j(0) + \lambda_j'(0)\gamma + \lambda_j''(0)\gamma^2/2| + o(\gamma^2). \quad (6.10)$$

We conclude, that if f_X has a local maximum in $\gamma = 0$, then

$$\lambda_j'(0) = 0 \quad \text{for all } j \in \{1, \dots, m\} \quad \text{with } |\lambda_j(0)| = \|M\|. \quad (6.11)$$

In order to determine $\lambda_j''(0)$, we differentiate (6.9)

$$Mu_j'(\gamma) + Xu_j(\gamma) + \gamma Xu_j'(\gamma) = \lambda_j'(\gamma)u_j(\gamma) + \lambda_j(\gamma)u_j'(\gamma), \quad (6.12)$$

evaluate (6.12) in $\gamma = 0$ and multiply it with u_j . We obtain

$$(u_j')^T Mu_j + u_j^T Xu_j = \lambda_j'(0) + \lambda_j u_j^T u_j'.$$

We now plug in the relation $Mu_j = \lambda_j u_j$ together with $(u_j')^T u_j = 0$, which follows by differentiating the orthogonality relation $\langle u_i(\gamma), u_j(\gamma) \rangle = \delta_{i,j}$, and obtain

$$\lambda_j'(0) = u_j^T Xu_j.$$

Together with (6.11), this gives the proof of (6.6).

To prove (6.7), we study also second derivatives and distinguish between local minimizers and local maximizers. For simplicity we assume now that $\lambda_1 = \|M\| > \max\{|\lambda_2|, \dots, |\lambda_m|\}$. In this case we reformulate (6.10) using $\lambda_1'(0) = 0$ and (6.10) becomes

$$f_X(\gamma) = (1 - \gamma^2/2)(\lambda_1(0) + \lambda_1''(0)\gamma^2/2) + o(\gamma^2) = \lambda_1(0) + \frac{\lambda_1''(0) - \lambda_1(0)}{2}\gamma^2 + o(\gamma^2).$$

If f_X has a local maximum at $\gamma = 0$, again by a simple asymptotic argument for $\gamma \rightarrow 0$, we conclude that

$$\lambda_1''(0) \leq \lambda_1(0). \quad (6.13)$$

We differentiate (6.12) with $j = 1$ to obtain

$$Mu_1''(\gamma) + 2Xu_1'(\gamma) + \gamma Xu_1''(\gamma) = \lambda_1''(\gamma)u_1(\gamma) + 2\lambda_1'(\gamma)u_1'(\gamma) + \lambda_1(\gamma)u_1''(\gamma).$$

We evaluate this equation at $\gamma = 0$ and take again the inner product with u_1 , yielding

$$u_1^T Mu_1'' + 2u_1^T Xu_1' = \lambda_1''(0) + 2\lambda_1'(0)u_1^T u_1' + \lambda_1 u_1^T u_1''.$$

Using $u_1^T Mu_1'' = \lambda_1 u_1^T u_1''$ and $u_1^T u_1' = 0$, the equation becomes

$$\lambda_1''(0) = 2u_1^T Xu_1'. \quad (6.14)$$

For eliminating u'_1 , we multiply (6.12) for $j = 1$ with $u_k, k \neq 1$ at $\gamma = 0$. This gives

$$u_k^T M u'_1 + u_k^T X u_1 = \lambda'_1(0) u_k^T u_1 + \lambda_1 u_k^T u'_1.$$

Using $u_k^T M u'_1 = \lambda_k u_k^T u'_1$ and $u_k^T u_1 = 0$, this can be reformulated as $u_k^T u'_1 = (u_k^T X u_1)/(\lambda_1 - \lambda_k)$ for $\lambda_1 \neq \lambda_k$. Hence

$$u'_1 = \sum_{k=1}^m \langle u'_1, u_k \rangle u_k = \sum_{k=2}^m \frac{(u_k^T X u_1)}{\lambda_1 - \lambda_k} u_k,$$

which together with (6.13) and (6.14) gives (6.7).

In the argument above we made heavy use of the additional requirement of smooth dependence of the spectral decomposition of $M + \gamma X$ on the parameter γ . We will show now, that the same is true even without such an assumption.

Proof of Theorem 6.1.

Step 1. Proof of (6.3)

Let us assume, that $M \in \tilde{\mathcal{A}}$ is fixed and that f_X has local maximum at $\gamma = 0$ for $X \in \tilde{\mathcal{A}}$ with $\|X\|_F = 1$ and $X \perp M$. Hence, for $|\gamma|$ small, we have

$$\begin{aligned} \|M\| &\geq \frac{\|M + \gamma X\|}{\|M + \gamma X\|_F} \geq \left(1 - \gamma^2/2 + o(\gamma^2)\right) \cdot \max_{j=1, \dots, m} |u_j^T (M + \gamma X) u_j| \\ &= \max_{j=1, \dots, m} \left| \lambda_j(0) + \gamma u_j^T X u_j \right| + O(\gamma^2). \end{aligned}$$

Considering $j \in \{1, \dots, m\}$ with $|\lambda_j(0)| = \|M\|$ and $|\gamma|$ small, we arrive at (6.3).

Step 2. Proof of (6.5)

We derive (6.5) under the assumption that $\lambda_1 = \|M\|$ and $\lambda_1 \notin \{\lambda_2, \dots, \lambda_m\}$. If $\lambda_1 = -\|M\|$, the result follows by considering $-M$ instead of M .

Let again $M u_j = \lambda_j u_j$ be the singular value decomposition of M . Then

$$\begin{aligned} \|M + \gamma X\| &= \sup_{\|\sigma\|_2 \leq 1} \left(\sum_{i=1}^m \sigma_i u_i \right)^T (M + \gamma X) \left(\sum_{j=1}^m \sigma_j u_j \right) \\ &= \sup_{\|\sigma\|_2 \leq 1} \left(\sum_{i,j=1}^m \sigma_i \sigma_j u_i^T M u_j + \gamma \sum_{i,j=1}^m \sigma_i \sigma_j u_i^T X u_j \right) \\ &= \sup_{\|\sigma\|_2 \leq 1} \left(\sum_{i=1}^m \sigma_i^2 \lambda_i + \gamma \sum_{i,j=1}^m \sigma_i \sigma_j A_{ij} \right) =: \sup_{\|\sigma\|_2 \leq 1} f(\sigma), \end{aligned} \tag{6.15}$$

where $A_{ij} = u_i^T X u_j = A_{ji}$. We will use an approximate solution of the Lagrange's multiplier equations to estimate $\|M + \gamma X\|$ from below.

We set the constraint condition $g(\sigma) = \|\sigma\|_2^2 = 1$ and use Lagrange's multiplier theorem on

$$\theta(\sigma, \nu) := f(\sigma) + \nu(g(\sigma) - 1).$$

This leads to equations

$$\begin{aligned} \frac{\partial \theta}{\partial \nu} &= g(\sigma) - 1 = 0, \\ \frac{\partial \theta}{\partial \sigma_j} &= 2\sigma_j \lambda_j + 2\gamma \sum_{i=1}^m \sigma_i A_{ij} + \nu \cdot 2\sigma_j = 0, \quad j = 1, \dots, m. \end{aligned} \tag{6.16}$$

For $j = 1$ we use $A_{11} = u_1^T X u_1 = 0$ and (6.16) becomes

$$\sigma_1(\lambda_1 + \nu) = -\gamma \sum_{j=2}^m \sigma_j A_{1j}. \quad (6.17)$$

If $j \geq 2$, we reduce (6.16) by the following observation. The optimal value of σ in (6.15) for $\gamma = 0$ is $\sigma = e_1 = (1, 0, \dots, 0)^T$. We therefore expect that for $|\gamma|$ small, the optimal value of σ in (6.15) will be close to e_1 , i.e. $\sigma_2, \dots, \sigma_m$ are expected to be of order γ . The values A_{ij} with $i, j \geq 2$ therefore come into the value of $f(\sigma)$ only in the third order in γ and may be neglected. Then (6.16) becomes

$$\sigma_j(\lambda_j + \nu) = -\gamma \sigma_1 A_{1j}.$$

Finally, (6.17) shows that ν is close to $-\lambda_1$. We are then naturally led to choose σ according to the equations

$$\sum_{j=1}^m \bar{\sigma}_j^2 = 1, \quad \bar{\sigma}_1 \neq 0 \quad \text{and} \quad \frac{\bar{\sigma}_k}{\bar{\sigma}_1} = \gamma \cdot \frac{u_1^T X u_k}{\lambda_1 - \lambda_k}, \quad k = 2, \dots, m. \quad (6.18)$$

Up to the sign of $\bar{\sigma}$, there is exactly one solution to (6.18), which we plug into (6.15). This leads to

$$\begin{aligned} \|M + \gamma X\| &\geq f(\bar{\sigma}) = \sum_{j=1}^m \bar{\sigma}_j^2 \lambda_j + \gamma \sum_{i,j=1}^m \bar{\sigma}_i \bar{\sigma}_j A_{ij} \\ &= \bar{\sigma}_1^2 \lambda_1 + \sum_{k=2}^m \bar{\sigma}_k^2 \lambda_k + 2\gamma \sum_{j=2}^m \bar{\sigma}_1 \bar{\sigma}_j (u_1^T X u_j) + \gamma \sum_{i,j=2}^m \bar{\sigma}_i \bar{\sigma}_j (u_i^T X u_j) \\ &= \bar{\sigma}_1^2 \lambda_1 + \sum_{k=2}^m \lambda_k \gamma^2 \bar{\sigma}_1^2 \frac{(u_1^T X u_k)^2}{(\lambda_1 - \lambda_k)^2} + 2\gamma^2 \bar{\sigma}_1^2 \sum_{k=2}^m \frac{(u_1^T X u_k)^2}{\lambda_1 - \lambda_k} + o(\gamma^2) \\ &= \bar{\sigma}_1^2 \lambda_1 + \gamma^2 \bar{\sigma}_1^2 \sum_{k=2}^m \frac{(u_1^T X u_k)^2}{\lambda_1 - \lambda_k} \left\{ \frac{\lambda_k}{\lambda_1 - \lambda_k} + 2 \right\} + o(\gamma^2) \\ &= \bar{\sigma}_1^2 \left\{ \lambda_1 + \gamma^2 \sum_{k=2}^m \frac{(u_1^T X u_k)^2}{(\lambda_1 - \lambda_k)^2} (2\lambda_1 - \lambda_k) \right\} + o(\gamma^2). \end{aligned} \quad (6.19)$$

Furthermore, from $\|\bar{\sigma}\|_2^2 = 1$, we derive

$$\bar{\sigma}_1^2 + \sum_{k=2}^m \gamma^2 \bar{\sigma}_1^2 \frac{(u_1^T X u_k)^2}{(\lambda_1 - \lambda_k)^2} = \bar{\sigma}_1^2 \left(1 + \gamma^2 \sum_{k=2}^m \frac{(u_1^T X u_k)^2}{(\lambda_1 - \lambda_k)^2} \right) = 1,$$

which, by the Taylor theorem, leads to

$$\bar{\sigma}_1^2 = \left(1 + \gamma^2 \sum_{k=2}^m \frac{(u_1^T X u_k)^2}{(\lambda_1 - \lambda_k)^2} \right)^{-1} = 1 - \gamma^2 \sum_{k=2}^m \frac{(u_1^T X u_k)^2}{(\lambda_1 - \lambda_k)^2} + o(\gamma^2).$$

We plug this estimate into (6.19) and get

$$\begin{aligned}
f(\bar{\sigma}) &= \left(1 - \gamma^2 \sum_{k=2}^m \frac{(u_1^T X u_k)^2}{(\lambda_1 - \lambda_k)^2}\right) \cdot \left\{ \lambda_1 + \gamma^2 \sum_{k=2}^m \frac{(u_1^T X u_k)^2}{(\lambda_1 - \lambda_k)^2} (2\lambda_1 - \lambda_k) \right\} + o(\gamma^2) \\
&= \lambda_1 + \gamma^2 \sum_{k=2}^m (u_1^T X u_k)^2 \left\{ -\frac{\lambda_1}{(\lambda_1 - \lambda_k)^2} + \frac{2\lambda_1 - \lambda_k}{(\lambda_1 - \lambda_k)^2} \right\} + o(\gamma^2) \\
&= \lambda_1 + \gamma^2 \sum_{k=2}^m \frac{(u_1^T X u_k)^2}{\lambda_1 - \lambda_k} + o(\gamma^2).
\end{aligned}$$

This allows to conclude that

$$f_X(\gamma) = \frac{\|M + \gamma X\|}{\sqrt{1 + \gamma^2}} \geq f(\bar{\sigma})(1 - \gamma^2/2) = \lambda_1 + \gamma^2 \left(\sum_{k=2}^m \frac{(u_1^T X u_k)^2}{\lambda_1 - \lambda_k} - \frac{\lambda_1}{2} \right) + o(\gamma^2).$$

If f_X has local maximum at $\gamma = 0$, the coefficient at γ^2 has to be smaller or equal to zero, giving (6.5).

Step 3. Uniqueness of the largest eigenvalue

We proceed by contradiction. Let (6.4) be fulfilled and let $M \in \tilde{\mathcal{A}}$ with $\|M\|_F = 1$ be a local maximizer of (6.2) with $\lambda_1 = \lambda_2 = \|M\|$. The case $\lambda_1 = \lambda_2 = -\|M\|$ follows in the same manner. Taking $X \in \mathbb{S}_{\tilde{\mathcal{A}}}$ with $X \perp M$ and considering again the function f_X from (6.8), we can write

$$\begin{aligned}
f_X(\gamma) &= \frac{\|M + \gamma X\|}{\|M + \gamma X\|_F} \geq \sup_{(\sigma_1, \sigma_2): \sigma_1^2 + \sigma_2^2 = 1} (\sigma_1 u_1 + \sigma_2 u_2)^T (M + \gamma X) (\sigma_1 u_1 + \sigma_2 u_2) + o(\gamma) \\
&= \|M\| + \gamma \sup_{(\sigma_1, \sigma_2): \sigma_1^2 + \sigma_2^2 = 1} \{ \sigma_1^2 u_1^T X u_1 + \sigma_2^2 u_2^T X u_2 + 2\sigma_1 \sigma_2 u_1^T X u_2 \} + o(\gamma).
\end{aligned}$$

If f_X has a local maximum at $\gamma = 0$, we choose (σ_1, σ_2) equal to $(1, 0)$, $(0, 1)$, or $(1, 1)/\sqrt{2}$, respectively. We conclude that

$$u_1^T X u_1 = u_2^T X u_2 = u_1^T X u_2 = 0. \quad (6.20)$$

If $X \in \tilde{\mathcal{A}}$ is not orthogonal to M , we apply (6.20) to $\frac{X - \langle X, M \rangle_F M}{\|X - \langle X, M \rangle_F M\|_2}$, cf. Remark 6, and obtain

$$\begin{aligned}
u_1^T X u_1 &= \langle X, M \rangle_F \cdot \|M\| = u_2^T X u_2, \\
u_1^T X u_2 &= 0.
\end{aligned}$$

We set $X_j = P_{\tilde{\mathcal{A}}}(a_j \otimes a_j)$ and $\mathcal{E}_j = X_j - a_j \otimes a_j$. Then $X_j \in \tilde{\mathcal{A}}$ and we derive from these conditions

$$\begin{aligned}
\langle u_1, a_j \rangle^2 + u_1^T \mathcal{E}_j u_1 &= \langle u_2, a_j \rangle^2 + u_2^T \mathcal{E}_j u_2, \quad j = 1, \dots, m, \\
\langle u_1, a_j \rangle \cdot \langle u_2, a_j \rangle &= -u_1^T \mathcal{E}_j u_2, \quad j = 1, \dots, m.
\end{aligned}$$

Solving these equations for $\langle u_1, a_j \rangle^2$, we arrive at

$$\begin{aligned}
\langle u_1, a_j \rangle^2 &\leq \frac{|u_2^T \mathcal{E}_j u_2 - u_1^T \mathcal{E}_j u_1| + \sqrt{|u_2^T \mathcal{E}_j u_2 - u_1^T \mathcal{E}_j u_1|^2 + 4(u_1^T \mathcal{E}_j u_2)^2}}{2} \\
&\leq \frac{2|u_2^T \mathcal{E}_j u_2 - u_1^T \mathcal{E}_j u_1| + 2|u_1^T \mathcal{E}_j u_2|}{2} \\
&= |u_2^T \mathcal{E}_j u_2 - u_1^T \mathcal{E}_j u_1| + |u_1^T \mathcal{E}_j u_2| \leq 3\|\mathcal{E}_j\|. \quad (6.21)
\end{aligned}$$

By assumption $\mathcal{S}(a_1, \dots, a_m) \leq \varepsilon$, Lemma 5.2, and (6.21), we then obtain

$$\begin{aligned} (1 - \varepsilon)^2 &= (1 - \varepsilon)^2 \|u_1\|_2^2 \leq \|A^T u_1\|_2^2 = \sum_{j=1}^m \langle u_1, a_j \rangle^2 \leq 3 \sum_{j=1}^m \|\mathcal{E}_j\| \\ &\leq 3 \sum_{j=1}^m \|(P_{\tilde{\mathcal{A}}} - P_{\mathcal{A}})(a_j \otimes a_j)\|_F \leq 3m \|P_{\tilde{\mathcal{A}}} - P_{\mathcal{A}}\|_{F \rightarrow F}, \end{aligned}$$

which leads to a contradiction. This finishes the proof of Theorem 6.1. \square

6.2 Approximation of weights

We show how to use Theorem 6.1 to develop approximation schemes for sums of ridge functions. We proceed in two steps. In the first step we identify vectors $\hat{a}_1, \dots, \hat{a}_m \in \mathbb{R}^m$, which approximate the true ridge profiles a_1, \dots, a_m . In the second step (see Section 7) we define with their help a function \hat{f} , which is the uniform approximation of f .

We show, how to use the conditions (6.3) and (6.5) to analyze the minimization problem (6.2). First, we summarize the notation and assumptions used throughout this section. We assume that

- $a_1, \dots, a_m \in \mathbb{R}^m$ are the unknown weights/ridge profiles,
- $\mathcal{A} = \text{span}\{a_j \otimes a_j, j = 1, \dots, m\} \subset \mathbb{R}^{m \times m}$,
- the vectors a_1, \dots, a_m are ε -nearly-orthonormal, i.e., there is an orthonormal basis w_1, \dots, w_m , such that $\left(\sum_{j=1}^m \|a_j - w_j\|_2^2\right)^{1/2} = \varepsilon > 0$,
- $\hat{\mathcal{A}} = \text{span}\{w_j \otimes w_j, j = 1, \dots, m\}$,
- $\tilde{\mathcal{A}}$ is the approximation of \mathcal{A} available after the first step with $\|P_{\mathcal{A}} - P_{\tilde{\mathcal{A}}}\|_{F \rightarrow F} \leq \eta$ (Algorithm 4.1 and Theorem 4.2),
- by Lemma 5.4 we then have $\|P_{\hat{\mathcal{A}}} - P_{\tilde{\mathcal{A}}}\|_{F \rightarrow F} \leq \|P_{\hat{\mathcal{A}}} - P_{\mathcal{A}}\|_{F \rightarrow F} + \|P_{\mathcal{A}} - P_{\tilde{\mathcal{A}}}\|_{F \rightarrow F} \leq 4\varepsilon + \eta =: \nu$.

We start with several lemmas needed later on. We will use throughout the notation just introduced.

Lemma 6.2. *Let $Z \in \hat{\mathcal{A}}$ and $\nu < 1$. Then*

$$\|P_{\tilde{\mathcal{A}}}(Z)\|_F \leq \|Z\|_F \leq \frac{1}{1 - \nu} \cdot \|P_{\tilde{\mathcal{A}}}(Z)\|_F.$$

In particular, $P_{\tilde{\mathcal{A}}}$ is bijective as a map from $\hat{\mathcal{A}}$ to $\tilde{\mathcal{A}}$.

Proof. Let $Z \in \hat{\mathcal{A}}$. Then $\|P_{\tilde{\mathcal{A}}}Z\|_F \leq \|Z\|_F$ and

$$\|P_{\tilde{\mathcal{A}}}Z\|_F \geq \|P_{\hat{\mathcal{A}}}(Z)\|_F - \|(P_{\tilde{\mathcal{A}}} - P_{\hat{\mathcal{A}}})(Z)\|_F \geq \|Z\|_F - \nu \|Z\|_F = (1 - \nu) \|Z\|_F.$$

The inequality implies the injectivity of $P_{\tilde{\mathcal{A}}}$ on $\hat{\mathcal{A}}$ and from Theorem 4.2 we know that $\dim(\tilde{\mathcal{A}}) = \dim(\mathcal{A}) = m$, hence $P_{\tilde{\mathcal{A}}}$ is also surjective. \square

Lemma 6.2 ensures that for any $M \in \tilde{\mathcal{A}}$ with $\|M\|_F = 1$ there exists $Z = \sum_k \sigma_k w_k \otimes w_k \in \hat{\mathcal{A}}$ such that $M = P_{\tilde{\mathcal{A}}}(Z)$ and

$$1 \leq \left\| \sum_{k=1}^m \sigma_k w_k \otimes w_k \right\|_F = \|\sigma\|_2 \leq \frac{1}{1-\nu}. \quad (6.22)$$

We will use this property repetitively below, especially for M being a local maximizer of (6.1).

If $X = w_j \otimes w_j$ and $\|w_j\|_2 = \|u\|_2 = 1$, then

$$\|Xu\|_2^2 = \|\langle w_j, u \rangle w_j\|_2^2 = |\langle w_j, u \rangle|^2 = (u^T w_j)(w_j^T u) = u^T Xu.$$

If $X = P_{\tilde{\mathcal{A}}}(w_j \otimes w_j)$ instead, we expect the difference between $\|Xu\|_2^2$ and $u^T Xu$ to be small. This statement is made precise in the following lemma.

Lemma 6.3. *Let $W_j = w_j \otimes w_j$, $X = P_{\tilde{\mathcal{A}}}(W_j)$ and $\|u\|_2 = 1$. Then*

$$\left| \|Xu\|_2^2 - u^T Xu \right| \leq 2\nu.$$

Proof. Indeed, using $W_j = P_{\hat{\mathcal{A}}}(W_j) = W_j^2$ we obtain

$$\begin{aligned} \left| \|Xu\|_2^2 - u^T Xu \right| &= \left| \langle P_{\tilde{\mathcal{A}}}(W_j)u, P_{\tilde{\mathcal{A}}}(W_j)u \rangle - u^T P_{\tilde{\mathcal{A}}}(W_j)u \right| \\ &= \left| u^T [P_{\tilde{\mathcal{A}}}(W_j)P_{\tilde{\mathcal{A}}}(W_j) - P_{\tilde{\mathcal{A}}}(W_j)] u \right| \leq \|[P_{\tilde{\mathcal{A}}}(W_j)]^2 - P_{\tilde{\mathcal{A}}}(W_j)\|_F \\ &\leq \|[P_{\tilde{\mathcal{A}}}(W_j)]^2 - P_{\tilde{\mathcal{A}}}(W_j)P_{\hat{\mathcal{A}}}(W_j)\|_F + \|P_{\tilde{\mathcal{A}}}(W_j)P_{\hat{\mathcal{A}}}(W_j) - P_{\tilde{\mathcal{A}}}(W_j)\|_F \\ &= \|P_{\tilde{\mathcal{A}}}(W_j)(P_{\tilde{\mathcal{A}}} - P_{\hat{\mathcal{A}}})(W_j)\|_F + \|P_{\tilde{\mathcal{A}}}(W_j)W_j - P_{\hat{\mathcal{A}}}(W_j)W_j + P_{\hat{\mathcal{A}}}(W_j) - P_{\tilde{\mathcal{A}}}(W_j)\|_F \\ &= \|P_{\tilde{\mathcal{A}}}(W_j)(P_{\tilde{\mathcal{A}}} - P_{\hat{\mathcal{A}}})(W_j)\|_F + \|(P_{\hat{\mathcal{A}}} - P_{\tilde{\mathcal{A}}})(W_j)(\text{Id} - W_j)\|_F \leq 2\nu. \quad \square \end{aligned}$$

We show that the local maximizers M of (6.1) are (possibly after replacing M by $-M$) nearly positive semi-definite.

Lemma 6.4. *Let $\nu \leq 1/4$ and let M be a local maximizer of (6.2) with $\|M\| = \lambda_1 \geq \lambda_2 \geq \dots \geq \lambda_m$ being its eigenvalues. Then*

$$\lambda_m \geq -\frac{2\nu}{\lambda_1} - 4\nu. \quad (6.23)$$

Proof. We denote again $W_j = w_j \otimes w_j$. We use again Lemma 6.2 and the bijectivity of $P_{\tilde{\mathcal{A}}}$ as mapping from $\hat{\mathcal{A}}$ onto $\tilde{\mathcal{A}}$, which allows us to write M as $M = P_{\tilde{\mathcal{A}}}\left(\sum_{k=1}^m \sigma_k W_k\right)$ for suitable $\sigma_1, \dots, \sigma_m$.

This allows us to use Cauchy-Schwarz inequality and (6.22) to estimate λ_m

$$\begin{aligned}
\lambda_m &= u_m^T M u_m = \sum_{j=1}^m \sigma_j \langle P_{\tilde{\mathcal{A}}}(W_j), u_m \otimes u_m \rangle_F \\
&= \sum_{j=1}^m \sigma_j \langle W_j, u_m \otimes u_m \rangle_F + \sum_{j=1}^m \sigma_j \langle (P_{\tilde{\mathcal{A}}} - P_{\hat{\mathcal{A}}})(W_j), u_m \otimes u_m \rangle_F \\
&\geq (\min_j \sigma_j) \sum_{j=1}^m \langle w_j, u_m \rangle^2 + \left\langle (P_{\tilde{\mathcal{A}}} - P_{\hat{\mathcal{A}}}) \left(\sum_{j=1}^m \sigma_j W_j \right), u_m \otimes u_m \right\rangle_F \quad (6.24) \\
&\geq (\min_j \sigma_j) - \|P_{\hat{\mathcal{A}}} - P_{\tilde{\mathcal{A}}}\|_{F \rightarrow F} \cdot \left\| \sum_{j=1}^m \sigma_j W_j \right\|_F \\
&\geq (\min_j \sigma_j) - \frac{\nu}{1 - \nu}.
\end{aligned}$$

To estimate $\min_j \sigma_j$ from below, we plug $X = P_{\tilde{\mathcal{A}}}(W_j)$ into (6.3) to obtain

$$u_1^T P_{\tilde{\mathcal{A}}}(W_j) u_1 = \lambda_1 \langle P_{\tilde{\mathcal{A}}}(W_j), M \rangle_F.$$

We observe now that from $\|P_{\tilde{\mathcal{A}}} - P_{\hat{\mathcal{A}}}\|_F \leq \nu$, we have $|u_1^T (P_{\tilde{\mathcal{A}}} - P_{\hat{\mathcal{A}}})(W_j) u_1| \leq \nu$, implying $u_1^T (P_{\tilde{\mathcal{A}}} - P_{\hat{\mathcal{A}}})(W_j) u_1 \geq -\nu$ and

$$\begin{aligned}
-\nu &\leq \langle w_j, u_1 \rangle^2 + u_1^T (P_{\tilde{\mathcal{A}}} - P_{\hat{\mathcal{A}}})(W_j) u_1 = u_1^T W_j u_1 + u_1^T (P_{\tilde{\mathcal{A}}} - P_{\hat{\mathcal{A}}})(W_j) u_1 \\
&= u_1^T P_{\tilde{\mathcal{A}}}(W_j) u_1 = \lambda_1 \langle P_{\tilde{\mathcal{A}}}(W_j), M \rangle_F = \lambda_1 \left\langle P_{\tilde{\mathcal{A}}}(W_j), P_{\tilde{\mathcal{A}}} \left(\sum_{k=1}^m \sigma_k W_k \right) \right\rangle_F. \quad (6.25)
\end{aligned}$$

By Lemma 6.2, we obtain $\|P_{\tilde{\mathcal{A}}}(W_j)\|_F \geq (1 - \nu)\|W_j\|_F = 1 - \nu$. If $\sigma_j < 0$ for any j , we combine this with (6.25) to derive

$$\begin{aligned}
-\nu/\lambda_1 &\leq \sigma_j \|P_{\tilde{\mathcal{A}}}(W_j)\|_F^2 + \left\langle P_{\tilde{\mathcal{A}}}(W_j), P_{\tilde{\mathcal{A}}} \left(\sum_{k \neq j} \sigma_k W_k \right) \right\rangle_F \\
&\leq \sigma_j (1 - \nu)^2 + \left\langle P_{\tilde{\mathcal{A}}}(W_j) - W_j, \sum_{k \neq j} \sigma_k W_k \right\rangle_F \\
&= \sigma_j (1 - \nu)^2 + \left\langle (P_{\tilde{\mathcal{A}}} - P_{\hat{\mathcal{A}}})(W_j), \sum_{k \neq j} \sigma_k W_k \right\rangle_F.
\end{aligned}$$

By Cauchy-Schwarz inequality and (6.22), we may further estimate

$$\begin{aligned}
-\nu/\lambda_1 &\leq \sigma_j (1 - \nu)^2 + \|(P_{\tilde{\mathcal{A}}} - P_{\hat{\mathcal{A}}})(W_j)\|_F \cdot \left\| \sum_{k \neq j} \sigma_k W_k \right\|_F \\
&\leq \sigma_j (1 - \nu)^2 + \|\sigma\|_2 \cdot \|(P_{\tilde{\mathcal{A}}} - P_{\hat{\mathcal{A}}})(W_j)\|_F \leq \sigma_j (1 - \nu)^2 + \frac{\nu}{1 - \nu}.
\end{aligned}$$

We conclude that

$$\min_{j=1, \dots, m} \sigma_j \geq -\left(\frac{\nu}{\lambda_1} + \frac{\nu}{1 - \nu} \right) \cdot \frac{1}{(1 - \nu)^2},$$

which we insert into (6.24) and the result follows by simple algebraic computations for $\nu \leq 1/4$. \square

The recovery algorithm based on the optimization problem (6.2) is quite straightforward. We show that the eigenvector corresponding to the largest eigenvalue of any of its local maximizers is actually close to one of the ridge profiles.

Algorithm 6.1.

- Let M be a local maximizer of (6.2).
- If $\|M\|$ is not an eigenvalue of M , replace M by $-M$.
- Denote by $\lambda_1 \geq \lambda_2 \geq \dots \geq \lambda_m$ the eigenvalues of M arranged in decreasing order.
- Take the eigenvalue decomposition of M , i.e. $M = \sum_{j=1}^m \lambda_j u_j \otimes u_j$.
- Put $\hat{a} := u_1$.

The performance of Algorithm 6.1 is guaranteed by the following theorem.

Theorem 6.5. *If $0 < \nu < 1/(cm)$, for a suitable constant $c > 6$, then there is $j_0 \in \{1, \dots, m\}$, such that the vector \hat{a} found by Algorithm 6.1 satisfies $\|\hat{a} - a_{j_0}\|_2 \leq 5\nu$.*

The proof of this theorem, which we report below, is fundamentally based on proving the following bound

$$\|M\| = \lambda_1 \geq 1 - c'\nu, \quad (6.26)$$

for some $c' > 0$ and for any local maximizers M of (6.2). This will allow to ensure a sufficient spectral gap to apply Wedin's bound (Theorem 10.2) for showing good approximation properties of \hat{a} as in Algorithm 6.1 to one of the ridge directions a_1, \dots, a_m . We shall obtain (6.26) by a bootstrap argument: first we need to establish a weaker bound

$$\lambda_1 > \frac{\nu}{1 - \nu},$$

and use it for deducing (6.26).

Lemma 6.6. *Assume $0 < \nu < 1/(6m)$. Let M be any of the local maximizers of (6.2) with $\lambda_1 = \|M\|$. Then*

$$\|Xu_1\|_2^2 \leq \lambda_1^2 \cdot \frac{1 + \langle X, M \rangle_F^2}{2} + 3\nu \quad (6.27)$$

for any $X \in \tilde{\mathcal{A}}$ such that $\|X\|_F \leq 1$. Furthermore,

$$\lambda_1 > \frac{\nu}{1 - \nu}. \quad (6.28)$$

Proof. Let M be any of the local maximizers of (6.2) with $\lambda_1 = \|M\|$. Further let $X \in \tilde{\mathcal{A}}$. We estimate the left-hand side of (6.5) using orthonormality of $\{u_1, \dots, u_m\}$ and (6.3)

$$\begin{aligned} 2 \sum_{k=2}^m \frac{(u_1^T Xu_k)^2}{\lambda_1 - \lambda_k} &\geq 2 \min\left(\frac{1}{\lambda_1 - \lambda_k}\right) \sum_{k=2}^m (u_1^T Xu_k)^2 = \frac{2}{\lambda_1 - \lambda_m} \sum_{k=2}^m \langle Xu_1, u_k \rangle^2 \\ &= \frac{2}{\lambda_1 - \lambda_m} \left(\|Xu_1\|_2^2 - \langle Xu_1, u_1 \rangle^2 \right) \\ &= \frac{2}{\lambda_1 - \lambda_m} \left(\|Xu_1\|_2^2 - \lambda_1^2 \langle X, M \rangle_F^2 \right). \end{aligned}$$

Together with (6.5), this leads to

$$\frac{2}{\lambda_1 - \lambda_m} \left(\|Xu_1\|_2^2 - \lambda_1^2 \langle X, M \rangle_F^2 \right) \leq \lambda_1 (\|X\|_F^2 - \langle X, M \rangle_F^2).$$

If moreover $\|X\|_F \leq 1$, $\nu \leq \frac{1}{4}$, and using (6.23) we conclude that

$$\begin{aligned} \|Xu_1\|_2^2 &\leq \frac{\lambda_1(\lambda_1 - \lambda_m)}{2} (\|X\|_F^2 - \langle X, M \rangle_F^2) + \lambda_1^2 \langle X, M \rangle_F^2 \\ &\leq \frac{\lambda_1(\lambda_1 - \lambda_m)}{2} + \frac{\lambda_1(\lambda_1 + \lambda_m)}{2} \langle X, M \rangle_F^2 \\ &= \lambda_1^2 \cdot \frac{1 + \langle X, M \rangle_F^2}{2} - \lambda_1 \lambda_m \cdot \frac{1 - \langle X, M \rangle_F^2}{2} \\ &\leq \lambda_1^2 \cdot \frac{1 + \langle X, M \rangle_F^2}{2} + 2\lambda_1 \left(\frac{\nu}{\lambda_1} + 2\nu \right) \cdot \frac{1 - \langle X, M \rangle_F^2}{2} \\ &\leq \lambda_1^2 \cdot \frac{1 + \langle X, M \rangle_F^2}{2} + 3\nu. \end{aligned}$$

The proof of (6.28) follows easily from $\lambda_1 > 1/\sqrt{m}$ and $\nu < 1/(6m)$. \square

Proof of Theorem 6.5. Let M be any of the local maximizers of (6.2) with $\lambda_1 = \|M\|$. We denote again $W_j = w_j \otimes w_j$ and assume that there exists $Z = \sum_{k=1}^m \sigma_k W_k \in \hat{\mathcal{A}}$ such that $M = P_{\tilde{\mathcal{A}}} Z$. For $j \in \{1, \dots, m\}$ fixed and $X = P_{\tilde{\mathcal{A}}} W_j$ we apply by Lemma 6.3 and obtain

$$\|Xu_1\|_2^2 \geq u_1^T X u_1 - 2\nu = \lambda_1 \langle X, M \rangle_F - 2\nu.$$

Using (6.27), we then arrive at

$$\lambda_1 \langle X, M \rangle_F - 2\nu \leq \lambda_1^2 \cdot \frac{1 + \langle X, M \rangle_F^2}{2} + 3\nu,$$

which can be further rewritten as

$$0 \leq \lambda_1^2 - 1 + (1 - \lambda_1 \langle X, M \rangle_F)^2 + 10\nu. \quad (6.29)$$

Further we use (6.22) and estimate λ_1 from above

$$\begin{aligned} \lambda_1 &= u_1^T M u_1 = u_1^T (P_{\tilde{\mathcal{A}}} - P_{\hat{\mathcal{A}}})(Z) u_1 + u_1^T Z u_1 \leq \|(P_{\tilde{\mathcal{A}}} - P_{\hat{\mathcal{A}}})(Z)\|_F + \sum_{k=1}^m \sigma_k u_1^T W_k u_1 \\ &\leq \nu \|Z\|_F + \sum_{k=1}^m \sigma_k \langle w_k, u_1 \rangle^2 \leq \frac{\nu}{1 - \nu} + \max_{j=1, \dots, m} \sigma_j. \end{aligned} \quad (6.30)$$

From Lemma 6.6 and in particular by (6.28) we deduce that

$$\max_{j=1, \dots, m} \sigma_j \geq \lambda_1 - \frac{\nu}{1 - \nu} > 0.$$

Hence there exists certainly some j for which $\sigma_j > 0$. If $\sigma_j > 0$, we put $X = P_{\tilde{\mathcal{A}}} W_j$, $Z'_j = \sum_{k \neq j} \sigma_k W_k$ and get

$$\begin{aligned} \langle X, M \rangle_F &= \langle P_{\tilde{\mathcal{A}}} W_j, P_{\tilde{\mathcal{A}}} Z \rangle_F = \langle P_{\tilde{\mathcal{A}}} W_j, P_{\tilde{\mathcal{A}}} (\sigma_j W_j + Z'_j) \rangle_F \\ &= \sigma_j \langle P_{\tilde{\mathcal{A}}} W_j, W_j \rangle_F + \langle W_j, (P_{\tilde{\mathcal{A}}} - P_{\hat{\mathcal{A}}})(Z'_j) \rangle_F \\ &= \sigma_j \langle W_j, W_j \rangle_F + \sigma_j \langle (P_{\tilde{\mathcal{A}}} - P_{\hat{\mathcal{A}}}) W_j, W_j \rangle_F + \langle W_j, (P_{\tilde{\mathcal{A}}} - P_{\hat{\mathcal{A}}})(Z'_j) \rangle_F \\ &\geq \sigma_j \cdot (1 - \nu) - \nu \|\sigma\|_2 \geq \sigma_j \cdot (1 - \nu) - \frac{\nu}{1 - \nu}. \end{aligned}$$

We conclude, that there is $j_0 \in \{1, \dots, m\}$ with

$$\langle P_{\tilde{\mathcal{A}}} W_{j_0}, M \rangle_F \geq (1 - \nu) \max_{j=1, \dots, m} \sigma_j - \frac{\nu}{1 - \nu}. \quad (6.31)$$

Combining (6.31) with (6.30), we obtain for $\nu \leq 1/4$

$$\begin{aligned} \langle P_{\tilde{\mathcal{A}}} W_{j_0}, M \rangle_F &\geq \left(\lambda_1 - \frac{\nu}{1 - \nu} \right) \cdot (1 - \nu) - \frac{\nu}{1 - \nu} \\ &= \lambda_1(1 - \nu) - \nu \frac{2 - \nu}{1 - \nu} \geq \lambda_1(1 - \nu) - \frac{5\nu}{2} \end{aligned}$$

and

$$0 \leq 1 - \lambda_1 \langle P_{\tilde{\mathcal{A}}} W_{j_0}, M \rangle_F \leq 1 - \lambda_1^2(1 - \nu) + \frac{5\lambda_1\nu}{2}. \quad (6.32)$$

Finally, (6.29) with (6.32) give

$$\begin{aligned} 0 &\leq \lambda_1^2 - 1 + \left(1 - \lambda_1^2(1 - \nu) + \frac{5\lambda_1\nu}{2} \right)^2 + 10\nu \\ &= \lambda_1^2(\lambda_1^2 - 1) + \nu \left\{ -2\lambda_1^4 + \nu\lambda_1^4 + 2\lambda_1^2 + \frac{25}{4}\lambda_1^2\nu + 5\lambda_1 - 5\lambda_1^3(1 - \nu) + 10 \right\} \\ &\leq \lambda_1^2(\lambda_1^2 - 1) + \tilde{c}\nu, \end{aligned}$$

where elementary calculus and the condition $\nu < 1/6$ show that we can take $\tilde{c} = 15$.

It follows that there exists an absolute constant $\nu_0 > 0$ such that if $0 < \nu \leq \nu_0$, the latter inequality allows only two possibilities, namely $\lambda_1 \geq 1 - c'\nu$ and $\lambda_1 \leq c''\sqrt{\nu}$, for some absolute constants $c', c'' > 0$. Finally, choosing $c > (c'')^2$ large, the second option is in contradiction with $\lambda_1 \geq 1/\sqrt{m}$ and $\nu < 1/(cm)$. Therefore, there exists $c' > 0$ such that

$$\lambda_1 \geq 1 - c'\nu.$$

A detailed inspection of the argument above shows that we can take $\nu_0 = .01$, $c'' = \sqrt{15}$, $c' = 10$ and $c = 16$, but we stress that we did not try to optimize the numerical values of these constants.

Finally, we apply Wedin's bound, Theorem 10.2 in the Appendix, to

$$\tilde{B} = M = \sum_{j=1}^m |\lambda_j| \text{sign} \lambda_j u_j \otimes u_j \quad \text{and} \quad B = \sum_{k=1}^m |\sigma_k| \text{sign} \sigma_k w_k \otimes w_k.$$

We assume without loss of generality that $\sigma_1 = \max_{k=1, \dots, m} |\sigma_k|$. We observe that

$$\|\tilde{B} - B\|_F = \|P_{\tilde{\mathcal{A}}}(B) - B\|_F = \|(P_{\tilde{\mathcal{A}}} - P_{\hat{\mathcal{A}}})(B)\|_F \leq \nu \|B\|_F = \nu \|\sigma\|_2 \leq \frac{\nu}{1 - \nu}.$$

Furthermore, elementary calculations show that

$$\lambda_1 > 3/4 \quad \text{and} \quad \max_{k=2, \dots, m} |\sigma_k| < 1/4 \quad (6.33)$$

for $\nu \leq \nu_0$ sufficiently small. Indeed, the first inequality in (6.33) follows from $\|\lambda\|_2 \leq 1$ and $\lambda_1 \geq 1 - c'\nu$. And $\|\sigma\|_2 \leq 1/(1 - \nu)$ together with (6.30) and

$$\sigma_1 \geq \lambda_1 - \frac{\nu}{1 - \nu} \geq 1 - \left(\frac{1}{1 - \nu} + c' \right) \nu$$

imply the second inequality in (6.33).

We deduce that we can choose $\bar{\alpha} \geq \frac{1}{2}$ in Theorem 10.2 for $0 < \nu < \nu_0$ small enough, i.e.,

$$\min_{k=2,\dots,m} |\lambda_1 - \sigma_k| \geq \bar{\alpha} \geq 1/2 \quad \text{and} \quad |\lambda_1| \geq \bar{\alpha} \geq 1/2,$$

are verified for $0 < \nu < \nu_0$ small enough. We therefore obtain $\|u_1 \otimes u_1 - w_1 \otimes w_1\|_F \leq 4\nu$. After a possible sign change of w_1 , we can assume that $\langle u_1, w_1 \rangle \geq 0$ and obtain

$$16\nu^2 \geq \|u_1 \otimes u_1 - w_1 \otimes w_1\|_F^2 = 2(1 - \langle u_1, w_1 \rangle)^2 \geq 2(1 - \langle u_1, w_1 \rangle) = \|u_1 - w_1\|_2^2$$

and, finally,

$$\|u_1 - a_1\|_2 \leq \|u_1 - w_1\|_2 + \|w_1 - a_1\|_2 \leq 4\nu + \varepsilon \leq 5\nu.$$

□

Theorem 6.5 shows that every local maximizer of (6.2) lies close to some of the matrices $a_j \otimes a_j$ and, by Algorithm 6.1, allows for recovery of an approximation of a_j . We conclude this section by proving conversely that every $a_j \otimes a_j$ can be approximated by a local maximizer of (6.1).

Proposition 6.7. *Assume $\nu \leq 1/24$. Then for any $a_j \otimes a_j$ there exists a local maximizer M of (6.1) such that*

$$\|a_j \otimes a_j - M\| \leq 2\varepsilon + \sqrt{6\nu}.$$

Proof. Let us consider the mapping

$$\Phi : X \rightarrow \frac{P_{\hat{\mathcal{A}}}(X)}{\|P_{\hat{\mathcal{A}}}(X)\|_F}$$

from $\{X \in \hat{\mathcal{A}} : \|X\|_F = 1\}$ onto $\{Y \in \tilde{\mathcal{A}} : \|Y\|_F = 1\}$. We denote again $W_j = w_j \otimes w_j$ and, by triangle inequality,

$$\|\Phi(W_j)\| = \frac{\|P_{\tilde{\mathcal{A}}}(W_j)\|}{\|P_{\hat{\mathcal{A}}}(W_j)\|_F} \geq \frac{\|P_{\hat{\mathcal{A}}}(W_j)\| - \|(P_{\hat{\mathcal{A}}} - P_{\tilde{\mathcal{A}}})(W_j)\|_F}{\|W_j\|_F} \geq 1 - \nu$$

and, similarly,

$$\|\Phi(X)\| \leq \frac{\|X\| + \nu}{1 - \nu} \quad \text{for every } X \in \hat{\mathcal{A}} \quad \text{with} \quad \|X\|_F = 1.$$

Therefore, if $\sqrt{6\nu} \leq r \leq 1/2$, $Z \in \hat{\mathcal{A}}$ with $\|Z\|_F = 1$ and $\|Z - W_j\| = r$, then $\|Z\| \leq 1 - 3\nu$. The latter inequality follows by the fact that $Z \in \hat{\mathcal{A}}$ is linear combination of the orthonormal rank-1 matrices W_j and rather straightforward estimations of the spectral norm. Therefore, we obtain also

$$\|\Phi(Z)\| \leq \frac{1 - 2\nu}{1 - \nu} < 1 - \nu \leq \|\Phi(W_j)\|.$$

We conclude, that (for ν small enough) the maximum of $\|\cdot\|$ on the compact set $\{\Phi(Z) : Z \in \hat{\mathcal{A}}, \|Z\|_F = 1, \|Z - W_j\| \leq \sqrt{6\nu}\}$ is not attained on its boundary (with respect to the topology of the unit Frobenius sphere) and lies therefore close to W_j . More precisely there exists a local maximizer of (6.2) with $M \in \tilde{\mathcal{A}}$ such that $\|M - W_j\| \leq \sqrt{6\nu}$. By Lemma 5.2 (iv) we deduce that

$$\|a_j \otimes a_j - M\| \leq \|a_j \otimes a_j - W_j\|_F + \|M - W_j\| \leq 2\varepsilon + \sqrt{6\nu}.$$

□

6.3 A gradient-ascent algorithm

Let us describe in this section how to approach practically the solution of the nonlinear program (6.1). Let us introduce first for a given parameter $\gamma > 1$ an operator acting on the singular values of a matrix $X = U\Sigma V^T$ as follows. If $\Sigma \in \mathbb{R}^{m \times m}$ is a diagonal matrix with the singular values of X denoted by $\sigma_1 \geq \sigma_2 \geq \dots \geq \sigma_m$ on the diagonal, we set

$$\Pi_\gamma(X) = \frac{1}{\sqrt{\gamma^2\sigma_1^2 + \sigma_2^2 + \dots + \sigma_m^2}} U \begin{pmatrix} \gamma\sigma_1 & 0 & \dots & 0 \\ 0 & \sigma_2 & 0 & \dots \\ \dots & \dots & \dots & \dots \\ 0 & \dots & 0 & \sigma_m \end{pmatrix} V^T.$$

Notice that Π_γ maps any matrix X onto a matrix of unit Frobenius norm, simply exalting the first singular value and damping the others. It is not a linear operator. Furthermore, the definition of $\Pi_\gamma(X)$ is not well-posed if $\sigma_1 = \sigma_2 \geq \sigma_3 \geq \dots \geq \sigma_m$ and in this case it is assumed that a choice of ordering is made for just this one application of $\Pi_\gamma(\cdot)$. Notice that if $\sigma_1 > 1/\sqrt{2}$ and $\|X\|_F \leq 1$, then $\sigma_1 > \sigma_2$ and $\Pi_\gamma(X)$ is well-defined. This is the case for example under the conditions of Lemma 6.9.

We propose the following algorithm

Algorithm 6.2.

- Fix a suitable parameter $\gamma > 1$.
- Generate an initial guess $X^0 \in \tilde{\mathcal{A}}$ and $\|X^0\|_F = 1$ at random.
- For $\ell \geq 0$:

$$X^{\ell+1} := P_{\tilde{\mathcal{A}}} \Pi_\gamma(X^\ell).$$

This algorithm performs essentially an iteratively projected subgradient ascent method as the two operations executed within the loop are respectively a subgradient ascent step towards the maximization of the spectral norm by means of Π_γ , and a projection back onto $\tilde{\mathcal{A}}$ by $P_{\tilde{\mathcal{A}}}$.

In the following we analyze some of the convergence properties of this algorithm and its relationship to (6.1). Assume for a moment now that $\tilde{\mathcal{A}} = \mathcal{A}$ and that a_1, \dots, a_m are orthonormal. In this case the algorithm can be rather trivially analyzed and performs a straightforward computation of one of the maximizers of (6.1). As we shall see later, such maximizer in this case coincides (up to the sign) with one of the matrices $a_j \otimes a_j$.

Proposition 6.8. *Assume that $\tilde{\mathcal{A}} = \mathcal{A}$ and that a_1, \dots, a_m are orthonormal. Let $\gamma > \sqrt{2}$ and let $\|X^0\| > 1/\sqrt{\gamma^2 - 1}$. Then there exists $\mu_0 < 1$ such that*

$$\left| 1 - \|X^{\ell+1}\| \right| \leq \mu_0 \left| 1 - \|X^\ell\| \right|, \quad \text{for all } \ell \geq 0. \quad (6.34)$$

Being the sequence $(X^\ell)_\ell$ made of matrices with Frobenius norm bounded by 1, we conclude that any of its accumulation points has both unit Frobenius and spectral norm and therefore it has to coincide with one maximizer of (6.1).

Proof. We can assume now that X^0 can already be expressed in terms of its singular value decomposition $X^0 = \sum_{j=1}^m \sigma_j(X^0) a_j \otimes a_j$. Since at each iteration $\|X^\ell\|_F \leq 1$ or $1 \geq$

$\sum_{j=1}^m \sigma_j(X^\ell)^2$, it is a straightforward observation that

$$\begin{aligned} \|X^{\ell+1}\| &= \sigma_1(X^{\ell+1}) = \frac{\gamma\sigma_1(X^\ell)}{\sqrt{\gamma^2\sigma_1(X^\ell)^2 + \sigma_2(X^\ell)^2 + \dots + \sigma_m(X^\ell)^2}} \\ &\geq \frac{\gamma\sigma_1(X^\ell)}{\sqrt{(\gamma^2 - 1)\sigma_1(X^\ell)^2 + 1}}. \end{aligned} \quad (6.35)$$

Using elementary calculations we further estimate

$$\begin{aligned} 1 - \sigma_1(X^{\ell+1}) &\leq \frac{\sqrt{(\gamma^2 - 1)\sigma_1(X^\ell)^2 + 1} - \gamma\sigma_1(X^\ell)}{\sqrt{(\gamma^2 - 1)\sigma_1(X^\ell)^2 + 1}} \\ &= \frac{1 - \sigma_1(X^\ell)^2}{[\sqrt{(\gamma^2 - 1)\sigma_1(X^\ell)^2 + 1} + \gamma\sigma_1(X^\ell)]\sqrt{(\gamma^2 - 1)\sigma_1(X^\ell)^2 + 1}} \\ &\leq \frac{2(1 - \sigma_1(X^\ell))}{(\gamma^2 - 1)\sigma_1(X^\ell)^2 + 1} \end{aligned} \quad (6.36)$$

and we get (6.34) with

$$\mu_0 := \frac{2}{(\gamma^2 - 1)\|X^0\|^2 + 1} < 1.$$

□

Let us now move away from the ideal case of the $\tilde{\mathcal{A}} = \mathcal{A}$ and assume that $\tilde{\mathcal{A}}$ is only a good approximation to \mathcal{A} , in the sense that $\|P_{\tilde{\mathcal{A}}} - P_{\mathcal{A}}\|_{F \rightarrow F} \leq \epsilon$.

Remark 7. As we will see in Section 8, we can retain without loss of generality the assumption of a_1, \dots, a_m being orthonormal to a certain extent. Indeed, were $\{a_1, \dots, a_m\}$ just ϵ -near-orthonormal and $\{w_1, \dots, w_m\}$ its approximating orthonormal basis, then we could denote $\alpha_i = a_i a_i^T \in \mathbb{R}^{m \times m}$, $\omega_i = w_i w_i^T \in \mathbb{R}^{m \times m}$, $\mathcal{A} = \text{span}\{\alpha_1, \dots, \alpha_m\}$ and $\hat{\mathcal{A}} = \text{span}\{\omega_1, \dots, \omega_m\}$. It is shown in Lemma 5.2 (iv), that $\left(\sum_{i=1}^m \|\alpha_i - \omega_i\|_F^2\right)^{1/2} \leq 2\epsilon$.

Combining this result with Lemma 5.4 we would obtain $\|P_{\mathcal{A}} - P_{\hat{\mathcal{A}}}\|_{F \rightarrow F} \leq 8\epsilon$. Hence, at the price of changing slightly the reference orthonormal basis and accepting some additional approximation error of order ϵ , also in the case of a ϵ -near-orthonormal system of vectors we can reduce the arguments to the case of an orthonormal system.

Unfortunately, in the perturbed case $\tilde{\mathcal{A}} \neq \mathcal{A}$, there is no direct way of estimating $\|X^{\ell+1}\|$ by some function of $\|X^\ell\|$ as it is done in (6.35) as the singular value decompositions of the matrices $X^{\ell+1}$ and X^ℓ are in principle different. However, the singular vectors of both these matrices can be approximated by $\{a_1, \dots, a_m\}$ (we reiterate that here we assume them orthonormal) and we need to take advantage of this reference orthonormal system. First, we need to show a certain continuity property of the operator Π_γ .

Lemma 6.9. *Assume X, \tilde{X} to be two matrices in $\mathbb{R}^{m \times m}$ with respective singular value decompositions $X = U\Sigma V^T$ and $\tilde{X} = \tilde{U}\tilde{\Sigma}\tilde{V}^T$. Let us also assume that $\|X - \tilde{X}\|_F \leq \epsilon$ for some $0 < \epsilon < 1$. Assume additionally that $\max\{\|\tilde{X}\|_F, \|X\|_F\} \leq 1$ and $\sigma_1(X) \geq t_0 := \frac{1}{\sqrt{2}} + \epsilon + \xi$, for $\xi > 0$. Then, for $\gamma > 1$*

$$\|\Pi_\gamma(X) - \Pi_\gamma(\tilde{X})\|_F \leq 2^{3/2}\epsilon + \frac{4\epsilon}{\xi} + 2\sqrt{1 - (t_0 - \epsilon)} := \mu_1(\gamma, t_0, \epsilon). \quad (6.37)$$

Notice in particular that $\mu_1(\gamma, t_0, \epsilon) \rightarrow 0$ for $(t_0, \epsilon) \rightarrow (1, 0)$.

Proof. As $\sigma_1 := \sigma_1(X) \geq t_0$ and $\sigma_1^2 + \dots + \sigma_m^2 \leq 1$, we have also $\sum_{j=2}^m \sigma_j^2 \leq 1 - t_0^2$. By the assumption $\|X - \tilde{X}\|_F \leq \epsilon$ and by the well known Mirsky's bound we have that $\|\Sigma - \tilde{\Sigma}\|_F \leq \epsilon$.

Hence, $\tilde{\sigma}_1 := \sigma_1(\tilde{X}) \geq t_0 - \epsilon$, $\tilde{\sigma}_j := \sigma_j(\tilde{X}) \leq \sqrt{1 - t_0^2} + \epsilon$ and

$$|\tilde{\sigma}_1 - \sigma_j| \geq t_0 - \epsilon - \sqrt{1 - t_0^2} := \bar{\alpha} > 0,$$

for all $j = 2, \dots, m$. The positivity of $\bar{\alpha} > 0$ comes from the assumption that $t_0 = \frac{1}{\sqrt{2}} + \epsilon + \xi$. Hence, by applying Wedin's bound, Theorem 10.2 in Appendix, we easily obtain

$$\max\{\|u_1 u_1^T - \tilde{u}_1 \tilde{u}_1^T\|_F, \|v_1 v_1^T - \tilde{v}_1 \tilde{v}_1^T\|_F\} \leq \frac{2}{t_0 - \epsilon - \sqrt{1 - t_0^2}} \epsilon \leq \frac{2\epsilon}{\xi}. \quad (6.38)$$

The last inequality comes from $1 < 2(t_0 - \epsilon - \xi)^2 < (t_0 - \epsilon - \xi)^2 + t_0^2$. For later use we notice already that for any unit-norm vectors $x, \tilde{x} \in \mathbb{R}^m$

$$\|xx^T - \tilde{x}\tilde{x}^T\|_F^2 = \|xx^T\|_F^2 + \|\tilde{x}\tilde{x}^T\|_F^2 - 2\langle xx^T, \tilde{x}\tilde{x}^T \rangle_F = 2(1 - \langle x, \tilde{x} \rangle^2)$$

and

$$|\langle x, \tilde{x} \rangle| = \sqrt{1 - \frac{\|xx^T - \tilde{x}\tilde{x}^T\|_F^2}{2}} \geq 1 - \frac{\|xx^T - \tilde{x}\tilde{x}^T\|_F^2}{2}.$$

If moreover $\langle x, \tilde{x} \rangle \geq 0$, we get

$$\|x - \tilde{x}\|_2^2 = 2(1 - \langle x, \tilde{x} \rangle) \leq \|xx^T - \tilde{x}\tilde{x}^T\|_F^2. \quad (6.39)$$

We now address (6.37) by considering the estimates of different components of the singular value decompositions. We start by comparing the first singular value components. To simplify the notation, we set for $s = (s_1, \dots, s_m)$

$$\pi_\gamma(s) = \pi_\gamma(s_1, \dots, s_m) = \frac{\gamma s_1}{\sqrt{\gamma^2 s_1^2 + s_2^2 + \dots + s_m^2}}.$$

We first derive a bound for $\|u_1 \pi_\gamma(\sigma) v_1^T - \tilde{u}_1 \pi_\gamma(\tilde{\sigma}) \tilde{v}_1^T\|_F$, where $\sigma = (\sigma_1, \dots, \sigma_m)$ and similarly for $\tilde{\sigma} = (\tilde{\sigma}_1, \dots, \tilde{\sigma}_m)$.

For that, we need first to show the Lipschitz continuity of the function $s \rightarrow \pi_\gamma(s)$ on the set $S = \{s \in \mathbb{R}^m : \|s\|_2 \leq 1 \text{ and } s_1 > t_0 - \epsilon\}$. From

$$|\partial_{s_1} \pi_\gamma(s_1, \dots, s_m)| = \left| \frac{\gamma(s_2^2 + \dots + s_m^2)}{(\gamma^2 s_1^2 + s_2^2 + \dots + s_m^2)^{3/2}} \right|$$

and

$$|\partial_{s_j} \pi_\gamma(s_1, \dots, s_m)| = \left| \frac{\gamma s_1 s_j}{(\gamma^2 s_1^2 + s_2^2 + \dots + s_m^2)^{3/2}} \right| \quad \text{for } j \in \{2, \dots, m\},$$

we obtain for $s \in S$ that $1 \geq s_1 > t_0 - \epsilon$, $s_2^2 + \dots + s_m^2 \leq 1 - (t_0 - \epsilon)^2 \leq 1/2$ and

$$\begin{aligned} \|\nabla \pi_\gamma(s)\|_2^2 &= \frac{\gamma^2(s_2^2 + \dots + s_m^2)^2 + \gamma^2 s_1^2(s_2^2 + \dots + s_m^2)}{(\gamma^2 s_1^2 + s_2^2 + \dots + s_m^2)^3} \\ &= \frac{\gamma^2(s_2^2 + \dots + s_m^2)(s_1^2 + s_2^2 + \dots + s_m^2)}{(\gamma^2 s_1^2 + s_2^2 + \dots + s_m^2)^3} \leq \frac{\gamma^2/2}{(\gamma^2 s_1^2 + s_2^2 + \dots + s_m^2)^3} \leq \frac{1}{2\gamma^4 s_1^6}. \end{aligned}$$

As $\sigma, \tilde{\sigma} \in S$ and S is a convex set, we obtain by the mean value theorem,

$$|\pi_\gamma(\sigma) - \pi_\gamma(\tilde{\sigma})| \leq \|\nabla \pi_\gamma(s)\|_2 \cdot \|\sigma - \tilde{\sigma}\|_2 \leq \frac{\epsilon}{\sqrt{2}\gamma^2 s_1^3} \leq \frac{\epsilon}{\sqrt{2}\gamma^2(t_0 - \epsilon)^3}.$$

As the signs of the singular vectors can be chosen arbitrarily, we can assume without loss of generality that $\langle u_1, \tilde{u}_1 \rangle \geq 0$. Together with (6.38) and (6.39) we obtain $\|u_1 - \tilde{u}_1\|_2 \leq \frac{2\epsilon}{\xi}$ and the same holds also for $\|v_1 - \tilde{v}_1\|_2$. Therefore, we may estimate the difference of the first singular value components by

$$\begin{aligned} \|u_1 \pi_\gamma(\sigma) v_1^T - \tilde{u}_1 \pi_\gamma(\tilde{\sigma}) \tilde{v}_1^T\|_F &\leq \|(u_1 - \tilde{u}_1) \pi_\gamma(\sigma) v_1^T\|_F + \|\tilde{u}_1 (\pi_\gamma(\sigma) - \pi_\gamma(\tilde{\sigma})) v_1^T\|_F \\ &\quad + \|\tilde{u}_1 \pi_\gamma(\tilde{\sigma}) (v_1^T - \tilde{v}_1^T)\|_F \\ &\leq \|u_1 - \tilde{u}_1\|_2 + |\pi_\gamma(\sigma) - \pi_\gamma(\tilde{\sigma})| + \|v_1 - \tilde{v}_1\|_2 \\ &\leq \frac{2\epsilon}{\xi} + \frac{\epsilon}{\gamma^2(t_0 - \epsilon)^3} + \frac{2\epsilon}{\xi} \leq 2^{3/2}\epsilon + \frac{4\epsilon}{\xi}. \end{aligned} \quad (6.40)$$

We now need to estimate the difference of the other components of the singular value decomposition. Now notice that

$$\left\| \sum_{j=1}^k y_j z_j^T \right\|_F^2 = \sum_{j=1}^k \|y_j\|_2^2 \quad (6.41)$$

for arbitrary vectors $\{y_1, \dots, y_k\} \subset \mathbb{R}^m$ and orthonormal vectors $\{z_1, \dots, z_k\} \subset \mathbb{R}^m$. By applying the triangle inequality and (6.41)

$$\begin{aligned} &\left\| \sum_{j=2}^m u_j \frac{\sigma_j}{\sqrt{\gamma^2 \sigma_1^2 + \sigma_2^2 + \dots + \sigma_m^2}} v_j^T - \sum_{j=2}^m \tilde{u}_j \frac{\tilde{\sigma}_j}{\sqrt{\gamma^2 \tilde{\sigma}_1^2 + \tilde{\sigma}_2^2 + \dots + \tilde{\sigma}_m^2}} \tilde{v}_j^T \right\|_F \\ &\leq \left\| \sum_{j=2}^m u_j \frac{\sigma_j}{\sqrt{\gamma^2 \sigma_1^2 + \sigma_2^2 + \dots + \sigma_m^2}} v_j^T \right\|_F + \left\| \sum_{j=2}^m \tilde{u}_j \frac{\tilde{\sigma}_j}{\sqrt{\gamma^2 \tilde{\sigma}_1^2 + \tilde{\sigma}_2^2 + \dots + \tilde{\sigma}_m^2}} \tilde{v}_j^T \right\|_F \\ &= \left(\sum_{j=2}^m \frac{\sigma_j^2}{\gamma^2 \sigma_1^2 + \sigma_2^2 + \dots + \sigma_m^2} \right)^{1/2} + \left(\sum_{j=2}^m \frac{\tilde{\sigma}_j^2}{\gamma^2 \tilde{\sigma}_1^2 + \tilde{\sigma}_2^2 + \dots + \tilde{\sigma}_m^2} \right)^{1/2} \\ &\leq \left(\frac{1 - t_0^2}{\gamma^2 t_0^2} \right)^{1/2} + \left(\frac{1 - (t_0 - \epsilon)^2}{\gamma^2 (t_0 - \epsilon)^2} \right)^{1/2} \leq 2 \frac{\sqrt{1 - (t_0 - \epsilon)^2}}{\gamma(t_0 - \epsilon)} \leq 2\sqrt{1 - (t_0 - \epsilon)}, \end{aligned} \quad (6.42)$$

as $t_0 - \epsilon > 1/\sqrt{2}$ and $\frac{\sqrt{1-u^2}}{u} \leq 2\sqrt{1-u}$ for $1 > u > 1/\sqrt{2}$. The statement now follows by adding (6.40) and (6.42). \square

Theorem 6.10. *Assume that $\|P_{\tilde{\mathcal{A}}} - P_{\mathcal{A}}\|_{F \rightarrow F} < \epsilon < 1$ and that a_1, \dots, a_m are orthonormal. Let $\|X^0\| > \max\{\frac{1}{\sqrt{\gamma^2 - 1}}, \frac{1}{\sqrt{2}} + \epsilon + \xi\}$ and $\sqrt{2} < \gamma$. Then for the iterations $(X^\ell)_{\ell \in \mathbb{N}}$ produced by Algorithm 6.2, there exists $\mu_0 < 1$ such that*

$$\limsup_{\ell \rightarrow \infty} \|1 - \|X^\ell\|\| \leq \frac{\mu_1(\gamma, t_0, \epsilon) + 2\epsilon}{1 - \mu_0} + \epsilon,$$

where $\mu_1(\gamma, t_0, \epsilon)$ is as in Lemma 6.9. The sequence $(X^\ell)_{\ell \in \mathbb{N}}$ is bounded and its accumulation points \bar{X} satisfy simultaneously the following properties

$$\|\bar{X}\|_F \leq 1 \text{ and } \|\bar{X}\| \geq 1 - \frac{\mu_1(\gamma, t_0, \epsilon) + 2\epsilon}{1 - \mu_0} - \epsilon,$$

and

$$\|P_{\mathcal{A}}\bar{X}\|_F \leq 1 \text{ and } \|P_{\mathcal{A}}\bar{X}\| \geq 1 - \frac{\mu_1(\gamma, t_0, \epsilon) + 2\epsilon}{1 - \mu_0} - 2\epsilon.$$

Proof. We denote the singular value decomposition of X^ℓ by $X^\ell = \sum_{j=1}^m \tilde{\sigma}_j^\ell u_j^\ell \otimes \tilde{v}_j^\ell$ and the one of $P_{\mathcal{A}}X^\ell$ by $P_{\mathcal{A}}X^\ell = \sum_{j=1}^m \sigma_j^\ell a_{i_j} \otimes a_{i_j}$, where i_j is a suitable rearrangement of the index set $\{1, \dots, m\}$. By Lemma 6.9 we can further develop the following estimates

$$\|X^{\ell+1}\| \leq \|P_{\mathcal{A}}X^{\ell+1}\| + \|(P_{\tilde{\mathcal{A}}} - P_{\mathcal{A}})X^{\ell+1}\| \leq \sigma_1^{\ell+1} + \|(P_{\tilde{\mathcal{A}}} - P_{\mathcal{A}})X^{\ell+1}\|_F \leq \sigma_1^{\ell+1} + \epsilon$$

and

$$\begin{aligned} \|X^{\ell+1}\| &= \|P_{\tilde{\mathcal{A}}}\Pi_\gamma(X^\ell)\| \geq \|P_{\mathcal{A}}\Pi_\gamma(X^\ell)\| - \|(P_{\tilde{\mathcal{A}}} - P_{\mathcal{A}})\Pi_\gamma(X^\ell)\| \\ &\geq \|P_{\mathcal{A}}\Pi_\gamma(X^\ell)\| - \|(P_{\tilde{\mathcal{A}}} - P_{\mathcal{A}})\Pi_\gamma(X^\ell)\|_F \geq \|P_{\mathcal{A}}\Pi_\gamma(P_{\tilde{\mathcal{A}}}X^\ell)\| - \epsilon \\ &= \|P_{\mathcal{A}}\Pi_\gamma(P_{\mathcal{A}}X^\ell) + P_{\mathcal{A}}\Pi_\gamma(P_{\tilde{\mathcal{A}}}X^\ell) - P_{\mathcal{A}}\Pi_\gamma(P_{\mathcal{A}}X^\ell)\| - \epsilon \\ &\geq \|P_{\mathcal{A}}\Pi_\gamma(P_{\mathcal{A}}X^\ell)\| - \|\Pi_\gamma(P_{\tilde{\mathcal{A}}}X^\ell) - \Pi_\gamma(P_{\mathcal{A}}X^\ell)\|_F - \epsilon \\ &\geq \frac{\gamma\sigma_1^\ell}{\sqrt{(\gamma^2 - 1)\sigma_1^{\ell^2} + 1}} - \mu_1(\gamma, t_0, \epsilon) - \epsilon. \end{aligned}$$

Hence, we obtain

$$1 - \sigma_1^{\ell+1} \leq 1 - \frac{\gamma\sigma_1^\ell}{\sqrt{(\gamma^2 - 1)\sigma_1^{\ell^2} + 1}} + \mu_1(\gamma, t_0, \epsilon) + 2\epsilon.$$

By an estimate similar to (6.36) and following the arguments given before, we conclude that

$$1 - \sigma_1^{\ell+1} \leq \mu_0(1 - \sigma_1^\ell) + \eta_0, \quad (6.43)$$

where $\eta_0 = \mu_1(\gamma, t_0, \epsilon) + 2\epsilon$. As $X^\ell = P_{\tilde{\mathcal{A}}}\Pi_\gamma(X^{\ell-1})$ and $P_{\mathcal{A}}$ and $P_{\tilde{\mathcal{A}}}$ are orthogonal projections we have that

$$\sigma_1^\ell \leq \|P_{\mathcal{A}}X^\ell\|_F \leq \|X^\ell\|_F \leq \|\Pi_\gamma(X^{\ell-1})\|_F = 1.$$

Hence, actually, the recursion (6.43) can be rewritten as

$$\begin{aligned} |1 - \sigma_1^{\ell+1}| &\leq \mu_0 |1 - \sigma_1^\ell| + \eta_0 \\ &\leq \mu_0^{\ell+1} |1 - \sigma_1^0| + \eta_0 \sum_{k=0}^{\ell} \mu_0^k. \end{aligned}$$

This implies

$$\limsup_{\ell \rightarrow \infty} |1 - \|X^\ell\|| = \limsup_{\ell \rightarrow \infty} |1 - \tilde{\sigma}_1^\ell| \leq \limsup_{\ell \rightarrow \infty} |1 - \sigma_1^\ell| + \epsilon \leq \frac{\eta_0}{1 - \mu_0} + \epsilon. \quad (6.44)$$

Since the sequence $(X^\ell)_\ell$ is bounded, it has accumulation points \bar{X} , and as a consequence of (6.44) we obtain that \bar{X} has simultaneously the following properties

$$\|\bar{X}\|_F \leq 1 \text{ and } \|\bar{X}\| \geq 1 - \frac{\eta_0}{1 - \mu_0} - \epsilon,$$

and

$$\|P_{\mathcal{A}}\bar{X}\|_F \leq 1 \text{ and } \|P_{\mathcal{A}}\bar{X}\| \geq 1 - \frac{\eta_0}{1 - \mu_0} - 2\epsilon.$$

□

Remark 8. Given the singular value decompositions $\bar{X} = \sum_{j=1}^m \bar{\sigma}_j \bar{u}_j \otimes \bar{v}_j$ and $P_{\mathcal{A}}\bar{X} = \sum_{j=1}^m \sigma_j^\infty a_{i_j} \otimes a_{i_j}$, by applying again Wedin's bound we obtain that, for instance

$$\|\bar{v}_1 \otimes \bar{v}_1 - a_{i_1} \otimes a_{i_1}\|_F \leq \frac{2}{1 - \frac{\eta_0}{1 - \mu_0} + \epsilon - \sqrt{1 - (1 - \frac{\eta_0}{1 - \mu_0})^2}} \epsilon.$$

Notice that for $\epsilon \rightarrow 0$ we obtain $\eta_0 = \mu_1(\gamma, t_0, \epsilon) + 2\epsilon \rightarrow 2\sqrt{1 - t_0}$.

7 Recovering the activation functions

The main aim of our work is to identify the structure of functions, which take the form of (1.2). Nevertheless, once the ridge directions a_j are identified or approximated, we can produce also a uniform approximation of f .

Before we come to that we clarify one technical issue of (1.2). It is easy to see, that the representation (1.2) is not unique due to the free choice of additive factors. Indeed, if we add to the profiles $(g_j)_{j=1}^m$ arbitrary constants which sum up to zero, we obtain the same function f . By simply sampling f at zero and subtracting this value from f , we may assume without loss of generality that $f(0) = 0$. If $0 = f(0) = \sum_{i=1}^m g_i(0)$ then $\{g_i(0) : i = 1, \dots, m\}$ are indeed constants with zero sum and we can subtract them term by term $f(x) = \sum_{i=1}^m (g_i(\langle a_i, x \rangle) - g_i(0))$. Consequently, we can assume without loss of generality that

$$g_1(0) = \dots = g_m(0) = 0. \quad (7.1)$$

For the uniform approximation of f fulfilling (1.2) and (7.1), let us assume that we run Algorithm 6.2 with different initial values and obtain the approximation of the ridge directions $(a_j)_{j=1}^m$ by unit-norm vectors $(\hat{a}_j)_{j=1}^m$. We then sample f along the vectors in the dual basis $(\hat{b}_j)_{j=1}^m$ to obtain an approximation of the univariate ridge profiles g_1, \dots, g_m , which are uniquely determined by (7.1). The approximation \hat{f} of f is then obtained by putting all these ingredients together. The resulting algorithm and the analysis of its performance are described below.

Algorithm 7.1.

- Let \hat{a}_j be the normalized approximations of $a_j, j = 1, \dots, m$.
- Let $(\hat{b}_j)_{j=1}^m$ be the dual basis to $(\hat{a}_j)_{j=1}^m$.
- Put $\hat{g}_j(t) := f(t\hat{b}_j), t \in (-1/\|\hat{b}_j\|_2, 1/\|\hat{b}_j\|_2)$.
- Put $\hat{f}(x) := \sum_{j=1}^m \hat{g}_j(\langle \hat{a}_j, x \rangle), \|x\|_2 \leq 1$.

We first start with an auxiliary result, which can be shown by a simple direct computation.

Lemma 7.1. *Let $I \subset \mathbb{R}$ be an interval containing zero and let $G : I \rightarrow \mathbb{R}$ be measurable. Then for any $x, y \in I$*

$$\left| \int_0^x (x-u)G(u)du - \int_0^y (y-u)G(u)du \right| \leq \max_{u \in I} |G(u)| \cdot (|x| \cdot |y-x| + |y-x|^2/2).$$

The performance of Algorithm 7.1 is then described by the following theorem.

Theorem 7.2. *Let $\mathcal{S}(a_1, \dots, a_m) \leq \varepsilon$, $\mathcal{S}(\hat{a}_1, \dots, \hat{a}_m) \leq \varepsilon'$, and $(\sum_{j=1}^m \|a_j - \hat{a}_j\|_2^2)^{1/2} \leq \eta$. Then \hat{f} constructed by Algorithm 7.1 satisfies*

$$\|f - \hat{f}\|_\infty \leq 5C_2(1 + \xi(\varepsilon, \varepsilon')) \max(\eta, \eta^2),$$

where $\xi(\varepsilon, \varepsilon') \rightarrow 0$ if $(\varepsilon, \varepsilon') \rightarrow (0, 0)$.

Proof. We use that $g_i(0) = 0$ for $i = 1, \dots, m$, $\langle a_i, x \rangle = \sum_{j=1}^m \langle \hat{a}_j, x \rangle \cdot \langle \hat{b}_j, a_i \rangle$, Taylor's formula, and estimate for $x \in \mathbb{R}^m$ with $\|x\|_2 \leq 1$

$$\begin{aligned} |f(x) - \hat{f}(x)| &= \left| \sum_{i=1}^m g_i(\langle a_i, x \rangle) - \sum_{j=1}^m \hat{g}_j(\langle \hat{a}_j, x \rangle) \right| = \left| \sum_{i=1}^m g_i(\langle a_i, x \rangle) - \sum_{j=1}^m f(\langle \hat{a}_j, x \rangle \hat{b}_j) \right| \\ &= \left| \sum_{i=1}^m g_i(\langle a_i, x \rangle) - \sum_{j=1}^m \sum_{i=1}^m g_i(\langle \hat{a}_j, x \rangle \cdot \langle \hat{b}_j, a_i \rangle) \right| \\ &\leq \sum_{i=1}^m \left| g_i(\langle a_i, x \rangle) - \sum_{j=1}^m g_i(\langle \hat{a}_j, x \rangle \cdot \langle \hat{b}_j, a_i \rangle) \right| \\ &= \sum_{i=1}^m \left| g'_i(0) \langle a_i, x \rangle - \sum_{j=1}^m g'_i(0) \langle \hat{a}_j, x \rangle \cdot \langle \hat{b}_j, a_i \rangle \right. \\ &\quad \left. + \int_0^{\langle a_i, x \rangle} (\langle a_i, x \rangle - u) g''_i(u) du - \sum_{j=1}^m \int_0^{\langle \hat{a}_j, x \rangle \cdot \langle \hat{b}_j, a_i \rangle} (\langle \hat{a}_j, x \rangle \cdot \langle \hat{b}_j, a_i \rangle - u) g''_i(u) du \right| \\ &\leq \sum_{i=1}^m \left| \int_0^{\langle a_i, x \rangle} (\langle a_i, x \rangle - u) g''_i(u) du - \int_0^{\langle \hat{a}_i, x \rangle \cdot \langle \hat{b}_i, a_i \rangle} (\langle \hat{a}_i, x \rangle \cdot \langle \hat{b}_i, a_i \rangle - u) g''_i(u) du \right| \\ &\quad + \sum_{i=1}^m \sum_{j \neq i} \left| \int_0^{\langle \hat{a}_j, x \rangle \cdot \langle \hat{b}_j, a_i - \hat{a}_i \rangle} (\langle \hat{a}_j, x \rangle \cdot \langle \hat{b}_j, a_i - \hat{a}_i \rangle - u) g''_i(u) du \right| \\ &= I + II. \end{aligned}$$

We use Lemma 7.1 and Lemma 5.2 to bound the first term by

$$\begin{aligned} I &\leq C_2 \sum_{i=1}^m \left\{ |\langle a_i, x \rangle| \cdot |\langle a_i, x \rangle - \langle \hat{a}_i, x \rangle \cdot \langle \hat{b}_i, a_i \rangle| + |\langle a_i, x \rangle - \langle \hat{a}_i, x \rangle \cdot \langle \hat{b}_i, a_i \rangle|^2 / 2 \right\} \\ &\leq C_2 \left(\sum_{i=1}^m \langle a_i, x \rangle^2 \right)^{1/2} \cdot \left(\sum_{i=1}^m |\langle a_i, x \rangle - \langle \hat{a}_i, x \rangle \cdot \langle \hat{b}_i, a_i \rangle|^2 \right)^{1/2} \\ &\quad + \frac{C_2}{2} \sum_{i=1}^m |\langle a_i, x \rangle - \langle \hat{a}_i, x \rangle \cdot \langle \hat{b}_i, a_i \rangle|^2 = I' + I'', \end{aligned}$$

where

$$\begin{aligned} I' &\leq C_2(1 + \varepsilon) \cdot \left[\left(\sum_{i=1}^m \langle a_i - \hat{a}_i, x \rangle^2 \right)^{1/2} + \left(\sum_{i=1}^m |\langle \hat{a}_i, x \rangle \cdot \langle \hat{b}_i, \hat{a}_i - a_i \rangle|^2 \right)^{1/2} \right] \\ &\leq C_2(1 + \varepsilon)\eta + C_2(1 + \varepsilon) \max_j \|\hat{b}_j\|_2 \eta \end{aligned}$$

and

$$\begin{aligned} I'' &\leq C_2 \sum_{i=1}^m \left(\langle a_i - \hat{a}_i, x \rangle^2 + |\langle \hat{a}_i, x \rangle \cdot \langle \hat{b}_i, \hat{a}_i - a_i \rangle|^2 \right) \\ &\leq C_2 \eta^2 + C_2 \max_j \|\hat{b}_j\|_2^2 \eta^2. \end{aligned}$$

Next, we estimate the second term by

$$\begin{aligned} II &\leq C_2 \sum_{i=1}^m \sum_{j=1}^m |\langle \hat{a}_j, x \rangle \cdot \langle \hat{b}_j, a_i - \hat{a}_i \rangle|^2 \leq C_2 \sum_{i,j=1}^m \langle \hat{a}_j, x \rangle^2 \cdot \|\hat{b}_j\|_2^2 \cdot \|a_i - \hat{a}_i\|_2^2 \\ &\leq C_2 \max_j \|\hat{b}_j\|_2^2 \cdot \sum_{j=1}^m \langle \hat{a}_j, x \rangle^2 \cdot \sum_{i=1}^m \|a_i - \hat{a}_i\|_2^2 \leq C_2 \max_j \|\hat{b}_j\|_2^2 \cdot (1 + \varepsilon')^2 \eta^2. \end{aligned}$$

Using Lemma 5.2 (vi) and summing up these estimates we get

$$\|f - \hat{f}\|_\infty \leq 5C_2(1 + \xi(\varepsilon, \varepsilon')) \max(\eta, \eta^2),$$

where $\xi(\varepsilon, \varepsilon') \rightarrow 0$ if $(\varepsilon, \varepsilon') \rightarrow (0, 0)$. \square

Remark 9. By triangle inequality, the parameters $\varepsilon, \varepsilon'$ and η from Theorem 7.2 satisfy $\varepsilon' \leq \varepsilon + \eta$.

8 Whitening

In Section 6 we discussed the identification of weights $\{a_i, i = 1, \dots, m\}$ under the condition that they are close to an orthonormal system. In this section, we prove that this assumption is without loss of generality. As we clarify in this section, if the accuracy of the approximation $\tilde{\mathcal{A}} \approx \mathcal{A}$ is high enough, then, also for systems of vectors $\{a_i : i = 1, \dots, m\}$, which are not ε -nearly-orthonormal, there is a constructive way, the *whitening process* we describe below, to render them ε -nearly-orthonormal. This procedure is very much inspired by the ones described in [2, 33, 36] for symmetric tensors. Again, differently from [33], we will not rely on one instance matrix/tensor, but rather search within the space $\tilde{\mathcal{A}}$ for the right whitening matrix with the necessary stability properties.

8.1 Exact whitening

In this section we explain how we can reduce our analysis to systems $a_1, \dots, a_m \in \mathbb{R}^m$ of ε -nearly-orthonormal vectors. Assume for the moment $a_1, \dots, a_m \in \mathbb{R}^m$ linearly independent unit vectors, but not necessarily orthonormal. We describe below a quite standard orthonormalization procedure, also called in recent literature whitening [2, 36] in the context of symmetric tensor decompositions. It relies on positive definite matrices from the subspace $\mathcal{A} = \text{span}\{a_i \otimes a_i : i = 1, \dots, m\}$, which can be easily characterized.

Lemma 8.1. *Let A be a $m \times m$ matrix with non-zero columns a_1, \dots, a_m and let D_λ be a diagonal matrix with real numbers $\lambda_1, \dots, \lambda_m$ on the diagonal. Then the matrix*

$$G = AD_\lambda A^T = \sum_{i=1}^m \lambda_i a_i \otimes a_i$$

is positive definite if, and only if, $\{a_1, \dots, a_m\}$ are linearly independent and $\lambda_i > 0$ for all $i = 1, \dots, m$.

Proof. Let $\{a_i : i = 1, \dots, m\}$ be linearly independent and let $\lambda_i > 0$ for all $i = 1, \dots, m$. Then, for all $x \in \mathbb{R}^m$ with $x \neq 0$,

$$x^T G x = \sum_{i=1}^m \lambda_i \langle x, a_i \rangle^2 > 0.$$

If, on the other hand, G is positive definite, then $\text{rank } A = m$ and a_1, \dots, a_m are linearly independent. Furthermore, $\lambda_i = x^T G x > 0$ for $x = A(A^T A)^{-1} e_i$ for all $i = 1, \dots, m$. \square

Proposition 8.2. *Assume we are given a symmetric and positive definite matrix*

$$G = \sum_{i=1}^m \lambda_i a_i \otimes a_i, \quad (8.1)$$

and its singular value decomposition

$$G = U D U^T,$$

where U is an orthogonal matrix and D is diagonal matrix with positive diagonal values. If we denote $W = D^{-\frac{1}{2}} U^T$ the so-called whitening matrix, then the system of vectors $\{\sqrt{\lambda_i} W a_i : i = 1, \dots, m\}$ defines an orthonormal basis and

$$I_m = W G W^T = \sum_{i=1}^m \lambda_i W a_i \otimes W a_i$$

is an orthogonal resolution of the identity.

Proof. We know that $G \in \mathcal{A}$ can be written as

$$G = U D U^T = \sum_{i=1}^m \lambda_i a_i \otimes a_i = A D_\lambda A^T, \quad (8.2)$$

where $A \in \mathbb{R}^{m \times m}$ is a matrix with columns a_1, \dots, a_m and D_λ is a diagonal matrix with $\lambda_1, \dots, \lambda_m$ on the diagonal. By Lemma 8.1, $\lambda_i > 0$ for all $i = 1, \dots, m$. Let $W := D^{-1/2} U^T$. The matrix with columns $\{\sqrt{\lambda_i} W a_i : i = 1, \dots, m\}$ coincides with $W A D_{\sqrt{\lambda}}$, where $D_{\sqrt{\lambda}}$ is a diagonal matrix with $\sqrt{\lambda_1}, \dots, \sqrt{\lambda_m}$ on the diagonal. Finally, we observe that

$$\begin{aligned} (W A D_{\sqrt{\lambda}})(W A D_{\sqrt{\lambda}})^T &= W A D_{\sqrt{\lambda}} D_{\sqrt{\lambda}} A^T W^T = W A D_\lambda A^T W^T \\ &= W G W^T = (D^{-1/2} U^T)(U D U^T)(D^{-1/2} U^T)^T = I_m, \end{aligned}$$

hence $W A D_{\sqrt{\lambda}}$ is an orthonormal matrix. \square

8.2 Perturbed whitening

Unfortunately in practice we cannot not access directly $\mathcal{A} = \text{span}\{a_i \otimes a_i : i = 1, \dots, m\} \subset \mathbb{R}^{m \times m}$, and therefore it is not possible in general to construct a matrix G as in (8.1). However, the results of Section 4 allow us to access an approximating space of symmetric matrices $\tilde{\mathcal{A}} \subset \mathbb{R}^{m \times m}$ and in the following we assume that

$$\|P_{\mathcal{A}} - P_{\tilde{\mathcal{A}}}\|_{F \rightarrow F} \leq \eta. \quad (8.3)$$

We assume that we can construct $\tilde{G} \in \tilde{\mathcal{A}}$, which is positive definite and define $G = P_{\mathcal{A}}\tilde{G}$. The existence of a positive definite $\tilde{G} \in \tilde{\mathcal{A}}$ and algorithmic ways to construct it are discussed in Section 8.3 below. We consider their spectral decompositions

$$\tilde{G} = \tilde{U}\tilde{D}\tilde{U}^T \quad \text{and} \quad G = UDU^T. \quad (8.4)$$

As $G \in \mathcal{A}$, it can be again written as in (8.2). If $\eta > 0$ is small enough, we show that G is also positive definite, i.e., that $\lambda_i > 0$ for all $i = 1, \dots, m$. We define again $W := D^{-1/2}U^T$ and its perturbed version $\tilde{W} := \tilde{D}^{-1/2}\tilde{U}^T$. Using this notation together with (8.2) and (8.4), we can quantify the effect of whitening.

Theorem 8.3. *Let $\gamma, \eta > 0$ be positive real numbers. Let $\|P_{\mathcal{A}} - P_{\tilde{\mathcal{A}}}\|_{F \rightarrow F} \leq \eta$ and let $\tilde{G} \in \tilde{\mathcal{A}}$ be positive definite with $\tilde{G} \succcurlyeq \gamma I_m$. If $\eta\|\tilde{G}\|_F < \gamma$, then $G = P_{\mathcal{A}}(\tilde{G})$ is also positive definite,*

$$\mathcal{S}(\sqrt{\lambda_1}\tilde{W}a_1, \dots, \sqrt{\lambda_m}\tilde{W}a_m) \leq \frac{\eta\|\tilde{G}\|_F}{\gamma}$$

and $\left\{ \frac{\tilde{W}a_1}{\|\tilde{W}a_1\|_2}, \dots, \frac{\tilde{W}a_m}{\|\tilde{W}a_m\|_2} \right\}$ are ε -nearly-orthonormal, for $\varepsilon = \frac{\sqrt{2}\eta\|\tilde{G}\|_F}{\gamma}$, i.e.,

$$\mathcal{S}\left(\frac{\tilde{W}a_1}{\|\tilde{W}a_1\|_2}, \dots, \frac{\tilde{W}a_m}{\|\tilde{W}a_m\|_2}\right) \leq \frac{\sqrt{2}\eta\|\tilde{G}\|_F}{\gamma} =: \varepsilon.$$

Proof. We use the estimate

$$\|G - \tilde{G}\| \leq \|G - \tilde{G}\|_F = \|(P_{\mathcal{A}} - P_{\tilde{\mathcal{A}}})(\tilde{G})\|_F \leq \eta\|\tilde{G}\|_F$$

to show that $x^T G x = x^T (G - \tilde{G}) x + x^T \tilde{G} x \geq \gamma - \|G - \tilde{G}\| \geq \gamma - \eta\|\tilde{G}\|_F > 0$ for every $x \in \mathbb{R}^m$ with $\|x\|_2 = 1$. This gives that G is positive definite.

Next, we observe that

$$(\tilde{W}AD_{\sqrt{\lambda}}) \cdot (\tilde{W}AD_{\sqrt{\lambda}})^T = \tilde{W}AD_{\lambda}A^T\tilde{W}^T = \tilde{W}G\tilde{W}^T$$

and

$$\tilde{W}\tilde{G}\tilde{W}^T = (\tilde{D}^{-1/2}\tilde{U}^T)\tilde{U}\tilde{D}\tilde{U}^T(\tilde{D}^{-1/2}\tilde{U}^T)^T = I_m.$$

Hence

$$\begin{aligned} \|(\tilde{W}AD_{\sqrt{\lambda}}) \cdot (\tilde{W}AD_{\sqrt{\lambda}})^T - I_m\|_F &= \|\tilde{W}G\tilde{W}^T - \tilde{W}\tilde{G}\tilde{W}^T\|_F = \|\tilde{W}(G - \tilde{G})\tilde{W}^T\|_F \\ &= \|\tilde{D}^{-1/2}\tilde{U}^T(G - \tilde{G})\tilde{U}\tilde{D}^{-1/2}\|_F \leq \|\tilde{D}^{-1}\| \cdot \|G - \tilde{G}\|_F, \end{aligned}$$

which, by Theorem 5.1, gives the same estimate also for $\mathcal{S}(\sqrt{\lambda_1}\tilde{W}a_1, \dots, \sqrt{\lambda_m}\tilde{W}a_m)$. The second assertion then follows simply by Lemma 5.3. \square

8.3 Finding positive definite matrices

In view of Theorem 8.3, we are interested in the following optimization problem. Given an m -dimensional subspace $\tilde{\mathcal{A}} \subset \mathbb{R}^{m \times m}$ of $m \times m$ symmetric matrices, we would like to answer two questions:

- (i) Does $\tilde{\mathcal{A}}$ contain a strictly positive matrix?
- (ii) And, if this is the case, which positive definite matrix in $\tilde{\mathcal{A}}$ achieves the smallest ratio between its Frobenius norm and its smallest eigenvalue?

Both these tasks can be solved by the following max-min problem

$$\max_{\substack{\tilde{A} \in \tilde{\mathcal{A}} \\ \|\tilde{A}\|_F=1}} \min_{\substack{x \in \mathbb{R}^m \\ \|x\|_2=1}} x^T \tilde{A} x. \quad (8.5)$$

Indeed, the maximizer of (8.5) is the matrix from $\tilde{\mathcal{A}}$, which has the largest minimal eigenvalue among the matrices in $\tilde{\mathcal{A}}$, which have unit Frobenius norm. Furthermore, if the value of (8.5) is zero or negative, there are no positive definite matrices in $\tilde{\mathcal{A}}$.

Theorem 8.4. *Let $\tilde{\mathcal{A}} \subset \mathbb{R}^{m \times m}$ be a subspace of $m \times m$ symmetric matrices. Let*

$$\ell(\tilde{A}) := \min_{\substack{x \in \mathbb{R}^m \\ \|x\|_2=1}} x^T \tilde{A} x$$

denote the minimal eigenvalue of $\tilde{A} \in \tilde{\mathcal{A}}$. Then $\tilde{A} \rightarrow -\ell(\tilde{A})$ is a convex function. Furthermore, the solution of the convex minimization problem

$$\alpha := \min_{\substack{\tilde{A} \in \tilde{\mathcal{A}} \\ \|\tilde{A}\|_F \leq 1}} (-\ell)(\tilde{A}) \quad (8.6)$$

satisfies $\alpha \leq 0$ with $\alpha = 0$ if, and only if, $\tilde{\mathcal{A}}$ does not contain any strictly positive definite matrix. If $\alpha < 0$, then the minimizer \tilde{A}_0 of (8.6) lies on the sphere $\{\tilde{A} \in \tilde{\mathcal{A}} : \|\tilde{A}\|_F = 1\}$ and coincides with the solution of (8.5).

Proof. If $x \in \mathbb{R}^m$ with $\|x\|_2 = 1$ is fixed, then

$$x^T \left(\frac{\tilde{A} + \tilde{B}}{2} \right) x = \frac{x^T \tilde{A} x + x^T \tilde{B} x}{2} \geq \frac{\ell(\tilde{A}) + \ell(\tilde{B})}{2}.$$

Taking the infimum over $\|x\|_2 = 1$, we get $\ell(\tilde{A}/2 + \tilde{B}/2) \geq \ell(\tilde{A})/2 + \ell(\tilde{B})/2$. This implies that the function $\tilde{A} \rightarrow \ell(\tilde{A})$ is concave. Hence $-\ell$ is convex. As $(-\ell)(0) = 0$, we have $\alpha \leq 0$.

If $\alpha = 0$, then $(-\ell)(\tilde{A}) \geq 0$ or, equivalently, $\ell(\tilde{A}) \leq 0$ for every $\tilde{A} \in \tilde{\mathcal{A}}$ and $\tilde{\mathcal{A}}$ does not contain any strictly positive definite matrix.

If $\alpha < 0$, then the minimizer of (8.6) lies on the boundary of the optimization domain due to $\ell(t\tilde{A}) = t\ell(\tilde{A})$ for every $t > 0$. Hence, in this case,

$$\max_{\substack{\tilde{A} \in \tilde{\mathcal{A}} \\ \|\tilde{A}\|_F=1}} \min_{\substack{x \in \mathbb{R}^m \\ \|x\|_2=1}} x^T \tilde{A} x = \max_{\substack{\tilde{A} \in \tilde{\mathcal{A}} \\ \|\tilde{A}\|_F=1}} \ell(\tilde{A}) = - \min_{\substack{\tilde{A} \in \tilde{\mathcal{A}} \\ \|\tilde{A}\|_F=1}} (-\ell)(\tilde{A}) = - \min_{\substack{\tilde{A} \in \tilde{\mathcal{A}} \\ \|\tilde{A}\|_F \leq 1}} (-\ell)(\tilde{A}) = -\alpha.$$

□

Remark 10. Theorem 8.4 translates (8.5) into a convex optimization problem (8.6), cf. [5, 6]. It can be solved in two steps. First, we want to decide if $\tilde{\mathcal{A}}$ contains a strictly positive matrix. If $\{\tilde{A}_1, \dots, \tilde{A}_m\} \subset \tilde{\mathcal{A}}$ is any orthonormal basis of $\tilde{\mathcal{A}}$, we would like to know if there is a $\xi = (\xi_1, \dots, \xi_m) \in \mathbb{R}^m$, such that

$$\tilde{A} = \xi_1 \tilde{A}_1 + \dots + \xi_m \tilde{A}_m \succ 0. \quad (8.7)$$

This question is known as feasibility problem of the *linear matrix inequality* (8.7) and we refer to [6, Section 11.4] for a detailed discussion of its solution by interior-point methods. If (8.7) turns out to be feasible, then we can use (for example) an iterative projected subgradient method very much in the spirit of Section 6.3 to find the solution of (8.5).

Algorithm 8.1.

- Fix $\eta > 0$, assume f of the form (1.4).
- Denote $f^{(0)}(x) := \sum_{i=1}^m g_i^{(0)}(\langle a_i^{(0)}, x \rangle)$ with $g_i^{(0)} := g_i, a_i^{(0)} := a_i$ for $i = 1, \dots, m$.
- For $k \geq 0$, compute $\tilde{\mathcal{A}}^{(k+1)}$ by using Algorithm 4.1 with accuracy $\eta > 0$ from point values of $f^{(k)}$.
- Define $\tilde{W}^{(k+1)}$ as the whitening matrix of $\tilde{\mathcal{A}}^{(k+1)}$ using the solution of the optimization problem (8.5).
- Denote $f^{(k+1)}(x) := f^{(k)}((\tilde{W}^{(k+1)})^T x)$; observe that $f^{(k+1)}(x) = \sum_{i=1}^m g_i^{(k+1)}(\langle a_i^{(k+1)}, x \rangle)$ as in (8.8) with $a_i^{(k+1)} := \tilde{W}^{(k+1)} a_i^{(k)} / \|\tilde{W}^{(k+1)} a_i^{(k)}\|_2, i = 1, \dots, m$.

8.4 Bootstrap whitening

In view of the simple reformulation

$$f(\tilde{W}^T x) = \sum_{i=1}^m g_i(\langle a_i, \tilde{W}^T x \rangle) = \sum_{i=1}^m \tilde{g}_i(\sqrt{\tilde{\lambda}_i} \langle \tilde{W} a_i, x \rangle) = \tilde{f}(x), \quad (8.8)$$

for $\tilde{g}_i(t) = g_i(t/\sqrt{\tilde{\lambda}_i})$ and Theorem 8.3, we can further assume without loss of generality that the vectors $\{a_i : i = 1, \dots, m\}$ are ε -nearly-orthonormal in first place. However, in Section 6 we needed that ε is indeed quite small (certainly smaller than 1 to ensure that our theoretical error estimates are meaningful). In view of Theorem 8.3, this requires $\eta > 0$ in the approximation (8.3) also rather small and the identification of a reasonably well-conditioned matrix \tilde{G} .

In this section we report surprising numerical results, obtained by iterating the whitening procedure (Algorithm 8.1). So far, we have not been able to explain this phenomenon analytically, but it is consistently verified in all numerical experiments. It is related to the increasing possibility over the iterations of finding a well-conditioned matrix \tilde{G} for whitening.

By applying whitening, we can assume through (8.8) that the new function

$$\tilde{f}(x) = \sum_{i=1}^m \tilde{g}_i(\sqrt{\tilde{\lambda}_i} \tilde{W} a_i, x)$$

has ridge directions $\sqrt{\tilde{\lambda}_i} \tilde{W} a_i$ which are “more orthogonal” than the original ones a_i of $f(x) = \sum_{i=1}^m g_i(\langle a_i, x \rangle)$. Still, when the distortion parameter $\eta > 0$ is not very small (e.g., $\eta = 0.1$ for $m = 20$), the level of gained ε -near-orthonormality will become rather mild. However, if we apply again the whitening on the previously whitened vectors $\sqrt{\tilde{\lambda}_i} \tilde{W} a_i$ (for fixed accuracy $\eta > 0$), we surprisingly gain further improved ε -near-orthonormality! We implement this bootstrap procedure in Algorithm 8.1 and we show in Figure 2 corresponding numerical results.

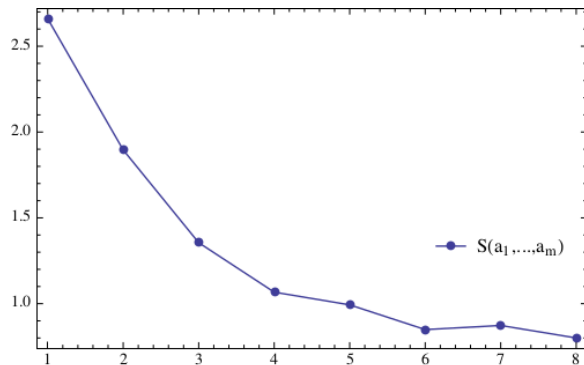

Figure 2: The values of $\mathcal{S}(a_1^{(k)}, \dots, a_m^{(k)})$ for $m = 20$ for different iterations $k = 1, \dots, 8$ of Algorithm 8.1 for fixed $\eta = 0.1$. We observe the improved level of ε -near-orthonormality of the system along the iterations of Algorithm 8.1. Starting with $\mathcal{S}(a_1^{(0)}, \dots, a_m^{(0)}) \geq \mathcal{S}(a_1^{(1)}, \dots, a_m^{(1)}) > 1$, one finally obtains $\mathcal{S}(a_1^{(6)}, \dots, a_m^{(6)}) < 1$ after $k = 6$ iterations.

Remark 11. While high accuracy of the approximation $\tilde{\mathcal{A}} \approx \mathcal{A}$ is crucial, as we just pointed out, it is important to stress that in the analysis of Section 6 the ε -near-orthonormality is merely an useful and technical assumption in order to derive in a relatively simple way theoretical error bounds on the identification of the a_i 's, see Theorem 6.5 and Theorem 6.10. Although these bounds provide robust theoretical guarantees, they seem to overestimate the actual error committed by the reconstruction Algorithms 6.1 or 6.2 if the vectors a_i 's are well-separated (perhaps after just a rough whitening) but not yet ε -near-orthonormal for ε small. So in practice we often observe that, as soon as the accuracy $\tilde{\mathcal{A}} \approx \mathcal{A}$ is good enough, even a simple whitening is already sufficient for our recovery algorithms Algorithm 6.1 or Algorithm 6.2 to recover well the a_i 's. We extensively illustrate this practical efficiency and robustness in the numerical experiments in the next section.

9 Numerical experiments

In this section we demonstrate numerically the efficiency of the pipeline of the algorithms we analyzed in the previous sections for the robust identification of the weights of a network written in compact form as $f(x) = b^T g(A^T x + \theta)$ of m nodes in dimension m , where

$A \in \mathbb{R}^{m \times m}$, $b, \theta \in \mathbb{R}^m$. Throughout the experiments we use networks with random configurations. To generate a random network we specify m and ε , which is the degree of near-orthonormality of A and sample the remaining parameters as

- A : First we draw an orthogonal $m \times m$ matrix from the Haar distribution. Then we proceed iterating the following adjustments: we perturb the singular values by Gaussian noise with a given variance, then normalize the columns, and we check whether A has reached the desired degree ε of near-orthonormality up to a tolerance of ± 0.001 ; if this does not occur, then we modify the variance of the Gaussian noise in a bisection fashion to search iteratively the right level of near-orthonormality;
- $b = (b_1, \dots, b_m)^T$ with $b_i \sim \mathcal{N}(1, 1/5)$ selected independently;
- $\theta = (\theta_1, \dots, \theta_m)$ with $\theta_i \sim \mathcal{N}(0, 1/5)$ selected independently;
- $g(t) = \tanh(t)$.

This setting corresponds to (1.2) with $g_i(t) = b_i \tanh(t + \theta_i)$.

9.1 Exact weight identification

We will consider below trials for $m = 20$. The choice of a small dimension is simply due to the necessity of running in a reasonable time a large number of trials to estimate the empirical probability of success, but the algorithms can comfortably be implemented in higher dimensions $m \approx 10^3$ on a Laptop. In this case the memory needed for storing 64 bit floating point matrices Y as appearing in Algorithm 2.1-Algorithm 4.1 is given by $m^2 \times m_{\mathcal{X}} \times 8$ bytes ≈ 8 GB). For much higher dimensions the use of HPC is needed, see Section 9.2 and Section 9.3 below.

Denote by a_1, \dots, a_m the columns of A . As clarified by Theorem 7.2 the fundamental issue is in fact the robust identification of the network weights a_i , while the identification of the rest of the network is its direct consequence. For the sake of simplicity, we present here results based on active sampling. Accordingly, we denote with $m_{\mathcal{X}}$ the number of sampled Hessians of the function f , which are computed by finite difference approximations with stepsize 0.001, cf. (4.1). For each pair $(m_{\mathcal{X}}, \varepsilon)$ of number of Hessians and near-orthonormality level, we run 60 trials. In each of the trials we first construct the subspace \tilde{A} by Algorithm 4.1 and then try to compute all $m = 20$ vectors a_1, \dots, a_m by applying Algorithm 6.2 repeatedly. One run of Algorithm 4.1 returns at random one of the a_i , therefore we need to run the algorithm at least m times to have a chance of recovering all the vectors. For the hyperparameter of number of repetitions we choose $n_{\text{rep}} = 180$. In each of the n_{rep} repetitions we carried out 100 steps of the algorithm with $\gamma = 2$ and we used this number of steps as a stopping criterion. For each of the 60 trials we get 180 vectors $V = \{v_1, \dots, v_{\text{rep}}\}$. In our numerical experiments V always contained only approximations to (some or all) original vectors a_i and no spurious cases seem ever occurring. For a given tolerance δ we measure the number of well-approximated vectors as

$$n_{\text{found}} := \# \{i \in [m] : \min\{\|v + a_i\|_2, \|v - a_i\|_2\} \leq \delta \text{ for any } v \in V\},$$

and we set $\delta = 0.05$ in our experiments. Figure 3 shows the ratio of the number of trials where $n_{\text{found}} = m$ for different degrees of near-orthonormality and amounts of approximated Hessians. From the figure, it is clear that our pipeline of the algorithms is able to reconstruct

exactly all $m = 20$ network weights a_1, \dots, a_m with high probability with a number $m_{\mathcal{X}} \approx m = 20$ of sampled Hessians, which is the information theoretical lower bound. Moreover, as shown in Figure 3, exact recovery is obtained also for levels $\varepsilon > 1$ of near-orthonormality. Even for $\varepsilon \approx 3$ the algorithm recovers all vectors with overwhelming (empirical) probability. This numerical evidence suggests that the ε -nearly-orthonormality is a quite conservative measure of separation of the vectors a_1, \dots, a_m and that in practice it is sufficient that they are enough separated and a near orthonormality is not necessary.

9.2 Exploring computational time

The previous section indicates that having around $m_{\mathcal{X}} \approx m$ (approximated) Hessians is sufficient for recovery. We use the parameters above and explore how much computational time different blocks of the algorithm pipeline need for increasing dimensionalities $m = m_{\mathcal{X}}$. Additionally, we keep the deviation from an orthonormal system constant at $\varepsilon = 1$ (which should not have much influence on the runtime anyway). We split the algorithm into three stages: the sampling and approximation of the Hessians, the realization of Algorithm 4.1 (which below we denote PCA), and finally the search of the rank-1 matrices by Algorithm 6.2. For the last stage we only measure the time needed to find one rank-1 matrix. Additionally we also track one version where we replace the SVD in stage 2 (Algorithm 4.1) by a randomized SVD [26]. The computational times of the different phases are plotted in Figure 4. As a clear disclaimer, let us stress that our computational time figures are relative to quite straightforward off the books implementations, with no particular tuning or optimization whatsoever. Hence, they should not be taken as a reference of the absolute performance of our algorithmic pipeline, rather as an illustration of our theoretical findings and an indication of feasibility, even with relatively modest computational resources. In fact, we expect that careful and optimized coding and parallelization will yield tremendous speed-ups and more efficient memory usage over the presented figures.

As mentioned above, we need to apply Algorithm 6.2 repeatedly to find all the weights a_i . An interesting question is how many times n_{rep} do we need to repeat Algorithm 6.2

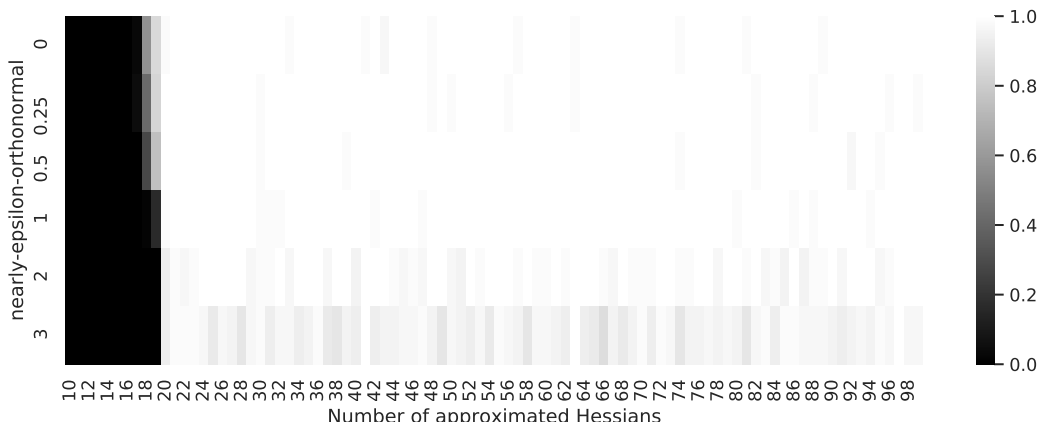

Figure 3: Phase transition diagram displaying the empirical success probability of recovering all the vectors a_1, \dots, a_m for a given number $m_{\mathcal{X}}$ of sampled Hessians and near-orthonormality level ε of the searched vectors.

with random initial iteration to be able to compute all the weights. If we assume a uniform distribution for Algorithm 6.2 to compute at random one of the weights, then our problem is equivalent to the classical coupon collector’s problem. A well known result from probability [32, Section 8.4] tells us that we need on average

$$\mathbb{E}[n_{rep}] = m \ln m + \gamma m + \frac{1}{2} + \mathcal{O}(1/m) \quad (9.1)$$

repetitions to cover all vectors, where $\gamma \approx 0.57721\dots$ is the Euler-Mascheroni constant. Large deviation bounds are also available, see, e.g., [20]. Using this as a baseline to measure the cost of the algorithm yields the cumulative results in Figure 5. It is important to notice that the showed runtime as well as the memory consumption (next section) depend heavily on the implementation, which was not extensively optimized with respect to both. However, even with this in mind, it is painfully obvious that finding a way to avoid Algorithm 6.2 picking duplicate vectors would make the algorithm much more efficient. Nevertheless, it is also clear that the procedure can be easily parallelized, using ca. $\mathbb{E}[N_{rep}]$ (9.1) processors.

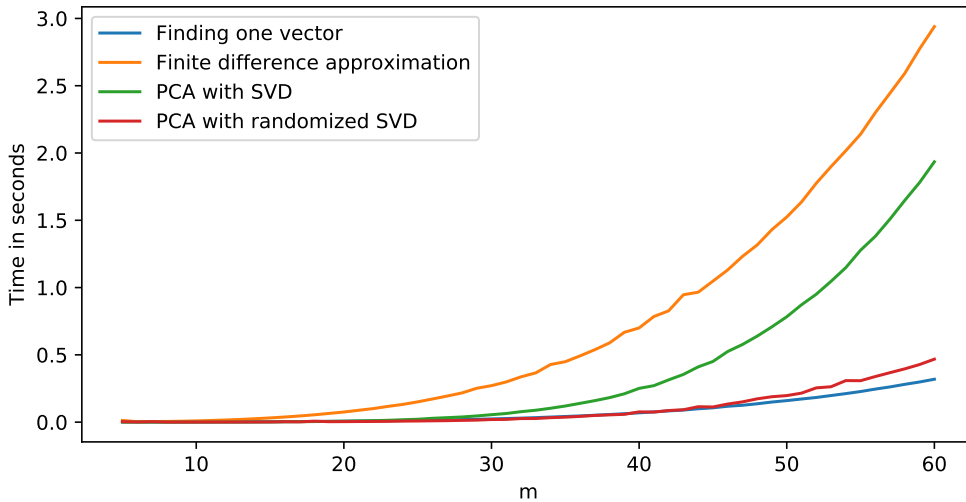

Figure 4: Time spent at the different stages of the pipeline to compute one network weight.

9.3 Exploring memory allocation

As previously, we split the algorithm into three stages and measure the consumed memory of the process for $m = 100$ and $m = 125$ (cf. Figure 6-7). The most expensive part is clearly the PCA (Algorithm 4.1). However, choosing a randomized SVD variant required only 50% of the memory in our example, without diminishing significantly accuracy. This stage needs to be further optimized with respect to memory in the future, including considering lower bit encoding etc.

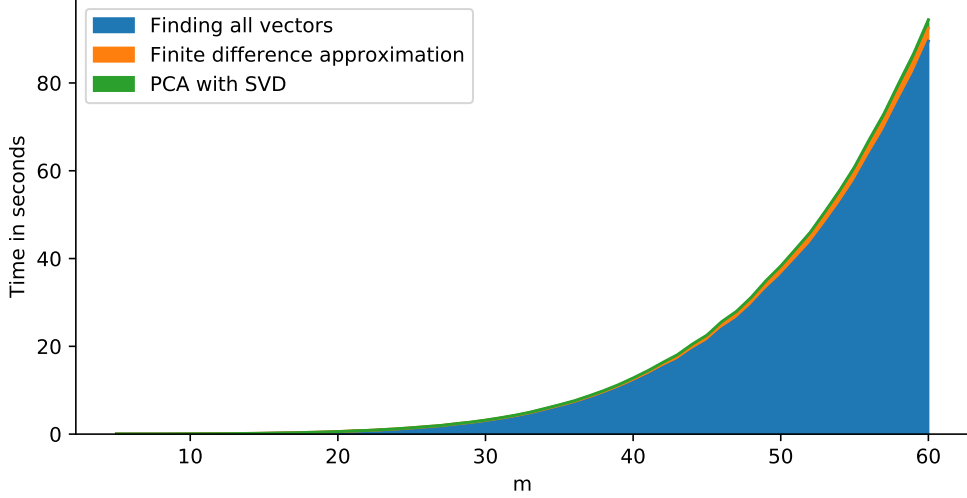

Figure 5: Cumulative time spent at the different stages of the pipeline to obtain full recovery of all vectors in a sequential implementation.

9.4 Comparison to gradient descent

A popular method for training a neural network is minimizing the misfit (here we consider the mean squared error) on the output of the network over a large number of inputs by means of gradient descent. In this section we would like to compare the behavior of our pipeline of algorithms with gradient descent we choose the same setting for both approaches. In particular, we assume that every other parameter of the network except the (inner) weights a_1, \dots, a_m is known and fixed. To be precise:

- We assume b, θ are known and fixed;
- We set $m = 20$ and $\varepsilon = 1$ (i.e. a_1, \dots, a_m will be ε -nearly-orthonormal);
- For each random network we run our method for gradually increasing number of sampled approximated Hessians and with n_{rep} sufficiently large. From the resulting vectors we compute $\hat{a}_1, \dots, \hat{a}_m$ by clustering them by k -means. Finally we record the error of the new network where A is substituted with our estimate \hat{A} on a completely new set of 10^5 datapoints generated at random uniformly on B_1^d that were not used during the previous steps. The error is measured via mean square error (MSE/ L^2 -squared) / uniform norm and we record the distance of the estimated \hat{A} to A in the Frobenius norm.
- We emulate the same procedure by using gradient descent to minimize the MSE misfit over the same training datapoints. Approximating one Hessian by finite-differences requires $1 + \frac{d^2+d}{2}$ samples. The stepsize of gradient descent method remains fixed at 0.1 and we do exactly 1000 steps for each trial.

We average everything over 10 random trial networks, the results are collected in Figure 8 and Figure 9.

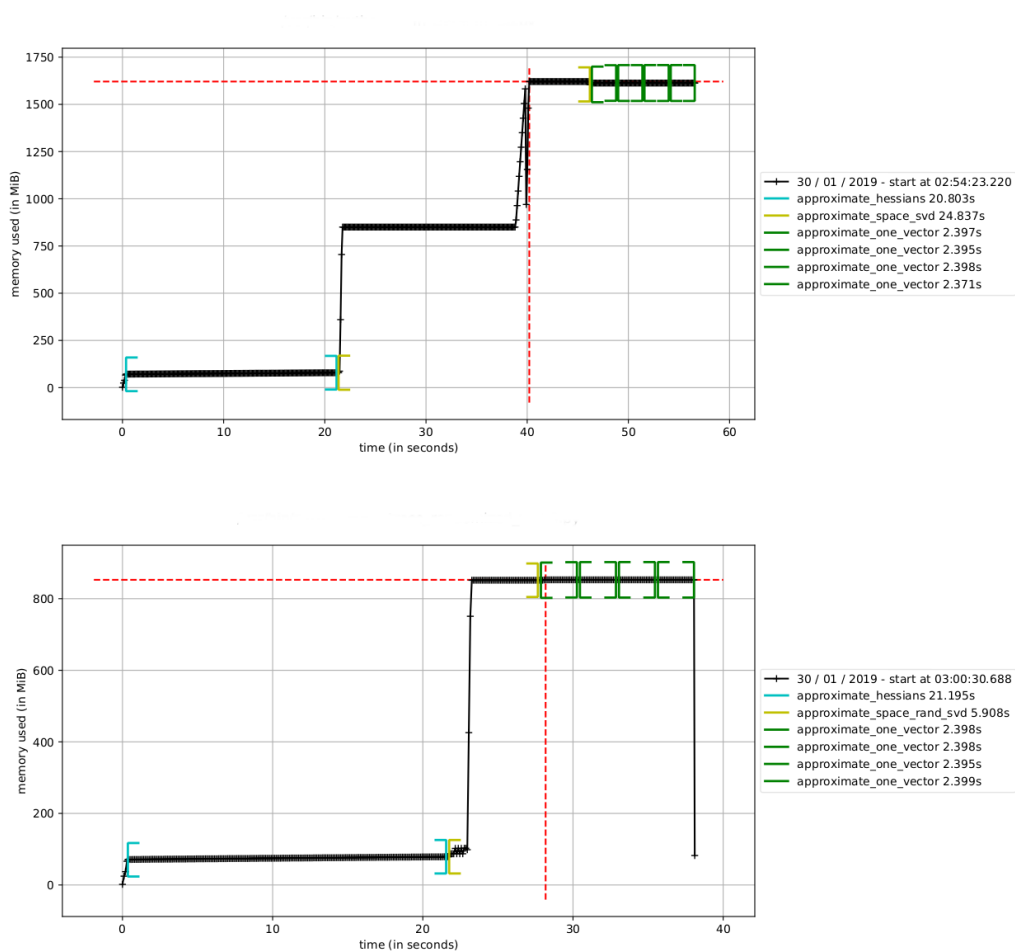

Figure 6: Memory consumption for $m = 100$. Classical SVD (top), randomized SVD (bottom). The dashed red lines indicates the cartesian coordinates (time \times memory) of the memory peak.

On the one hand, gradient descent seems to require only a very small amount of samples (≈ 50 , see the right plot in Figure 9) to converge against a very efficient local minimum representing a good approximation of the network in MSE, whereas our algorithm requires at least m Hessians. However, the generated network by gradient descent is not optimal as one can observe from the non-vanishing uniform norm approximation, see the right plot in Figure 8. On the other hand, if we have enough Hessians, then our method returns the optimal network with vanishing uniform norm discrepancy. Additionally, gradient descent will never come close to the original weight matrix A , while our algorithm is able to consistently recover a very good approximation of A , see the left plot in Figure 9.

10 Appendix

10.1 Proofs of passive sampling results

With the same proof of Lemma 2.1 we can show the following result.

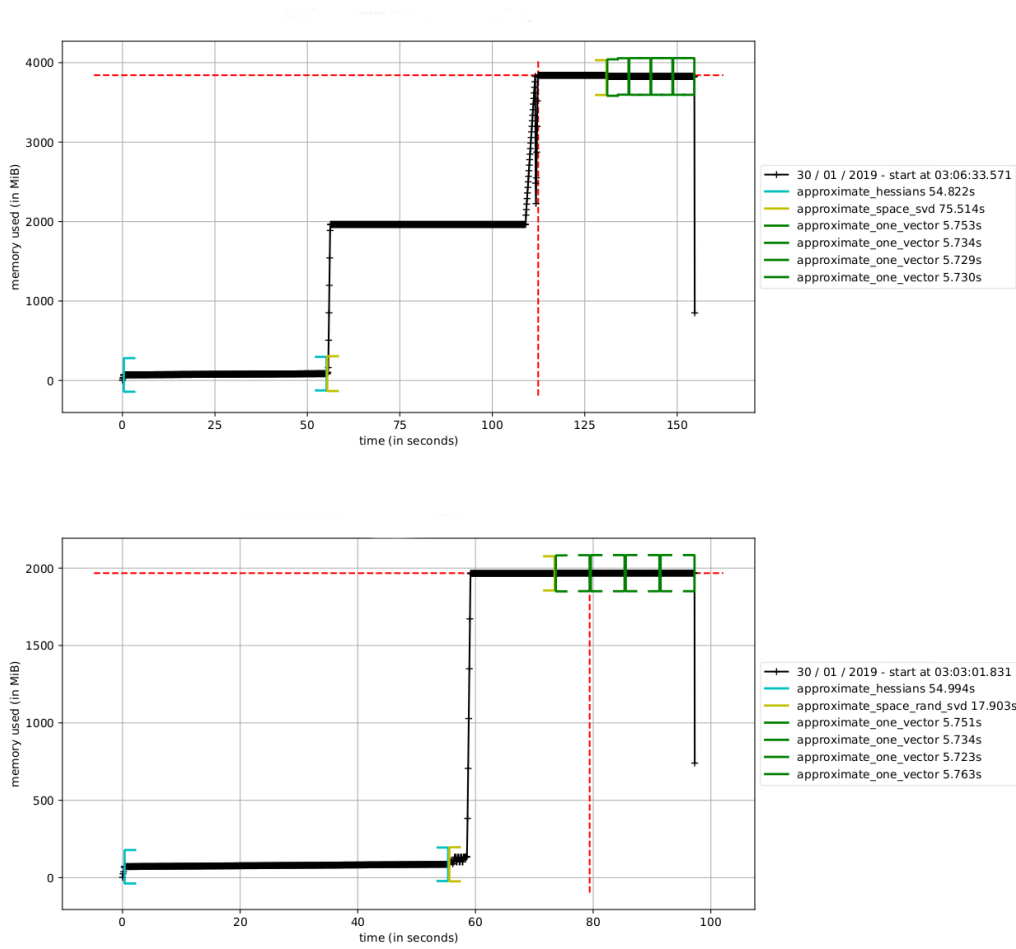

Figure 7: Memory consumption for $m = 125$. Classical SVD (top), randomized SVD (bottom). The dashed red lines indicates the cartesian coordinates (time \times memory) of the memory peak.

Lemma 10.1. *Assume the vectors $(a_i)_{i=1}^m$ linearly independent, and $\|a_i\|_2 = 1$ for all $i = 1, \dots, m$. Additionally assume*

$$C_1 := \max_{i=1, \dots, m} \max_{-1 \leq t \leq 1} |g'_i(t)| < \infty.$$

Suppose that $\sigma_m(J_{\mathcal{V}}[f]) \geq \alpha > 0$, i.e., the m^{th} singular value of the matrix $J_{\mathcal{V}}[f]$ is bounded away from zero. Then for any $s \in (0, 1)$ we have that

$$\sigma_m(X_{\mathcal{V}}) \geq \sqrt{m\chi\alpha(1-s)}$$

with probability at least $1 - m \exp\left(-\frac{m\chi\alpha s^2}{2(C_0 C_{\mathcal{V}} m)^2}\right)$.

Proof. The only difference with respect to the proof of Lemma 2.1 is in how we estimate

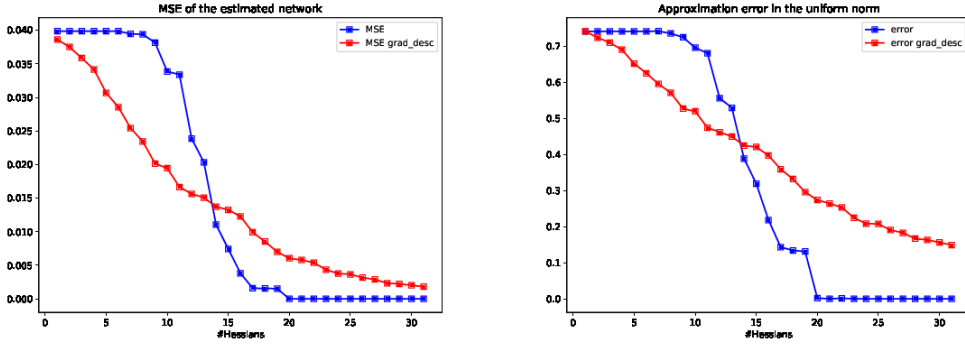

Figure 8: Average approximation error of 10 random networks with $m = 20, \varepsilon = 1$ in terms of MSE (left), uniform norm (right). The errors were measured over 10^5 datapoints generated uniform at random on the ball B_1^d .

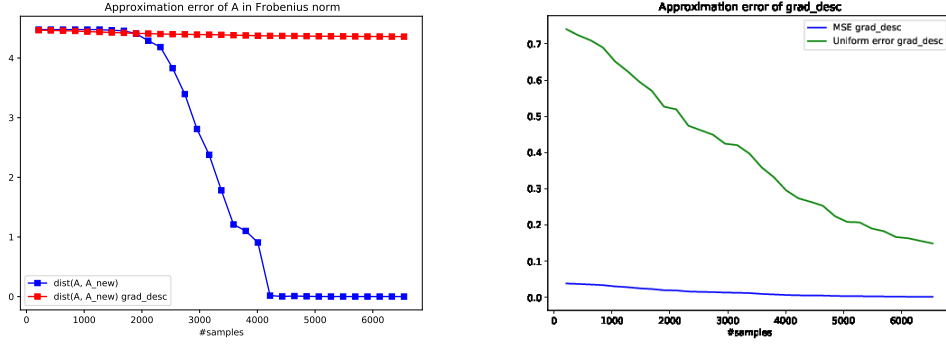

Figure 9: Approximation error of A in the Frobenius norm (left). Approximation error of gradient descent for 1-200 samples (right).

the term

$$\begin{aligned}
\sigma_1 \left(W^T \left(\int_{\mathbb{R}^d} \nabla f(x) \varphi_\nu(x) dx \right) \left(\int_{\mathbb{R}^d} \nabla f(x) \varphi_\nu(x) dx \right)^T W \right) &= \left\| \int_{\mathbb{R}^d} \nabla f(x) \varphi_\nu(x) dx \right\|_2^2 \\
&= \left\| \int_{\mathbb{R}^d} f(x) \nabla \varphi_\nu(x) dx \right\|_2^2 \leq \left(\int_{\mathbb{R}^d} |f(x)| \cdot \left\| \frac{\nabla \varphi_\nu(x)}{p(x)} \right\|_2 p(x) dx \right)^2 \leq (mC_0C_V)^2. \quad (10.1)
\end{aligned}$$

The rest follows similarly. \square

Proof of Theorem 2.3. As in the proof of Theorem 2.2

$$\|P_A - P_{\hat{A}}\|_F \leq \frac{2\|X_V - Y_V\|_F}{\sigma_m(X_V^T) - \|X_V - Y_V\|_F}. \quad (10.2)$$

By Lemma 10.1 with probability at least $1 - m \exp\left(-\frac{m\chi\alpha s^2}{2(C_0C_V m)^2}\right)$ we have

$$\sigma_m(X_V) \geq \sqrt{m\chi\alpha(1-s)}. \quad (10.3)$$

In order to estimate $\|X_{\mathcal{V}} - Y_{\mathcal{V}}\|_F$ we apply Theorem 10.5. Let $Z^k \in \mathbb{R}^{d \times m_{\mathcal{X}}}$ be a matrix with columns

$$(Z^k)_j = \frac{f(x_k) + n_k}{N} \cdot \frac{\nabla \varphi_{\nu_j}(x_k)}{p(x_k)} - \frac{1}{N} \int_{\mathbb{R}^d} f(x) \frac{\nabla \varphi_{\nu_j}(x)}{p(x)} p(x) dx$$

for $j = 1, \dots, m_{\mathcal{X}}$. Then $\mathbb{E}Z^k = 0$,

$$\|Z^k\|_F^2 = \sum_{j=1}^{m_{\mathcal{X}}} \|(Z^k)_j\|_2^2 \leq \frac{m_{\mathcal{X}}}{N^2} \cdot [2(mC_0 + C_{\mathcal{N}})C_{\mathcal{V}}]^2 = \frac{m_{\mathcal{X}}}{N^2} \cdot (2mQ)^2 =: B^2$$

and

$$\begin{aligned} \sum_{k=1}^N \mathbb{E}\|Z^k\|_F^2 &= \sum_{k=1}^N \sum_{j=1}^{m_{\mathcal{X}}} \mathbb{E}\|(Z^k)_j\|_2^2 \\ &= Nm_{\mathcal{X}} \int_{\mathbb{R}} \int_{\mathbb{R}^d} \left\| \frac{f(y) + n}{N} \cdot \frac{\nabla \varphi_{\nu}(y)}{p(y)} - \frac{1}{N} \int_{\mathbb{R}^d} f(x) \frac{\nabla \varphi_{\nu}(x)}{p(x)} p(x) dx \right\|_2^2 p(y) dy d\omega(n) \\ &\leq \frac{m_{\mathcal{X}} [2(mC_0 + C_{\mathcal{N}})C_{\mathcal{V}}]^2}{N} = \frac{m_{\mathcal{X}} (2mQ)^2}{N} =: \sigma^2, \end{aligned}$$

where ω is the probability distribution of the noise.

By Theorem 10.5, we obtain for $t = \eta\sqrt{m_{\mathcal{X}}}$ with $0 \leq \eta \leq 2mQ$

$$\begin{aligned} \mathbb{P}(\|X_{\mathcal{V}} - Y_{\mathcal{V}}\|_F \geq \eta\sqrt{m_{\mathcal{X}}}) &= \mathbb{P}\left(\left\| \sum_{k=1}^N Z^k \right\|_F \geq \eta\sqrt{m_{\mathcal{X}}}\right) \leq \exp\left(-\frac{m_{\mathcal{X}}\eta^2}{8\sigma^2} + \frac{1}{4}\right) \\ &\leq \exp\left(-\frac{\eta^2 N}{8(2mQ)^2} + \frac{1}{4}\right). \end{aligned} \quad (10.4)$$

The proof of (2.13) now follows by combining (10.2), (10.3) and (10.4) together with

$$\eta < \sqrt{\alpha(1-s)} \leq \sqrt{\alpha} \leq \sqrt{\sigma_m(J_{\mathcal{V}}[f])} \leq \sqrt{\sigma_1(J_{\mathcal{V}}[f])} \leq mC_0C_{\mathcal{V}} \leq mQ,$$

where we used also (10.1).

In order to show (2.14) and (2.15), let us fix $\eta > 0$ such that $\varepsilon = \frac{2\eta}{\sqrt{\alpha(1-s)} - \eta}$, i.e., $\eta = \frac{\varepsilon\sqrt{\alpha(1-s)}}{2+\varepsilon}$. We now choose $m_{\mathcal{X}}$ large enough to ensure that

$$\delta/2 \geq m \exp\left(-\frac{m_{\mathcal{X}}\alpha s^2}{2(mQ)^2}\right), \quad \text{i.e.} \quad m_{\mathcal{X}} \geq \frac{2(mQ)^2 \ln(2m/\delta)}{\alpha s^2},$$

and N large enough for

$$\delta/2 \geq \exp\left(-\frac{\eta^2 N}{8(2mQ)^2} + \frac{1}{4}\right).$$

We observe that for

$$N \geq \frac{32(2+\varepsilon)^2(mQ)^2 \ln(3/\delta)}{\varepsilon^2 \alpha(1-s)}$$

we can ensure $\|P_A - P_{\tilde{A}}\|_F \leq \varepsilon$, with probability at least $1 - \delta$. \square

Proof of Theorem 4.3. By Wedin's bound, we obtain as in the proof of Theorem 2.3

$$\|P_{\mathcal{A}} - P_{\tilde{\mathcal{A}}}\|_{F \rightarrow F} \leq \frac{2\|X_{\mathcal{V},2} - Y_{\mathcal{V},2}\|_F}{\sigma_m(X_{\mathcal{V},2}^T) - \|X_{\mathcal{V},2} - Y_{\mathcal{V},2}\|_F}. \quad (10.5)$$

The analogue of (2.6) and (10.1) now reads as

$$\begin{aligned} & \sigma_1 \left(P^{\mathcal{A}} \left(\int_{\mathbb{R}^d} f(x) \frac{\nabla^2 \varphi_{\nu}(x)}{p(x)} p(x) dx \right) \otimes_{\nu} \left(\int_{\mathbb{R}^d} f(x) \frac{\nabla^2 \varphi_{\nu}(x)}{p(x)} p(x) dx \right)^T (P^{\mathcal{A}})^T \right) \\ &= \left\| \int_{\mathbb{R}^d} \nabla^2 f(x) \varphi_{\nu}(x) dx \right\|_F^2 = \left\| \sum_{i=1}^m \left(\int_{\mathbb{R}^d} g_i''(\langle a_i, x \rangle) \varphi_{\nu}(x) dx \right) a_i \otimes a_i \right\|_F^2 \leq (C_2 C_{\mathcal{V},2} m)^2. \end{aligned} \quad (10.6)$$

Then for any $s \in (0, 1)$ we have that

$$\sigma_m(X_{\mathcal{V},2}) \geq \sqrt{m_{\mathcal{X}} \alpha_2 (1-s)} \quad (10.7)$$

with probability at least $1 - m \exp\left(-\frac{m_{\mathcal{X}} \alpha_2 s^2}{2(C_2 C_{\mathcal{V},2} m)^2}\right)$.

To estimate $\|X_{\mathcal{V},2} - Y_{\mathcal{V},2}\|_F$, we use again Theorem 10.5. Let $Z^k \in \mathbb{R}^{m^2 \times m_{\mathcal{X}}}$ be a matrix with columns

$$(Z^k)_j = \text{vec} \left(\frac{f(x_k) + n_k}{N} \cdot \frac{\nabla^2 \varphi_{\nu_j}(x_k)}{p(x_k)} - \frac{1}{N} \int_{\mathbb{R}^d} f(x) \frac{\nabla^2 \varphi_{\nu_j}(x)}{p(x)} p(x) dx \right)$$

for $j = 1, \dots, m_{\mathcal{X}}$. Then $\mathbb{E}Z^k = 0$,

$$\|Z^k\|_F^2 \leq m_{\mathcal{X}} [2(mC_0 + C_{\mathcal{N}})C_{\mathcal{V},2}]^2 / N^2 \leq m_{\mathcal{X}} (2mQ)^2 / N^2 =: B^2$$

and

$$\begin{aligned} \sum_{k=1}^N \mathbb{E} \|Z^k\|_F^2 &= Nm_{\mathcal{X}} \int_{\mathbb{R}} \int_{\mathbb{R}^d} \left\| \frac{f(y) + n}{N} \frac{\nabla^2 \varphi_{\nu}(y)}{p(y)} - \frac{1}{N} \int_{\mathbb{R}^d} f(x) \frac{\nabla^2 \varphi_{\nu}(x)}{p(x)} p(x) dx \right\|_F^2 p(y) dy d\omega(n) \\ &\leq \frac{m_{\mathcal{X}}}{N} [(mC_0 + C_{\mathcal{N}})C_{\mathcal{V},2} + mC_0 C_{\mathcal{V},2}]^2 \leq m_{\mathcal{X}} (2mQ)^2 / N =: \sigma^2, \end{aligned}$$

where ω is the probability distribution of the noise. By Theorem 10.5, we obtain

$$\mathbb{P}(\|X_{\mathcal{V},2} - Y_{\mathcal{V},2}\|_F > \eta \sqrt{m_{\mathcal{X}}}) = \mathbb{P} \left(\left\| \sum_{k=1}^N Z^k \right\|_F \geq \eta \sqrt{m_{\mathcal{X}}} \right) \leq \exp \left(-\frac{\eta^2 N}{8(2mQ)^2} + \frac{1}{4} \right)$$

for $0 < \eta < 2mQ$. This condition is satisfied for $\eta < \sqrt{\alpha_2(1-s)}$ by (10.6). The proof of (4.10) then follows by combining this estimate with (10.5) and (10.7).

The proof of (4.11) and (4.12) proceeds in the same manner as in the proof of Theorem 2.3. \square

10.2 Stability of the singular value decomposition

Given two matrices B and \tilde{B} with corresponding singular value decompositions

$$B = (U_1 \ U_2) \begin{pmatrix} \Sigma_1 & 0 \\ 0 & \Sigma_2 \end{pmatrix} \begin{pmatrix} V_1^T \\ V_2^T \end{pmatrix}$$

and

$$\tilde{B} = \begin{pmatrix} \tilde{U}_1 & \tilde{U}_2 \end{pmatrix} \begin{pmatrix} \tilde{\Sigma}_1 & 0 \\ 0 & \tilde{\Sigma}_2 \end{pmatrix} \begin{pmatrix} \tilde{V}_1^T \\ \tilde{V}_2^T \end{pmatrix},$$

where it is understood that two corresponding submatrices, e.g., U_1, \tilde{U}_1 , have the same size, we would like to bound the difference between V_1 and \tilde{V}_1 by the error $\|B - \tilde{B}\|_F$. As a consequence of Wedin's perturbation bound [66], see also [60, Section 7], we have the following useful result.

Theorem 10.2 (Stability of subspaces - Wedin's bound). *If there is an $\bar{\alpha} > 0$ such that*

$$\min_{\ell, \tilde{\ell}} |\sigma_{\tilde{\ell}}(\tilde{\Sigma}_1) - \sigma_{\ell}(\Sigma_2)| \geq \bar{\alpha}, \quad (10.8)$$

and

$$\min_{\tilde{\ell}} |\sigma_{\tilde{\ell}}(\tilde{\Sigma}_1)| \geq \bar{\alpha}, \quad (10.9)$$

then

$$\max\{\|\sin(\Theta(U_1, \tilde{U}_1))\|_p, \|\sin(\Theta(V_1, \tilde{V}_1))\|_p\} \leq \frac{1}{\bar{\alpha}} \|B - \tilde{B}\|_p,$$

where $\Theta(V, W)$ is the vector of the principal angles between the subspaces V and W and $\|\cdot\|_p$ is an arbitrary p -norm or Schatten- p -norm for $1 \leq p \leq \infty$. The case of $p = 2$ corresponds to the Frobenius norm and the bound further specifies as follows:

$$\max\{\|U_1 U_1^T - \tilde{U}_1 \tilde{U}_1^T\|_F, \|V_1 V_1^T - \tilde{V}_1 \tilde{V}_1^T\|_F\} \leq \frac{\sqrt{2}}{\bar{\alpha}} \|B - \tilde{B}\|_F.$$

10.3 Spectral estimates and sums of random semidefinite matrices

The value of $\sigma_m(X^T)$ can be estimated by certain matrix Chernoff bounds. The following theorem generalizes Hoeffding's inequality to sums of random semidefinite matrices and was recently presented by Tropp in [65, Corollary 5.2 and Remark 5.3], improving over results in [1], and using techniques from [55] and [51].

Theorem 10.3 (Matrix Chernoff). *Let X_1, \dots, X_n be independent random, positive-semidefinite matrices of dimension $m \times m$. Moreover suppose that*

$$\sigma_1(X_j) \leq C$$

almost surely for all $j = 1, \dots, n$. Let

$$\mu_{\min} = \sigma_m \left(\sum_{j=1}^n \mathbb{E} X_j \right)$$

be the smallest singular value of the sum of the expectations. Then

$$\mathbb{P} \left\{ \sigma_m \left(\sum_{j=1}^n X_j \right) - \mu_{\min} \leq -s \mu_{\min} \right\} \leq m \exp \left(-\frac{\mu_{\min} s^2}{2C} \right),$$

for all $s \in (0, 1)$.

Recall that for some $d_1 \times d_2$ -matrix A its spectral norm is defined as $\max(\|AA^T\|, \|A^T A\|)^{1/2}$ (i.e. its largest singular value). For $d_1 \times 1$ -matrices (i.e. vectors) this gives simply its ℓ_2 -norm.

Corollary 10.4. *Let X_1, \dots, X_N be independent, mean-zero $d_1 \times d_2$ -random matrices. Assume that*

$$\|X_j\| \leq K$$

almost surely for all $1 \leq j \leq N$, and denote

$$\sigma^2 = \max\left(\left\|\sum_{j=1}^N \mathbb{E}(X_j X_j^T)\right\|, \left\|\sum_{j=1}^N \mathbb{E}(X_j^T X_j)\right\|\right).$$

Then it holds

$$\mathbb{P}\left(\left\|\sum_{j=1}^N X_j\right\| > \eta\right) \leq (d_1 + d_2) \exp\left(-\frac{\eta^2}{2(\sigma^2 + K\eta/3)}\right).$$

We apply this result for random vectors $Y_\ell = X_\ell - X$, where $X = \mathbb{E}X_\ell$, to estimate $\|\frac{1}{N} \sum_{\ell=1}^N X_\ell - X\|$.

We shall use also the vector valued analogue of Theorem 10.3 in the form presented in [38, Proposition 7], see also [39, Chapter 6.3] and [23, Chapter 8.9].

Theorem 10.5 (Vector Bernstein inequality). *Let Z_1, \dots, Z_N be independent random vectors in \mathbb{R}^d with $\mathbb{E}Z_k = 0$ and $\|Z_k\|_2 \leq B$ almost surely for all $k = 1, \dots, N$. If $\sigma^2 \geq \sum_{k=1}^N \mathbb{E}\|Y_k\|_2^2$, then for all $0 \leq t \leq \sigma^2/B$*

$$\mathbb{P}\left(\left\|\sum_{k=1}^N Z_k\right\|_2 \geq t\right) \leq \exp\left(-\frac{t^2}{8\sigma^2} + \frac{1}{4}\right).$$

Acknowledgement

We authors wish to thank profusely the anonymous Referee for the suggestions, which greatly improved both results and presentation of the paper.

References

- [1] R. Ahlswede and A. Winter, *Strong converse for identification via quantum channel*, IEEE Trans. Inform. Theory 48(3) (2002), 569–579.
- [2] A. Anandkumar, R. Ge, and M. Janzamin, *Guaranteed non-orthogonal tensor decomposition via alternating rank-1 updates*, arXiv:1402.5180, 2014.
- [3] F. Bach, *Breaking the curse of dimensionality with convex neural networks*, J. Mach. Learn. Res. 18 (2017), 1–53.
- [4] A. L. Blum and R. L. Rivest, *Training a 3-node neural network is NP-complete*. Neural Networks 5 (1) (1992), 117–127.

- [5] S. Boyd, L. El Ghaoui, E. Feron, and V. Balakrishnan, *Linear matrix inequalities in system and control theory*, SIAM Studies in Applied Mathematics 15, Society for Industrial and Applied Mathematics (SIAM), Philadelphia, 1994.
- [6] S. Boyd and L. Vandenberghe, *Convex optimization*, Cambridge University Press, Cambridge, 2004.
- [7] T. M. Breuel, A. Ul-Hasan, M. A. Al-Azawi, and F. Shafait, *High-performance OCR for printed English and Fraktur using LSTM networks*, In: 12th International Conference on Document Analysis and Recognition (2013), 683–687.
- [8] M. D. Buhmann and A. Pinkus, *Identifying linear combinations of ridge functions*, *Adv. in Appl. Math.* 22 (1999), no. 1, 103–118.
- [9] E. J. Candès, *Ridgelets: estimating with ridge functions*, *Ann. Stat.* 31 (5) (2003), 1561–1599.
- [10] N. Carlini and D. Wagner, *Towards evaluating the robustness of neural networks*, In: 2017 IEEE Symposium on Security and Privacy (SP) (2017), pp. 39–57.
- [11] L. Chiantini and C. Ciliberto, *Weakly defective varieties*, *Trans. Amer. Math. Soc.* 354(1) (2002), 151–178.
- [12] D.C. Cireşan, U. Meier, J. Masci, and J. Schmidhuber, *Multi-column deep neural network for traffic sign classification*, *Neural Networks* 32 (2012), 333–338.
- [13] A. Cohen, I. Daubechies, R. DeVore, G. Kerkycharian, and D. Picard, *Capturing ridge functions in high dimensions from point queries*, *Constr. Approx.* 35 (2) (2012), 225–243.
- [14] P. Constantine, *Active Subspaces: Emerging Ideas for Dimension Reduction in Parameter Studies*, SIAM Spotlights 2., Society for Industrial and Applied Mathematics (SIAM), Philadelphia, 2015.
- [15] P. Constantine, E. Dow, and Q. Wang, *Active subspaces in theory and practice: Applications to kriging surfaces*, *SIAM J. Sci. Comput.* 36 (2014), pp. A1500–A1524.
- [16] Vi. De Silva and L.-H. Lim, *Tensor rank and the ill-posedness of the best low-rank approximation problem*, *SIAM J. Matrix Anal. Appl.* 30 (3) (2008), 1084–1127.
- [17] R. DeVore, K. Oskolkov, and P. Petrushev, *Approximation of feed-forward neural networks*, *Ann. Numer. Math.* 4 (1997), 261–287.
- [18] L. Devroye and L. Györfi, *Nonparametric Density Estimation*, Wiley Series in Probability and Mathematical Statistics: Tracts on Probability and Statistics, John Wiley & Sons Inc., New York, 1985.
- [19] D. L. Donoho and I. M. Johnstone, *Projection-based approximation and a duality with kernel methods*, *Ann. Stat.* 17 (1) (1989), 58–106.
- [20] P. Erdős and A. Rényi, *On a classical problem of probability theory*, *Magyar Tudományos Akadémia Matematikai Kutató Intézetének Közleményei*, 6 (1961), 215–220.

- [21] M. Fornasier, T. Klock, and M. Rauchensteiner, *Robust and resource efficient identification of two hidden layer neural networks*, arXiv: 1907.00485, 2019.
- [22] M. Fornasier, K. Schnass, and J. Vybíral, *Learning functions of few arbitrary linear parameters in high dimensions*, Found. Comput. Math. 12 (2) (2012), 229–262.
- [23] S. Foucart and H. Rauhut, *A mathematical introduction to compressive sensing*, Birkhäuser/Springer, New York, NY, 2013.
- [24] A. Graves, A.-R. Mohamed, and G. E. Hinton, *Speech recognition with deep recurrent neural networks*, In: IEEE International Conference on Acoustics, Speech and Signal Processing (ICASSP) (2013), 6645–6649.
- [25] W. Hackbusch, *Tensor Spaces and Numerical Tensor Calculus*, Springer, 2012.
- [26] N. Halko, P. G. Martinsson, and J. A. Tropp, *Finding structure with randomness: Probabilistic algorithms for constructing approximate matrix decompositions*, SIAM Rev. 53 (2) (2011), 217–288.
- [27] J. Håstad, *Tensor rank is NP-complete*, J. Algorithms 11 (4) (1990), 644–654.
- [28] Ch. J. Hillar and L.-H. Lim, *Most tensor problems are NP-hard*, J. ACM 60 (6) (2013), 1–45.
- [29] G. E. Hinton, S. Osindero, and Y. W. Teh, *A fast learning algorithm for deep belief nets*, Neural Comput. 18 (7) (2006), 1527–1554.
- [30] G. E. Hinton and R. Salakhutdinov, *Reducing the dimensionality of data with neural networks*, Science 313 (5786) (2006), 504–507.
- [31] P. J. Huber, *Projection pursuit*, Ann. Stat. 13 (2) (1985), 435–525.
- [32] R. Isaac, *The Pleasures of Probability*, Undergraduate Texts in Mathematics, New York: Springer-Verlag, pp. 80–82, 1995
- [33] M. Janzamin, H. Sedghi, and A. Anandkumar, *Beating the perils of non-convexity: guaranteed training of neural networks using tensor methods*, arXiv:1506.08473.
- [34] J. S. Judd, *Neural network design and the complexity of learning*, MIT press, 1990.
- [35] K. Kawaguchi, *Deep learning without poor local minima*, Advances in Neural Information Processing Systems (NIPS 2016).
- [36] T. G. Kolda, *Symmetric orthogonal tensor decomposition is trivial*, arXiv:1503.01375, 2015
- [37] A. Krizhevsky, I. Sutskever, and G. E. Hinton, *Imagenet classification with deep convolutional neural networks*, In: Advances in Neural Information Processing Systems (NIPS) (2012), 1–9.
- [38] R. Kueng, and D. Gross, *RIPless compressed sensing from anisotropic measurements*, Linear Algebra Appl. 441 (2014), 110–123.
- [39] M. Ledoux, M. Talagrand, *Probability in Banach Spaces: Isoperimetry and Processes*, Springer, Berlin, 1991.

- [40] K. Li, *On principal hessian directions for data visualization and dimension reduction: another application of Stein's Lemma*, J. Am. Stat. Assoc. 87 (420) (1992), 1025–1039.
- [41] X. Li, *Interpolation by ridge polynomials and its application in neural networks*, J. Comput. Appl. Math. 144 (1-2) (2002), 197–209.
- [42] W. Light, *Ridge functions, sigmoidal functions and neural networks*, Approximation theory VII, Proc. 7th Int. Symp., Austin/TX (USA) 1992, 163–206 (1993)
- [43] B. F. Logan and L. A. Shepp, *Optimal reconstruction of a function from its projections*, Duke Math. J. 42 (1975), 645–659.
- [44] S. Mayer, T. Ullrich, and J. Vybíral, *Entropy and sampling numbers of classes of ridge functions*, Constr. Appr. 42 (2) (2015), 231–264.
- [45] S. Mei, T. Misiakiewicz, A. Montanari, *Mean-field theory of two-layers neural networks: dimension-free bounds and kernel limit*, In Proceedings of the 32nd Conference on Learning Theory, volume 99, pp. 2388–2464, PMLR, 2019.
- [46] M. Mella, *Singularities of linear systems and the waring problem*, Trans. Amer. Math. Soc. 358(12) (2006), 5523–5538.
- [47] M. Mondelli and A. Montanari, *On the connection between learning two-layers neural networks and tensor decomposition*, In Proceedings of the 22nd International Conference on Artificial Intelligence and Statistics, volume 89, pp. 1051–1060, PMLR, 2019.
- [48] M. Moravčík, M. Schmid, N. Burch, V. Lisý, D. Morrill, N. Bard, T. Davis, K. Waugh, M. Johanson, and M. Bowling, *Deepstack: Expert-level artificial intelligence in heads-up no-limit poker*, Science 356, no. 6337 (2017), 508–513.
- [49] Y. Nakatsukasa, T. Soma, and A. Uschmajew, *Finding a low-rank basis in a matrix subspace*, Math. Program. 162 (1-2), Ser. A (2017), 325–361.
- [50] L. Oeding and G. Ottaviani, *Eigenvectors of tensors and algorithms for waring decomposition*, J. Symb. Comput. 54 (2013), 9–35.
- [51] R. I. Oliveira, *Sums of random Hermitian matrices and an inequality by Rudelson*, Electron. Commun. Probab. 15 (2010), 203–212.
- [52] P. P. Petrushev, *Approximation by ridge functions and neural networks*, SIAM J. Math. Anal. 30 (1) (1999), 155–189.
- [53] A. Pinkus, *Approximating by ridge functions*. Le Méhauté, Alain (ed.) et al., Surface fitting and multiresolution methods. Vol. 2 of the proceedings of the 3rd international conference on Curves and surfaces, held in Chamonix-Mont-Blanc, France, June 27-July 3, 1996. Nashville, TN: Vanderbilt University Press. 279–292 (1997)
- [54] Q. Qu, J. Sun, and J. Wright, *Finding a sparse vector in a subspace: Linear sparsity using alternating directions*, IEEE Trans. Inform. Theory 62(10) (2016), 5855–5880.
- [55] M. Rudelson and R. Vershynin, *Sampling from large matrices: An approach through geometric functional analysis*, J. ACM 54 (4), (2007), Art. 21, 19 pp.

- [56] D. Silver, A. Huang, C. J. Maddison, A. Guez, L. Sifre, G. Van Den Driessche, J. Schrittwieser et al., *Mastering the game of Go with deep neural networks and tree search*, Nature 529, no. 7587 (2016), 484–489.
- [57] D. Soudry and Y. Carmon, *No bad local minima: Data independent training error guarantees for multilayer neural networks*, arXiv:1605.08361.
- [58] J. Stallkamp, M. Schlipsing, J. Salmen, and C. Igel, *Man vs. computer: Benchmarking machine learning algorithms for traffic sign recognition*, Neural Networks 32 (2012), 323–332.
- [59] C. Stein, *Estimation of the mean of a multivariate normal distribution*, Ann. Stat. 9 (1981), 1135–1151.
- [60] G. W. Stewart, *Perturbation theory for the singular value decomposition*, in SVD and Signal Processing, II, ed. R. J. Vacarro, Elsevier, 1991.
- [61] E. Robeva, *Orthogonal decomposition of symmetric tensors*, SIAM J. Matrix Anal. Appl. 37 (1) (2016), 86–102.
- [62] G. M. Rotskoff, E. Vanden-Eijnden, *Neural Networks as Interacting Particle Systems: Asymptotic Convexity of the Loss Landscape and Universal Scaling of the Approximation Error*, arXiv:1805.00915, 2018
- [63] I. Sturm, S. Lopuschkin, W. Samek, and K.-R. Müller, *Interpretable deep neural networks for single-trial EEG classification*, J. Neuroscience Methods 274 (2016), 141–145.
- [64] T. Tao, *Topics in random matrix theory*, Vol. 132, American Mathematical Soc., 2012.
- [65] J. Tropp, *User-friendly tail bounds for sums of random matrices*, Found. Comput. Math. 12 (4) (2012), 389–434.
- [66] P.-A. Wedin, *Perturbation bounds in connection with singular value decomposition*, BIT 12 (1972), 99–111.