

The Finite Difference Method, for the heat equation on Sierpiński simplices

Nizare Riane, Claire David*

March 16, 2022

Sorbonne Université

CNRS, UMR 7598, Laboratoire Jacques-Louis Lions, 4, place Jussieu 75005, Paris, France

Abstract

In the sequel, we extend our previous work on the Minkowski Curve to Sierpiński simplices (Gasket and Tetrahedron), in the case of the heat equation. First, we build the finite difference scheme. Then, we give a theoretical study of the error, compute the scheme error, give stability conditions, and prove the convergence of the scheme. Contrary to existing work, we do not call for approximations of the eigenvalues.

Keywords: Laplacian - Sierpiński simplices - Heat equation - Finite difference method - Courant Friedrichs Lewy (CFL) condition.

AMS Classification: 37F20- 28A80-05C63.

1 Introduction

Following the seminal work of J. Kigami [6], [7], [8], [9] in the field of analysis on fractals, the natural step was to explore the numerical related areas.

It has been initiated, in the case of the Sierpiński gasket, by K. Dalrymple, R. S. Strichartz, and J. Vinson [1], who gave an equivalent method for the finite difference approximation. More precisely, the authors use the spectral shape of the solution (heat kernel), which involves eigenvalues and eigenvectors, and therefore calls for an approximation of the eigenvalues. This work has been followed by the one of M. Gibbons, A. Raj and R. S. Strichartz [4], where they describe how one can build approximate solutions, by means of piecewise harmonic, or biharmonic, splines, again in the case of SG . They go so far as giving theoretical error estimates, through a comparison with experimental numerical data.

After our work [10], where we built a Laplacian on the Minkowski curve, we went so far as implementing the resulting finite difference scheme, for which one cannot find any equivalent in the existing literature.

The novelty of our contribution layed in defining the discretization of the considered PDE's (heat and wave equation), by taking into account the recursive construction of the matrix related to the

*Corresponding author: Claire.David@Sorbonne-Universite.fr

sequence of graph Laplacians. Contrary to the aforementioned work, we thus did not call for approximations of the eigenvalues. This enabled us not only to compute the consistency error, but, also, to set stability conditions of Courant-Friedrichs-Lewy type, and, then, to prove the convergence of the scheme.

In the sequel, we extend this method to Sierpiński simplices (Gasket and Tetrahedron), in the case of the heat equation. First, we build the finite difference scheme. Then, we give a theoretical study of the error, compute the scheme error, give stability conditions, and prove the convergence of the scheme.

2 The Sierpiński simplices

In the sequel, we place ourselves in the Euclidean space of dimension $d - 1$ for a strictly positive integer d , referred to a direct orthonormal frame. The usual Cartesian coordinates will be denoted by $(x_1, x_2, \dots, x_{d-1})$.

Let us introduce the family of contractions f_i , $1 \leq i \leq d$, of fixed point P_{i-1} such that, for any $X \in \mathbb{R}^{d-1}$, and any integer i belonging to $\{1, \dots, d\}$:

$$f_i(X) = \frac{1}{2}(X + P_{i-1})$$

According to [5], there exists a unique subset $\mathfrak{S}\mathfrak{S} \subset \mathbb{R}^{d-1}$ such that:

$$\mathfrak{S}\mathfrak{S} = \bigcup_{i=1}^d f_i(\mathfrak{S}\mathfrak{S})$$

which will be called the Sierpiński simplex.

We will denote by V_0 the ordered set, of the points:

$$\{P_0, \dots, P_{d-1}\}$$

The set of points V_0 , where, for any i of $\{0, \dots, d - 1\}$, every point P_i is linked to the others, constitutes an complete oriented graph, that we will denote by $\mathfrak{S}\mathfrak{S}_0$. V_0 is called the set of vertices of the graph $\mathfrak{S}\mathfrak{S}_0$.

For any strictly positive integer m , we set:

$$V_m = F(V_{m-1})$$

The set of points V_m , where the points of an m^{th} -order cell are linked in the same way as $\mathfrak{S}\mathfrak{S}_0$, is an oriented graph, which we will denote by $\mathfrak{S}\mathfrak{S}_m$. V_m is called the set of vertices of the graph $\mathfrak{S}\mathfrak{S}_m$. We will denote, in the following, by \mathcal{N}_m the number of vertices of the graph $\mathfrak{S}\mathfrak{S}_m$.

Proposition 2.1. *Given a natural integer m , we will denote by \mathcal{N}_m the number of vertices of the graph $\mathfrak{S}\mathfrak{S}_m$. One has:*

$$\mathcal{N}_0 = d$$

and, for any strictly positive integer m :

$$\mathcal{N}_m = d\mathcal{N}_{m-1} - \frac{d(d-1)}{2}$$

Proof. The graph $\mathfrak{S}\mathfrak{S}_m$ is the union of d copies of the graph $\mathfrak{S}\mathfrak{S}_{m-1}$. Each copy shares a vertex with the other ones. So, one may consider the copies as the vertices of a complete graph K_d , the number of edges is equal to $\frac{d(d-1)}{2}$, which leads to $\frac{d(d-1)}{2}$ vertices to take into account. \square

Remark 2.1. One may check that $\mathcal{N}_m = \frac{d^{m+1} + d}{2}$.

3 The finite difference method on the Minkowski curve

In the sequel, we will denote by T a strictly positive real number, by \mathcal{N}_0 the cardinal of V_0 , and by \mathcal{N}_m the cardinal of V_m .

3.1 The heat equation

3.1.1 Formulation of the problem

We may now consider a solution u of the problem:

$$\begin{cases} \frac{\partial u}{\partial t}(t, x) - \Delta u(t, x) &= 0 & \forall (t, x) \in]0, T[\times \mathfrak{S}\mathfrak{S} \\ u(t, x) &= 0 & \forall (x, t) \in \partial\mathfrak{S}\mathfrak{S} \times [0, T[\\ u(0, x) &= g(x) & \forall x \in \mathfrak{S}\mathfrak{S} \end{cases}$$

In order to define a numerical scheme, one may use a first order forward difference scheme to approximate the time derivative $\frac{\partial u}{\partial t}$. The Laplacian is approximated by means of the graph Laplacians $\Delta_m u$, defined on the sequence of graphs $(\mathfrak{S}\mathfrak{S}_m)_{m \in \mathbb{N}^*}$.

To this purpose, we fix a strictly positive integer N , and set:

$$h = \frac{T}{N}$$

One has, for any integer k belonging to $\{0, \dots, N-1\}$:

$$\forall X \in \mathfrak{S}\mathfrak{S} : \quad \frac{\partial u}{\partial t}(kh, x) = \frac{1}{h} (u((k+1)h, X) - u(kh, X)) + \mathcal{O}(h)$$

According to [13], the Laplacian on Sierpiński simplices $\mathfrak{S}\mathfrak{S}$ is given by:

$$\forall X \in \mathfrak{S}\mathfrak{S} : \quad \Delta u(t, X) = \lim_{m \rightarrow +\infty} r^{-m} \left(\int_{\mathfrak{S}\mathfrak{S}_m} \psi_{X_m}^{(m)} d\mu \right)^{-1} \left(\sum_{X_m \overset{m}{\sim} Y} u(t, Y) - u(t, X_m) \right)$$

where, for any naturel integer m , $X_m \in V_m \setminus V_0$, $\psi_{X_m}^{(m)}$ a piecewise harmonic function, and:

$$\lim_{m \rightarrow \infty} X_m = X$$

This enables one to approximate the Laplacian, at a m^{th} order, $m \in \mathbb{N}^*$, using the graph normalized Laplacian as follows:

$$\forall k \in \{0, \dots, N-1\}, \forall X \in \mathfrak{G}\mathfrak{G} : \quad \Delta u(t, X) \approx r^{-m} \left(\int_{\mathfrak{G}\mathfrak{G}} \psi_{X_m}^{(m)} d\mu \right)^{-1} \left(\sum_{X_m \sim Y} u(kh, Y) - u(kh, X_m) \right)$$

By combining those two relations, one gets the following scheme, for any integer k belonging to $\{0, \dots, N-1\}$, any point P_j of V_0 , $0 \leq j \leq N_0 - 1$, and any X in the set $V_m \setminus V_0$:

$$(\mathcal{S}_H) \quad \begin{cases} \frac{u_h^m((k+1)h, X) - u_h^m(kh, X)}{h} & = & r^{-m} \left(\int_{\mathfrak{G}\mathfrak{G}} \psi_{X_m}^{(m)} d\mu \right)^{-1} \left(\sum_{X_m \sim Y} u_h^m(kh, Y) - u_h^m(kh, X) \right) \\ u_h^m(kh, P_j) & = & 0 \\ u_h^m(0, X) & = & g(X) \end{cases}$$

Let us define the approximate equation as:

$$u_h^m((k+1)h, X) = u_h^m(kh, X) + h r^{-m} \left(\int_{\mathfrak{G}\mathfrak{G}} \psi_{X_m}^{(m)} d\mu \right)^{-1} \left(\sum_{X_m \sim Y} u_h^m(kh, Y) - u_h^m(kh, X) \right) \quad \forall k \in \{0, \dots, N-1\}$$

We now fix $m \in \mathbb{N}$, and denote any $X \in V_m \setminus V_0$ as X_{w, P_i} , where $w \in \{1, \dots, d\}^m$ is a word of length m , and where P_i , $0 \leq i \leq d-1$ belongs to V_0 . We also set:

$$n = \# \{w \in \{1, \dots, d\}^m\}$$

This enables one to introduce, for any integer k belonging to $\{0, \dots, N-1\}$, the solution vector $U(k)$ as:

$$U_h^m(k) = \begin{pmatrix} u_h^m(kh, X_1) \\ \vdots \\ u_h^m(kh, X_{N_m-d}) \end{pmatrix}$$

which satisfies the recurrence relation:

$$U_h^m(k+1) = A U_h^m(k)$$

where:

$$A = I_{N_m-d} - h \tilde{\Delta}_m$$

and where I_{N_m-d} denotes the $(N_m - d) \times (N_m - d)$ identity matrix, and $\tilde{\Delta}_m$ the $(N_m - d) \times (N_m - d)$ normalized Laplacian matrix.

3.1.2 Theoretical study of the error, for Hölder continuous functions

i. General case

In the spirit of the work of R. S. Strichartz [12], [14], it is interesting to consider the case of Hölder continuous functions. Why ? First, Hölder continuity implies continuity, which is a required condition for functions in the domain of the Laplacian (we refer to our work [10] for further details). Second, a Hölder condition for such a function will result in fruitful estimates for its Laplacian, which is a limit of difference quotients.

Let us thus consider a function u in the domain of the Laplacian, and a nonnegative real constant α such that:

$$\forall (X, Y) \in \mathfrak{G}\mathfrak{G}^2, \forall t > 0 : |u(t, X) - u(t, Y)| \leq C(t) |X - Y|^\alpha$$

where C denotes a positive function of the time variable t .

Given a strictly positive integer m , due to:

$$\Delta_m u(t, X) = \sum_{Y \in V_m, Y \sim_m X} (u(t, Y) - u(t, X)) \quad \forall t > 0, \forall X \in V_m \setminus V_0$$

Given a strictly positive integer m , its Laplacian is defined as the limit :

$$\Delta_\mu u(t, X) = \lim_{m \rightarrow +\infty} r^{-m} \left(\int_{\mathfrak{G}\mathfrak{G}} \psi_{X_m}^{(m)} d\mu \right)^{-1} \Delta_m u(t, X_m) \quad \forall t > 0, \forall X \in \mathfrak{G}\mathfrak{G}$$

where $(X_m \in V_m \setminus V_0)_{m \in \mathbb{N}}$ is a sequence a points such that:

$$\lim_{m \rightarrow +\infty} X_m = X$$

and where r denotes the normalization ratio, $\psi_{X_m}^{(m)}$ a harmonic spline function, and where:

$$\Delta_m u(t, X) = \sum_{Y \in V_m, Y \sim_m X} (u(t, Y) - u(t, X)) \quad \forall t > 0, \forall X \in V_m \setminus V_0$$

Let us now introduce a strictly positive number $\delta_{ij} := |P_i - P_j|$, for any P_i belonging to the set V_0 , and any P_j such that $P_j \sim P_i$. We set: $\delta_i = \max_j \delta_{ij}$.

In the other hand, define R to be the contraction ratio of the similarity f_i , and $R = \frac{1}{2}$.

One has then, for any X belonging to the set $V_m \setminus V_0$, any integer k belonging to $\{0, \dots, N - 1\}$, and any strictly positive number h :

$$\begin{aligned}
\left| r^{-m} \left(\int_{\mathfrak{S}\mathfrak{S}} \psi_{X_m}^{(m)} d\mu \right)^{-1} \right| h |\Delta_m u(kh, X)| &\leq \left| r^{-m} \left(\int_{\mathfrak{S}\mathfrak{S}} \psi_{X_m}^{(m)} d\mu \right)^{-1} \right| h \sum_{Y \in V_m, Y \sim_m X} |u(kh, Y) - u(kh, X)| \\
&\leq \left| r^{-m} \left(\int_{\mathfrak{S}\mathfrak{S}} \psi_{X_m}^{(m)} d\mu \right)^{-1} \right| h C(kh) \sum_{Y \in V_m, Y \sim_m X} |X - Y|^\alpha \\
&\leq \left| r^{-m} \left(\int_{\mathfrak{S}\mathfrak{S}} \psi_{X_m}^{(m)} d\mu \right)^{-1} \right| h C(kh) \sum_{m | Y \in V_m, Y \sim_m X} \delta^\alpha R^{m\alpha} \\
&\leq \left| r^{-m} \left(\int_{\mathfrak{S}\mathfrak{S}} \psi_{X_m}^{(m)} d\mu \right)^{-1} \right| h C(kh) \sum_{p=0}^{+\infty} \delta^\alpha R^{p\alpha} \\
&= \delta^\alpha \frac{\left| r^{-m} \left(\int_{\mathfrak{S}\mathfrak{S}} \psi_{X_m}^{(m)} d\mu \right)^{-1} \right| h C(kh)}{(1 - R^\alpha)}
\end{aligned}$$

We used the fact that, for $X \sim_m Y$, X and Y have addresses such that:

$$X = f_w(P_i) \quad , \quad Y = f_w(P_j)$$

for some P_i and P_j in V_0 and $w \in \{1, \dots, d\}^m$. May one set:

$$R(w) = R_{w_1} R_{w_2} \dots R_{w_m}$$

one gets:

$$|X - Y| = |f_w(P_i) - f_w(P_j)| = R(w) |P_i - P_j| \leq R^m \delta$$

The scheme (\mathcal{S}_H) allow us to write:

$$|u((k+1)h, X) - u(kh, X)| \leq \delta^\alpha \frac{\left| r^{-m} \left(\int_{\mathfrak{S}\mathfrak{S}} \psi_{X_m}^{(m)} d\mu \right)^{-1} \right| h C(kh)}{(1 - \frac{1}{2}^\alpha)}$$

One may note that a required condition for the convergence of the scheme is:

$$\lim_{m \rightarrow +\infty, h \rightarrow 0^+} \left| r^{-m} \left(\int_{\mathfrak{S}\mathfrak{S}} \psi_{X_m}^{(m)} d\mu \right)^{-1} \right| h C(kh) = 0$$

In the case where C is a constant function, it reduces to:

$$\lim_{m \rightarrow +\infty, h \rightarrow 0^+} \left| r^{-m} \left(\int_{\mathfrak{S}\mathfrak{S}} \psi_{X_m}^{(m)} d\mu \right)^{-1} \right| h = 0$$

3.1.3 Consistency, stability and convergence

3.1.3.1 The scheme error

Let us consider a continuous function u defined on $\mathfrak{S}\mathfrak{S}$. For all k in $\{0, \dots, N-1\}$:

$$\forall X \in \mathfrak{S}\mathfrak{S} : \quad \frac{\partial u}{\partial t}(kh, X) = \frac{1}{h} (u((k+1)h, X) - u(kh, X)) + \mathcal{O}(h)$$

In the other hand, given a strictly positive integer m , $X \in V_m \setminus V_0$, and a harmonic function $\psi_X^{(m)}$ on the m^{th} -order cell, taking the value 1 on X and 0 on the others vertices (see [12]):

$$\int_{\mathfrak{S}\mathfrak{S}} \psi_X^{(m)}(y) (\Delta u(X) - \Delta u(Y)) d\mu(Y) = \frac{2}{d} d^{-m} \Delta u(X) - \left(\frac{d+2}{d}\right)^m \Delta_m u(X)$$

Then:

$$\Delta u(X) - \frac{d}{2} (d+2)^m \Delta_m u(X) = \frac{d}{2} d^m \int_{\mathfrak{S}\mathfrak{S}} \psi_X^{(m)}(Y) (\Delta u(X) - \Delta u(Y)) d\mu(Y)$$

Let us now consider the case of Hölder continuous functions, as in the above:

$$\forall (X, Y) \in \mathfrak{S}\mathfrak{S}^2 : |u(X) - u(Y)| \leq C |X - Y|^\alpha$$

where C and α are nonnegative real constants.

Given a strictly positive integer m , due to:

$$\Delta_m u(X) = \sum_{Y \in V_m, Y \sim_m X} (u(Y) - u(X)) \quad \forall X \in V_m \setminus V_0$$

this yields:

$$|\Delta_m u(X)| \lesssim |Y - X|^\alpha \quad \forall X \in V_m \setminus V_0$$

and thus:

$$|\Delta u(X)| \lesssim |Y - X|^\alpha \quad \forall X \in \mathfrak{S}\mathfrak{S} \setminus V_0$$

One may note that:

$$\frac{d}{2} d^m \int_{\mathfrak{S}\mathfrak{S}} \psi_X^{(m)}(Y) (\Delta u(X) - \Delta u(Y)) d\mu(Y)$$

is the mean value of $\Delta u(X) - \Delta u(Y)$ over the m^{th} -order cell containing X , and Δu is a continuous function, so we can apply the mean value formula for integrals; there exists c_m in the m^{th} -order cell containing X such that :

$$\begin{aligned} \left| \Delta u(x) - \frac{d}{2} (d+2)^m \Delta_m u(X) \right| &= \Delta u(X) - \Delta u(c_m) \\ &\lesssim |X - c_m|^\alpha \\ &\lesssim \left(\frac{1}{2}\right)^{m\alpha} \end{aligned}$$

Finally:

$$\Delta u(x) = \frac{d}{2} (d+2)^m \Delta_m u(x) + \mathcal{O}(2^{-m\alpha})$$

3.1.3.2 Consistency

Definition 3.1. The scheme is said to be **consistent** if the consistency error go to zero when $h \rightarrow 0$ and $m \rightarrow +\infty$, for some norm.

The consistency error of our scheme is given by :

$$\varepsilon_{k,i}^m = \mathcal{O}(h) + \mathcal{O}(2^{-m\alpha}) \quad 0 \leq k \leq N-1, 1 \leq i \leq \mathcal{N}_m - d.$$

One may check that

$$\lim_{h \rightarrow 0, m \rightarrow +\infty} \varepsilon_{k,i}^m = 0$$

The scheme is then consistent.

3.1.3.3 Stability

Definition 3.2. Let us recall that the **spectral norm** ρ is defined as the induced norm of the norm $\|\cdot\|_2$. It is given, for a square matrix A , by:

$$\rho(A) = \sqrt{\lambda_{\max}(A^T A)}$$

where λ_{\max} stands for the spectral radius.

Proposition 3.1. *Let us denote by Φ the function such that:*

$$\forall x \neq 0 : \quad \Phi(x) = x(d+2-x).$$

According to [3], the eigenvalues λ_m , $m \in \mathbb{N}$, of the Laplacian are related recursively:

$$\forall m \geq 1 : \quad \lambda_{m-1} = \Phi(\lambda_m).$$

We deduce that, for any strictly positive integer m :

$$\lambda_m^\pm = \frac{(d+2) \pm \sqrt{(d+2)^2 - 4\lambda_{m-1}}}{2}$$

Let us introduce the functions ϕ^- and ϕ^+ such that, for any x in $\left] -\infty, \frac{(d+2)^2}{4} \right]$:

$$\phi^-(x) = \frac{(d+2) - \sqrt{(d+2)^2 - 4x}}{2}, \quad \phi^+(x) = \frac{(d+2) + \sqrt{(d+2)^2 - 4x}}{2}$$

$$\phi^+(0) = d+2, \quad \phi^-\left(\frac{(d+2)^2}{4}\right) = \frac{d+2}{2}, \quad \phi^-(0) = 0, \quad \text{and} \quad \phi^+\left(\frac{(d+2)^2}{4}\right) = \frac{d+2}{2}.$$

The function ϕ^- is increasing. Its fixed point is $x^{-,*} = 0$.

The function ϕ^+ is non increasing. Its fixed point is $x^{+,*} = (d+2) - 1$.

One may also check that the following two maps are contractions, since:

$$\left| \frac{d}{dx} \phi^-(0) \right| = \frac{1}{\sqrt{(d+2)^2}} = \frac{1}{d+2} < 1$$

and:

$$\left| \frac{d}{dx} \phi^+ ((d+2) - 1) \right| = \frac{1}{\sqrt{(d+2)^2 - 4(d+2) + 4}} = \frac{1}{d} < 1.$$

In [11], T. Shima shows that the Laplacien on V_1 has Dirichlet eigenvalues $d+2$ with multiplicity $d-1$, and 2 with multiplicity 1, and gives the complete spectrum for $m \geq 1$.

The complete Dirichlet spectrum, for $m \geq 2$, is generated by the recurrent stable maps (convergent towards the fixed points) ϕ^+ and ϕ^- with initial values 2, $d+2$ and $2d$.

One may finally conclude that, for any natural integer m :

$$0 \leq \lambda_m \leq 2d$$

Definition 3.3. The scheme is said to be:

- unconditionally stable if there exist a constant $C < 1$ independent of h and m such that:

$$\rho(A^k) \leq C \quad \forall k \in \{1, \dots, N\}$$

- conditionally stable if there exist three constants $\alpha > 0$, $C_1 > 0$ and $C_2 < 1$ such that:

$$h \leq C_1 ((d+2)^{-m})^\alpha \implies \rho(A^k) \leq C_2 \quad \forall k \in \{1, \dots, N\}$$

Proposition 3.2. Let us denote by γ_i , $i = 1, \dots, \mathcal{N}_m - d$, the eigenvalues of the matrix A . Then:

$$\forall i = 1, \dots, \mathcal{N}_m - d : \quad h(d+2)^m \leq \frac{2}{d^2} \implies |\gamma_i| \leq 1.$$

Proof. Let us recall our scheme writes, for any integer k belonging to $\{1, \dots, N\}$:

$$(\mathcal{S}_{\mathcal{H}}) \quad \left\{ \begin{array}{l} \frac{u_h^m((k+1)h, X_i) - u_h^m(kh, X_i)}{h} = \frac{d}{2}(d+2)^m \sum_{X_i \sim Y} (u_h^m(kh, Y) - u_h^m(kh, X_i)) \quad \forall 1 \leq i \leq \mathcal{N}_m - d \\ u_h^m(kh, P_j) = 0 \\ u_h^m(0, X_i) = g(X_i) \quad 1 \leq i \leq \mathcal{N}_m - d \end{array} \right.$$

i.e., under matrix form:

$$U_h^m(k) = \begin{pmatrix} u_h^m(kh, X_1) \\ \vdots \\ u_h^m(kh, X_{\mathcal{N}_m-d}) \end{pmatrix} \quad \forall k \in \{1, \dots, N\}.$$

It satisfies the recurrence relation:

$$U_h^m(k+1) = A U_h^m(k) \quad \forall k \in \{1, \dots, N\}$$

where:

$$A = I_{\mathcal{N}_m - d} - h \tilde{\Delta}_m.$$

One may use the recurrence to find:

$$U_h^m(k) = A^k U_h^m(0) \quad \forall k \in \{1, \dots, N\}.$$

The eigenvalues γ_i , $i = 1, \dots, \mathcal{N}_m - d$, of A are such that:

$$\gamma_i = 1 - h \left(\frac{d}{2} (d+2)^m \right) \lambda_i$$

One has, for any integer i belonging to $\{1, \dots, \mathcal{N}_m - d\}$:

$$1 - h \frac{d}{2} (d+2)^m (2d) \leq \gamma_i \leq 1$$

which leads to:

$$h (d+2)^m \leq \frac{2}{d^2} \implies |\gamma_i| \leq 1.$$

□

3.1.3.4 Convergence

Definition 3.4.

- The scheme is said to be convergent for the matrix norm $\|\cdot\|$ if :

$$\lim_{h \rightarrow 0, m \rightarrow +\infty} \left\| (u(kh, X_i) - u_h^m(kh, X_i))_{0 \leq k \leq N, 1 \leq i \leq \mathcal{N}_m} \right\| = 0$$

- The scheme is said to be conditionally convergent for the matrix norm $\|\cdot\|$ if there exist two real constants α and C such that :

$$\lim_{h \leq C((d+2)^{-m})^\alpha, m \rightarrow +\infty} \left\| (u(kh, X_i) - u_h^m(kh, X_i))_{0 \leq k \leq N, 1 \leq i \leq \mathcal{N}_m} \right\| = 0$$

Theorem 3.3. *If the scheme is stable and consistent, then it is also convergent for the norm $\|\cdot\|_{2,\infty}$, such that:*

$$\left\| (u_h^m(kh, X_i))_{0 \leq k \leq N, x \in V_m \setminus V_0} \right\|_{2,\infty} = \max_{0 \leq k \leq N} \left(d^{-m} \sum_{1 \leq i \leq \mathcal{N}_m} |u_h^m(kh, X_i)|^2 \right)^{\frac{1}{2}}$$

Proof. Let us set:

$$w_i^k = u(kh, X_i) - u_h^m(kh, X_i), \quad 0 \leq k \leq N, 1 \leq i \leq \mathcal{N}_m.$$

One may check that:

$$\begin{aligned} w_{\mathcal{N}_m-d+1}^k = \dots = w_{\mathcal{N}_m}^k &= 0 & 0 \leq k \leq N \\ w_i^0 &= 0 & 1 \leq i \leq \mathcal{N}_m - d \end{aligned}$$

Let us now introduce, for any integer k belonging to $\{0, \dots, N\}$:

$$W^k = \begin{pmatrix} w_1^k \\ \vdots \\ w_{\mathcal{N}_m-d}^k \end{pmatrix}, \quad E^k = \begin{pmatrix} \varepsilon_{k,1}^m \\ \vdots \\ \varepsilon_{k,\mathcal{N}_m-d}^m \end{pmatrix}$$

One has then $W^0 = 0$, and, for any integer k belonging to $\{1, \dots, N-1\}$:

$$W^{k+1} = A W^k + h E^k$$

One finds recursively, for any integer k belonging to $\{0, \dots, N-1\}$:

$$W^{k+1} = A^k W^0 + h \sum_{j=0}^{k-1} A^j E^{k-j-1} = h \sum_{j=0}^{k-1} A^j E^{k-j-1}$$

Since the matrix A is a symmetric one, the **CFL** stability condition $h(d+2)^m \leq \frac{2}{d^2}$ yields, for any integer k belonging to $\{0, \dots, N\}$:

$$\begin{aligned} |W^k| &\leq h \left(\sum_{j=0}^{k-1} \|A\|^j \right) \left(\max_{0 \leq k \leq j-1} |E^k| \right) \\ &\leq h k \left(\max_{0 \leq k \leq j-1} |E^k| \right) \\ &\leq h N \left(\max_{0 \leq k \leq j-1} |E^k| \right) \\ &\leq T \left(\max_{0 \leq k \leq j-1} \left(\sum_{i=1}^{\mathcal{N}_m-d} |\varepsilon_{k,i}^m|^2 \right)^{\frac{1}{2}} \right) \end{aligned}$$

One deduces then:

$$\begin{aligned} \max_{0 \leq k \leq N} \left(d^{-m} \sum_{i=1}^{\mathcal{N}_m-d} |w_i^k|^2 \right)^{\frac{1}{2}} &= d^{-\frac{m}{2}} \max_{1 \leq k \leq N} |W^k| \\ &\leq \left(d^{-\frac{m}{2}} \right) T \left(\max_{0 \leq k \leq N-1} \left(\sum_{i=1}^{\mathcal{N}_m-d} |\varepsilon_{k,i}^m|^2 \right)^{\frac{1}{2}} \right) \\ &\leq \left(d^{-\frac{m}{2}} \right) T \left((\mathcal{N}_m - d)^{\frac{1}{2}} \max_{0 \leq k \leq N-1, 1 \leq i \leq \mathcal{N}_m-d} |\varepsilon_{k,i}^m| \right) \\ &= \sqrt{\left(d^{-m} \frac{d^{m+1} - d}{2} \right)} T \left(\max_{0 \leq k \leq N-1, 1 \leq i \leq \mathcal{N}_m-d} |\varepsilon_{k,i}^m| \right) \\ &= \mathcal{O}(h) + \mathcal{O}(2^{-m\alpha}) \\ &= \mathcal{O}((d+2)^{-m}) + \mathcal{O}(2^{-m\alpha}) \\ &= \mathcal{O}(2^{-m\alpha}). \end{aligned}$$

The scheme is thus convergent. \square

Remark 3.1. One has to bear in mind that, for piecewise constant functions u on the m^{th} -order cells:

$$\|(u_h^m(kh, X_i))\|_2 = \left(d^{-m} \sum_{1 \leq i \leq \mathcal{N}_m} |u_h^m(kh, X_i)|^2 \right)^{\frac{1}{2}} = \|(u_h^m(kh, X_i))\|_{L^2(\mathfrak{S}\mathfrak{S})}.$$

3.1.4 The specific case of the implicit Euler Method

Let us consider the implicit Euler scheme, for any integer k belonging to $\{0, \dots, N-1\}$, any point P_j of V_0 , $0 \leq j \leq N_0 - 1$, and any X in the set $V_m \setminus V_0$:

$$(\mathcal{S}_H) \quad \begin{cases} \frac{u_h^m(kh, X) - u_h^m((k-1)h, X)}{h} & = r^{-m} \left(\int_{\mathfrak{S}\mathfrak{S}} \psi_{X_m}^{(m)} d\mu \right)^{-1} \left(\sum_{\substack{X \sim Y \\ m}} u_h^m(kh, Y) - u_h^m(kh, X) \right) \\ u_h^m(kh, P_j) & = 0 \\ u_h^m(0, X) & = g(X) \end{cases}$$

Let us define the approximate equation as:

$$u_h^m(kh, X) - h \times r^{-m} \left(\int_{\mathfrak{S}\mathfrak{S}} \psi_{X_m}^{(m)} d\mu \right)^{-1} \left(\sum_{\substack{X \sim Y \\ m}} u_h^m(kh, Y) - u_h^m(kh, X) \right) = u_h^m((k-1)h, X) \quad \forall k \in \{0, \dots, N-1\}$$

As before, we fix $m \in \mathbb{N}$, and denote any $X \in V_m \setminus V_0$ as X_{w, P_i} , where $w \in \{1, \dots, d\}^m$ denotes a word of length m , and where P_i , $0 \leq i \leq d-1$ belongs to V_0 . Let us also set:

$$n = \#\{w \in \{1, \dots, N\}^m\}$$

We get, for any integer k belonging to $\{0, \dots, N-1\}$, the solution vector $U(k)$ as before:

$$U_h^m(k) = \begin{pmatrix} u_h^m(kh, X_1) \\ \vdots \\ u_h^m(kh, X_{\mathcal{N}_m-d}) \end{pmatrix}$$

It satisfies the recurrence relation:

$$\tilde{A} U_h^m(k) = U_h^m(k-1)$$

where:

$$\tilde{A} = I_{\mathcal{N}_m-d} + h \times \tilde{\Delta}_m$$

and where $I_{\mathcal{N}_m-d}$ denotes the $(\mathcal{N}_m - d) \times (\mathcal{N}_m - d)$ identity matrix, and $\tilde{\Delta}_m$ the $(\mathcal{N}_m - d) \times (\mathcal{N}_m - d)$ normalized Laplacian matrix.

3.1.4.1 Consistency, stability and convergence

i. The scheme error Let u a function defined on \mathfrak{SS} . For all k in $\{0, \dots, N-1\}$:

$$\forall X \in \mathfrak{SS} : \frac{\partial u}{\partial t}(kh, X) = \frac{1}{h} (u(kh, X) - u((k-1)h, X)) + \mathcal{O}(h)$$

In the other hand, for $X \in V_m \setminus V_0$:

$$\Delta u(x) = \frac{d}{2}(d+2)^m \Delta_m u(x) + \mathcal{O}(2^{-m\alpha})$$

ii. Consistency The consistency error of the implicit Euler scheme is given by :

$$\varepsilon_{k,i}^m = \mathcal{O}(h) + \mathcal{O}(2^{-m\alpha}) \quad 0 \leq k \leq N-1, 1 \leq i \leq \mathcal{N}_m - d$$

We can check that

$$\lim_{h \rightarrow 0, m \rightarrow \infty} \varepsilon_{k,i}^m = 0$$

The scheme is then consistent.

3.1.4.2 Stability

Definition 3.5. The scheme is said to be :

- unconditionally stable for the norm $\| \cdot \|_\infty$ if there exist a constant $C > 0$ independent of h and m such that :

$$\| U_h^m(k) \|_\infty \leq C \| U_h^m(0) \|_\infty \quad \forall k \in \{1, \dots, N\}$$

- conditionally stable if there exist three constants $\alpha > 0$, $C_1 > 0$ and $C_2 < 1$ such that :

$$h \leq C_1 ((d+2)^{-m})^\alpha \implies \| U_h^m(k) \|_\infty \leq C_2 \| U_h^m(0) \|_\infty \quad \forall k \in \{1, \dots, N\}$$

Let us recall that our scheme writes:

$$(\mathcal{S}_h) \begin{cases} \frac{u_h^m(kh, X_i) - u_h^m((k-1)h, X_i)}{h} & = & \frac{d}{2}(d+2)^m \left(\sum_{X_i \sim_m^Y} u_h^m(kh, Y) - u_h^m(kh, X_i) \right) & \forall 1 \leq k \leq N, 1 \leq i \leq \mathcal{N}_m - d \\ u_h^m(kh, P_j) & = & 0 & \forall 1 \leq k \leq N \\ u_h^m(0, X_i) & = & g(X_i) & 1 \leq i \leq \mathcal{N}_m - d \end{cases}$$

i.e., under matrix form :

$$U_h^m(k) = \begin{pmatrix} u_h^m(kh, X_1) \\ \vdots \\ u_h^m(kh, X_{\mathcal{N}_m-d}) \end{pmatrix}$$

which satisfies the recurrence relation:

$$\tilde{A} U_h^m(k) = U_h^m(k-1)$$

where :

$$\tilde{A} = I_{\mathcal{N}_m-d} + h \times \tilde{\Delta}_m$$

One has:

$$\|\tilde{A}^{-1}\|_{\infty} \leq 1 \quad \text{and thus} \quad \|\tilde{A}^{-n}\|_{\infty} \leq 1$$

This enables us to conclude that the scheme is unconditionally stable :

$$U_h^m(k) \leq U_h^m(0)$$

iii. Convergence

Theorem 3.4. *The implicit Euler scheme is convergent for the norm $\|\cdot\|_{2,\infty}$.*

Proof. Let:

$$w_i^k = u(kh, X_i) - u_m^h(kh, X_i), \quad 0 \leq k \leq N, \quad 1 \leq i \leq \mathcal{N}_m$$

One may check that:

$$\begin{aligned} w_{\mathcal{N}_m-d+1}^k &= \dots = w_{\mathcal{N}_m}^k = 0 & 0 \leq k \leq N \\ w_i^0 &= 0 & 1 \leq i \leq \mathcal{N}_m - d \end{aligned}$$

We set:

$$W^k = \begin{pmatrix} w_1^k \\ \vdots \\ w_{\mathcal{N}_m-d}^k \end{pmatrix}, \quad E^k = \begin{pmatrix} \varepsilon_{k,1}^m \\ \vdots \\ \varepsilon_{k,\mathcal{N}_m-d}^m \end{pmatrix}$$

Thus, $W^0 = 0$, and, for $0 \leq k \leq N-1$:

$$W^{k+1} = \tilde{A}^{-1}W^k + hE^k \quad 0 \leq k \leq N-1$$

We find, by induction, for $0 \leq k \leq N-1$:

$$\begin{aligned} W^{k+1} &= \tilde{A}^{-k}W^0 + h \sum_{j=0}^{k-1} \tilde{A}^{-j}E^{k-j-1} \\ &= h \sum_{j=0}^{k-1} \tilde{A}^{-j}E^{k-j-1} \end{aligned}$$

Due to the stability of the scheme, we have, for $k = 0, \dots, N$:

$$\begin{aligned} |W^k| &\leq h \left(\sum_{j=0}^{k-1} \|\tilde{A}^{-1}\|^j \right) \left(\max_{0 \leq k \leq j-1} |E^k| \right) \\ &\leq h k \left(\max_{0 \leq k \leq j-1} |E^k| \right) \\ &\leq h N \left(\max_{0 \leq k \leq j-1} |E^k| \right) \\ &\leq T \left(\max_{0 \leq k \leq j-1} \left(\sum_{i=1}^{\mathcal{N}_m-d} |\varepsilon_{k,i}^m|^2 \right)^{1/2} \right) \end{aligned}$$

One deduces then:

$$\begin{aligned}
\max_{0 \leq k \leq N} \left(d^{-m} \sum_{i=1}^{\mathcal{N}_m-d} |w_i^k|^2 \right)^{\frac{1}{2}} &= (d)^{-\frac{m}{2}} \max_{1 \leq k \leq N} |W^k| \\
&\leq \left(d^{-\frac{m}{2}} \right) T \left(\max_{0 \leq k \leq N-1} \left(\sum_{i=1}^{\mathcal{N}_m-d} |\varepsilon_{k,i}^m|^2 \right)^{1/2} \right) \\
&\leq \left(d^{-\frac{m}{2}} \right) T \left((\mathcal{N}_m - d)^{\frac{1}{2}} \max_{0 \leq k \leq N-1, 1 \leq i \leq \mathcal{N}_m-d} |\varepsilon_{k,i}^m| \right) \\
&= \sqrt{\left(d^{-m} \frac{d^{m+1} - d}{2} \right)} T \left(\max_{0 \leq k \leq N-1, 1 \leq i \leq \mathcal{N}_m-d} |\varepsilon_{k,i}^m| \right) \\
&= (\mathcal{O}(h) + \mathcal{O}(2^{-m\alpha}))
\end{aligned}$$

The scheme is thus convergent. □

3.1.5 Numerical results - Gasket and Tetrahedron

3.1.5.1 Recursive construction of the matrix related to the sequence of graph Laplacians

In the sequel, we describe our recursive algorithm used to construct matrix related to the sequence of graph Laplacians, in the case of Sierpiński Gasket and Tetrahedron.

i. The Sierpiński Gasket.

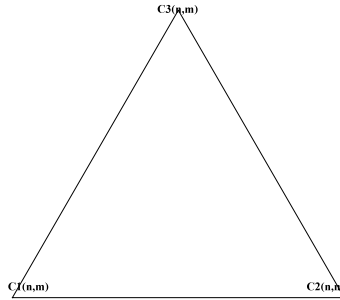

Figure 1 – m^{th} -order cell of the Sierpiński Gasket.

One may note, first, that, given a strictly positive integer m , a m^{th} -order triangle has three corners, that we will denote by $C1$, $C2$ and $C3$; the $(m+1)^{th}$ -order triangle is then constructed by connecting three m copies $T(n)$ with $n = 1, 2, 3$.

The initial triangle is labeled such that $C1 \sim 1$, $C2 \sim 2$ and $C3 \sim 3$ (see figure 1).

The fusion is done by connecting $C2(1, m) \sim C1(2, m)$, $C3(1, m) \sim C1(3, m)$, and $C3(2, m) \sim C2(3, m)$ (see figures 2, 3, 4).

The label of the corner vertex can be obtained by means of the following recursive sequence, for any strictly positive integer m :

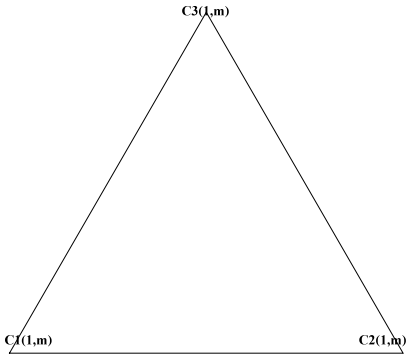

Figure 2 – The first copy $T(1)$

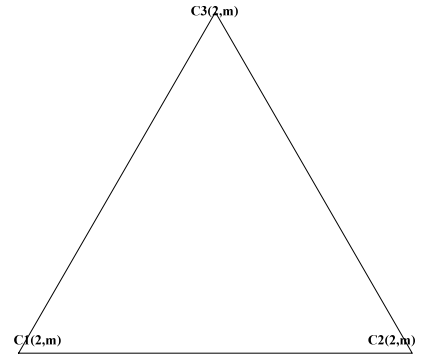

Figure 3 – The second copy $T(2)$

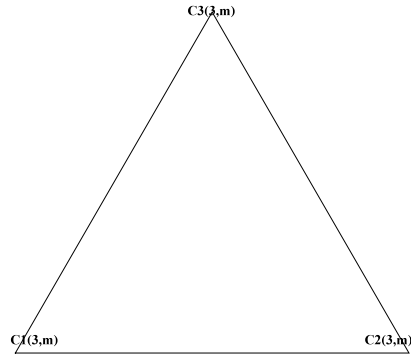

Figure 4 – The third copy $T(3)$

$$\begin{aligned}
 C1(n, m) &= 1 + (n - 1) \mathcal{N}_{m-1} \\
 C2(n, m) &= I2(m) + (n - 1) \mathcal{N}_{m-1} \\
 C3(n, m) &= n \mathcal{N}_{m-1}
 \end{aligned}$$

where:

$$\begin{aligned}
 \mathcal{N}_{-1} &= 3 \quad , \quad I2(0) = 0 \\
 I2(m) &= I2(m - 1) + \mathcal{N}_{m-2} - 1.
 \end{aligned}$$

1. One may start with the initial triangle with the set of vertices V_0 . The corresponding matrix is given by:

$$A_0 = \begin{pmatrix} 2 & -1 & -1 \\ -1 & 2 & -1 \\ -1 & -1 & 2 \end{pmatrix}$$

2. If $m = 0$, the Laplacian matrix is A_0 , else, A_m is constructed recursively from three copies of the Laplacian matrices A_{m-1} of the graph V_{m-1} . First, we build, for any strictly positive integer m , the block diagonal matrix:

$$B_m = \begin{pmatrix} A_{m-1} & 0 & 0 \\ 0 & A_{m-1} & 0 \\ 0 & 0 & A_{m-1} \end{pmatrix}$$

3. One may then introduce, for any strictly positive integer m , the connection matrix as in [2]:

$$C_m = \begin{pmatrix} C2(1, m) & C3(1, m) & C3(2, m) \\ C1(2, m) & C1(3, m) & C2(3, m) \end{pmatrix}$$

4. One has then to sum the rows (resp. the columns) $C_m(2, j)$ and $C_m(1, j)$, and delete the row and the column $C_m(2, j)$.

ii. The Sierpiński Tetrahedron.

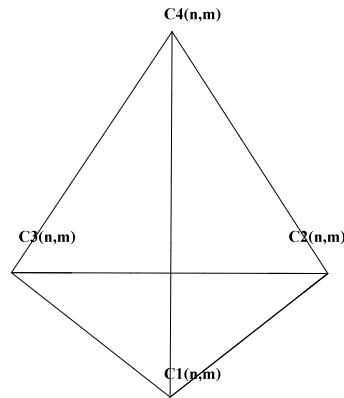

Figure 5 – m^{th} -order cell of the Sierpiński Tetrahedron.

One may note, first, that, given a strictly positive integer m , a m^{th} -order tetrahedron has four corners $C1$, $C2$, $C3$ and $C4$ (see figure 5), and that the $(m + 1)^{th}$ -order triangle is constructed by connecting four m copies $T(n)$, with $n = 1, 2, 3, 4$ (see figure 6, 7, 8, 9).

As in the case of the triangle, the initial tetrahedron is labeled such that $C1 \sim 1$, $C2 \sim 2$, $C3 \sim 3$ and $C4 \sim 4$.

The fusion is done by connecting $C2(1, m) \sim C1(2, m)$, $C3(1, m) \sim C1(3, m)$, $C4(1, m) \sim C1(4, m)$, $C3(2, m) \sim C2(3, m)$, $C4(2, m) \sim C2(4, m)$, $C4(3, m) \sim C3(4, m)$.

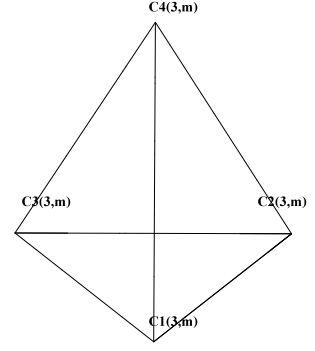
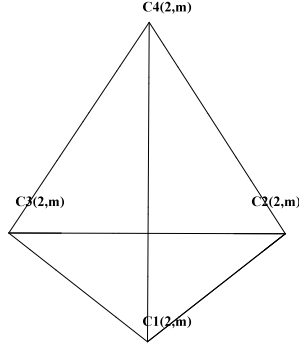
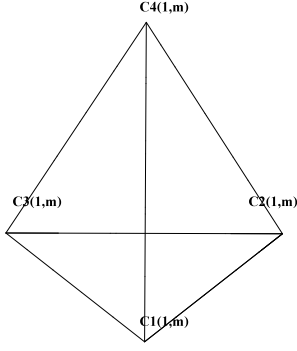

Figure 6 – The first copy $T(1)$. Figure 7 – The second copy $T(2)$. Figure 8 – The third copy $T(3)$.

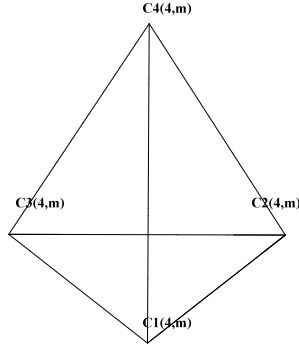

Figure 9 – The fourth copy $T(4)$.

The number of corners can be obtained by means of the following recursive sequence, for any strictly positive integer m :

$$\begin{aligned}
 C1(n, m) &= 1 + (n - 1) \mathcal{N}_{m-1} \\
 C2(n, m) &= I2(m) + (n - 1) \mathcal{N}_{m-1} \\
 C3(n, m) &= I3(m) + (n - 1) \mathcal{N}_{m-1} \\
 C4(n, m) &= n \mathcal{N}_{m-1}
 \end{aligned}$$

where:

$$\begin{aligned}
 \mathcal{N}_{-1} &= 3 \\
 I2(0) &= 0 \\
 I2(m) &= I2(m - 1) + \mathcal{N}_{m-2} - 1 \\
 I3(1) &= 3 \\
 I3(m) &= I3(m - 1) + 2 \times \mathcal{N}_{m-2} - 3
 \end{aligned}$$

1. One starts with initial tetrahedron with the set of vertices V_0 . The corresponding matrix is given by:

$$A_0 = \begin{pmatrix} 3 & -1 & -1 & -1 \\ -1 & 3 & -1 & -1 \\ -1 & -1 & 3 & -1 \\ -1 & -1 & -1 & 3 \end{pmatrix}$$

2. If $m = 0$ the Laplacian matrix is A_0 , else, for any strictly positive integer m , A_m is constructed recursively from three copies of the Laplacian matrices A_{m-1} of the graph V_{m-1} . Thus, we build the block diagonal matrix:

$$B_m = \begin{pmatrix} A_{m-1} & 0 & 0 & 0 \\ 0 & A_{m-1} & 0 & 0 \\ 0 & 0 & A_{m-1} & 0 \\ 0 & 0 & 0 & A_{m-1} \end{pmatrix}$$

3. We then write the connection matrix:

$$C_m = \begin{pmatrix} C2(1, m) & C3(1, m) & C3(2, m) & C4(1, m) & C4(2, m) & C4(3, m) \\ C1(2, m) & C1(3, m) & C2(3, m) & C1(4, m) & C2(4, m) & C3(4, m) \end{pmatrix}$$

4. One then has to sum the rows (resp. the columns) $C_m(2, j)$ to $C_m(1, j)$, and delete the row and the column $C_m(2, j)$.

3.1.5.2 Numerical results

i. The Sierpiński Gasket

In the sequel (see figures 10 to 14), we present the numerical results for $m = 6$, $T = 1$ and $N = 2 \times 10^5$.

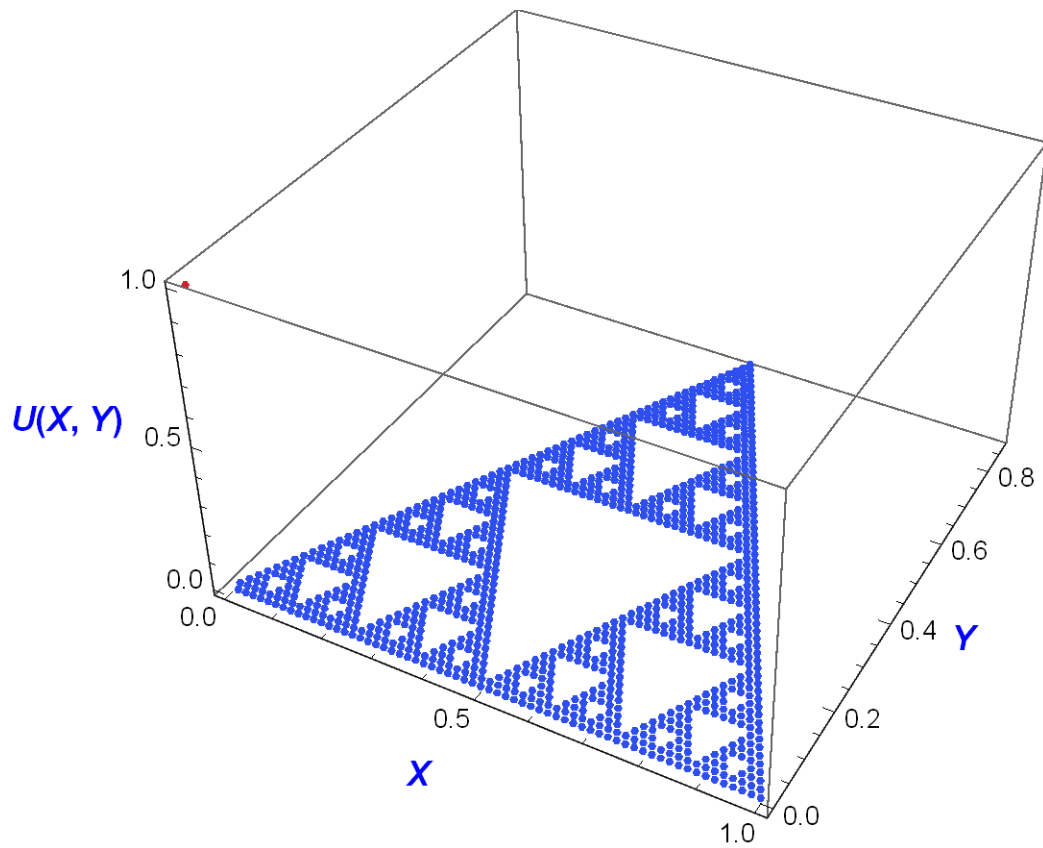

Figure 10 – The graph of the approached solution of the heat equation for $k = 0$.

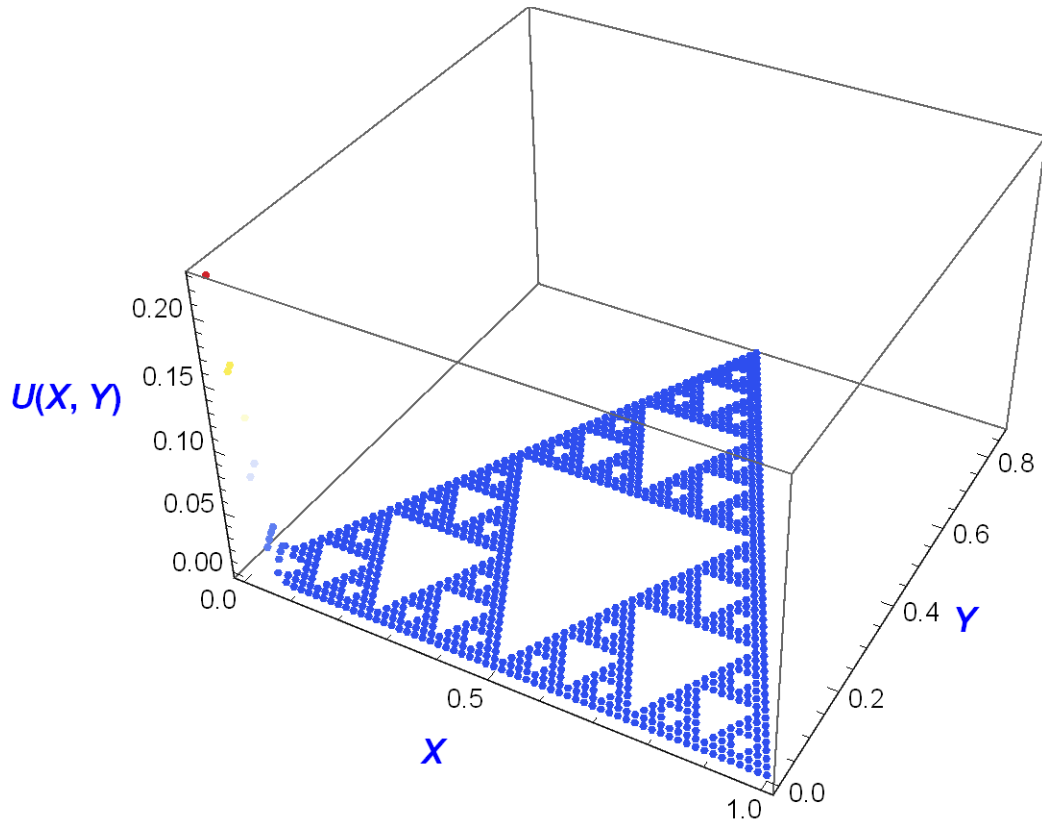

Figure 11 – The graph of the approached solution of the heat equation for $k = 10$.

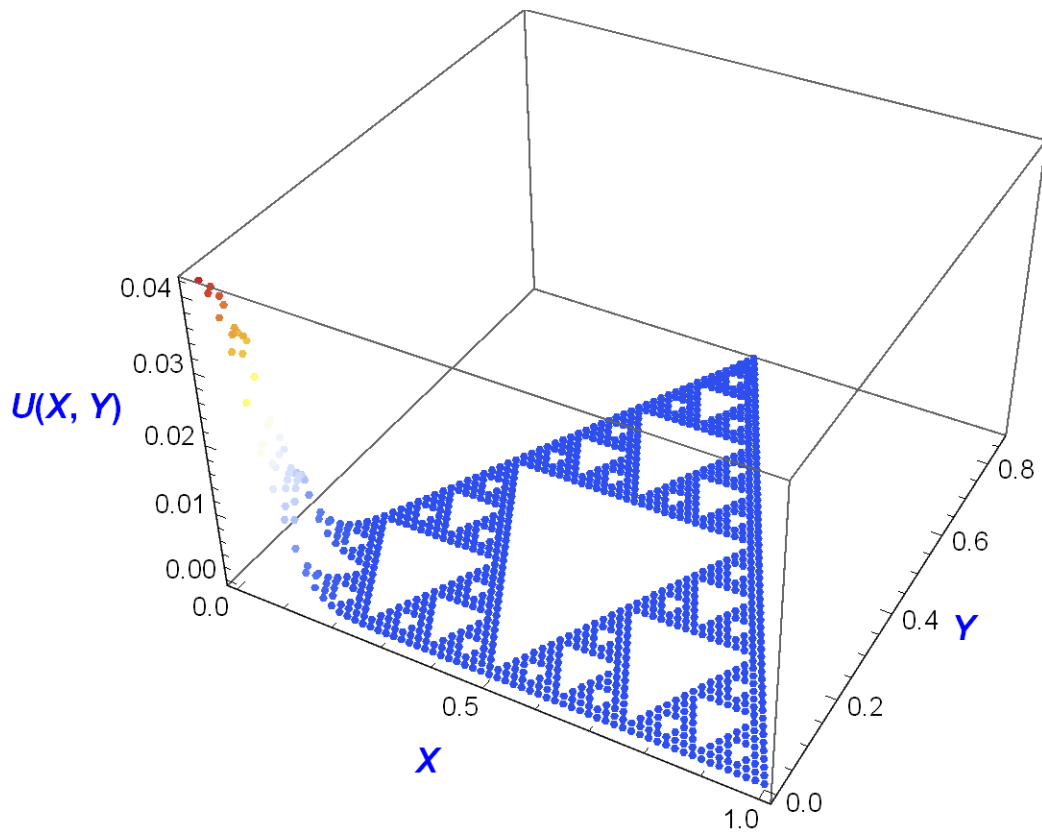

Figure 12 – The graph of the approached solution of the heat equation for $k = 100$.

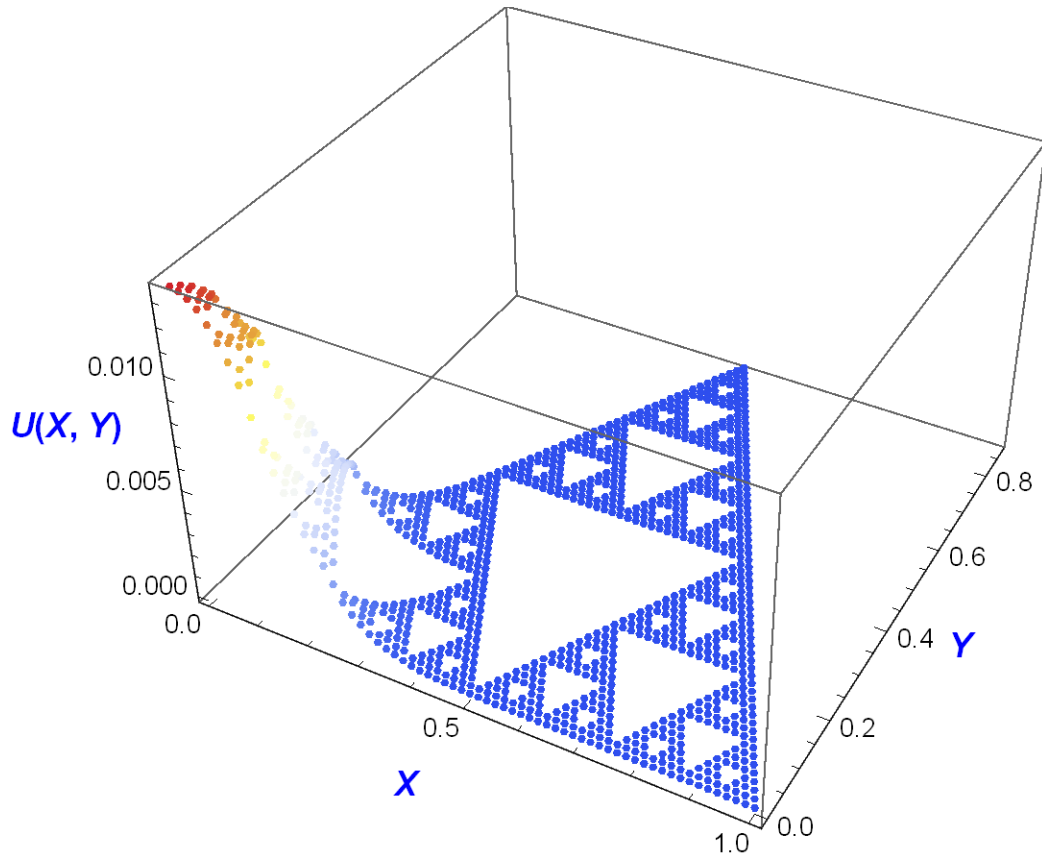

Figure 13 – The graph of the approached solution of the heat equation for $k = 500$.

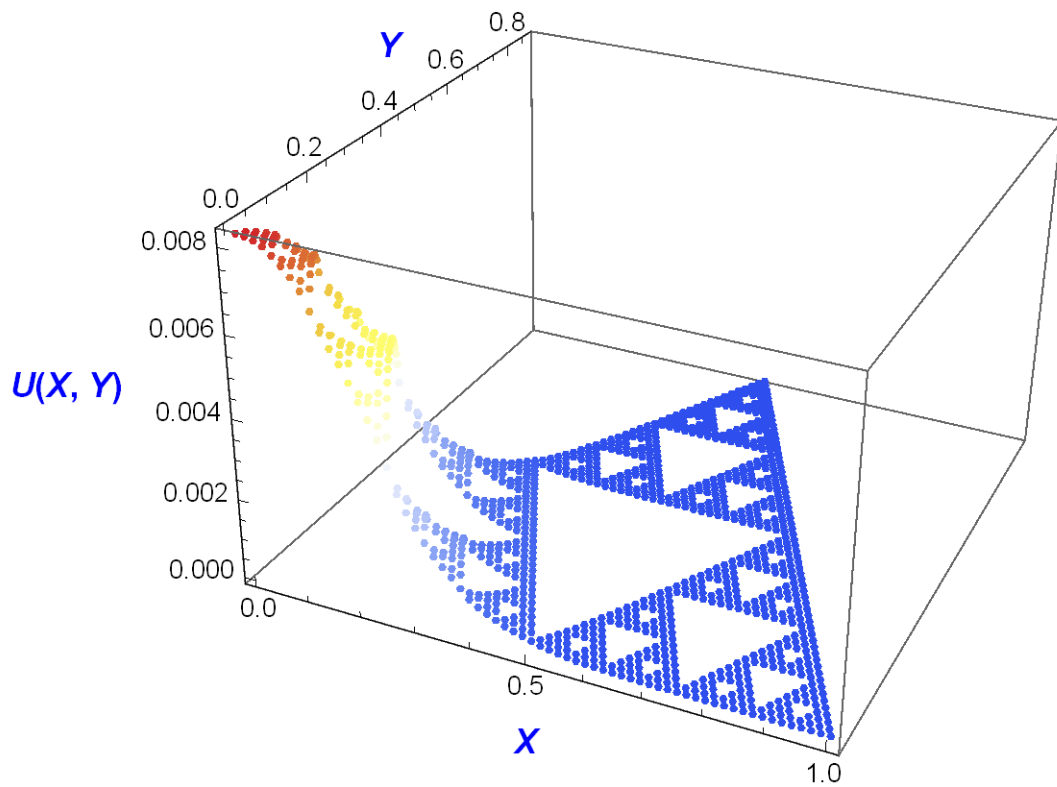

Figure 14 – The graph of the approached solution of the heat equation for $k = 1000$.

ii. The Sierpiński Tetrahedron

In the sequel (see figures 15 to 19), we present the numerical results for $m = 5$, $T = 1$ and $N = 10^5$.

Our heat transfer simulation consists in a propagation scenario, where the initial condition is a harmonic spline g , the support of which being a m -cell, such that it takes the value 1 on a vertex x , and 0 otherwise.

The color function is related to the gradient of temperature, high values ranging from red to blue.

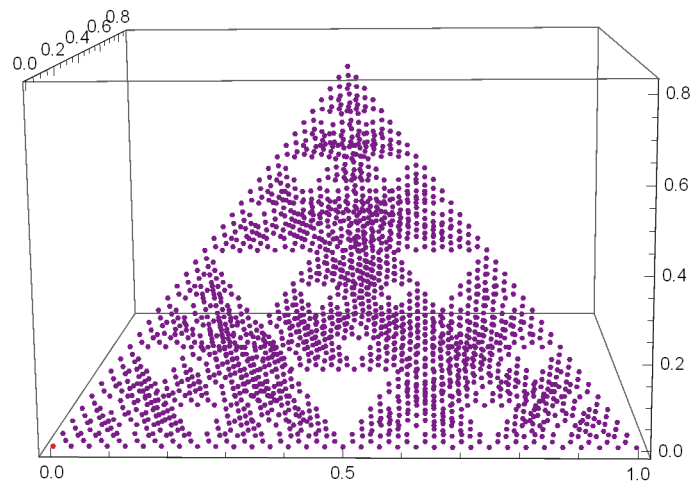

Figure 15 – The graph of the approached solution of the heat equation for $k = 0$.

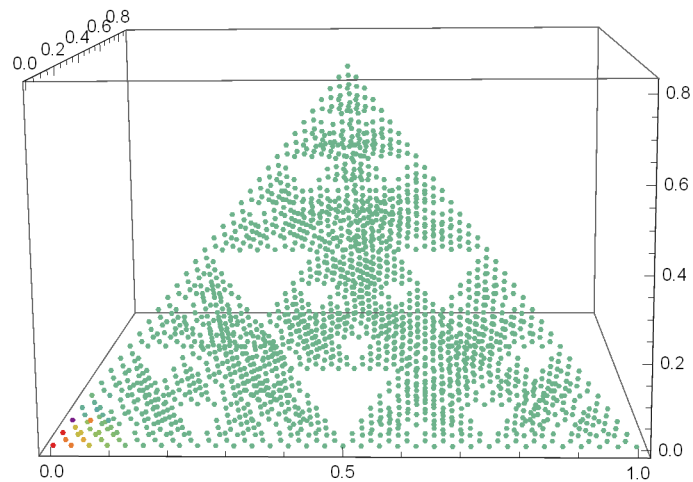

Figure 16 – The graph of the approached solution of the heat equation for $k = 10$.

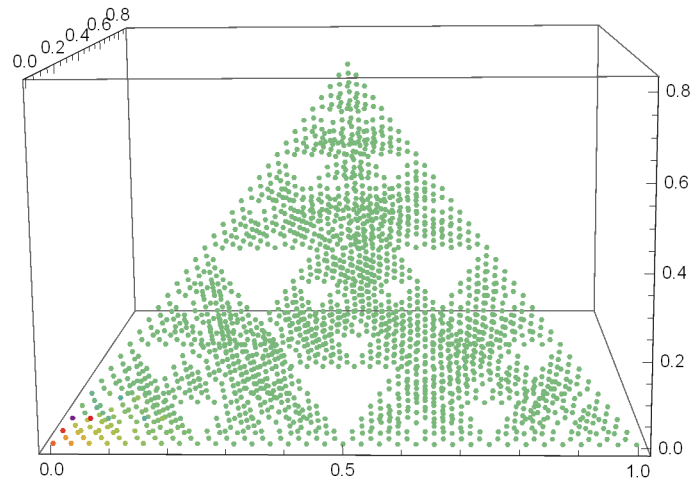

Figure 17 – The graph of the approached solution of the heat equation for $k = 50$.

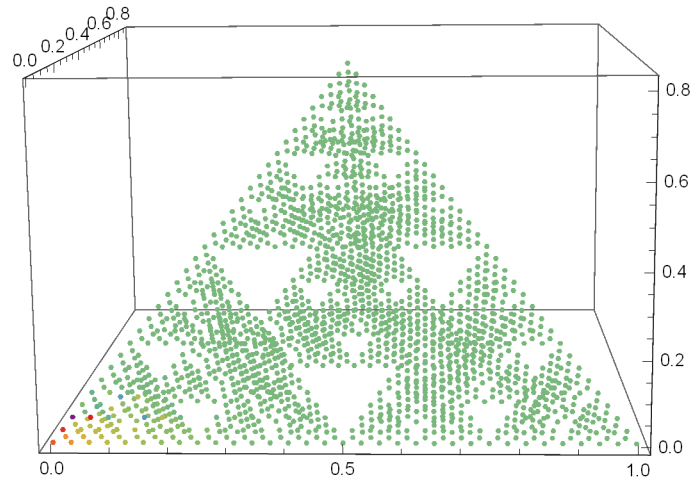

Figure 18 – The graph of the approached solution of the heat equation for $k = 100$.

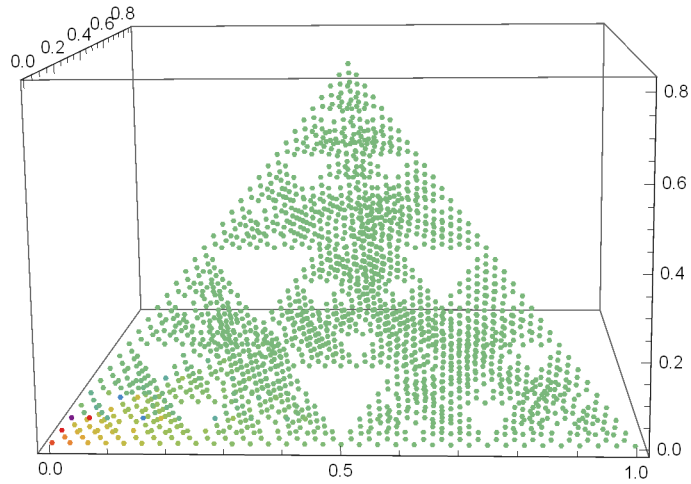

Figure 19 – The graph of the approached solution of the heat equation for $k = 500$.

An interesting feature in our work is that, contrary to existing ones, we do not rely on heat kernel estimates. Using a direct method has thus enabled us to discuss the choices of parameters as the integer m , the step h , and the convergence.

As expected, the numerical scheme is unstable and diverges until one respects the stability condition between h and m . Also, the propagation process evolves with time, directed from hot regions, towards cold ones.

In order to go further, we have also studied the evolution in time of the temperature of a point x_0 . Figures 20 and 21 respectively display the graph and log-log graph of the temperature as a function of time.

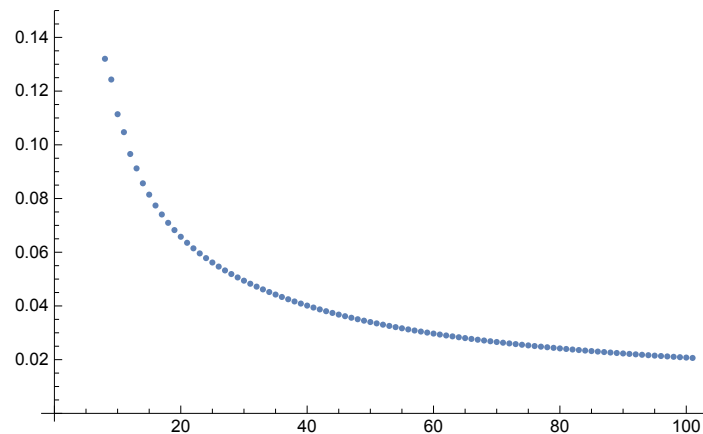

Figure 20 – The graph of the temperature as a function of time.

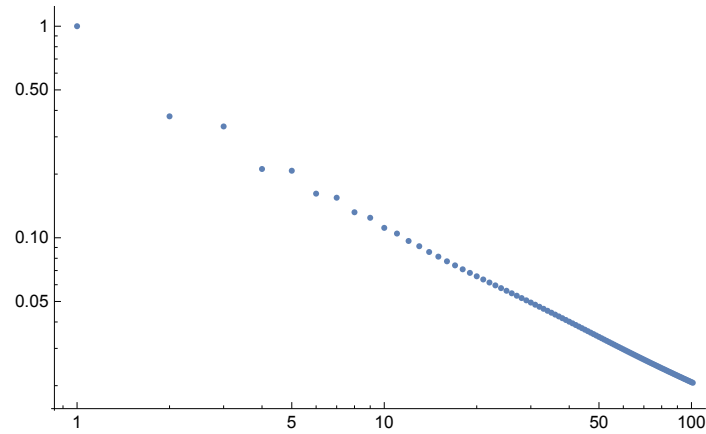

Figure 21 – The log-log graph of the temperature as a function of time.

We find, numerically that the temperature follows the law :

$$\ln(u(t, x_0)) \approx -1.01275 - 1.44972 \ln t$$

It is interesting to note that the slope is close of the spectral dimension $d_S = \frac{\ln 3}{\ln 2}$, which yields a power law of the form:

$$u(t, x_0) \approx C t^{d_S}$$

where C is a strictly positive real constant. This results holds for different values of m .

Such a result suggests that the spectral dimension belongs to the spectrum of the Laplacian, which is in accordance with theoretical results (see section 3, and [3]).

References

- [1] K. Dalrymple, R. S. Strichartz, and J. P. Vinson, *Fractal differential equations on the Sierpiński Gasket*, J. Fourier Anal. and Appl. **5** (1999), no. 2/3, 203–284.
- [2] U. R. Freiberg and M. R. Lancia, *Energy form on a closed fractal curve*, Analysis (Berlin) **23** (2004), no. 1, 115–137.
- [3] M. Fukushima and T. Shima, *On a spectral analysis for the Sierpiński gasket*, Potential Anal. **1** (1992), 1–3.
- [4] M. Gibbons, A. Raj, and R. S. Strichartz, *The Finite Element Method on the Sierpiński gasket*, Constr. Approx. **17** (2001), no. 4, 561–588.
- [5] J. E. Hutchinson, *Fractals and self similarity*, Indiana Univ. Math. J. **30** (1981), 713–747.
- [6] J. Kigami, *A harmonic calculus on the Sierpiński spaces*, Japan J. Appl. Math. **8** (1989), 259–290.
- [7] ———, *Harmonic calculus on p.c.f. self-similar sets*, Trans. Amer. Math. Soc. **335** (1993), 721–755.
- [8] ———, *Analysis on fractals*, Cambridge University Press, 2001.
- [9] ———, *Harmonic Analysis for Resistance Forms*, Japan J. Appl. Math. **204** (2003), 399–444.
- [10] N. Riane and Cl. David, *A spectral study of the Minkowski Curve*, hal-01527996, 2017.

- [11] T. Shima, *On eigenvalue problems for the random walks on the Sierpiński pre-gasket*, Japan J. Indus. Appl. Math. **8** (1991), 127–141.
- [12] R. S. Strichartz, *Analysis on fractals*, Notices Amer. Math. Soc. **46** (1999), no. 8, 1199–1208.
- [13] ———, *Differential equations on fractals, a tutorial*, Princeton University Press, 2006.
- [14] ———, *Taylor approximations on Sierpiński Gasket Type Fractals*, J. Func. Anal. **174** (2012), 76–127.