

Imposing jump conditions on nonconforming interfaces via least squares minimization

Alexandre Noll Marques^a, Jean-Christophe Nave^b, Rodolfo Ruben Rosales^c

^a*Department of Aeronautics and Astronautics, Massachusetts Institute of Technology
Cambridge, MA 02139-4307*

^b*Department of Mathematics and Statistics, McGill University
Montreal, Quebec H3A 0B9, Canada*

^c*Department of Mathematics, Massachusetts Institute of Technology
Cambridge, MA 02139-4307*

Abstract

We introduce a method to impose jump conditions on interfaces that are not aligned with a computational grid. In particular, we discuss this method in the context of solving the Poisson equation with a discontinuous solution using the *Correction Function Method* (CFM). The CFM offers a general framework to solve the Poisson equation in the presence of discontinuities to high order of accuracy, while using a compact discretization stencil. A key concept behind the CFM is enforcing the jump conditions in a least squares sense. This approach requires computing integrals over pieces of the interface, which becomes challenging when only an implicit representation of the interface is available (e.g., the zero contour of a level set function), especially in 3-D. The technique introduced here is based on a new least squares procedure that depends only on integrals over sections of the interface that are amenable to numerical quadrature after appropriate coordinate transformations. We incorporate this technique into a fourth order accurate implementation of the CFM, and show examples of solutions to the Poisson equation computed in 2-D and 3-D.

Keywords: Correction Function Method, Embedded interface, Poisson equation, High accuracy, Gradient-Augmented Level Set Method

PACS: 47.11-j, 47.11.Bc

2010 MSC: 76M20, 35N06

1. Introduction

Solving the Poisson equation in the presence of discontinuities is of great importance in many applications of science and engineering. In many cases, the discontinuities are caused by interfaces between different media, such as in multiphase flows, the Stefan problem, Janus drops, and other multiphase phenomena. These interfaces are themselves solutions to differential equations, and can assume complex configurations. For this reason, it is convenient to embed the interface into a regular triangulation or Cartesian grid and solve the Poisson equation in this regular domain. The Correction Function Method (CFM) [1–3] was developed to solve the Poisson equation in this context, and achieve high order of accuracy with a compact discretization stencil.

One of the key concepts behind the CFM is enforcing the jump conditions in a least squares sense. Although this concept is partly responsible for the robustness of the CFM (as explained in §2), it poses a challenge for implementing previous versions of the CFM in 3-D. Namely, the least squares procedure requires evaluating integrals over pieces of the interface, which is especially difficult in 3-D if only an implicit representation of the interface is available (e.g., the zero contour of a level set function). In this paper we address this challenge by introducing a new technique for imposing the jump conditions in a least squares sense. In this technique, the interface is split into small sections that are amenable to numerical quadrature after appropriate coordinate transformations. The jump conditions are then applied to each section individually, and their effects are combined in a least squares sense. This technique can be seamlessly applied in 2-D and 3-D. Moreover, throughout this paper we assume that an explicit representation of the interface is not available.

The general Poisson equation with discontinuous solution is given by

$$\nabla \cdot (\beta(\vec{x})\nabla u(\vec{x})) = f(\vec{x}) \quad \text{for } \vec{x} \in \Omega, \quad (1a)$$

$$[u(\vec{x})] = a(\vec{x}) \quad \text{for } \vec{x} \in \Gamma, \quad (1b)$$

$$[\beta(\vec{x})u_n(\vec{x})] = b(\vec{x}) \quad \text{for } \vec{x} \in \Gamma, \quad (1c)$$

$$u(\vec{x}) = g(\vec{x}) \quad \text{for } \vec{x} \in \partial\Omega. \quad (1d)$$

Here the solution domain Ω is split into two sub-domains, Ω_1 and Ω_2 , by a co-dimension 1 surface, Γ , disjoint from the boundary $\partial\Omega$. This situation is illustrated in figure 1. Furthermore, a and b are known functions defined on

Γ . Finally, the brackets denote the jump in the enclosed quantity across Γ , i.e.,

$$[u(\vec{x})] = \lim_{\substack{\vec{x}^* \rightarrow \vec{x} \\ \vec{x}^* \in \Omega_2}} u(\vec{x}^*) - \lim_{\substack{\vec{x}^* \rightarrow \vec{x} \\ \vec{x}^* \in \Omega_1}} u(\vec{x}^*). \quad (2)$$

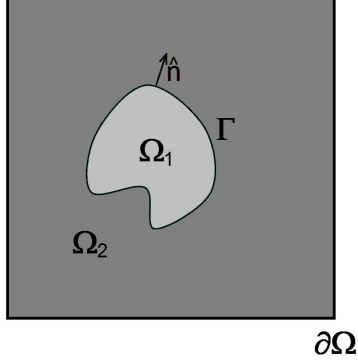

Figure 1: Illustration of the solution domain for the discontinuous Poisson equation. The domain Ω is split into two subdomains, Ω_1 and Ω_2 , by the internal interface Γ .

In general, β is a known positive function that can also be discontinuous across the interface Γ . However, in this paper we only consider the case where β is constant. As mentioned above, the focus of this paper is on how to impose the jump conditions in a least squares sense when only an implicit representation of the interface is available. The case of discontinuous β introduces additional difficulties that are not related to the focus of this paper. We addressed some of these difficulties in ref. [3] by coupling the CFM with boundary integral equations. However, solving boundary integral equations to high order of accuracy using level set functions is also a challenge. For this reason, we will introduce a more general framework for the case of discontinuous β in a paper that is currently in preparation [4].

Moreover, in this paper we assume that the domain boundary $\partial\Omega$ is perfectly aligned with the computational grid, such that the Dirichlet boundary condition in (1d) can be easily replaced by others, such as Neumann, Robin, or mixed. Our concern here is on how to deal with the jump conditions at the interface Γ .

Over the past four decades, several methods have been developed to solve (1), and other closely related problems, with either an interface or a

boundary that is embedded into a regular triangulation or Cartesian grid [5–34]. One of the shortcomings of many embedded methods is that they are rather hard to generalize beyond first or second order of accuracy. However, there are methods that achieve accuracy higher than second order, and they are based on one of the following ideas: (i) discretization stencils that incorporate the jump (or boundary) conditions [16–18, 23, 24], or (ii) smooth extrapolations of the solution constrained by the jump (or boundary) conditions [14, 28–30]. In practice these ideas are implemented by Taylor expansion or a similar concept, and high order of accuracy is obtained at the expense of wide discretization stencils. In turn, wide stencils introduce additional issues, such as handling multiple crossings of the interface by a single stencil, and restrictions on the proximity between interfaces. The method introduced by Mayo and collaborators [16–18] avoids wide discretization stencils by incorporating second and third derivatives of the jump conditions into the Taylor expansion. On the other hand, computing higher derivatives of the jump conditions requires the solution of an additional boundary integral equation.

In contrast to using Taylor expansion, the CFM [1–3] is based on computing a smooth extension of the solution by solving a partial differential equation that is compatible with the underlying Poisson problem. This concept results in a general framework that, in principle, can achieve arbitrary order of accuracy, and maintains compact discretization stencils. In ref. [1] we introduced the fundamentals of the CFM, and proposed a fourth order implementation to solve (1) in 2-D when β is constant. In ref. [3] we extended the CFM to solve (1) with piece-wise constant β , including the possibility of arbitrarily large jumps in the equation’s coefficients (in [3] we showed third order convergence for coefficient ratios of $O(10^6)$). The work of ref. [3] is inspired by Mayo’s method [16, 17], and also requires the solution of a boundary integral equation. However, there is an extension of the CFM for the case of discontinuous β that does not require the solution of a boundary integral equation. This extension is briefly discussed in ref. [2], and is the subject of a paper that is in preparation [4]. The CFM has also been extended to other classes of differential equations, such as the heat equation [2], the Navier-Stokes equations [2], and the wave equation [35]. An overview of the CFM for the Poisson equation is presented in §2.

One of the key features of the CFM is the fact that it enforces the jump conditions (1b–c) in a least squares sense. This feature, combined with an

appropriate representation of the solution, is responsible for the robustness¹ of the method with respect to the arbitrary fashion an interface can cross a regular computational grid. However, this feature requires accurate computations of surface integrals over pieces of the interface. These computations are particularly challenging in 3-D when the interface is represented by the zero contour of a level set function approximated on a regular grid.

In this paper we present a new technique to impose the jump conditions in a least squares sense. The new approach only requires the computation of integrals over (small) sections of the interface. It is based on the combination of (i) splitting the interface into small sections, (ii) defining local coordinate transformations that map these sections into squares, and (iii) an efficient scheme to compute the transformations between the local and the global coordinates. Furthermore, this technique can be applied to the CFM with only small modifications to the original CFM formulation. The result is a method to solve (1) that achieves high order of accuracy, uses compact discretization stencils, and can be implemented efficiently when the interface is represented by a level set function, both in 2-D and 3-D. The details are discussed in §3.

This paper is organized as follows. In §2 we present an overview of the CFM for the Poisson equation and the features relevant to the new formulation. Next, in §3 we present the details of the new technique for imposing the jump conditions in a least squares sense, including its effects on the CFM formulation. In §4 we present solutions computed with the modified CFM in 2-D and 3-D. Finally, the conclusions are in §5.

2. Overview of the Correction Function Method

The Correction Function Method (CFM) was developed to solve the Poisson equation (1) when the solution is discontinuous across an interface that is not aligned with a computational grid [1–3]. The CFM offers a general framework to produce discretizations of this problem to high order of accuracy. For instance, in ref. [1] we show a fourth order implementation of the CFM in 2-D for the problem where β is constant. In ref. [3] we show a third order implementation of the CFM, also in 2-D, for the problem where β is

¹By robustness we mean that no special cases need to be considered. Also, the CFM is robust because there are no restrictions on the proximity between interfaces. In §4 we show examples in which interfaces touch each other.

piece-wise constant. In this paper we focus on the implementation of the CFM in 3-D when then interface is represented by the zero contour of a level set function approximated on a regular grid. For the sake of simplicity, we restrict our presentation to the case where β is constant.

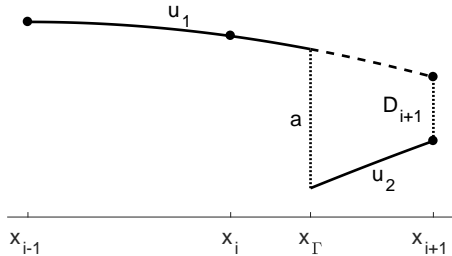

Figure 2: Illustration of how the correction function is used to complete discretization stencils. To compute u_{xx_i} , write $u_{1_{i+1}} = u_{2_{i+1}} - D_{i+1}$, which leads to (4).

The CFM is based on the notion of smooth extensions of the solution (denoted by u_1 and u_2) across the interface, and the definition of the *correction function*: $D = u_2 - u_1$. This function can be used to complete the discretization stencils that stride the interface. To illustrate this point, consider the approximate computation of u_{xx} at grid node i using standard centered finite differences:

$$u_{xx_i} \approx \frac{u_{i-1} - 2u_i + u_{i+1}}{h^2}, \quad (3)$$

where h is a uniform grid spacing. Equation (3) is known to produce errors $O(h^2)$ if $u \in C^2((x_{i-1}, x_{i+1}))$. However, when u is discontinuous, as depicted in figure 2, the approximation in (3) is not valid since it is based on Taylor expansions. One way to address this issue, originally introduced in the Ghost Fluid Method [25–27], is to estimate a smooth extension of the solution across the interface before applying the discretization. In practice, only the difference between the smooth extension and the actual grid values are needed. In the case depicted in figure 2, an estimate of $D_{i+1} = u_{2_{i+1}} - u_{1_{i+1}}$ can be used to correct (3) as follows:

$$u_{xx_i} \approx \frac{u_{i-1} - 2u_i + u_{i+1}}{h^2} - \frac{D_{i+1}}{h^2}. \quad (4)$$

To achieve high order of accuracy, the correction D needs to be computed to at least the same order as the one by the discretization of the underlying

Poisson equation. Other methods use Taylor expansions to estimate D [26, 27] or, equivalently, smooth extrapolations of u [25, 28–30]. In contrast, the CFM [1] computes D by solving a partial differential equation defined on a narrow band of width $O(h)$ that surrounds the interface. As shown in ref. [1], when β is constant, the correction function is defined as the solution to the following equation,

$$\nabla^2 D(\vec{x}) = (f_2(\vec{x}) - f_1(\vec{x}))/\beta = f_D(\vec{x}) \quad \text{for } \vec{x} \in \Omega_\Gamma, \quad (5a)$$

$$D(\vec{x}) = a(\vec{x}) \quad \text{for } \vec{x} \in \Gamma, \quad (5b)$$

$$D_n(\vec{x}) = b(\vec{x}) \quad \text{for } \vec{x} \in \Gamma, \quad (5c)$$

where Ω_Γ denotes the narrow band around the interface in which the correction function is defined.

Remark 1. Equation (5) is an elliptic Cauchy problem. In a continuous setting, this problem is ill-posed because small perturbations to the interface conditions (5b-c) result in arbitrarily large changes in the solution. However, in a numerical setting, where disturbances to (5b-c) are restricted to a finite wave length, it is possible to develop well-behaved numerical schemes to solve this problem in a narrow band surrounding the interface. The least squares approach used in the CFM (discussed below) is one such numerical scheme. In ref. [1] we explain the implications of using this method in terms of conditioning. ♣

In practice, it is convenient to solve (5) locally whenever the stencil used to discretize the Laplace operator in (1a) crosses the interface. Namely, (5) is solved in small patches Ω_{Γ_i} , $i \in S_\Gamma$, where S_Γ denotes the set of all grid nodes that are part of a stencil that crosses the interface. These patches are constructed using the “node-centered” approach [1] described next.

The construction of a patch Ω_{Γ_i} is illustrated in figure 3(a). Let \vec{x}_i denote the location of the grid node $i \in S_\Gamma$, and let ℓ_d denote a characteristic length of the discretization stencil. Then, the center of the patch Ω_{Γ_i} , denoted by \vec{x}_0 , is defined by an approximate projection of \vec{x}_i onto the interface:

$$\vec{x}_0 = \vec{x}_i - \phi(\vec{x}_i) \left(\frac{\vec{\nabla} \phi(\vec{x}_i)}{|\vec{\nabla} \phi(\vec{x}_i)|^2} \right), \quad (6)$$

where ϕ is the level set function used to represent the interface. Furthermore, the patch is oriented such that the plane tangent to the interface at

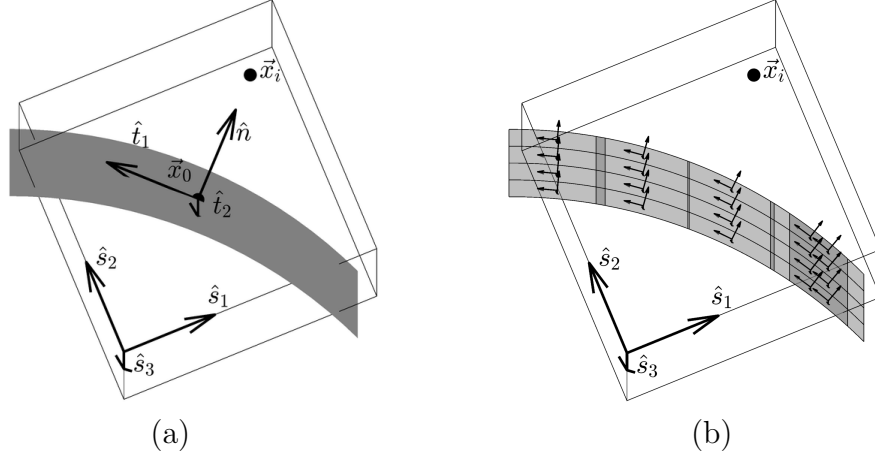

Figure 3: (a) Patch used to define the *correction function* in 3-D. (b) The interface integrals are evaluated over quasi-flat sections of the interface. The sections may overlap, and one patch may contain several sections.

\vec{x}_0 coincides with one of the diagonals of the patch. Algorithm 1 summarizes the computation of \vec{x}_0 , and the triad of unit vectors $\{\hat{s}_d\}_{d=1,2,3}$ that define the orientation of the patch. Finally, Ω_{Γ_i} is the cubic region of edge length ℓ_d that is centered at \vec{x}_0 and aligned with $\{\hat{s}_d\}$.

Algorithm 1 Patch to solve for the correction function near the node \vec{x}_i .

- 1: $\phi_i \leftarrow \phi(\vec{x}_i)$,
 $\vec{\nabla}\phi_i \leftarrow \vec{\nabla}\phi(\vec{x}_i)$
 - 2: $\vec{x}_0 \leftarrow \vec{x}_i - \phi_i \vec{\nabla}\phi_i / |\vec{\nabla}\phi_i|^2$,
 $\vec{\nabla}\phi_0 \leftarrow \vec{\nabla}\phi(\vec{x}_0)$
 - 3: $\hat{n} \leftarrow \vec{\nabla}\phi_0 / |\vec{\nabla}\phi_0|$
 - 4: $[\hat{t}_1, \hat{t}_2] \leftarrow \text{ORTHOGONAL}(\hat{n})$ ▷ see algorithm 2
 - 5: $\hat{s}_1 \leftarrow (\hat{n} - \hat{t}_1) / \sqrt{2}$
 - 6: $\hat{s}_2 \leftarrow \hat{t}_2 \times \hat{s}_1$
 - 7: $\hat{s}_3 \leftarrow \hat{t}_2$
-

The correction function is computed within each patch Ω_{Γ_i} by solving (5) in a least squares sense. This approach makes the solution robust with respect to the arbitrary fashion the interface can cross the computational

Algorithm 2 Basis vectors for the space orthogonal to \hat{n} . Based on ref. [27].

1: **function** ORTHOGONAL(\hat{n})
2: Determine \hat{e}_{\min} such that $\hat{n} \cdot \hat{e}_{\min} = \min(n_1, n_2, n_3)$
3: $\hat{t}_1 \leftarrow \hat{n} \times \hat{e}_{\min}$
4: $\hat{t}_2 \leftarrow \hat{n} \times \hat{t}_1$
5: **return** $[\hat{t}_1, \hat{t}_2]$
6: **end function**

grid. Specifically, the CFM formulation introduced in ref. [1] is based on solving (5) by minimizing the following functional,

$$J_i = \frac{\ell_d^4}{V_i} \int_{\Omega_{\Gamma_i}} (\nabla^2 D - f_D)^2 dV + \frac{c_P}{S_i} \int_{\Gamma \cap \Omega_{\Gamma_i}} [(D - a)^2 + \ell_d^2 (D_n - b)^2] dS, \quad (7)$$

where $V_i = \ell_d^3$ is the volume of the patch Ω_{Γ_i} , S_i is the area of the piece of interface contained within the patch, and c_P is a penalization coefficient used to enforce the jump conditions. Note that it is not necessary for the second integral in (7) to be exactly over the intersection of the interface with the patch, which is hard to compute in 3-D. This integral just needs to be over a piece of the interface which is approximately equal to the intersection. Relaxing this constraint is essential to the technique discussed in §3. In §3 we also discuss how to modify J_i to incorporate the interface integrals computed with the new technique.

The accuracy of the CFM stems from the fact that the correction function is defined as the solution to a PDE, which, in principle, can be solved to arbitrary order of accuracy. In the method described above, the accuracy is determined by the choice of basis functions used to represent D within each patch. In this paper, as in ref. [1], we obtain fourth order of accuracy by representing D with Hermite cubic interpolants.

Once the correction function D is known, it can be used to complete the discretization stencil whenever it straddles the interface, as illustrated by (4). Furthermore, because the correction function depends only on known parameters of the problem (a , b , f , and the position of Γ), the CFM produces modifications to the right-hand-side of the discretized equations only. As a result, one can solve the Poisson equation by inverting the exact same linear

system as in problems with no interface, but with a modified right-hand-side.

In addition, note that the PDE that defines the correction function, and the least squares procedure used to solve it, do not depend on the computational grid. Hence, the CFM is applied in exactly the same way for every discretization stencil that crosses the interface, and no special cases need to be considered. This feature makes the CFM very robust with respect to the arbitrary fashion an interface can cross the computational grid.

On the other hand, the least squares approach introduces the challenge of computing the surface integrals in (7) accurately. In ref. [1] the CFM is implemented in 2-D only, where the interfaces are 1-D curves. In this context, the level set information (specifically those provided by the Gradient-Augment Level Set Method of [36]) is used to create local parametrizations of these curves within each patch. Once these parametrizations are known, the surface integrals become simple to evaluate. However for 3-D problems, finding surface parametrizations based on level set information is significantly more challenging. In the next section we present an alternative approach to evaluate the surface integrals, suitable to both 2-D and 3-D implementations.

3. Imposing jump conditions in a least squares sense

As discussed in §2, the CFM computes the correction function by (locally) solving the PDE in (5) within each of the cubic patches (Ω_{Γ_i}) that surround the interface. Within each patch, the CFM solves (5) by minimizing the functional J_i , which corresponds to imposing the PDE and the Cauchy boundary conditions (which are derived from the jump conditions of the Poisson problem) in a least squares sense, see (7). The challenge in this approach is that the surface integrals in J_i can be difficult to evaluate, especially when only an implicit representation of the of the interface is available. The source of the problem is that the patches can intersect the interface in an arbitrary fashion. Hence, performing a numerical quadrature over $\Gamma \cap \Omega_{\Gamma_i}$ is not trivial. However, it is possible to impose the jump conditions. in a least squares sense by using integrals over a slightly different piece of the interface that is more amenable to numerical quadrature. In this section we present a technique that is based on this premise.

Our goal is to impose the jump conditions over a piece of the interface that includes enough information to define a unique solution to (5) within each patch Ω_{Γ_i} . In ref. [1] we show that imposing these conditions over a piece of the interface that is approximately the size of one of the diagonals of the

patch works well in practice. This heuristic is reflected in the construction of the patch Ω_{Γ_i} (see figure 3), whose orientation is selected to approximately maximize the intersection of the surface with the patch, followed by imposing the jump conditions over $\Gamma \cap \Omega_{\Gamma_i}$. However, these conditions need not be enforced exactly over $\Gamma \cap \Omega_{\Gamma_i}$. Any section of the interface approximately the size of one of the diagonals will do.

A convenient choice is to impose the jump conditions over a “quadrangular” piece of the interface, i.e., a piece of the interface that can be mapped into a square by an affine transformation. If the transformation is bijective, one can use a numerical quadrature defined on the square to compute the integrals over the quadrangular piece of the interface. Furthermore, to guarantee that such a bijective transformation always exists, we split the interface into small quasi-flat sections and impose the jump conditions on the union of these sections. Moreover, because the interface is represented implicitly, it is not practical to define a transformation that acts on the interface alone. Instead, we introduce a local coordinate transformation that acts on \mathbb{R}^3 which, when restricted to the interface, defines an affine transformation that maps a section of the interface onto a square, even though the coordinate transformation itself may be nonlinear.

Hence, we introduce a technique for imposing jump conditions in a least squares sense that is based on (i) splitting the interface into several quasi-flat quadrangular sections – see figure 3(b), (ii) defining local coordinate transformations that map each of these sections onto a square, and (iii) introducing an approximate scheme to compute the mapping from the square back onto the interface sections. In §3.1 we introduce the local coordinate transformation, and discuss how to split the interface into small quasi-flat sections over which the transformation is bijective. In §3.2 we present an approximate scheme to compute the inverse transformation, which maps the square back a section of the interface. Finally, in §3.3 we discuss the modifications needed on the functional J_i to allow the implementation of the process described above.

3.1. Local coordinate transformation

Let \vec{x}_q denote a point on the interface. We are interested in defining a local coordinate transformation, $T : (x, y, z) \mapsto (\xi, \eta, \chi)$, such that a section of the interface in neighborhood of \vec{x}_q is mapped by T onto a square. To achieve this goal, we first define one of the coordinates as an approximation to the signed distance function: $\eta = \phi / |\vec{\nabla}\phi(\vec{x}_q)|$, where ϕ is the level set

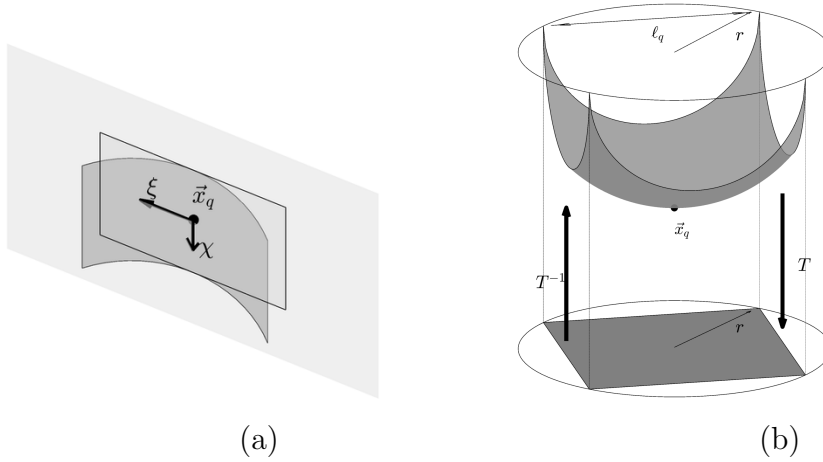

Figure 4: (a) The coordinates ξ and χ are defined by the orthogonal projection onto the plane tangent to the interface at \vec{x}_q . (b) The transformation T on a quadrangular section of the surface of a sphere of radius r . The transformation is bijective if $\ell_q < \sqrt{2}r$. For general surfaces, $\ell_q < \sqrt{2}r_{\min}$ is a conservative upper bound on ℓ_q that guarantees that the transformation is bijective (here r_{\min} is the smallest local curvature radius).

function. Thus the interface lies on the $\eta = 0$ surface. The other coordinates are given by an orthogonal projection onto the plane tangent to the interface at \vec{x}_q , as depicted in figure 4(a). The computation of the transformation T is summarized in algorithm 3 below. Note that the quadrangular piece of the interface mapped onto a square will be defined, implicitly, via the inverse of the transformation T .

Furthermore, let $r_{\min} > 0$ denote the minimum radius of curvature of the interface in a neighborhood of \vec{x}_q . Then, as illustrated in figure 4(b), for any $\ell_q < \sqrt{2}r_{\min}$, the inverse transformation T^{-1} exists on the square

$$Q := \{\eta = 0 \text{ and } (\xi, \chi) \in [-\ell_q/2, \ell_q/2]^2\}. \quad (8)$$

Then $T^{-1}(Q)$ is a quadrangular piece of the interface, approximately centered at \vec{x}_q , with area approximately equal to ℓ_q^2 . In practice, however, we take ℓ_q to be smaller than this upper limit to guarantee accuracy in the computation of the inverse transformation. We discuss the practical limits on ℓ_q in §3.2.

Furthermore, \vec{x}_q does not have to lie exactly on the interface. If \vec{x}_q is close to the interface (in the ℓ_q -scale), ξ and χ are given by an orthogonal projection onto a plane approximately tangent to the interface. This is enough to define a bijective transformation following algorithm 3.

Algorithm 3 Construct the transformation T in the neighborhood of \vec{x}_q .

1: Determine tangent plane at \vec{x}_q

$$\vec{\nabla}\phi_q \leftarrow \vec{\nabla}\phi(\vec{x}_q)$$

$$\hat{v}_1 \leftarrow \vec{\nabla}\phi_q / |\vec{\nabla}\phi_q|$$

▷ normal vector

$$[\hat{v}_2, \hat{v}_3] \leftarrow \text{ORTHOAGONAL}(\hat{v}_1)$$

▷ see algorithm 2

2: Define η

$$\bar{\phi} \leftarrow |\vec{\nabla}\phi_q|$$

$$\eta(\vec{x}) = \phi / \bar{\phi}$$

3: Define ξ and χ

$$\xi = \hat{v}_2 \cdot (\vec{x} - \vec{x}_q)$$

▷ projection onto tangent plane

$$\chi = \hat{v}_3 \cdot (\vec{x} - \vec{x}_q)$$

To implement the present technique, we use the grid G_Γ on which the level set function is represented to: (i) locate the centers (\vec{x}_c) of the local transformations; and (ii) define ℓ_q . Let h_Γ be the characteristic grid spacing of G_Γ . Then, for each cell on G_Γ that crosses the interface, we set \vec{x}_q as the approximate projection of the center of the cell onto the interface:

$$\vec{x}_q = \vec{x}_c - \phi(\vec{x}_c) \left(\frac{\vec{\nabla}\phi(\vec{x}_c)}{|\vec{\nabla}\phi(\vec{x}_c)|^2} \right), \quad (9)$$

where \vec{x}_c denotes the center of the cell. Furthermore, we associate with this cell a quadrangular section of interface of characteristic length $\ell_q = h_\Gamma$. Thus we use the grid G_Γ to provide the scale on which to split the interface into quasi-flat sections (this assumes that G_Γ “resolves” the surface). In particular, note that G_Γ may be distinct from the grid used to solve the Poisson equation. We make this distinction explicit by denoting the grid in which the Poisson equation is solved by G_P , with characteristic grid spacing h_P .

3.2. Inverse transformation

The efficiency of the technique presented here hinges on the fact that the inverse transformation T^{-1} is not computed exactly. Instead, the inverse transformation is approximated using polynomials of the same degree

as the level set representation (which we assume is done using Hermite interpolation, as in the Gradient-Augmented Level Set method [36]). This approximation is justified because we assume that the interface is locally quasi-flat. This assumption implies that

$$T \circ T_{\text{approx}}^{-1} = I + O(h_{\Gamma}^{p+1}),$$

where T_{approx}^{-1} denotes the approximate inverse transformation, and $3p$ ($2p$ in 2-D) is the degree of the polynomials used to represent the level set.

Sketch of the proof. Since the interface is quasi-flat, the inverse transformation T^{-1} exists and is smooth in a neighborhood of the interface. Hence, we can always approximate this inverse transformation with a polynomial. In the case of a Hermite polynomial of degree $3p$ we can guarantee that

$$T_{\text{approx}}^{-1} = T^{-1} + O(h_{\Gamma}^{p+1}).$$

Furthermore, since the forward transformation is composed of polynomials of degree at most $3p$, it is easy to see that $T \circ T_{\text{approx}}^{-1} = I + O(h_{\Gamma}^{p+1})$. ♣

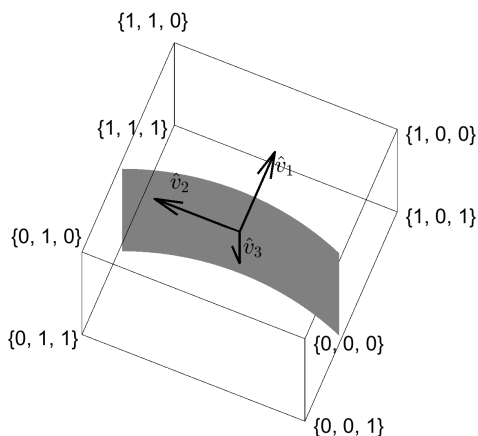

Figure 5: h_{Γ}^3 cube centered on \vec{x}_q , with edges aligned with \hat{v}_1 , \hat{v}_2 and \hat{v}_3 .

Next we describe the computation of the the inverse transformation. $T_{\text{approx}}^{-1} : (\xi, \eta, \chi) \mapsto (x, y, z)$ is approximated by three p -Hermite polynomials, one for each coordinate variable. A p^{th} Hermite interpolant is completely determined by, for example, the target function value and all its derivatives

$\partial^{(\alpha_1+\alpha_2+\alpha_3)}/\partial\xi^{\alpha_1}\eta^{\alpha_2}\chi^{\alpha_3}$, $\max(\alpha_1, \alpha_2, \alpha_3) \leq p - 2$, at the eight corners of a cube in \mathbb{R}^3 (we call this the “data”). For us this could be the $[-\ell_q/2, \ell_q/2]^3$ cube, C_q , centered at $T(\vec{x}_q)$ in the (ξ, η, χ) coordinate system, with the data following from the inverse function theorem and the definition of T . However, the location of the vertices of C_q is not known a priori in the (x, y, z) coordinate system. Hence we select a more convenient one, specifically: the h_Γ^3 cube centered at \vec{x}_q and aligned with \hat{v}_1, \hat{v}_2 , and \hat{v}_3 in the (x, y, z) coordinate system – see figure 5. We denote the vertices of this cube by $\vec{x}_{\vec{\gamma}}$, $\vec{\gamma} \in \{0, 1\}^3$.

Note that, since the interface is quasi-flat in a neighborhood of \vec{x}_q , the points $T(\vec{x}_{\vec{\gamma}})$ are close to the vertices of the cube in the (ξ, η, χ) coordinate system. Thus, the linear system that fits the Hermite interpolation through data given at $\vec{x}_{\vec{\gamma}}$ is close to the identity. The computation of T_{approx}^{-1} is summarized in algorithm 4. For ease of presentation, in algorithm 4 we denote the Hermite interpolations collectively by $\vec{\mathcal{H}}$, and we use the notation $\vec{\theta} = \{\xi, \eta, \chi\}$ and $\vec{V} = \{\hat{v}_1, \hat{v}_2, \hat{v}_3\}$. Furthermore, step 4 of algorithm 4 represents the computation of derivatives of T^{-1} by application of the inverse function theorem.

Algorithm 4 Computation of the inverse transformation T_{approx}^{-1}

- 1: $\vec{x}_{\{0,0,0\}} \leftarrow \vec{x}_q - (h_\Gamma/2)\vec{v} \cdot \{1, 1, 1\}$
 - 2: $\vec{x}_{\vec{\gamma}} \leftarrow \vec{x}_{\{0,0,0\}} + (h_\Gamma)\vec{v} \cdot \vec{\gamma}$, $\vec{\gamma} \in \{0, 1\}^3$ ▷ approximate corners
 - 3: $\vec{\theta}_{\vec{\gamma}} \leftarrow T(\vec{x}_{\vec{\gamma}})$
 - 4: $\frac{\partial^{(\vec{\alpha})}\vec{x}}{\partial\vec{\theta}^{\vec{\alpha}}}\Big|_{\vec{\theta}_{\vec{\gamma}}} \leftarrow \left(\frac{\partial^{(\vec{\alpha})}\vec{\theta}}{\partial^{(\vec{\alpha})}\vec{x}}\Big|_{\vec{x}_{\vec{\gamma}}} \right)^{-1}$, $\max(\alpha_i) \leq p - 2$ ▷ inv. function theorem
 - 5: Solve:

$$\begin{cases} \vec{\mathcal{H}}(\vec{\theta}_{\vec{\gamma}}) = \vec{x}_{\vec{\gamma}} \\ \frac{\partial\vec{\mathcal{H}}}{\partial\vec{\theta}}(\vec{\theta}_{\vec{\gamma}}) = \frac{\partial^{(\vec{\alpha})}\vec{x}}{\partial\vec{\theta}^{\vec{\alpha}}}\Big|_{\vec{\theta}_{\vec{\gamma}}} \end{cases}$$
-

The Hermite interpolation incurs an $O(h^{p+1}D^{(p+1)}T^{-1})$ error in approximating T^{-1} , where $D^{(p+1)}$ denotes derivatives of order $p + 1$. Hence, an accurate approximation is only possible when derivatives of order $p + 1$ are bounded. Furthermore, the derivatives of T^{-1} are related to the ratio ℓ_q/r_{\min} , i.e., to how flat the section of the interface is with respect to ℓ_q . We con-

ture that, for a given p , it is possible to choose a constant $c > 0$ such that $\ell_q/r_{\min} < c$ guarantees $D^{(p+1)} = O(1)$. For a spherical interface, and $p = 3$, we can show that $c \approx 0.4$. Thus we propose $\ell_q/r_{\min} < 0.4$ as a conservative upper bound that guarantees an accurate Hermite cubic approximation to T^{-1} in general circumstances.

Nevertheless, estimating r_{\min} in practice is not straightforward. For this reason, we prefer to use the determinant of the Jacobian on the $\xi - \chi$ plane,

$$\text{Jac} = \left\| \frac{\partial \vec{x}}{\partial \xi} \times \frac{\partial \vec{x}}{\partial \chi} \right\|_{T^{-1}(0, \xi, \chi)}, \quad (10)$$

evaluated at the Gaussian quadrature points² as an indicator for the adequacy of the size of ℓ_q . As discussed in §3.3, the Jacobian is needed to compute the integrals over the interface. Hence, computing this indicator does not add to the computational cost. For a spherical interface we can show that $c = 0.4$ implies $\text{Jac} > 0.83$. Hence, we use this threshold to verify whether ℓ_q is small enough in general cases.

3.3. Least squares statement

In §3.1 we show how to define a local coordinate transformation T that maps a quadrangular section of the interface into a square Q – see (8). One can impose the jump conditions on this section of the interface by computing integrals of the form

$$\int_{T^{-1}(Q)} \mathcal{F}^2 dS = \int_{-\ell_s/2}^{\ell_s/2} \int_{-\ell_s/2}^{\ell_s/2} \mathcal{F}^2(T^{-1}(0, \xi, \chi)) \left\| \frac{\partial \vec{x}}{\partial \xi} \times \frac{\partial \vec{x}}{\partial \chi} \right\|_{T^{-1}(0, \xi, \chi)} d\xi d\chi, \quad (11)$$

where \mathcal{F} represents a jump condition, such as (5b) or (5c). Furthermore, in §3.2 we introduce a scheme to evaluate the inverse transformation T^{-1} efficiently. Hence, one can evaluate (11) accurately and efficiently as

$$\int_{T^{-1}(Q)} \mathcal{F}^2 dS \approx \sum_i \left(w_i \mathcal{F}^2(T^{-1}(0, \xi_i, \chi_i)) \left\| \frac{\partial \vec{x}}{\partial \xi} \times \frac{\partial \vec{x}}{\partial \chi} \right\|_{T^{-1}(0, \xi_i, \chi_i)} \right) \quad (12)$$

where the w_i are the weights of a numerical quadrature defined over $[-\ell/2, \ell/2]^2$, and (ξ_i, χ_i) are the integration points.

²Specifically, the Gaussian quadrature points used to compute the surface integrals needed.

Now, our goal is to impose jump conditions on a piece of the interface that is approximately the size of the diagonal of the patch Ω_{Γ_i} . We achieve this goal by imposing the jump conditions over each quadrangular section separately, and adding the contributions of all the sections whose union approximates the diagonal of the patch. We incorporate the new technique of imposing jump conditions in a least squares sense into the CFM by modifying the minimization function J_i to

$$\begin{aligned}
J_i^{\text{new}} &= \frac{\ell_d^4}{V_i} \int_{\Omega_{\Gamma_i}} (\nabla^2 D - f_D)^2 dV \\
&+ \sum_{k=1}^{n_i} \frac{c_P}{S_{i_k}} \int_{\Gamma_{i_k}} [(D - a)^2 + \ell_d^2 (D_n - b)^2] dS,
\end{aligned} \tag{13}$$

where Γ_i denotes the set of sections that approximate the diagonal of the patch. In practice, we add contributions from the of the n_i sections whose centers are within a distance $\sqrt{2}\ell_d$ from the center of Ω_{Γ_i} .

4. Results

In this section we verify the accuracy and robustness of the new formulation of the CFM with examples in 2-D and 3-D. In the first two examples we reproduce 2-D problems discussed in ref. [1], and compare the accuracy of the new formulation to that of the an earlier implementation of the CFM. Furthermore, we also explore the concept of level set functions represented in independent grids and solve problems involving multiple interfaces close together.

The results shown here are computed with an overall fourth order accurate scheme. Namely, we discretize the Poisson equation using the standard 9-point stencil in 2-D, and the equivalent 19-point stencil in 3-D. Furthermore, we represent the correction function with Hermite cubic polynomials, which is consistent with fourth order of accuracy. Finally, we represent the interfaces using the Gradient-Augmented Level-Set(GALS) method [36], which is also based on Hermite cubic polynomials.

Below we use analytic expressions to define the model problems, but only the appropriate discrete data defined on a computational grid are used as inputs for the code (this is close to a practical situation in which data defining the interface is the result of a computation on the same grid). In the examples u denotes the solution, while ϕ denotes the level set function.

We verify accuracy by evaluating the L_∞ norm of the error in the solution and its gradient.

4.1. Smooth 5-pointed star

Here we reproduce example 2 of ref. [1], which involves a smooth 5-pointed star. By considering a smooth interface we guarantee that we can split the interface into quasi-flat segments, without the need of special considerations near singular points (e.g., corners). Note that in this example G_P and G_Γ are the same grid. The problem is defined as follows.

- $\phi(x, y) = (x - 0.5)^2 + (y - 0.5)^2 - (0.25 + 0.05 \sin(5\varphi(x, y)))^2$.
- $\varphi(x, y) = \arctan\left(\frac{y - 0.5}{x - 0.5}\right)$.
- $\Omega_1 = \{(x, y) \in [0, 1]^2 \mid \phi(x, y) \leq 0\}$.
- $\Omega_2 = \{(x, y) \in [0, 1]^2 \mid \phi(x, y) > 0\}$.
- $u_1(x, y) = 0$.
- $u_2(x, y) = \exp(x) \cos(y)$.

Figure 6 shows the interface immersed into the Cartesian grid G_P used to solve the Poisson equation, along with a plot of the solution obtained with the CFM. Figure 7 shows a comparison of the error obtained with the new and earlier implementations of the CFM. This figure shows that the new implementation converges to the expected fourth order of accuracy, albeit resulting in larger errors than the earlier implementation. We believe the larger errors are due to the use of the node-centered construction of the CFM patch. A different construction of the CFM patch is used in ref. [1]. As explained in ref. [1], this alternative patch construction produces smaller patches, which lead to smaller errors. However, the node-centered approach is simpler to implement.

4.2. Touching circles

We also reproduce example 5 of ref. [1], which involves two circular interfaces that touch at one point. In this example the interfaces are represented by level sets defined in independent grids: G_{Γ_1} and G_{Γ_2} . However, to be consistent with the implementation of ref. [1], we choose G_{Γ_1} and G_{Γ_2} to be the same as G_P . The problem is defined as follows.

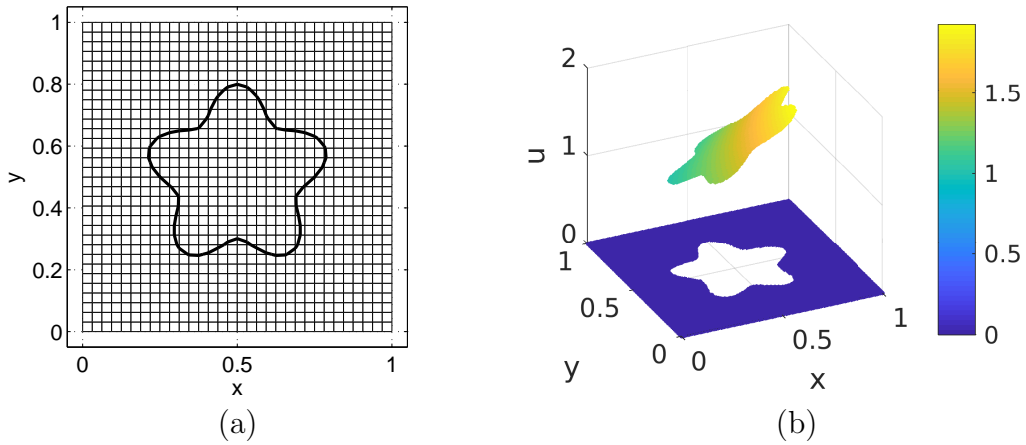

Figure 6: Example 1. (a) Interface immersed into G_P . (b) Solution given by the CFM.

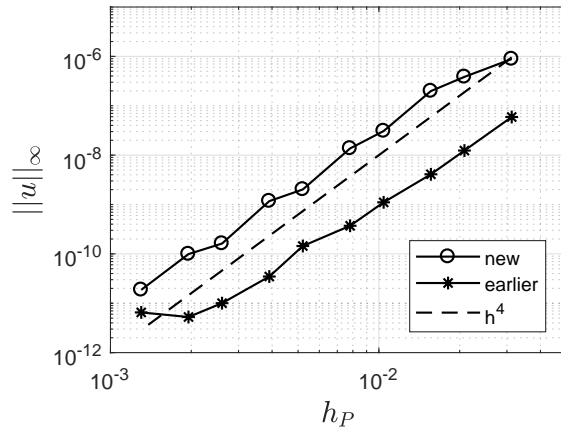

Figure 7: Example 1. Error convergence in the L_∞ norm. Comparison between new and earlier implementations of the CFM.

- $\phi_1(x, y) = (x - 0.5 - 0.2 \cos(\pi/e^2))^2 + (y - 0.5 - 0.2 \sin(\pi/e^2))^2 - 0.01$.
- $\phi_2(x, y) = (x - 0.5)^2 + (y - 0.5)^2 - 0.09$.
- $\Omega_1 = \{(x, y) \in [0, 1]^2 \mid \phi_1(x, y) \leq 0\}$.
- $\Omega_2 = \{(x, y) \in [0, 1]^2 \mid \phi_1(x, y) > 0, \phi_2(x, y) \leq 0\}$.

- $\Omega_3 = \{(x, y) \in [0, 1]^2 \mid \phi_1(x, y) > 0, \phi_2(x, y) > 0\}$.
- $u_1(x, y) = \sin(\pi x) \sin(\pi y) + 5$.
- $u_2(x, y) = \sin(\pi x)(\sin(\pi y) - \exp(\pi y))$.
- $u_3(x, y) = \exp(x)(x^2 \sin(y) + y^2)$.

Figure 8 shows the interfaces immersed into the Cartesian grid G_P used to solve the Poisson equation, along with a plot of the solution obtained with the CFM. Since the jump conditions (1b-c) are linear, one can solve for correction functions associated with each interface independently and combine them as needed – see remark 2. As shown in fig. 8(b), this approach allows for arbitrarily close interfaces

Remark 2. In practice, the interfaces seen by the CFM are subject to errors due to the level set representation. Hence, the “effective” interfaces likely do not touch perfectly at just one point. They may cross over, or not touch at all. However, the CFM can handle these situations seamlessly by computing correction functions due to each of the interfaces independently. For instance, when the solution domain is subdivided into three regions by two interfaces, such as in figure 8, the CFM computes $D_{12} = u_2 - u_1$ and $D_{13} = u_3 - u_1$, where u_i denotes the solution restricted to each of the three regions. Since the jump conditions (1b-c) are linear, one can combine this information to compute $D_{23} = u_3 - u_2 = D_{13} - D_{12}$ as needed. ♣

Figure 9 shows a comparison of the error obtained with the new and earlier implementations of the CFM. Once again, the errors produced with the new algorithm are larger than the ones produced with the older method, but the overall convergence is fourth order in both cases.

4.3. Three interfaces in 2-D

This 2-D example, which is not in [1], illustrates the application of the new implementation of the CFM to solve problems with more than two interfaces close together. That is, we solve the following problem with three interfaces:

- $\phi_1(x_1, y_1) = (x_1 - 0.3)^2 + (y_1 - 0.3)^2 - 0.05$.
- $\phi_2(x_2, y_2) = (x_2 - 0.3)^2 + (y_2 - 0.3)^2 - (\sqrt{3}/10 + 0.05 \sin(5\varphi_2(x_2, y_2)))^2$.

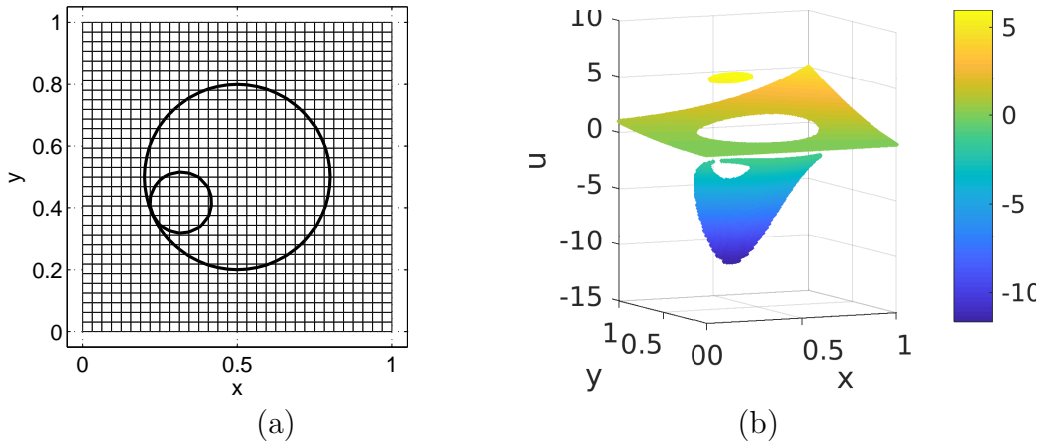

Figure 8: Example 2. (a) Interfaces immersed into G_P , with circles that touch at single point. (b) Solution obtained with the CFM.

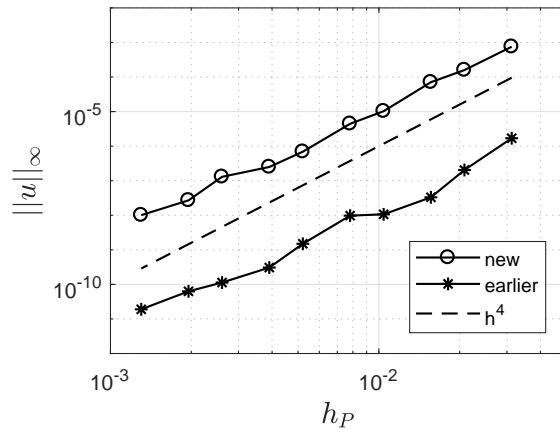

Figure 9: Example 2. Error convergence in the L_∞ norm. Comparison between new and earlier implementations of the CFM.

- $\phi_2(x_3, y_3) = (x_3 - 0.25)^2 + (y_3 - 0.25)^2 - (0.15 + 0.05 \sin(2\varphi_3(x_3, y_3)))^2$.
- $\varphi_2(x_2, y_2) = \arctan\left(\frac{y_2 - 0.3}{x_2 - 0.3}\right)$.
- $\varphi_3(x_3, y_3) = \arctan\left(\frac{y_3 - 0.25}{x_3 - 0.25}\right)$.

- $\Omega_1 = \{(x_1, y_1) \in [0, 0.6]^2 \mid \phi_1(x_1, y_1) \leq 0\}$.
- $\Omega_2 = \{(x_2, y_2) \in [0, 0.6]^2 \mid \phi_2(x_2, y_2) \leq 0\}$.
- $\Omega_3 = \{(x_3, y_3) \in [0, 0.5]^2 \mid \phi_3(x_3, y_3) \leq 0\}$.
- $\Omega_4 = \{(x, y) \in [0, 1]^2 \mid \phi_i(x, y) > 0, i = 1, 2, 3\}$.
- $u_1(x, y) = \exp(x)(x^2 \sin(y) + y^2)$.
- $u_2(x, y) = \sin(\pi x) \sin(\pi y) + 10$.
- $u_3(x, y) = x y + 10$.
- $u_4(x, y) = 10(x^2 + y^2)$.

In this example the level set grids (G_{Γ_1} , G_{Γ_2} , and G_{Γ_3}) are not the same as G_P . In the expressions above, each level set is defined in terms of the Cartesian coordinates aligned with the corresponding grid. These coordinates are defined as follows:

$$\begin{aligned}
x_1 &= x - 0.34, \\
y_1 &= y - 0.37, \\
x_2 &= (x - 0.29) \cos(35\pi/180) + (y + 0.1) \sin(35\pi/180), \\
y_2 &= -(x - 0.29) \sin(35\pi/180) + (y + 0.1) \cos(35\pi/180), \\
x_3 &= (x - 0.885) \cos(75\pi/180) + (y + 0.048) \sin(75\pi/180), \\
y_3 &= -(x - 0.885) \sin(75\pi/180) + (y + 0.048) \cos(75\pi/180).
\end{aligned}$$

We illustrate the concept of independent level set grids in figure 10(a). In this figure we show G_{Γ_2} laid over G_P , along with the immersed interfaces. The solution obtained with the CFM is shown in figure 10(b). Once again we observe that the CFM produces good results in the presence of multiple interfaces. Furthermore, in addition to the expected fourth order convergence of the error in the solution, we also observe third order convergence of the error in the gradient, as shown in figure 11.

4.4. Sphere with bumps

In this example we apply the new implementation of the CFM to solve the following 3-D problem, which is illustrated in figure 12.

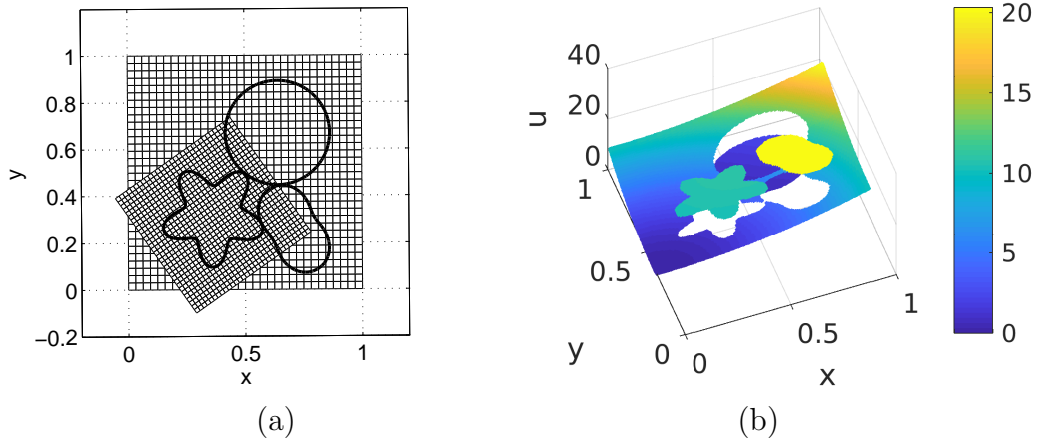

Figure 10: Example 3. (a) Interfaces immersed into G_P . The grid G_{Γ_2} used to represent ϕ_2 is also shown. (b) Solution obtained with the CFM.

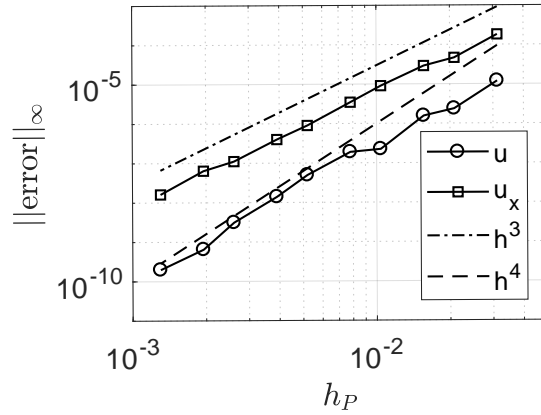

Figure 11: Example 3. Convergence of the error of in the solution and its x -derivative in the L_∞ norm. The y -derivative behaves similarly.

- $\phi(x_1, y_1, z_1) = (x_1 - 0.35)^2 + (y_1 - 0.35)^2 + (z_1 - 0.35)^2 - r^2$.
- $r(\varphi, \psi) = \sqrt{3}/8 + (0.28/\pi)(\varphi - \varphi^2/\pi) \sin(3\varphi) \sin(4\psi)$.
- $\varphi(x_1, y_1) = \arctan\left(\frac{y_1 - 0.35}{x_1 - 0.35}\right)$.

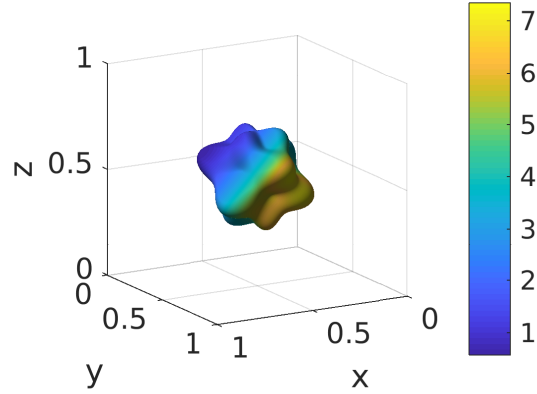

Figure 12: Example 4. Interface immersed into G_P , color-coded by the intensity of the jump in the solution across it.

- $\psi(x_1, y_1, z_1) = \arccos \left(\frac{z_1 - 0.35}{\sqrt{(x_1 - 0.35)^2 + (y_1 - 0.35)^2 + (z_1 - 0.35)^2}} \right)$.
- $\Omega_1 = \{(x_1, y_1, z_1) \in [0, 0.7]^3 \mid \phi(x_1, y_1, z_1) \leq 0\}$.
- $\Omega_2 = \{(x, y, z) \in [0, 1]^3 \mid \phi(x, y, z) > 0\}$.
- $u_1(x, y, z) = \sin(\pi(x + z)/\sqrt{2}) \exp(\pi y)$.
- $u_2(x, y, z) = 0$.

In the expressions above, the level set ϕ is defined in terms of the Cartesian coordinates aligned with G_Γ . These coordinates are given by

$$\begin{aligned} x_1 &= x - 0.13, \\ y_1 &= y - 0.1, \\ z_1 &= z - 0.15. \end{aligned}$$

Figure 12 shows the interface, color-coded by the intensity in the jump in the solution across it. Figure 13 shows a 2-D slice of the solution computed with the CFM, as well as the interface immersed into the Cartesian grid at the slicing plane. The error of the solution and its gradient are plotted in figure 14. Just as in 2-D, the accuracy is fourth order in the solution and third order in the gradient.

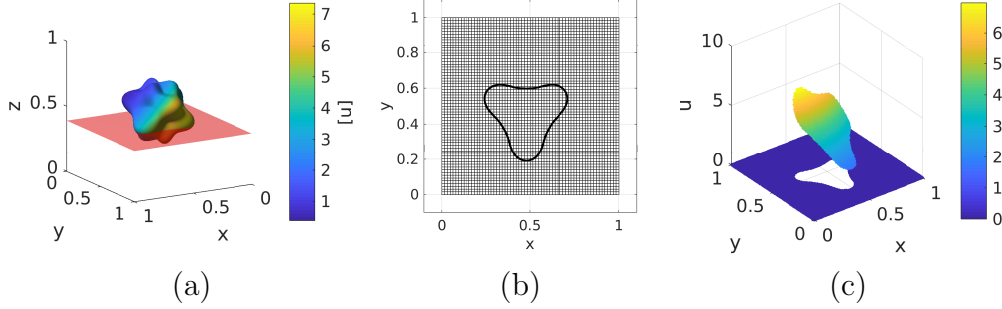

Figure 13: Example 4. 2-D slice of the solution. (a) Location of the slicing plane ($z = 0.39$). (b) The grid G_P . (c) Solution obtained with the CFM.

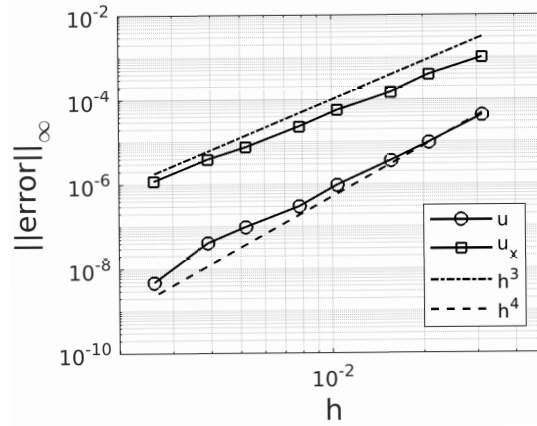

Figure 14: Example 4. Convergence of the error in the solution and its x -derivative in the L_∞ norm. The y and z -derivatives behave similarly.

4.5. Touching spheres

Here we present a 3-D extension of example 2 in §4.2. We consider two spherical interfaces that touch at a single point, as shown in figure 15. The interfaces are each represented using independent level set grids, and the problem is defined as follows:

- $\phi_1(x_1, y_1, z_1) = (x_1 - 0.40)^2 + (y_1 - 0.40)^2 + (z_1 - 0.40)^2 - 0.09$.
- $\phi_2(x_2, y_2, z_2) = (x_2 - 0.25)^2 + (y_2 - 0.25)^2 + (z_2 - 0.25)^2 - 0.01$.

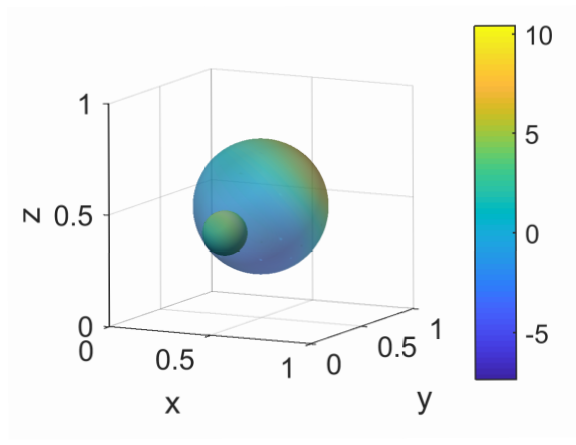

Figure 15: Example 5. Interfaces immersed into G_P , color-coded by the intensity of the jumps in the solution across them. Transparency is applied to the outer interface to show the internal interface. The spheres touch at a single point.

- $\Omega_1 = \{(x_1, y_1, z_1) \in [0, 0.8]^3 \mid \phi_1(x_1, y_1, z_1) \leq 0\}$.
- $\Omega_2 = \{(x_2, y_2, z_2) \in [0, 0.5]^3 \mid \phi_2(x_2, y_2, z_2) \leq 0\}$.
- $\Omega_3 = \{(x, y, z) \in [0, 1]^3 \mid \phi_1(x, y, z) > 0, \phi_2(x, y, z) > 0\}$.
- $u_1(x, y, z) = (\sin(\pi x) \sin(\pi y) + 5) \log(x + z + 2)$.
- $u_2(x, y, z) = \sin(\pi(x + z)) (\sin(\pi y) - \exp(\pi y))$.
- $u_3(x, y, z) = \exp(x)(x^2 \sin(y) + y^2) \cos(\pi z)$.

In the expressions above, the level sets are defined in terms of the respective grid coordinates, which are given by

$$\begin{aligned}
 x_1 &= x - 0.1, \\
 y_1 &= y - 0.1, \\
 z_1 &= z - 0.1, \\
 x_2 &= x - 0.25 - 0.2 \cos(\pi/e^2) \cos(\pi/3\varphi), \\
 y_2 &= y - 0.25 - 0.2 \sin(\pi/e^2) \cos(\pi/3\varphi), \\
 z_2 &= z - 0.25 - 0.2 \sin(\pi/3\varphi),
 \end{aligned}$$

where φ denotes the golden ratio, $\varphi = \frac{1+\sqrt{5}}{2}$.

Figure 15 shows the interfaces, color-coded by the intensity of the jumps in the solution across them. Figure 16 shows a 2-D slice of the solution, as computed with the CFM, on a plane close to the contact point between the spheres. The error in the solution and gradient are plotted in figure 17. Note that the accuracy of the solution and gradient *does not degrade*, even though the interfaces are arbitrarily close.

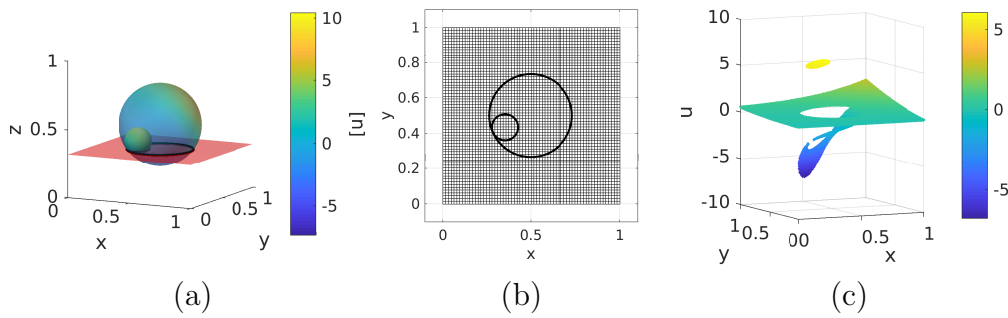

Figure 16: Example 5. 2-D slice of the solution. (a) Location of the slicing plane ($z = 0.39$). (b) The grid G_P . (c) Solution obtained with the CFM.

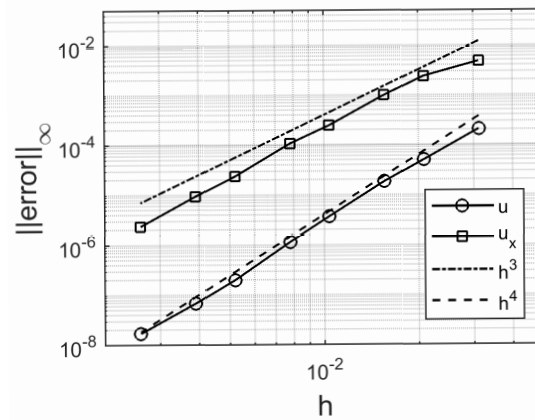

Figure 17: Example 5. Convergence of the error in the solution and its x -derivative in the L_∞ norm. The y and z -derivatives behave similarly.

4.6. 3-D interfaces touching at two points

In this final example we apply the CFM to a 3-D problem with two interfaces that touch at two points, as shown in figure 18. The interfaces are represented using separate level set grids. The problem is defined as follows:

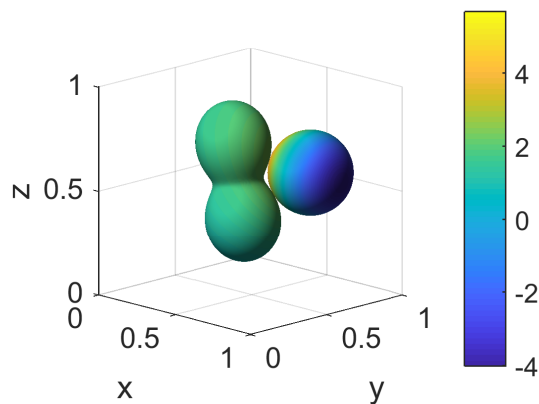

Figure 18: Example 6. Interfaces immersed into G_P , color-coded by the intensity of the jumps in the solution across them. The interfaces touch at two distinct points.

- $R = \sqrt{(x_1 - 0.425)^2 + (y_1 - 0.425)^2 + (z_1 - 0.425)^2}$.
- $\psi(x_1, y_1, z_1) = \arccos\left(\frac{z_1 - 0.425}{R^2}\right)$.
- $r(\psi) = 0.25 + 0.13 \cos(2\psi)$.
- $\phi_1(x_1, y_1, z_1) = R^2 - r^2$
- $\phi_2(x_2, y_2, z_2) = (x_2 - 0.3)^2 + (y_2 - 0.3)^2 + (z_2 - 0.3)^2 - 0.04$.
- $\Omega_1 = \{(x_1, y_1, z_1) \in [0, 0.85]^3 \mid \phi_1(x_1, y_1, z_1) \leq 0\}$.
- $\Omega_2 = \{(x_2, y_2, z_2) \in [0, 0.6]^3 \mid \phi_2(x_2, y_2, z_2) \leq 0\}$.
- $\Omega_3 = \{(x, y, z) \in [0, 1]^3 \mid \phi_1(x, y, z) > 0, \phi_2(x, y, z) > 0\}$.
- $u_1(x, y, z) = x y z$.

- $u_2(x, y, z) = \exp(x) \cos(y) \sin(z)$.
- $u_3(x, y, z) = \log(\sqrt{(x - 0.661)^2 + (y - 0.651)^2 + (z - 0.636)^2})$.

Note that, in the expressions above, the level sets are defined in terms of their respective grid coordinates, given by

$$\begin{aligned} x_1 &= (x - 0.1) \cos(10\pi/180) + (z - 0.05) \sin(10\pi/180), \\ y_1 &= y - 0.05, \\ z_1 &= -(x - 0.1) \sin(10\pi/180) + (z - 0.05) \cos(10\pi/180), \\ x_2 &= x - 0.1047, \\ y_2 &= y - 0.1842, \\ z_2 &= z - 0.1249. \end{aligned}$$

Figure 18 shows the interfaces, color-coded by the intensity of the jump in the solution across them. Figure 19 shows a 2-D slice of the solution, as computed with the CFM, on a plane close to one of the contact points. The errors in the solution and its gradient are plotted in figure 20. These results corroborate the accuracy of this CFM implementation, as well as its robustness with respect to situations with arbitrarily close interfaces.

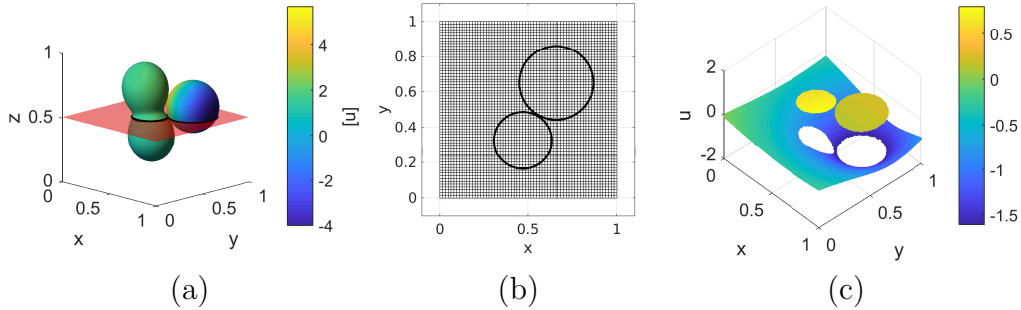

Figure 19: Example 6. 2-D slice of the solution. (a) Location of the slicing plane. (b) The grid G_P . (c) Solution obtained with the CFM.

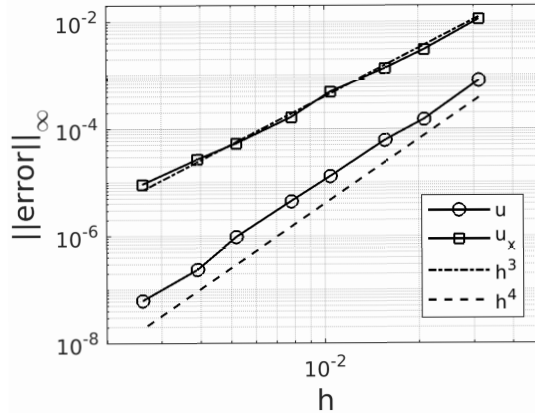

Figure 20: Example 6. Convergence of the error in the solution and its x -derivative in the L_∞ norm. The other derivatives behave similarly.

5. Conclusion

We present a new technique to impose jump conditions in a least squares sense, which we incorporate into the *Correction Function Method* (CFM). This results in a re-formulation of the CFM, allowing the solution of Poisson equations with imposed discontinuities across interfaces represented implicitly (i.e., as the zero contour of a level set function) in 2-D or 3-D. This new formulation preserves the main features of the CFM, such as high order of accuracy and compact discretization stencils.

Imposing jump conditions in a least squares sense is a key concept in the CFM. However, implementing this step requires evaluating integrals over pieces of the interface, difficult to do (particularly in 3-D) if the interface is given via a level set function. The new technique addresses this challenge as follows. (i) Introduce local coordinate transformations (LCT), defined only using knowledge of the level set function. The LCT map (small enough) sections of the interface into squares in the global coordinates. (ii) Develop an efficient scheme to compute the LCT. (iii) Re-formulate the CFM so that it requires evaluation of integrals over interface sections amenable to treatment by a LCT.

With numerical experiments we show that the reformulation of the CFM incorporating the new technique is efficient, accurate, and robust with respect

to the arbitrary fashion in which the interface can intersect the computational grid. In particular, we show fourth order of accuracy when solving the Poisson equation (1) when β is constant. An extension of this work to problems involving discontinuous β is the subject of current work.

Acknowledgements

The research of A. N. Marques was partially supported by DARPA and AFOSR-COE. The research of J.-C. Nave was partially supported by the NSERC Discovery. The research of R. R. Rosales was partially supported by the National Science Foundation grants DMS-1719637 and DMS-1614043.

References

References

- [1] A. N. Marques, J.-C. Nave, R. R. Rosales, A Correction Function Method for Poisson problems with interface jump conditions, *Journal of Computational Physics* 230 (20) (2011) 7567–7597. doi:10.1016/j.jcp.2011.06.014.
- [2] A. N. Marques, A Correction Function Method to solve incompressible fluid flows to high accuracy with immersed geometries, Ph.D. thesis, Massachusetts Institute of Technology (2012).
- [3] A. N. Marques, J.-C. Nave, R. R. Rosales, High order solution of Poisson problems with piecewise constant coefficients and interface jumps, *Journal of Computational Physics* 335 (2017) 497 – 515. doi:10.1016/j.jcp.2017.01.029.
- [4] A. N. Marques, J.-C. Nave, R. R. Rosales, An embedded grid method for solving arbitrary poisson problems to high order of accuracy, in preparation.
- [5] C. S. Peskin, Flow patterns around heart valves: A numerical method, *Journal of Computational Physics* 10 (2) (1972) 252 – 271. doi:10.1016/0021-9991(72)90065-4.
- [6] C. S. Peskin, Numerical analysis of blood flow in the heart, *Journal of Computational Physics* 25 (3) (1977) 220–252. doi:10.1016/0021-9991(77)90100-0.

- [7] C. S. Peskin, B. F. Printz, Improved volume conservation in the computation of flows with immersed elastic boundaries, *Journal of Computational Physics* 105 (1) (1993) 33 – 46. doi:10.1006/jcph.1993.1051.
- [8] D. Goldstein, R. Handler, L. Sirovich, Modeling a no-slip flow boundary with an external force field, *Journal of Computational Physics* 105 (2) (1993) 354 – 366. doi:10.1006/jcph.1993.1081.
- [9] M.-C. Lai, C. S. Peskin, An immersed boundary method with formal second-order accuracy and reduced numerical viscosity, *Journal of Computational Physics* 160 (2) (2000) 705–719. doi:10.1006/jcph.2000.6483.
- [10] R. Cortez, M. Minion, The Blob Projection Method for immersed boundary problems, *Journal of Computational Physics* 161 (2) (2000) 428 – 453. doi:10.1006/jcph.2000.6502.
- [11] C. S. Peskin, The immersed boundary method, *Acta Numerica* 11 (2002) 479–517. doi:10.1017/S0962492902000077.
- [12] B. E. Griffith, C. S. Peskin, On the order of accuracy of the immersed boundary method: Higher order convergence rates for sufficiently smooth problems, *Journal of Computational Physics* 208 (1) (2005) 75–105. doi:10.1016/j.jcp.2005.02.011.
- [13] R. Mittal, G. Iaccarino, Immersed boundary methods, *Annual Review of Fluid Mechanics* 37 (1) (2005) 239–261. doi:10.1146/annurev.fluid.37.061903.175743.
- [14] D. B. Stein, R. D. Guy, B. Thomases, Immersed boundary smooth extension: A high-order method for solving PDE on arbitrary smooth domains using fourier spectral methods, *Journal of Computational Physics* 304 (2016) 252 – 274. doi:10.1016/j.jcp.2015.10.023.
- [15] H. Johansen, P. Colella, A Cartesian grid embedded boundary method for Poisson’s equation on irregular domains, *Journal of Computational Physics* 147 (1) (1998) 60–85. doi:10.1006/jcph.1998.5965.
- [16] A. Mayo, The fast solution of Poisson’s and the biharmonic equations on irregular regions, *SIAM Journal on Numerical Analysis* 21 (2) (1984) 285–299. doi:10.1137/0721021.

- [17] A. Mayo, The rapid evaluation of volume integrals of potential theory on general regions, *Journal of Computational Physics* 100 (2) (1992) 236–245. doi:10.1016/0021-9991(92)90231-M.
- [18] A. McKenney, L. Greengard, A. Mayo, A fast Poisson solver for complex geometries, *Journal of Computational Physics* 118 (2) (1995) 348 – 355. doi:10.1006/jcph.1995.1104.
- [19] R. J. LeVeque, Z. Li, The Immersed Interface Method for elliptic equations with discontinuous coefficients and singular sources, *SIAM Journal on Numerical Analysis* 31 (4) (1994) 1019–1044. doi:10.1137/0731054.
- [20] R. J. LeVeque, Z. Li, Immersed Interface Methods for Stokes flow with elastic boundaries or surface tension, *SIAM Journal on Scientific Computing* 18 (3) (1997) 709–735. doi:10.1137/S1064827595282532.
- [21] Z. Li, M.-C. Lai, The Immersed Interface Method for the Navier-Stokes equations with singular forces, *Journal of Computational Physics* 171 (2) (2001) 822–842. doi:10.1006/jcph.2001.6813.
- [22] L. Lee, R. J. LeVeque, An Immersed Interface Method for incompressible Navier-Stokes equations, *SIAM Journal on Scientific Computing* 25 (3) (2003) 832–856. doi:10.1137/S1064827502414060.
- [23] M. N. Linnick, H. F. Fasel, A high-order immersed interface method for simulating unsteady incompressible flows on irregular domains, *Journal of Computational Physics* 204 (1) (2005) 157 – 192. doi:10.1016/j.jcp.2004.09.017.
- [24] X. Zhong, A new high-order immersed interface method for solving elliptic equations with imbedded interface of discontinuity, *Journal of Computational Physics* 225 (1) (2007) 1066 – 1099. doi:10.1016/j.jcp.2007.01.017.
- [25] R. P. Fedkiw, T. Aslam, B. Merriman, S. Osher, A non-oscillatory Eulerian approach to interfaces in multimaterial flows (the Ghost Fluid Method), *Journal of Computational Physics* 152 (2) (1999) 457–492. doi:10.1006/jcph.1999.6236.

- [26] X.-D. Liu, R. P. Fedkiw, M. Kang, A boundary condition capturing method for Poisson's equation on irregular domains, *Journal of Computational Physics* 160 (1) (2000) 151–178. doi:10.1006/jcph.2000.6444.
- [27] M. Kang, R. P. Fedkiw, X.-D. Liu, A boundary condition capturing method for multiphase incompressible flow, *Journal of Scientific Computing* 15 (2000) 323–360. doi:10.1023/A:1011178417620.
- [28] F. Gibou, R. Fedkiw, A fourth order accurate discretization for the Laplace and heat equations on arbitrary domains, with applications to the Stefan problem, *Journal of Computational Physics* 202 (2) (2005) 577–601. doi:10.1016/j.jcp.2004.07.018.
- [29] F. Gibou, L. Chen, D. Nguyen, S. Banerjee, A level set based sharp interface method for the multiphase incompressible Navier-Stokes equations with phase change, *Journal of Computational Physics* 222 (2) (2007) 536–555. doi:10.1016/j.jcp.2006.07.035.
- [30] Y. C. Zhou, S. Zhao, M. Feig, G. W. Wei, High order matched interface and boundary method for elliptic equations with discontinuous coefficients and singular sources, *Journal of Computational Physics* 213 (1) (2006) 1 – 30. doi:10.1016/j.jcp.2005.07.022.
- [31] A. Guittet, M. Lepilliez, S. Tanguy, F. Gibou, Solving elliptic problems with discontinuities on irregular domains – the Voronoi Interface Method, *Journal of Computational Physics* 298 (2015) 747–765. doi:10.1016/j.jcp.2015.06.026.
- [32] Z. Li, T. Lin, X. Wu, New Cartesian grid methods for interface problems using the finite element formulation, *Numerische Mathematik* 96 (2003) 61–98. doi:10.1007/s00211-003-0473-x.
- [33] S. Hou, X.-D. Liu, A numerical method for solving variable coefficient elliptic equation with interfaces, *Journal of Computational Physics* 202 (2) (2005) 411–445. doi:10.1016/j.jcp.2004.07.016.
- [34] S. Hou, P. Song, L. Wang, H. Zhao, A weak formulation for solving elliptic interface problems without body fitted grid, *Journal of Computational Physics* 249 (0) (2013) 80 – 95. doi:10.1016/j.jcp.2013.04.025.

- [35] D. S. Abraham, A. N. Marques, J.-C. Nave, A correction function method for the wave equation with interface jump conditions, *Journal of Computational Physics* 353 (Supplement C) (2018) 281 – 299. doi:10.1016/j.jcp.2017.10.015.
- [36] J.-C. Nave, R. R. Rosales, B. Seibold, A gradient-augmented level set method with an optimally local, coherent advection scheme, *Journal of Computational Physics* 229 (10) (2010) 3802–3827. doi:10.1016/j.jcp.2010.01.029.