

Maximum matchings and minimum dominating sets in Apollonian networks and extended Tower of Hanoi graphs

Yujia jin^{a,b}, Huan Li^{a,c}, Zhongzhi Zhang^{a,c}

^a*Shanghai Key Laboratory of Intelligent Information Processing, Fudan University, Shanghai 200433, China*

^b*School of Mathematical Sciences, Fudan University, Shanghai 200433, China*

^c*School of Computer Science, Fudan University, Shanghai 200433, China*

Abstract

The Apollonian networks display the remarkable power-law and small-world properties as observed in most realistic networked systems. Their dual graphs are extended Tower of Hanoi graphs, which are obtained from the Tower of Hanoi graphs by adding a special vertex linked to all its three extreme vertices. In this paper, we study analytically maximum matchings and minimum dominating sets in Apollonian networks and their dual graphs, both of which have found vast applications in various fields, e.g. structural controllability of complex networks. For both networks, we determine their matching number, domination number, the number of maximum matchings, as well as the number of minimum dominating sets.

Keywords: Maximum matching, Minimum dominating set, Apollonian network, Tower of Hanoi graph, Matching number, Domination number, Complex network

1. Introduction

Let $\mathcal{G} = (\mathcal{V}, \mathcal{E})$ be an unweighted connected graph with vertex set \mathcal{V} of V vertices and edge set \mathcal{E} of E edges. A matching of graph \mathcal{G} is a subset \mathcal{M} of \mathcal{E} , in which no two edges are incident to a common vertex. A vertex linked to an edge in \mathcal{M} is said to be covered by \mathcal{M} , otherwise it is vacant. A maximum matching is a matching of maximum cardinality, with a perfect matching being a particular case covering all the V vertices. The cardinality of a maximum matching is called matching number of graph \mathcal{G} .

Email address: zhangzz@fudan.edu.cn (Zhongzhi Zhang)

A dominating set of a graph \mathcal{G} is a subset \mathcal{D} of \mathcal{V} , such that every vertex in $\mathcal{V} \setminus \mathcal{D}$ is connected to at least one vertex in \mathcal{D} . For a set \mathcal{D} with the smallest cardinality, we call it a minimum dominating set (MDS), the cardinality of which is called domination number of graph \mathcal{G} .

Both the maximum matching problem [1] and MDS problem [2] have found numerous practical applications in different areas. For example, matching number and the number of maximum matchings are relevant in lattice statistics [3], chemistry [4], while MDS problem is closely related to routing on ad hoc wireless networks [5] and multi-document summarization in sentence graphs [6]. Very recently, it was shown that maximum matchings and MDS are important analysis tools for structural controllability of complex networks [7], based on vertex [8] or edge [9] dynamics. In the context of vertex dynamics, the minimum number of driving vertices necessary to control the whole network and the possible configurations for sets of driving vertices are, respectively, determined by matching number and the number of maximum matchings in a bipartite graph derived from the original network [8]. In the aspect of edge dynamics, the structural controllability problem can be reduced to determining domination number and the number of MDSs in the original network [10, 11], which has an advantage of needing relatively small control energy [12].

Due to the wide applications, it is of theoretical and practical significance to study matching number and domination number in networks, as well as the number of maximum matchings and MDSs. In the past years, concerted efforts have been devoted to developing algorithms for the problems related to maximum matchings [13, 14, 15, 16, 17, 18, 19, 20, 21, 22] and minimum dominating sets [23, 24, 25, 26, 27, 28] from the community of mathematics and theoretical computer science. However, solving these problems is a challenge and often computationally intractable. For example, finding a MDS of a graph is NP-hard [2]; enumerating maximum matchings in a generic graph is arduous [29, 30], which is #P-complete even in a bipartite graph [30]. At present, the maximum matching and MDS problems continue to be an active research object [31, 32].

Since determining matching number and domination number, especially counting all maximum matchings and minimum dominating sets in a general graph are formidable, it is therefore of much interest to construct or find particular graphs for which the maximum matching and MDS problem can be solved exactly [1]. In this paper, we study maximum matchings and minimum dominating sets in Apollonian networks [33] and their dual graphs—extended Tower of Hanoi graphs, which are obtained from the Tower of Hanoi graphs by adding a special vertex connected to all its three extreme

vertices [34]. The Apollonian networks are very useful models capturing simultaneously the remarkable scale-free [35] small-world [36] properties in realistic networks [37], and have found many applications [33]. The deterministic construction of Apollonian networks and their dual graphs allows to treat analytically their topological and combinatorial properties. For both networks, by using the decimation technique for self-similar networks [38], we find their matching number and domination number, and determine the number of different maximum matchings and minimum dominating sets.

2. Constructions and properties of Apollonian networks and extended Tower of Hanoi graphs

In this section, we give a brief introduction to constructions and properties of Apollonian networks and extended Tower of Hanoi graphs—the dual of Apollonian networks.

2.1. Construction means and structural properties of Apollonian networks

The Apollonian networks are generated by an iterative approach [33].

Definition 2.1 Let $\mathcal{A}_n = (\mathcal{V}(\mathcal{A}_n), \mathcal{E}(\mathcal{A}_n))$, $n \geq 0$, denote the Apollonian network after n iterations, with $\mathcal{V}(\mathcal{A}_n)$ and $\mathcal{E}(\mathcal{A}_n)$ being the vertex set and the edge set, respectively. Then, \mathcal{A}_n is constructed as follows:

For $n = 0$, \mathcal{A}_0 is an equilateral triangle.

For $n \geq 1$, \mathcal{A}_n is obtained from \mathcal{A}_{n-1} by performing the following operation: For each existing triangle in \mathcal{A}_{n-1} that was generated at the $(n - 1)$ th iteration, a new vertex is created and connected to the three vertices of this triangle.

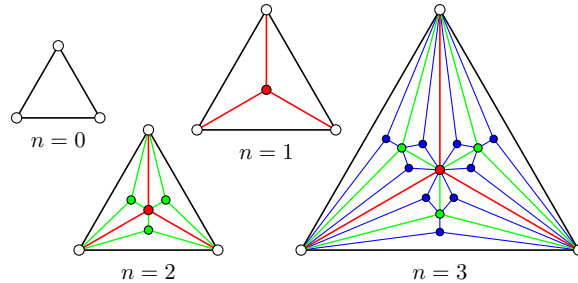

Figure 1: The iteration process for Apollonian networks.

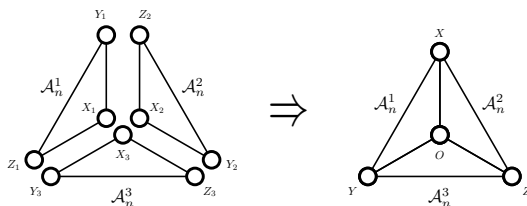

Figure 2: Second construction means for Apollonian networks.

The Apollonian networks are self-similar, which suggests an alternative construction approach [39]. For network \mathcal{A}_n , we call the three initial vertices in \mathcal{A}_0 the outmost vertices denoted by X , Y , and Z , respectively, while call the vertex generated at the first iteration the center vertex, denoted by O . Then, the Apollonian networks can be generated in another way as shown in Fig. 2.

Definition 2.2 Given \mathcal{A}_n , $n \geq 0$, \mathcal{A}_{n+1} is obtained from \mathcal{A}_n by performing the following merging operations:

(i) Joining three copies of \mathcal{A}_n , denoted by \mathcal{A}_n^i , $i = 1, 2, 3$, the three outmost vertices of which are denoted by X_i , Y_i , and Z_i ($i = 1, 2, 3$), with X_i , Y_i , and Z_i in \mathcal{A}_n^i corresponding to X , Y , and Z in \mathcal{A}_n .

(ii) Identifying Y_1 and Z_2 , Y_3 and Z_1 , and Y_2 and Z_3 as the outmost vertex X , Y , and Z of \mathcal{A}_n ; and identifying X_1 , X_2 and X_3 as the center vertex O of \mathcal{A}_{n+1} .

Let V_n and E_n denote, respectively, the number of vertices and edges in \mathcal{A}_n . By construction, V_n and E_n obey relations $V_n = 3V_{n-1} - 5$ and $E_n = 3E_{n-1} - 3$. With the initial conditions $V_1 = 4$ and $E_1 = 6$, we have $V_n = \frac{3^{n+1}+5}{2}$ and $E_n = \frac{3^{n+1}+3}{2}$. Thus, V_n is odd for odd n , and V_n is even for even n .

The Apollonian networks display the striking power-law and small-world characteristics of real networks [33]. Their vertex degree obeys a power-law distribution $P(k) \sim k^{-(1+\ln 3/\ln 2)}$. Their mean shortest distance of all pairs of vertices increases logarithmically with the number of vertices [39]. Thus, the Apollonian networks are good models mimicking real networks, and have received considerable attention from the scientific community [40, 41, 42].

2.2. Constructions and properties of Tower of Hanoi graphs and their extension

In addition to the remarkable scale-free small-world properties, other intrinsic interest of the Apollonian networks is the relevance to the Tower of

Hanoi graphs, that is, the dual graphs of Apollonian networks are extended Tower of Hanoi graphs [40].

Before introducing the dual of Apollonian networks, we first introduce the construction of the Tower of Hanoi graphs, which are derived from the Tower of Hanoi puzzle with n discs [43]. The puzzle consists of n disks of different sizes and three pegs (towers), labeled by 0, 1, and 2, respectively. Initially, all n disks are stacked on peg 0 ordered by size, with the largest on the bottom and the smallest on the top. The task is to move all disks to peg 2 complying with the following Hanoi rules: (i) At each time step only one topmost disk may be moved; (ii) At any moment, no disk can stack on a smaller one.

A convenient and direct representation of the Tower of Hanoi problem is the graph representation. The set of 3^n configurations of the puzzle corresponds to the set of vertices. And the edges specify the legal moves of the game that obey the above rules. The resultant graphs are called the Tower of Hanoi graphs, commonly abbreviated to the Hanoi graphs. Each vertex ξ in the graphs can be labeled by an n -tuple $\xi = (\xi_1 \xi_2 \dots \xi_{n-1} \xi_n)$ or in the regular expression form $\xi = \xi_1 \xi_2 \dots \xi_{n-1} \xi_n$, where $0 \leq \xi_i \leq 2$ represents the peg on which the i th smallest disk resides. Then the labels of any pair of adjacent vertices have the Gray property, that is, they differ in exactly one position [44]. We use $\mathcal{H}_n = (\mathcal{V}(\mathcal{H}_n), \mathcal{E}(\mathcal{H}_n))$ to denote the Hanoi graph of n discs, where $\mathcal{V}(\mathcal{H}_n)$ is the vertex set, and $\mathcal{E}(\mathcal{H}_n)$ is the edge set. Figure 3 shows \mathcal{H}_1 , \mathcal{H}_2 and \mathcal{H}_3 .

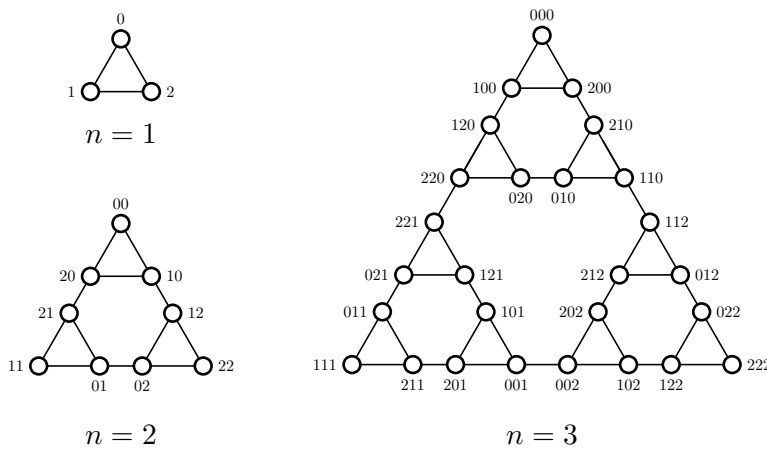

Figure 3: Illustration of Hanoi graphs \mathcal{H}_n , $n = 1, 2, 3$.

In graph \mathcal{H}_n , there are 3^n vertices. The three vertices $00\dots 0$, $11\dots 1$, and $22\dots 2$, are called extreme vertices, each of which corresponds to a state/configuration with all n disks on one of the 3 pegs. Henceforth we use a_n , b_n , and c_n to represent, respectively, the three extreme vertices $00\dots 0$, $11\dots 1$, and $22\dots 2$ in \mathcal{H}_n . Every extreme vertex has 2 neighbors, while the degree of the remaining $3^n - 3$ vertices is 3. Thus, the number of edges in \mathcal{H}_n is $\frac{3^{n+1}-3}{2}$.

Note that \mathcal{H}_{n+1} , $n \geq 1$, can be obtained from three copies of \mathcal{H}_n joined by three edges, each one connecting a pair of extreme vertices from two different replicas of \mathcal{H}_n denoted by \mathcal{H}_n^1 , \mathcal{H}_n^2 and \mathcal{H}_n^3 , see Fig. 4. The properties of the Hanoi graphs have been extensively studied [43, 45].

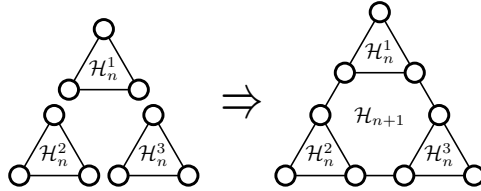

Figure 4: Recursive construction for Hanoi graphs.

The extended Tower of Hanoi graph $\mathcal{S}_n^+ = (\mathcal{V}(\mathcal{S}_n^+), \mathcal{E}(\mathcal{S}_n^+))$, $n \geq 1$ is obtained from \mathcal{H}_n by adding a special vertex s and three edges linking s to the three extreme vertices of \mathcal{H}_n . In graph \mathcal{S}_n^+ , the degree of every vertex is 3. Thus, the number of vertices and edges in \mathcal{S}_n^+ is $V_n = 3^n + 1$ and $E_n = \frac{3^{n+1}+3}{2}$, respectively. For odd n , $3^n + 1$ is a multiple of 4. Fig. 5 shows an extended Tower of Hanoi graph \mathcal{S}_3^+ . It has been shown that extended Tower of Hanoi graph \mathcal{S}_n^+ , $n \geq 1$, is isomorphic to the dual of Apollonian network \mathcal{A}_n [40].

3. Maximum matchings in Apollonian networks and extended Tower of Hanoi graphs

In this section, we study the matching number and the number of maximum matchings in Apollonian networks and extended Tower of Hanoi graphs. We will show that there exist no perfect matchings in Apollonian networks \mathcal{A}_n when $n \geq 3$, but there always exist perfect matchings in extended Tower of Hanoi graphs \mathcal{S}_n^+ for all $n \geq 1$. Moreover, we will determine the number of distinct maximum matchings in both networks.

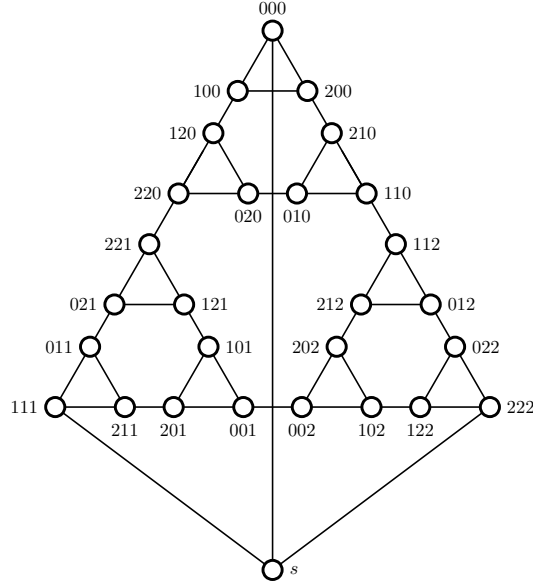

Figure 5: Illustration of an extended Tower of Hanoi graph \mathcal{S}_3^+ .

3.1. Matching number and the number of maximum matchings in Apollonian networks

We first study the matching number and the number of maximum matchings in Apollonian networks.

3.1.1. Matching number

Although for a general graph, its matching number is not easy to determine, for Apollonian network \mathcal{A}_n , we can obtain it by using its self-similar structure. Let β_n be the matching number for \mathcal{A}_n . In order to find β_n , we introduce some useful quantities. According to the number of covered outmost vertices, all matchings of \mathcal{A}_n can be sorted into four classes: Ω_n^k , $k = 0, 1, 2, 3$, with Ω_n^k representing the set of matchings covering exactly k outmost vertices. Let Φ_n^k , $k = 0, 1, 2, 3$ be subset of Ω_n^k consisting of all elements with maximum size (cardinality). Let β_n^k , $k = 0, 1, 2, 3$, denote the size of each matching in Φ_n^k .

Lemma 3.1 *The matching number of network \mathcal{A}_n , $n \geq 1$, satisfies*

$$\beta_n = \max\{\beta_n^0, \beta_n^1, \beta_n^2, \beta_n^3\}.$$

After reducing the problem of determining β_n to computing $\beta_n^0, \beta_n^1, \beta_n^2$ and β_n^3 , we next evaluate their values.

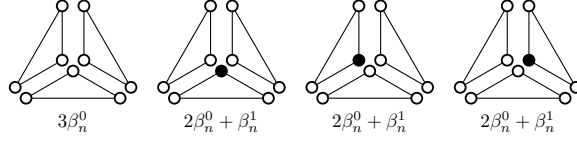

Figure 6: Configurations of matchings for \mathcal{A}_{n+1} belonging to Ω_{n+1}^0 , which contain all matchings in Φ_{n+1}^0 .

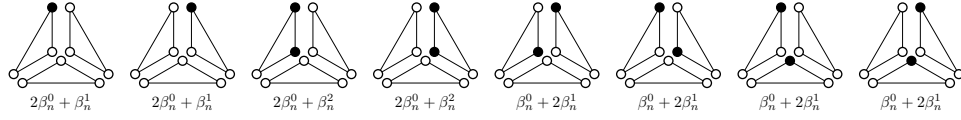

Figure 7: Configurations of matchings for \mathcal{A}_{n+1} belonging to Ω_{n+1}^1 , which contain all matchings in Φ_{n+1}^1 . In view of the symmetry, we only illustrate those matchings of \mathcal{A}_{n+1} , for each of which X is covered, while Y and Z are vacant, but omit matchings that cover only Y (or Z), but not cover X and Z (or X and Y).

Lemma 3.2 For two successive Apollonian networks \mathcal{A}_n and \mathcal{A}_{n+1} , $n \geq 1$, the following relations hold.

$$\beta_{n+1}^0 = \max\{3\beta_n^0, 2\beta_n^0 + \beta_n^1\}, \quad (1)$$

$$\beta_{n+1}^1 = \max\{2\beta_n^0 + \beta_n^1, 2\beta_n^0 + \beta_n^2, \beta_n^0 + 2\beta_n^1\}, \quad (2)$$

$$\beta_{n+1}^2 = \max\{2\beta_n^0 + \beta_n^3, \beta_n^0 + \beta_n^1 + \beta_n^2, 3\beta_n^1, \beta_n^0 + 2\beta_n^1, 2\beta_n^0 + \beta_n^2\}, \quad (3)$$

$$\beta_{n+1}^3 = \max\{\beta_n^0 + \beta_n^1 + \beta_n^2, \beta_n^0 + \beta_n^1 + \beta_n^3, \beta_n^0 + 2\beta_n^2, 3\beta_n^1, 2\beta_n^1 + \beta_n^2\}. \quad (4)$$

Proof. This lemma can be proved graphically. Note that each set Ω_{n+1}^k , $k = 0, 1, 2, 3$, can be further classified into two groups of matchings: one group includes those matchings covering the center vertex in \mathcal{A}_{n+1} , while the other group contains those matchings with the center vertex vacant. According to the classification, Figs. 6, 7, 8 and 9 show, respectively, configurations of matchings for \mathcal{A}_{n+1} belonging to Ω_{n+1}^k , $k = 0, 1, 2, 3$, that comprise all the matchings in Φ_{n+1}^k . In Figs. 6, 7, 8 and 9, only the outmost and center vertices are shown explicitly, with filled circles being covered vertices and empty circles being vacant vertices. From Figs. 6, 7, 8 and 9, we can establish the relations in Eqs. (1), (2), (3) and (4). \square

For small n , β_n^0 , β_n^1 , β_n^2 and β_n^3 can be directly computed by hand. For example, for $n = 1, 2, 3$, we have $(\beta_1^0, \beta_1^1, \beta_1^2, \beta_1^3) = (0, 1, 1, 2)$, $(\beta_2^0, \beta_2^1, \beta_2^2, \beta_2^3) = (1, 2, 3, 3)$, and $(\beta_3^0, \beta_3^1, \beta_3^2, \beta_3^3) = (4, 5, 6, 7)$, respectively. For $n \geq 3$, the following lemma establishes the relations between β_n^0 , β_n^1 , β_n^2 and β_n^3 .

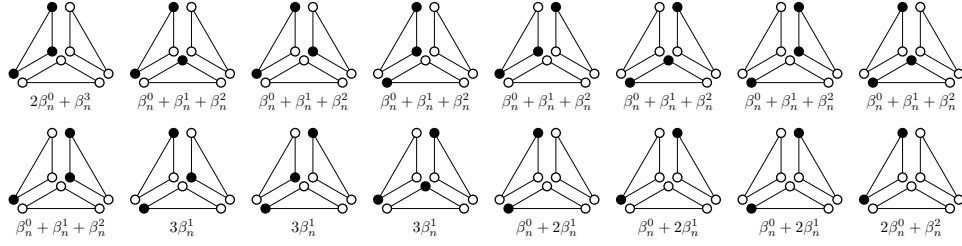

Figure 8: Configurations of matchings for \mathcal{A}_{n+1} belonging to Ω_{n+1}^2 , which contain all matchings in Φ_{n+1}^2 . By symmetry, as in Fig. 7, we only illustrate those matchings of \mathcal{A}_{n+1} , for each of which X and Y are covered, while Z is vacant.

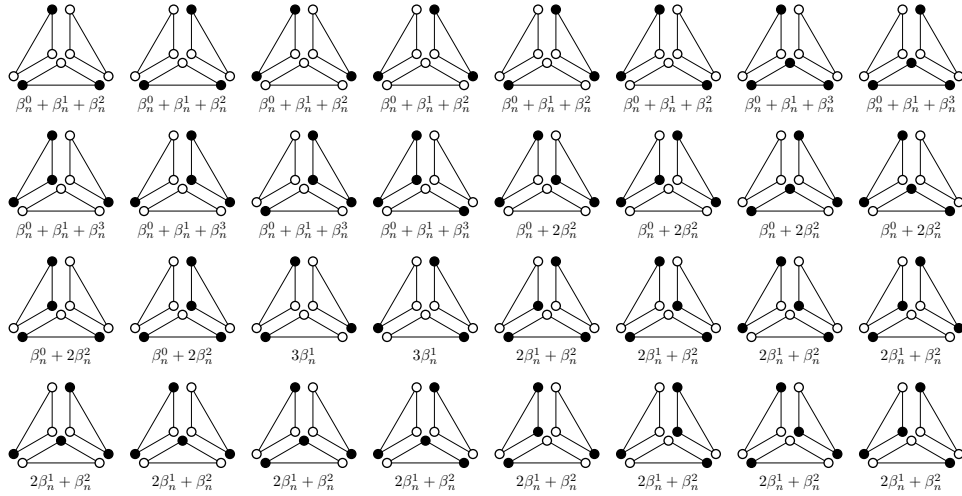

Figure 9: Configurations of matchings for \mathcal{A}_{n+1} belonging to Ω_{n+1}^3 , which contain all matchings in Φ_{n+1}^3 .

Lemma 3.3 For Apollonian network \mathcal{A}_n , $n \geq 3$, quantities $\beta_n^0, \beta_n^1, \beta_n^2, \beta_n^3$, satisfy the following relations:

$$\beta_n^0 + 3 = \beta_n^1 + 2 = \beta_n^2 + 1 = \beta_n^3. \quad (5)$$

Proof. By induction. When $n = 3$, the result is true.

Let us suppose that the relations hold true for $n = k$, i.e., $\beta_k^0 + 3 = \beta_k^1 + 2 = \beta_k^2 + 1 = \beta_k^3$. For $n = k + 1$, by Lemma 3.2 we get $\beta_{k+1}^0 + 3 = \beta_{k+1}^1 + 2 = \beta_{k+1}^2 + 1 = \beta_{k+1}^3$. This completes the proof. \square

Theorem 3.4 For Apollonian network \mathcal{A}_n , $n \geq 3$, its matching number is

$$\beta_n = \frac{3^{n-1} + 5}{2}. \quad (6)$$

Proof. Lemma 3.3 combined with Lemma 3.1 shows that $\beta_n = \beta_n^3$. From Lemma 3.2, we obtain the recursive relation governing β_{n+1}^3 and β_n^3 as $\beta_{n+1}^3 = \max\{\beta_n^0 + \beta_n^1 + \beta_n^2, \beta_n^0 + \beta_n^1 + \beta_n^3, \beta_n^0 + 2\beta_n^2, 3\beta_n^1, 2\beta_n^1 + \beta_n^2\} = 3(\beta_n^3 - 3) + 4$, which, together with the initial value $\beta_3^3 = 7$, is solved to yield $\beta_n = \beta_n^3 = \frac{5 + 3^{n-1}}{2}$. \square

The matching number $\beta_n = \frac{3^{n-1} + 5}{2}$ for Apollonian network \mathcal{A}_n , $n \geq 3$, is much smaller than half the number of vertices $\frac{V_n}{2} = \frac{3^n + 5}{4}$, indicating that no perfect matching exists in \mathcal{A}_n .

Corollary 3.5 For Apollonian network \mathcal{A}_n , $n \geq 3$, the maximum size of a matching covering exactly 0, 1, and 2 outmost vertices, is

$$\beta_n^0 = \frac{3^{n-1} - 1}{2}, \quad (7)$$

$$\beta_n^1 = \frac{3^{n-1} + 1}{2} \quad (8)$$

and

$$\beta_n^2 = \frac{3^{n-1} + 3}{2}, \quad (9)$$

respectively.

Proof. By Eqs. (5) and (6), the result is concluded immediately. \square

3.1.2. Number of maximum matchings

Let τ_n be the number of maximum matchings of \mathcal{A}_n . To determine τ_n , we introduce three more quantities. Let φ_n be the number of matchings of \mathcal{A}_n that are maximum among those matchings for which all the three outmost vertices X , Y , and Z are vacant. Let θ_n be the number of matchings of \mathcal{A}_n that are maximum among those matchings for which X is covered, while Y and Z are vacant. By symmetry, θ_n equals the number of matchings of \mathcal{A}_n that are maximum among those matchings for which Y (Z) is covered, while X and Z (X and Y) are vacant. Let ϕ_n be the number of matchings of \mathcal{A}_n that are maximum among those matchings for which X is vacant, while Y and Z are covered. Obviously, ϕ_n is equal to the number of matchings of \mathcal{A}_n that are maximum among those matchings for which Y (Z) is vacant, while X and Z (X and Y) are covered. For small n , quantities φ_n , θ_n , ϕ_n , and τ_n can be easily determined by using a computer. For example, in the case of $n = 3$, $\varphi_3 = 108$, $\theta_3 = 246$, $\phi_3 = 480$, and $\tau_3 = 738$. For large n , they can be determined recursively as follows.

Theorem 3.6 *For Apollonian network \mathcal{A}_n , $n \geq 3$, the four quantities φ_n , θ_n , ϕ_n , and τ_n can be recursively determined according to the following relations:*

$$\varphi_{n+1} = 3\theta_n\varphi_n^2, \quad (10)$$

$$\theta_{n+1} = 2\phi_n\varphi_n^2 + 4\theta_n^2\varphi_n, \quad (11)$$

$$\phi_{n+1} = \tau_n\varphi_n^2 + 8\phi_n\theta_n\varphi_n + 3\theta_n^3, \quad (12)$$

$$\tau_{n+1} = 6\tau_n\theta_n\varphi_n + 6\varphi_n\phi_n^2 + 12\theta_n^2\phi_n, \quad (13)$$

with initial values $\varphi_3 = 108$, $\theta_3 = 246$, $\phi_3 = 480$, and $\tau_3 = 738$.

Proof. First we show that all matchings listed in Figs. 6, 7, 8, and 9 are truly disjoint for $n \geq 3$. For this purpose, it is sufficient to show that when $n \geq 3$, for any matching \mathcal{M} of \mathcal{A}_{n+1} belonging to Φ_{n+1}^k , $k = 1, 2, 3$, no edge e connecting the outmost vertex X_i and another outmost vertex Y_i (or Z_i) in \mathcal{A}_n^i ($i = 1, 2, 3$) is in \mathcal{M} . This can be proved as follows.

We only prove the case that such an edge e is inexistent in any matching \mathcal{M} in Φ_{n+1}^1 . Otherwise, suppose that the edge e linked to X_i and Y_i is in \mathcal{M} . We distinguish two cases: (i) Z_i is vacant; (ii) Z_i is covered by an edge in \mathcal{A}_n^i . For case (i), all edges belonging to \mathcal{A}_n^i and \mathcal{M} at the same time constitute a matching of \mathcal{A}_n^i that is in Φ_n^2 . If we delete e , then all the remaining edges simultaneously belonging to \mathcal{A}_n^i and \mathcal{M} form a matching of \mathcal{A}_n^i that is in Ω_n^0 . This means $\beta_n^0 + 1 \geq \beta_n^2$, in contradiction with the fact $\beta_n^0 + 2 = \beta_n^2$ obtained in Lemma 3.3. Analogously, we can prove case (ii).

Table 1: The first several values of φ_n , θ_n , ϕ_n , and τ_n .

n	1	2	3	4	5
V_n	4	7	16	43	124
φ_n	1	3	108	8,608,032	8,300,560,282,271,896,633,344
θ_n	1	4	246	37,340,352	71,022,198,720,317,181,345,792
ϕ_n	1	3	480	155,289,960	601,114,712,194,856,725,217,280
τ_n	3	23	738	615,514,464	5,030,805,301,520,123,200,352,256

In a similar argument, we can prove that such an edge e does not exist in any matching \mathcal{M} in Φ_{n+1}^2 or Φ_{n+1}^3 .

Then, to prove Eqs. (10), (11), (12), and (13), it suffices to count all cases that yield maximum matchings in Φ_n^k , $k = 0, 1, 2, 3$, listed in Figs. 6, 7, 8 and 9, respectively.

We here only prove Eq. (12), since the other three equations can be proved in a similar way.

According to Eq. (3) and Lemma 3.3, all the possible configurations of maximum matchings with size β_{n+1}^2 are those having size $2\beta_n^0 + \beta_n^3$, $\beta_n^0 + \beta_n^1 + \beta_n^2$ or $3\beta_n^1$. From Fig. 8, we can see that among all maximum matchings of \mathcal{A}_n covering X and Y but not Z , the number of those with size $2\beta_n^0 + \beta_n^3$, $\beta_n^0 + \beta_n^1 + \beta_n^2$, $3\beta_n^1$ is equal to $\tau_n\varphi_n^2$, $8\phi_n\theta_n\varphi_n$, and $3\theta_n^3$, respectively. By definition of ϕ_{n+1} , Eq. (12) holds. \square

Theorem 3.6 shows that the number of maximum matchings of Apollonian network \mathcal{A}_n can be calculated in $\mathcal{O}(\ln V_n)$ time.

Applying Eqs. (10)-(13), the values of φ_n , θ_n , ϕ_n , and τ_n can be determined for small n as listed in Table 1. However, it is very difficult to obtain closed-form expressions for these quantities.

3.1.3. Asymptotic growth constant for the number of maximum matchings

Table 1 shows that number of maximum matchings τ_n grows exponentially with V_n . Let $Z(\mathcal{A}_n) = \frac{\ln \tau_n}{V_n}$, then we can define a constant describing this exponential growth:

$$Z(\mathcal{A}) = \lim_{n \rightarrow \infty} Z(\mathcal{A}_n) = \lim_{n \rightarrow \infty} \frac{\ln \tau_n}{V_n}. \quad (14)$$

Below we will show that this limit exists. To evaluate the asymptotic growth constant in Eq. (14), we need the following lemma.

Lemma 3.7 *For $n \geq 4$, the quantities φ_n , θ_n , ϕ_n , and τ_n , describing the number of different maximum matchings in Apollonian network \mathcal{A}_n under*

certain conditions, obey the following relation:

$$\varphi_n \leq \theta_n \leq \phi_n \leq \tau_n. \quad (15)$$

Proof. We prove this lemma by induction on n . Table 1 shows that for $n = 4$, the result holds. Let us assume that the lemma is true for $n = k$, that is, $\varphi_k \leq \theta_k \leq \phi_k \leq \tau_k$. For $n = k + 1$, according to induction assumption and Theorem 3.6, we obtain $\varphi_{k+1} \leq \theta_{k+1} \leq \phi_{k+1} \leq \tau_{k+1}$. This completes the proof. \square

In order to estimate the asymptotic growth constant $Z(\mathcal{A}_n)$, we define several ratios: $\alpha_n = \frac{\varphi_n}{\theta_n}$, $\lambda_n = \frac{\tau_n}{\phi_n}$, and $\eta_n = \frac{\theta_n}{\phi_n}$.

Lemma 3.8 *Let $\eta_0 = \frac{2}{3}$ and $\lambda_0 = \frac{12}{11}$. Then for $n \geq 3$, the three ratios α_n , λ_n , and η_n obey following relations: $\alpha_n \downarrow 0$, $\eta_n \leq \eta_0 = \frac{2}{3}$, and $\lambda_n \geq \lambda_0 = \frac{12}{11}$.*

Proof. It is easy to see that $\alpha_n, \lambda_n, \eta_n$ are all constantly positive. By definition,

$$\alpha_{n+1} = \frac{\varphi_{n+1}}{\theta_{n+1}} = \frac{3\theta_n\varphi_n^2}{2\phi_n\varphi_n^2 + 4\theta_n^2\varphi_n} \leq \frac{3}{4} \cdot \frac{\varphi_n}{\theta_n} = \frac{3}{4}\alpha_n.$$

Thus, α_n is a decreasing positive sequence that converges to zero, implying $\alpha_n \downarrow 0$ as $n \rightarrow \infty$.

Next we bound η_n and λ_n . By definitions, we have

$$\eta_{n+1} = \frac{\theta_{n+1}}{\phi_{n+1}} = \frac{2\phi_n\varphi_n^2 + 4\theta_n^2\varphi_n}{\tau_n\varphi_n^2 + 8\phi_n\theta_n\varphi_n + 3\theta_n^3} \leq \frac{2\phi_n\theta_n\varphi_n + 2\phi_n\theta_n\varphi_n + 2\theta_n^3}{8\phi_n\theta_n\varphi_n + 3\theta_n^3} \leq \frac{2}{3}$$

and

$$\begin{aligned} \lambda_{n+1} &= \frac{\tau_{n+1}}{\phi_{n+1}} = \frac{6\tau_n\theta_n\varphi_n + 6\varphi_n\phi_n^2 + 12\theta_n^2\phi_n}{\tau_n\varphi_n^2 + 8\phi_n\theta_n\varphi_n + 3\theta_n^3} \geq \frac{6\tau_n\theta_n\varphi_n + 6\varphi_n\phi_n^2 + 12\theta_n^2\phi_n}{\tau_n\theta_n\varphi_n + 8\phi_n\theta_n^2 + 3\theta_n^2\phi_n} \\ &\geq \frac{6\tau_n\theta_n\varphi_n + 12\theta_n^2\phi_n}{\tau_n\theta_n\varphi_n + 11\theta_n^2\phi_n} \geq \frac{12}{11}, \end{aligned}$$

which, together with the initial values $\eta_3 \approx 0.5125 \leq \frac{2}{3}$ and $\lambda_3 \approx 1.5375 \geq \frac{12}{11}$, show that $\eta_n \leq \eta_0 = \frac{2}{3}$, and $\lambda_n \geq \lambda_0 = \frac{12}{11}$. \square

The above properties of related ratios are given in a loose way. One can provide a tighter bound for λ_n , for example. However, they are enough to find the asymptotic growth constant $Z(\mathcal{A})$.

Theorem 3.9 *For Apollonian network \mathcal{A}_n , $Z(\mathcal{A}_n)$ has a limit when n is sufficiently large, and the asymptotic growth constant for the number of maximum matchings is $Z(\mathcal{A}_n) = 0.43017\dots$*

Proof. By Eqs. (10), (11), (12), (13), we obtain

$$\varphi_{n+1} = \frac{3}{\alpha_n} \varphi_n^3 \quad (16)$$

and

$$\tau_{n+1} = 6\tau_n^3 \left(\frac{\eta_n}{\lambda_n} \cdot \frac{\alpha_n \eta_n}{\lambda_n} + \frac{\alpha_n \eta_n}{\lambda_n^3} + 2 \left(\frac{\eta_n}{\lambda_n} \right)^2 \frac{1}{\lambda_n} \right). \quad (17)$$

Denote $p_n = \frac{3}{\alpha_n}$ and $q = 6 \left(\frac{\alpha_3 \eta_0^2}{\lambda_0^2} + \frac{\alpha_3 \eta_0}{\lambda_0^3} + 2 \left(\frac{\eta_0^2}{\lambda_0^3} \right) \right) \geq 6 \left(\frac{\alpha_n \eta_n^2}{\lambda_n^2} + \frac{\alpha_n \eta_n}{\lambda_n^3} + 2 \left(\frac{\eta_n^2}{\lambda_n^3} \right) \right)$. According to Lemma 3.8, one has $p_n \geq p_{n-1} \geq \dots \geq p_3 = \frac{3}{\alpha_3}$. From Eqs. (16) and (17), we obtain that for $n > m \geq 3$,

$$\varphi_n \geq p_m \varphi_{n-1}^3 \geq p_m p_m^3 \varphi_{n-2}^9 \geq \dots \geq p_m^{\frac{3^{n-m}-1}{2}} \varphi_m^{3^{n-m}}, \quad (18)$$

$$\tau_n \leq \dots \leq q^{\frac{3^{n-m}-1}{2}} \tau_m^{3^{n-m}}. \quad (19)$$

Taking logarithm on both sides of Eqs. (18) and (19) gives rise to

$$\log \varphi_n \geq 3^{n-m} \log \varphi_m + \frac{3^{n-m} - 1}{2} \log p_m, \quad (20)$$

$$\log \tau_n \leq 3^{n-m} \log \tau_m + \frac{3^{n-m} - 1}{2} \log q. \quad (21)$$

Notice that for $n \geq 3$, $\varphi_n \leq \tau_n$ as stated in Lemma 3.7. By definition, $\lim_{n \rightarrow \infty} Z(\mathcal{A}_n) = \lim_{n \rightarrow \infty} \frac{\ln \tau_n}{V_n} = \lim_{n \rightarrow \infty} 2 \frac{\ln \tau_n}{3^n}$. Then, for $n \geq 3$,

$$2 \frac{\log \varphi_m}{3^m} + \frac{\log p_m}{3^m} \leq Z(\mathcal{A}_n) \leq 2 \frac{\log \tau_m}{3^m} + \frac{\log q}{3^m}. \quad (22)$$

Because $\frac{\tau_{n+1}}{\varphi_{n+1}} = 2 \frac{\tau_n}{\varphi_n} + 2 \frac{\phi_n^2}{\theta_n \varphi_n} + 4 \frac{\theta_n \phi_n}{\varphi_n^2} \leq 8 \left(\frac{\tau_n}{\varphi_n} \right)^2$, then $2 \frac{\log \tau_m - \log \varphi_m}{3^m} \rightarrow 0$ as $m \rightarrow \infty$. Therefore, the difference of the leftmost and rightmost sides in Eq. (22) converges to zero as $m \rightarrow \infty$, meaning that $Z(\mathcal{A}_n)$ has a limit when $n > m \rightarrow \infty$.

The convergence of the upper and lower bounds for $Z(\mathcal{A}_n)$ in Eq. (22) is rapid. For example, when m is 7, the difference between the upper and lower bounds is less than 10^{-2} . Note that when $n = 7$, the difference of the exact values for the upper and lower bounds is approximately equal to 0.4×10^{-2} , implying that both bounds are a good approximate of the limit. In other words, even for small m , the upper and lower bounds in Eq. (22) converge to the quoted value $Z(\mathcal{A}_n) = 0.43017\dots$ \square

3.2. Matching number and the number of maximum matchings in extended Tower of Hanoi graphs

We proceed to study the matching number and the number of maximum matchings in extended Tower of Hanoi graphs, the dual of Apollonian networks. We will show that in contrast to Apollonian networks, there always exists a perfect matching in extended Tower of Hanoi graphs. Moreover, we will determine the number of perfect matchings in extended Tower of Hanoi graphs.

3.2.1. Matching number

In the case without inducing confusion, we employ the same notation as those for \mathcal{A}_n studied in the preceding subsection. Let β_n stand for the matching number of \mathcal{S}_n^+ . Let \mathcal{U} be a subset of \mathcal{V} for graph $\mathcal{G} = (\mathcal{V}, \mathcal{E})$, we use $\mathcal{G} \setminus \mathcal{U}$ to denote a subgraph of \mathcal{G} , which is obtained from \mathcal{G} by deleting those vertices in \mathcal{U} and edges adjacent to any vertex in \mathcal{U} . Then, $\mathcal{S}_n^+ \setminus \{s\}$ is isomorphic to \mathcal{H}_n .

Theorem 3.10 *In the extended Tower of Hanoi graph \mathcal{S}_n^+ , $n \geq 2$, a perfect matching always exists. Thus, the matching number of \mathcal{S}_n^+ is*

$$\beta_n = \frac{V_n}{2} = \frac{3^n + 1}{2}. \quad (23)$$

Proof. It suffices to show that the graph \mathcal{S}_n^+ , $n \geq 2$, has a perfect matching. Then the second result immediately follows from the fact that $V_n = 3^n + 1$.

We first prove the existence of a perfect matching in \mathcal{S}_n^+ , $n \geq 2$, by induction on n . When $n = 2$, it is easy to check that a perfect matching exists in \mathcal{S}_2^+ . Thus the result holds for the base case. Assume that for $n = k \geq 2$, there exists a perfect matching in \mathcal{S}_k^+ , which means that there exists at least a perfect matching in the three subgraphs $\mathcal{H}_k \setminus \{a_k\}$, $\mathcal{H}_k \setminus \{b_k\}$, and $\mathcal{H}_k \setminus \{c_k\}$ of \mathcal{H}_k . Then there exists a perfect matching \mathcal{M} in $\mathcal{H}_{k+1} \setminus \{a_{k+1}\}$, $\mathcal{H}_{k+1} \setminus \{b_{k+1}\}$, and $\mathcal{H}_{k+1} \setminus \{c_{k+1}\}$, see Fig. 10, where a_k^i , b_k^i , and c_k^i denote the extreme vertices of \mathcal{H}_k^i , $i = 1, 2, 3$, forming \mathcal{H}_{k+1} . By adding to \mathcal{M} the edge connected the special vertex s and the vacant extreme vertex a_{k+1} , b_{k+1} , or c_{k+1} , leads to a perfect matching of \mathcal{S}_{k+1}^+ , as shown in Fig. 10. \square

3.2.2. Number of perfect matchings

Let β_n^k , $k = 0, 1, 2, 3$, be the maximum size of matchings of the subgraph of \mathcal{H}_n obtained from \mathcal{H}_n by deleting exactly k extreme vertices and the edges attaching to these k extreme vertices. For any matching \mathcal{M} of \mathcal{H}_n with at least one vacant extreme vertex, we can obtain a matching \mathcal{M}' of \mathcal{S}_n^+ from

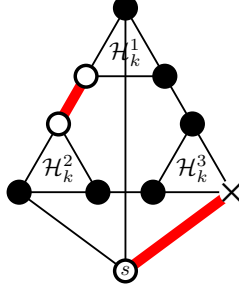

Figure 10: Illustration of existence of a perfect matching in \mathcal{S}_{k+1}^+ for $k \geq 2$. The cross vertex denotes the removed extreme vertex c_{k+1} from \mathcal{H}_{k+1} . A perfect matching for $\mathcal{H}_{k+1} \setminus \{c_{k+1}\}$ can be obtained by adding one thick edges linked to the two extreme vertices c_k^1 in \mathcal{H}_k^1 and c_k^2 and \mathcal{H}_k^2 to the union of perfect matchings for $\mathcal{H}_k^1 \setminus \{c_k^1\}$, $\mathcal{H}_k^2 \setminus \{c_k^2\}$, and $\mathcal{H}_k^3 \setminus \{c_k^3\}$. Adding to a perfect matching of $\mathcal{H}_{k+1} \setminus \{c_{k+1}\}$ one thick edge connecting to the extreme vertex c_{k+1} and the special vertex s gives a perfect matching for \mathcal{S}_{k+1}^+ .

\mathcal{M} by adding to it an edge adjacent to a vacant extreme vertex and the special vertex s .

Note that for any perfect matching \mathcal{M}' in \mathcal{S}_{n+1}^+ , the number of matching edges in its subgraph \mathcal{H}_n^i , $i = 1, 2, 3$, must be β_n^0 or β_n^2 . Otherwise, we suppose that in some \mathcal{H}_n^i , the number of matching edges is β_n^1 or β_n^3 , then there must be one vacant non-extreme vertex in \mathcal{H}_n^i , meaning that \mathcal{M}' cannot be a perfect matching of \mathcal{S}_{n+1}^+ .

Next, we show that in graph $\mathcal{H}_n \setminus \{a_n, b_n, c_n\}$, any matching with size β_n^0 is indeed a perfect matching.

Lemma 3.11 *For $n \geq 2$, there exists a perfect matching in the subgraph $\mathcal{H}_n \setminus \{a_n, b_n, c_n\}$ of the extended Tower of Hanoi graph \mathcal{H}_n , and its matching number is*

$$\beta_n^0 = \frac{3^n - 3}{2}. \quad (24)$$

Proof. We prove this lemma by induction on n . When $n = 2$, the three edges connecting the three pairs of extreme vertices in \mathcal{H}_1^i , $i = 1, 2, 3$, form a perfect matching of $\mathcal{H}_2 \setminus \{a_2, b_2, c_2\}$. Thus, the base case holds. Suppose that for $n = k \geq 2$, there exists a perfect matching in $\mathcal{H}_k \setminus \{a_k, b_k, c_k\}$. Then for $n = k + 1$, we can obtain a perfect matching of $\mathcal{H}_{k+1} \setminus \{a_{k+1}, b_{k+1}, c_{k+1}\}$ by adding to the perfect matchings of $\mathcal{H}_k^i \setminus \{a_k^i, b_k^i, c_k^i\}$, $i = 1, 2, 3$, three edges connecting three pairs of extreme vertices in \mathcal{H}_k^i . See Fig. 11. Then, the number of edges in a perfect matching of $\mathcal{H}_n \setminus \{a_n, b_n, c_n\}$ is $\beta_n^0 = \frac{3^n - 3}{2}$.

□

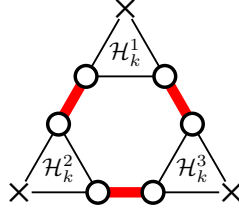

Figure 11: Illustration of existence of a perfect matching in $\mathcal{H}_{k+1} \setminus \{a_{k+1}, b_{k+1}, c_{k+1}\}$ for $k \geq 2$. The cross vertices denote those removed extreme vertices from \mathcal{H}_{k+1} .

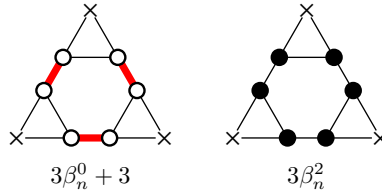

Figure 12: Configurations of maximum matchings for $\mathcal{H}_{n+1} \setminus \{a_{n+1}, b_{n+1}, c_{n+1}\}$.

Let φ_n be the number of maximum matchings of $\mathcal{H}_n \setminus \{a_n, b_n, c_n\}$. Let ϕ_n be the number of maximum matchings of $\mathcal{H}_n \setminus \{a_n\}$, which is equal to the number of maximum matchings of $\mathcal{H}_n \setminus \{b_n\}$ or $\mathcal{H}_n \setminus \{c_n\}$.

Lemma 3.12 *For the Tower of Hanoi graph \mathcal{H}_n , $n \geq 2$, the quantities φ_n and ϕ_n satisfy the following relations:*

$$\varphi_{n+1} = \varphi_n^3 + \phi_n^3, \quad (25)$$

$$\phi_{n+1} = \phi_n^2 \varphi_n + \phi_n^3. \quad (26)$$

Proof. We prove this lemma graphically. Fig. 12 provides all configurations of maximum matchings in $\mathcal{H}_{n+1} \setminus \{a_{n+1}, b_{n+1}, c_{n+1}\}$ that contribute to φ_{n+1} . Columns 1 and 4 in Fig. 13 provide all configurations of maximum matchings in $\mathcal{H}_{n+1} \setminus \{a_{n+1}\}$ that contribute to ϕ_{n+1} .

Here we only given an explanation for Eq. (25), while Eq. (26) can be accounted for analogously.

Fig. 12 shows that in graph $\mathcal{H}_{n+1} \setminus \{a_{n+1}, b_{n+1}, c_{n+1}\}$, all possible configurations of maximum matchings with size β_{n+1}^0 are those having size $3\beta_n^0 + 3$ or $3\beta_n^2$. From Fig. 12, we can see that the number of all maximum matchings with size $3\beta_n^0 + 3$ and $3\beta_n^2$ is equal to φ_n^3 and ϕ_n^3 , respectively. By definition of φ_{n+1} , Eq. (25) holds. \square

The recursive relations stated in Lemma 3.12 allow to determine explicitly the quantities φ_n and ϕ_n .

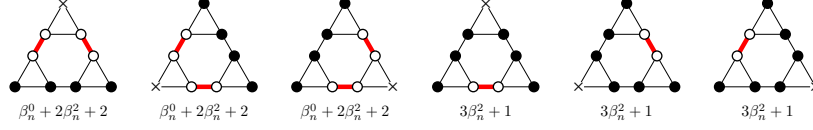

Figure 13: Configurations of maximum matchings for $\mathcal{H}_{n+1} \setminus \{a_{n+1}\}$, $\mathcal{H}_{n+1} \setminus \{b_{n+1}\}$, and $\mathcal{H}_{n+1} \setminus \{c_{n+1}\}$.

Lemma 3.13 For the Tower of Hanoi graph \mathcal{H}_n , $n \geq 2$,

$$\varphi_n = \phi_n = 2^{\frac{3^n - 1 - 1}{2}}. \quad (27)$$

Proof. Eqs. (25) and (26) implies $\varphi_{n+1} - \phi_{n+1} = \varphi_n(\varphi_n^2 - \phi_n^2)$, which together with $\varphi_2 = \phi_2 = 2$ shows that $\varphi_n = \phi_n$ for all $n \geq 2$. Then, considering Eq. (25), we get the recursive relation for φ_n as $\varphi_{n+1} = 2\varphi_n^3$ that can be easily solved to yield $\varphi_n = \phi_n = 2^{\frac{3^n - 1 - 1}{2}}$. \square

Theorem 3.14 The number of perfect matchings in the extended Tower of Hanoi graph \mathcal{S}_n^+ , $n \geq 2$, is $3 \cdot 2^{\frac{3^n - 1 - 1}{2}}$.

Proof. Because for any perfect matching of \mathcal{S}_n^+ , the special vertex s is covered simultaneously with an extreme vertex in \mathcal{H}_n , there is a one-to-one correspondence between perfect matchings of \mathcal{S}_n^+ and perfect matchings in $\mathcal{H}_n \setminus \{a_n\}$, $\mathcal{H}_n \setminus \{b_n\}$ or $\mathcal{H}_n \setminus \{c_n\}$. Thus, the number of perfect matchings in \mathcal{S}_n^+ is $3\phi_n = 3 \cdot 2^{\frac{3^n - 1 - 1}{2}}$. \square

It should be mentioned that the problem of all matchings in the Tower of Hanoi graphs has been previously studied [46]. However, here we address the problem of perfect matching in the Hanoi graphs with one extreme vertex removed. Moreover, our technique is different from that in [46], but is partially similar to those in [47] and [48].

4. Domination number and the number of minimum dominating sets in Apollonian Networks and extended Tower of Hanoi graphs

In this section, we study the domination number and the number of minimum dominating sets in Apollonian Networks and extended Tower of Hanoi graphs.

4.1. *Domination number and the number of minimum dominating sets in Apollonian Networks*

We first address the domination number and the number of minimum dominating sets in Apollonian networks, by using their structural self-similarity.

4.1.1. *Domination number*

Let γ_n be the domination number of \mathcal{A}_n . All dominating sets of \mathcal{A}_n can be sorted into four classes: Θ_n^0 , Θ_n^1 , Θ_n^2 , and Θ_n^3 , where Θ_n^k , $k = 0, 1, 2, 3$, denotes the set of those dominating sets, each containing exactly k outmost vertices. Let Υ_n^k , $k = 0, 1, 2, 3$, be the subsets of Θ_n^k , each of which has the smallest cardinality, denoted by γ_n^k . The dominating sets in Υ_{n+1}^k , $k = 0, 1, 2, 3$, can be further sorted into two groups: in one group, each dominating set contains the center vertex, while in the other group, every dominating set excludes the center vertex.

Lemma 4.1 *The domination number of Apollonian network \mathcal{A}_n , $n \geq 3$, is $\gamma_n = \min\{\gamma_n^0, \gamma_n^1, \gamma_n^2, \gamma_n^3\}$.*

Thus, the problem of determining γ_n is reduced to evaluating $\gamma_n^0, \gamma_n^1, \gamma_n^2, \gamma_n^3$. We next estimate these quantities.

Lemma 4.2 *For Apollonian network \mathcal{A}_n , $n \geq 3$,*

$$\gamma_{n+1}^0 = \min\{3\gamma_n^0, 3\gamma_n^1 - 2\}, \quad (28)$$

$$\gamma_{n+1}^1 = \min\{2\gamma_n^1 - 1, 2\gamma_n^2 + \gamma_n^1 - 3\}, \quad (29)$$

$$\gamma_{n+1}^2 = \min\{\gamma_n^2 + 2\gamma_n^1 - 2, \gamma_n^3 + 2\gamma_n^2 - 4\}, \quad (30)$$

$$\gamma_{n+1}^3 = \min\{3\gamma_n^2 - 3, 3\gamma_n^3 - 5\}. \quad (31)$$

Proof. By definition, γ_{n+1}^k , $k = 0, 1, 2, 3$, is the cardinality of a set in Υ_{n+1}^k . The four sets Υ_{n+1}^k , $k = 0, 1, 2, 3$, can be iteratively constructed from Υ_n^0 , Υ_n^1 , Υ_n^2 , and Υ_n^3 , as will be shown below. Then, γ_{n+1}^k , $k = 0, 1, 2, 3$, can be derived from $\gamma_n^0, \gamma_n^1, \gamma_n^2$, and γ_n^3 .

Eqs. (28)-(31) can all be proved graphically. We first prove Eq. (28).

By Definition 2.2, \mathcal{A}_{n+1} consists of three copies of \mathcal{A}_n , \mathcal{A}_n^i with $i = 1, 2, 3$. By definition, for an arbitrary dominating set \mathcal{D} belonging to Υ_{n+1}^0 , the three outmost vertices of \mathcal{A}_{n+1} are not in \mathcal{D} , implying that the outmost vertices Y_i and Z_i of \mathcal{A}_n^i , $i = 1, 2, 3$, do not belong to \mathcal{D} , see Fig. 2. Then, we can construct \mathcal{D} from Υ_n^0 , Υ_n^1 , Υ_n^2 , and Υ_n^3 by considering whether the outmost vertices X_i of \mathcal{A}_n^i , $i = 1, 2, 3$, are in \mathcal{D} or not. Fig. 14 illustrates all possible

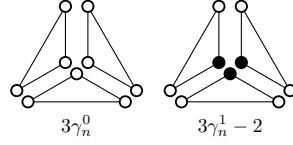

Figure 14: All possible configurations of dominating sets in Θ_{n+1}^0 for \mathcal{A}_{n+1} , which contains the elements in Υ_{n+1}^0 .

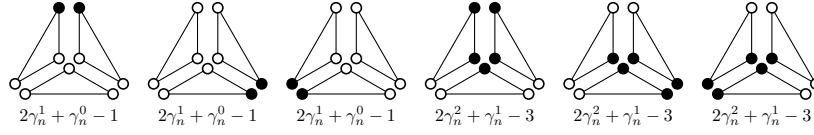

Figure 15: All possible configurations of dominating sets in Θ_{n+1}^1 for \mathcal{A}_{n+1} , which contains the elements in Υ_{n+1}^1 .

configurations of dominating sets in Θ_{n+1}^0 that contains all dominating sets in Υ_{n+1}^0 . In Fig. 14, only the outmost vertices of \mathcal{A}_n^i , $i = 1, 2, 3$, are shown, with solid vertices being in the dominating sets, while open vertices not. From Fig. 14, we obtain

$$\gamma_{n+1}^0 = \min\{3\gamma_n^0, 3\gamma_n^1 - 2\}.$$

Similarly, we can prove Eqs. (29), (30), and (31). In Figs. 15, 16, and 17, we provide graphical representations of them. \square

For small n , γ_n^0 , γ_n^1 , γ_n^2 , and γ_n^3 can be determined by hand. For example, for \mathcal{A}_n , $n = 1, 2, 3$, we have $(\gamma_1^0, \gamma_1^1, \gamma_1^2, \gamma_1^3) = (1, 1, 2, 3)$, $(\gamma_2^0, \gamma_2^1, \gamma_2^2, \gamma_2^3) = (1, 2, 2, 3)$, and $(\gamma_3^0, \gamma_3^1, \gamma_3^2, \gamma_3^3) = (3, 3, 3, 3)$.

For $n \geq 3$, these quantities follow some relation as stated in the following lemma.

Lemma 4.3 *For Apollonian network \mathcal{A}_n , $n \geq 3$, the four quantities γ_n^0 , γ_n^1 , γ_n^2 , and γ_n^3 obey the following relations:*

$$\gamma_n^0 \geq \gamma_n^1 \geq \gamma_n^2 \geq \gamma_n^3. \quad (32)$$

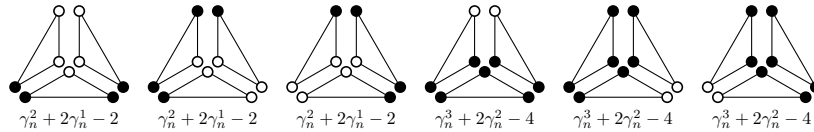

Figure 16: All possible configurations of dominating sets in Θ_{n+1}^2 for \mathcal{A}_{n+1} , which contains the elements in Υ_{n+1}^2 .

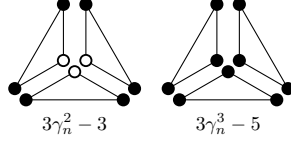

Figure 17: All possible configurations of dominating sets in Θ_{n+1}^3 for \mathcal{A}_{n+1} , which contains the elements in Υ_{n+1}^3 .

Proof. We prove this lemma by induction on n . When $n = 3$, $\gamma_3^0 = \gamma_3^1 = \gamma_3^2 = \gamma_3^3 = 3$. Thus, the basis step holds.

Let us suppose that the relation holds true for $n = k$, that is, $\gamma_k^0 \geq \gamma_k^1 \geq \gamma_k^2 \geq \gamma_k^3$. Then, from Eq. (28), we obtain

$$\gamma_{k+1}^0 = \min\{3\gamma_k^0, 3\gamma_k^1 - 2\} = 3\gamma_k^1 - 2.$$

Analogously, we can derive

$$\begin{aligned}\gamma_{k+1}^1 &= 2\gamma_k^2 + \gamma_k^1 - 3, \\ \gamma_{k+1}^2 &= \gamma_k^3 + 2\gamma_k^2 - 4, \\ \gamma_{k+1}^3 &= 3\gamma_k^3 - 5.\end{aligned}$$

Comparing the above-obtained four relations and using induction hypothesis $\gamma_k^0 \geq \gamma_k^1 \geq \gamma_k^2 \geq \gamma_k^3$, we arrive at $\gamma_{k+1}^0 \geq \gamma_{k+1}^1 \geq \gamma_{k+1}^2 \geq \gamma_{k+1}^3$. This completes the proof. \square

Theorem 4.4 *The domination number of Apollonian network \mathcal{A}_n , $n \geq 3$, is*

$$\gamma_n = \frac{3^{n-3} + 5}{2}. \quad (33)$$

Proof. Lemmas 4.1 and 4.3 imply that $\gamma_n = \gamma_n^3$. Then, we have the following recursion relation for

$$\gamma_{n+1} = \gamma_{n+1}^3 = 3\gamma_n^3 - 5 = 3\gamma_n - 5. \quad (34)$$

With the initial value $\gamma_3 = 3$, this relation is solved to yield $\gamma_n = \frac{3^{n-3} + 5}{2}$. \square

Therefore, in a large Apollonian network \mathcal{A}_n , $n \rightarrow \infty$, $\frac{\gamma_n}{V_n} = \frac{3^{n-3} + 5}{3^{n+5}} \approx \frac{1}{27}$.

Corollary 4.5 *For Apollonian network \mathcal{A}_n , $n \geq 3$,*

$$\gamma_n^0 = \frac{3^{n-3} + 3 \cdot 2^{n-2} - 1}{2}, \quad (35)$$

$$\gamma_n^1 = \frac{3^{n-3} + 2^{n-1} + 1}{2}, \quad (36)$$

$$\gamma_n^2 = \frac{3^{n-3} + 2^{n-2} + 3}{2}. \quad (37)$$

Proof. By Lemmas 4.2 and 4.3 and Eq. (33), the result is concluded immediately. \square

4.1.2. Number of minimum dominating sets

Let w_n be the number of minimum dominating sets in Apollonian network \mathcal{A}_n .

Theorem 4.6 *The Apollonian network \mathcal{A}_n , $n \geq 4$, has a unique minimum domination set, that is, $w_n = 1$.*

Proof. Equation (34) and Fig. 17 indicate that for $n \geq 4$, any minimum dominating set of \mathcal{A}_{n+1} is the union of three minimum dominating sets in Υ_n^3 , of the three copies of \mathcal{A}_n (i.e., \mathcal{A}_n^1 , \mathcal{A}_n^2 , and \mathcal{A}_n^3) forming \mathcal{A}_{n+1} , with their identified outmost vertices being counted only four times. Since the minimum dominating set of \mathcal{A}_4 is unique, for $n \geq 4$, there is a unique minimum dominating set in \mathcal{A}_n . In fact, the unique dominating set of \mathcal{A}_n , $n \geq 4$, is the set of all vertices of \mathcal{A}_{n-2} . \square

The Apollonian network \mathcal{A}_n has some interesting properties. For example, a dominating set of any of its subgraphs, say \mathcal{A}'_n , obtained from \mathcal{A}_n by deleting one or several outmost vertices is also a dominating set of the whole network \mathcal{A}_n . This can be explained as follows. For a new neighboring vertex (with degree 3) of an outmost vertex in \mathcal{A}_n not in its subgraph \mathcal{A}'_n , it must be generated at iteration n and its other neighbors are also neighbors of the outmost vertex. Thus, any dominating set of the subgraph \mathcal{A}'_n must simultaneously dominate the new vertex and its neighboring outmost vertex. Therefore, any dominating set of \mathcal{A}'_n is also a dominating set of \mathcal{A}_n .

In addition to the number of minimum dominating sets in Apollonian network \mathcal{A}_n itself, the number of minimum dominating sets in some of its subgraphs can also be determined explicitly. Let x_n be the number of minimum dominating sets of $\mathcal{A}_n \setminus \{X, Y, Z\}$, let y_n be the number of minimum dominating sets of $\mathcal{A}_n \setminus \{X, Y\}$, which is equal to the number of minimum dominating sets of $\mathcal{A}_n \setminus \{Y, Z\}$ or $\mathcal{A}_n \setminus \{Z, X\}$, and let z_n be the number of minimum dominating sets of $\mathcal{A}_n \setminus \{X\}$, which equals the number of dominating sets of $\mathcal{A}_n \setminus \{Y\}$ or $\mathcal{A}_n \setminus \{Z\}$.

Lemma 4.7 *For the Apollonian network \mathcal{A}_n , $n \geq 4$, $x_n = 8$, $y_n = 2$, and $z_n = 1$.*

Proof. Figs. 14, 15, and 16 show that the quantities x_n , y_n , and z_n satisfy the following relations:

$$x_{n+1} = y_n^3, \quad (38)$$

$$y_{n+1} = z_n^2 y_n, \quad (39)$$

and

$$z_{n+1} = w_n z_n^2. \quad (40)$$

Using $x_3 = 1$, $y_3 = 2$, $z_3 = 1$, and $w_n = 1$ for all $n \geq 3$, the above-obtained relations in Eqs. (38), (39), and (40) are solved to give the result. \square

4.2. Domination number and the number of minimum dominating sets in extended Tower of Hanoi graphs

We are now in a position to study the domination number and the number of minimum dominating sets in extended Tower of Hanoi graphs.

4.2.1. Domination number

Let γ_n denote the domination number of the extended Tower of Hanoi graph \mathcal{S}_n^+ , $n \geq 1$.

Theorem 4.8 *The domination number of the extended Tower of Hanoi graph \mathcal{S}_n^+ , $n \geq 1$, is*

$$\gamma_n = \begin{cases} \frac{3^n + 1}{4}, & n \text{ odd,} \\ \frac{3^n + 3}{4}, & n \text{ even.} \end{cases}$$

Proof. The proof technique is similar to that in [49]. The basic idea is to construct a minimum dominating set \mathcal{D} of \mathcal{H}_n ($n \geq 1$) with size γ_n , and then show that \mathcal{D} is also a minimum dominating set of \mathcal{S}_n^+ .

For a vertex $\xi = \xi_1 \xi_2 \dots \xi_{n-1} \xi_n$ in \mathcal{H}_n , Let f_ξ^k denote the number of terms in the label for ξ that are equal to k for $k = 0, 1$, or 2 . Define \mathcal{D} as a subset of vertices in \mathcal{H}_n such that $\mathcal{D} = \{\xi \in \mathcal{V}(\mathcal{H}_n) | f_\xi^0 \text{ and } f_\xi^1 \text{ are even}\}$. Then, for even n , all the three extreme vertices are in \mathcal{D} ; while for odd n , only extreme vertex c_n is in \mathcal{D} . By definition, for any pair of nearest vertices in \mathcal{D} , their distance is exactly 3, thus they have no neighbors in common [49]. Moreover, any vertex in \mathcal{D} has 3 neighbors, except the extreme vertices, each having only two neighbors in \mathcal{H}_n . Note that any other vertex in $\mathcal{V}(\mathcal{H}_n) \setminus \mathcal{D}$ is adjacent to exactly one vertex in \mathcal{D} [49]. Therefore, the number of vertices in \mathcal{D} is $|\mathcal{D}| = \frac{3^n + 3}{4}$ for even n or $|\mathcal{D}| = \frac{3^n + 1}{4}$ for odd n . Hence \mathcal{D} is a dominating set of \mathcal{H}_n .

We proceed to show that \mathcal{D} is also a minimum dominating set of \mathcal{H}_n . Since all vertices of \mathcal{H}_n have a degree 3, except the three extreme vertices (each with a degree 2), every vertex in a minimum dominating set can dominate at most 4 vertices including itself. As a result, any dominating set of \mathcal{H}_n contains at least $\lceil \frac{3^n}{4} \rceil = \frac{3^n+1}{4}$ vertices for even n , or $\lceil \frac{3^n}{4} \rceil = \frac{3^n+3}{4}$ vertices for odd n . Thus, \mathcal{D} is actually a minimum dominating set of \mathcal{H}_n . Considering that \mathcal{D} includes at least one extreme vertex, which is a neighbor of the special vertex s in \mathcal{S}_n^+ , which implies that \mathcal{D} is a dominating set of \mathcal{S}_n^+ . Because in any dominating set of \mathcal{S}_n^+ , there are at least $\lceil \frac{3^n+1}{4} \rceil = \frac{3^n+1}{4}$ vertices for even n , or $\lceil \frac{3^n+1}{4} \rceil = \frac{3^n+3}{4}$ vertices for odd n , \mathcal{D} is also a minimum dominating set of \mathcal{S}_n^+ . This completes the proof. \square

Theorem 4.8 shows that the domination number of the extended Tower of Hanoi graph \mathcal{S}_n^+ , $n \geq 1$, is equivalent to that of the corresponding Tower of Hanoi graph \mathcal{H}_n [49, 50, 51, 52].

4.2.2. Number of minimum dominating sets in \mathcal{S}_n^+ for odd n

We will show that except for the domination number, the number of minimum dominating sets in the extended Tower of Hanoi graph \mathcal{S}_n^+ , $n \geq 1$, can also be determined explicitly, at least for odd n . Hereafter, we will only consider the number of minimum dominating sets in \mathcal{S}_n^+ for odd n .

Given a minimum dominating set \mathcal{D} of \mathcal{S}_n^+ , the vertices of any subset $\Delta \subset \mathcal{V}(\mathcal{S}_n^+)$ can be classified into three types. For any vertex $y \in \Delta$, either y is in \mathcal{D} , or y is adjacent to a vertex in \mathcal{D} that is a disjoint union of $\mathcal{D} \cap \Delta$ and $\mathcal{D} \setminus \Delta$. If $y \in \mathcal{D}$, we say y is of type I; if y is adjacent to a vertex in $\mathcal{D} \cap \Delta$, then y is of type D; otherwise y is adjacent to a vertex in $\mathcal{D} \setminus \Delta$, then y is of type C. According to this definition, for an arbitrary minimum domination set \mathcal{D} of \mathcal{S}_n^+ , if we set $\Delta = \mathcal{V}(\mathcal{H}_n)$, then the possible types of the three extreme vertices a_n , b_n , and c_n of \mathcal{H}_n are in turn D-D-I, D-I-D, I-D-D, or C-C-C.

Note that \mathcal{H}_{n+2} consists of nine copies of \mathcal{H}_n , denoted as \mathcal{H}_n^i , $i = 1, 2, \dots, 9$. For any minimum dominating set \mathcal{D}_2 of \mathcal{S}_{n+2}^+ , which is obtained from \mathcal{H}_{n+2} by adding a special vertex s connected to the three extreme vertices of \mathcal{H}_{n+2} , if we set $\Delta = \mathcal{V}(\mathcal{H}_n^i)$, then with respect to \mathcal{D}_2 , the corresponding three extreme vertices in \mathcal{H}_n^i could possibly belong to one of three types: (i) C-C-C, (ii) I-D-D, (iii) I-I-C, because any vertex in \mathcal{D}_2 dominates exactly four vertices including itself, each without being dominated by any other vertex in \mathcal{D}_2 . However, the type I-I-C actually does not exist as stated in the following lemma.

Lemma 4.9 *For any minimum domination set of \mathcal{S}_{n+2}^+ with odd $n \geq 1$, the*

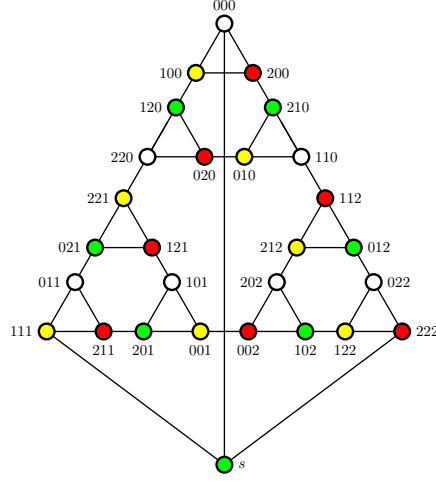

Figure 18: Illustration of all four minimum dominating sets and four different disjoint classes of vertices or in \mathcal{S}_3^+ . The vertices with the same color form a class or a minimum dominating set.

type I-I-C for the three extreme vertices in any \mathcal{H}_n^i , $i = 1, 2, \dots, 9$, is not possible to exist.

Proof. Let \mathcal{D}_2 be a minimum dominating set of \mathcal{S}_{n+2}^+ . As shown above, if we restrict $\Delta = \mathcal{V}(\mathcal{H}_{n+2})$, then for the three extreme vertices of \mathcal{H}_{n+2} , either all of them are of type C, or one extreme vertex is of type I, while the other two are of type D. For any pair of adjacent extreme vertices belonging to two different copies \mathcal{H}_n^i , their types under $\Delta = \mathcal{V}(\mathcal{H}_n^i)$ obey the following two rules: (1) Type C is adjacent to only type I, and vice versa; (2) D is adjacent to only D. According to these rules, by induction we can prove that in \mathcal{S}_{n+2}^+ , the type (iii) I-I-C for the three extreme vertices in any \mathcal{H}_n^i actually doesn't exist.

For $n = 1$, it is easy to check by hand that there are only four minimum dominating sets in \mathcal{S}_3^+ , see Fig. 18, where type I-I-C is not existent. Assume that the result holds for $n - 2$ ($n \geq 3$), i.e. for any minimum dominating set in \mathcal{S}_n^+ there is no type I-I-C in any \mathcal{H}_{n-2}^i , $i = 1, 2, \dots, 9$, when setting $\Delta = \mathcal{V}(\mathcal{H}_{n-2}^i)$. For n , by contradiction, suppose that type I-I-C exists for the three extreme vertices of a subgraph \mathcal{H}_n^i of \mathcal{S}_{n+2}^+ , Fig. 19 shows that the extreme vertex \star of the topmost $\mathcal{H}_{n-2}^{i'}$ as a constituent of some \mathcal{H}_n^i should be of type I. This is not possible to exist, since for this case, at least two extreme vertices in the topmost $\mathcal{H}_{n-2}^{i'}$ are of type I, which is in contradiction to the induction hypothesis. This completes the lemma. \square

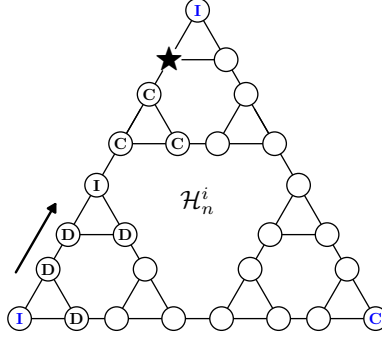

Figure 19: Types of extreme vertices for a certain \mathcal{H}_n^i as one of the nine constituents of \mathcal{H}_{n+2} . Assume that the types of three extreme vertices are assumed to be I-I-C. According to the rules governing the types of adjacent extreme vertices belonging to two different copies $\mathcal{H}_{n-2}^{i'}$, $i' = 1, 2, \dots, 9$, the extreme vertex \star of the topmost $\mathcal{H}_{n-2}^{i'}$ cannot have a legal type, when we label the vertex types along the arrow.

We now determine all minimum dominating sets in \mathcal{S}_n^+ for odd n . Note that for odd n , all vertices of \mathcal{S}_n^+ can be categorized into four disjoint classes:

$$\mathcal{X}_n^1 = \{\xi \in \mathcal{V}(\mathcal{H}_n) \mid f_\xi^0 \text{ and } f_\xi^1 \text{ are even}\},$$

$$\mathcal{X}_n^2 = \{\xi \in \mathcal{V}(\mathcal{H}_n) \mid f_\xi^0 \text{ and } f_\xi^2 \text{ are even}\},$$

$$\mathcal{X}_n^3 = \{\xi \in \mathcal{V}(\mathcal{H}_n) \mid f_\xi^1 \text{ and } f_\xi^2 \text{ are even}\},$$

$$\mathcal{X}_n^4 = \{\xi \in \mathcal{V}(\mathcal{H}_n) \mid f_\xi^0, f_\xi^1 \text{ and } f_\xi^2 \text{ are odd}\} \cup \{s\},$$

satisfying that $\mathcal{V}(\mathcal{S}_n^+) = \mathcal{X}_n^1 \cup \mathcal{X}_n^2 \cup \mathcal{X}_n^3 \cup \mathcal{X}_n^4$ and $\mathcal{X}_n^1 \cap \mathcal{X}_n^2 \cap \mathcal{X}_n^3 \cap \mathcal{X}_n^4 = \emptyset$. Then $|\mathcal{X}_n^1| = |\mathcal{X}_n^2| = |\mathcal{X}_n^3| = |\mathcal{X}_n^4| = \frac{3^n+1}{4}$. Fig. 18 illustrates the four distinct classes of vertices in \mathcal{S}_3^+ .

Theorem 4.10 *For each odd $n \geq 1$, there are exactly four distinct minimum dominating sets, \mathcal{X}_n^1 , \mathcal{X}_n^2 , \mathcal{X}_n^3 , and \mathcal{X}_n^4 , in the extended Tower of Hanoi graph \mathcal{S}_n^+ .*

Proof. We first prove that each \mathcal{X}_n^k , $k = 1, 2, 3, 4$, is a minimum dominating set of \mathcal{S}_n^+ , following a similar approach in [49]. By definition, the distance between any pair of nearest vertices in \mathcal{X}_n^k is 3, implying any two vertices in \mathcal{X}_n^k have no common neighbors [49]. In addition, the degree of any vertex in \mathcal{X}_n^k is 3 with each neighbor belonging to three different subsets $\mathcal{X}_n^{k'}$ other than \mathcal{X}_n^k , and any vertex in $\mathcal{V}(\mathcal{H}_n) \setminus \mathcal{X}_n^k$ is linked to exactly one vertex in \mathcal{X}_n^k . Thus, every \mathcal{X}_n^k , $k = 1, 2, 3, 4$, is a minimum dominating set of \mathcal{S}_n^+ .

For the four minimum domination sets $\mathcal{X}_n^1, \mathcal{X}_n^2, \mathcal{X}_n^3, \mathcal{X}_n^4$ in \mathcal{S}_n^+ , considering the vertex subset $\mathcal{V}(\mathcal{H}_n) \subset \mathcal{V}(\mathcal{S}_n^+)$, we have that the types of the three extreme vertices a_n, b_n , and c_n are in succession D-D-I, D-I-D, I-D-D, and C-C-C, respectively. We now prove that $\mathcal{X}_n^1, \mathcal{X}_n^2, \mathcal{X}_n^3$, and \mathcal{X}_n^4 are the only four possible minimum dominating sets of \mathcal{S}_n^+ by induction. For $n = 1$, $\mathcal{X}_1^1 = \{c_1\}$, $\mathcal{X}_1^2 = \{b_1\}$, $\mathcal{X}_1^3 = \{a_1\}$, and $\mathcal{X}_1^4 = \{s\}$, all of which are the possible minimum dominating sets of \mathcal{S}_1^+ and are uniquely determined by the types of the three extreme vertices.

Suppose that $\mathcal{X}_n^1, \mathcal{X}_n^2, \mathcal{X}_n^3$, and \mathcal{X}_n^4 are the only minimum dominating sets of \mathcal{S}_n^+ . That means for any minimum dominating set $\mathcal{X}_n^k, k = 1, 2, 3, 4$, the types of the three extreme vertices of \mathcal{H}_n are determined, it is the same with the types for extreme vertices of \mathcal{H}_{n-2}^i . In other words, the types of the three extreme vertices of \mathcal{H}_n are sufficient to determine all minimum dominating sets in \mathcal{S}_n^+ . For \mathcal{H}_{n+2} , we next prove that $\mathcal{X}_{n+2}^1, \mathcal{X}_{n+2}^2, \mathcal{X}_{n+2}^3$, and \mathcal{X}_{n+2}^4 are the only possible minimum dominating sets of \mathcal{S}_{n+2}^+ .

As shown above, with respect to any minimum dominating set \mathcal{D}_2 of \mathcal{S}_{n+2}^+ , for the three extreme vertices of \mathcal{H}_{n+2} , either all are of type C, or one is of type I, while the other two should be of type D. Given the initial types of the three extreme vertices of \mathcal{H}_{n+2} as those in $\mathcal{X}_{n+2}^1, \mathcal{X}_{n+2}^2, \mathcal{X}_{n+2}^3$, and \mathcal{X}_{n+2}^4 , the types of the extreme vertices of its nine subgraphs $\mathcal{H}_n^i, i = 1, 2, \dots, 9$, are uniquely determined, belonging to D-D-I, D-I-D, I-D-D, or C-C-C, see Fig. 20. By induction hypothesis, given initial types the three extreme vertices a_{n+2}, b_{n+2} , and c_{n+2} , the vertices in \mathcal{H}_n^i that are in a minimum dominating set are uniquely determined. Consequently, $\mathcal{X}_{n+2}^1, \mathcal{X}_{n+2}^2, \mathcal{X}_{n+2}^3$, and \mathcal{X}_{n+2}^4 are the only four minimum dominating sets of \mathcal{S}_{n+2}^+ . Thus the proof is completed. \square

Note that 1-perfect codes [51] and $L(2, 1)$ -labelings [52] have been studied for Sierpiński graphs, which are generalization of the Tower of Hanoi graphs. 1-perfect codes are also called efficient dominating sets. For a graph $\mathcal{G} = (\mathcal{V}, \mathcal{E})$, a subset \mathcal{C} of \mathcal{V} is a 1-perfect code if and only if the neighbours of every vertex v in \mathcal{C} , including v itself, form a partition of \mathcal{V} . In [51], it was shown that there are exactly 3 1-perfect codes in \mathcal{H}_n for odd n ; while in [52], it was proved that there exists an almost perfect code in \mathcal{H}_n . In the first case the special vertex s is not added to a perfect code, while in the second case s is added to an almost perfect code. This yields four minimum dominating sets of \mathcal{S}_n^+ as stated in Theorem 4.10. However, our proof for Theorem 4.10 is short, since we only touch on the Hanoi graphs, while the two previous papers [51, 52] deal with a broad class of Sierpiński graphs, subsuming the Hanoi graphs as particular cases. Thus, to some extent our work and previous ones [51, 52] are complementary to each other, at least

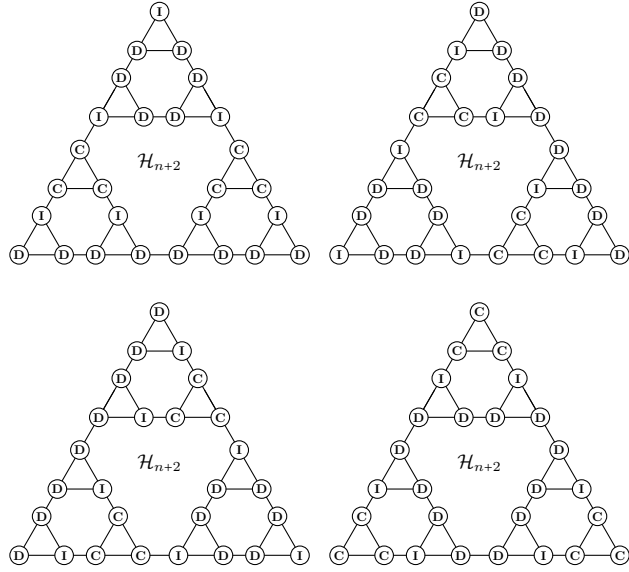

Figure 20: Types of extreme vertices for \mathcal{H}_n^i , $i = 1, 2, \dots, 9$ as nine constituents of \mathcal{H}_{n+2} , given the types of its three extreme vertices a_{n+2} , b_{n+2} , c_{n+2} .

for the Hanoi graphs \mathcal{H}_n with odd n .

Fig. 18 provides the four different minimum dominating sets for \mathcal{S}_3^+ . Although for odd n , there are only four possible minimum dominating sets for \mathcal{S}_n^+ , for even n , the number of minimum dominating sets in \mathcal{S}_n^+ is high. For example, numerical result shows that there are 22 different minimum dominating sets in \mathcal{S}_2^+ . Future work should include explicit determination of the number of minimum dominating sets in \mathcal{S}_n^+ for even n .

Acknowledgements

This work is supported by the National Natural Science Foundation of China under Grant No. 11275049. The authors are grateful to the anonymous reviewers for their valuable comments and suggestions, which have led to improvement of this paper.

References

- [1] L. Lovász, M. D. Plummer, Matching Theory, volume 29 of *Annals of Discrete Mathematics*, North Holland, New York, 1986.

- [2] T. W. Haynes, S. Hedetniemi, P. Slater, *Fundamentals of Domination in Graphs*, Marcel Dekker, New York, 1998.
- [3] E. W. Montroll, Lattice statistics, in: E. Beckenbach (Ed.), *Applied Combinatorial Mathematics*, Wiley, New York, 1964, pp. 96–143.
- [4] D. Vukićević, Applications of perfect matchings in chemistry, in: M. Dehmer (Ed.), *Structural Analysis of Complex Networks*, Birkhäuser Boston, 2011, pp. 463–482.
- [5] J. Wu, Extended dominating-set-based routing in ad hoc wireless networks with unidirectional links, *IEEE Trans. Parallel Distrib. Syst.* 13 (2002) 866–881.
- [6] C. Shen, T. Li, Multi-document summarization via the minimum dominating set, in: *Proceedings of the 23rd International Conference on Computational Linguistics, 2010*, Association for Computational Linguistics, pp. 984–992.
- [7] Y. Y. Liu, A.-L. Barabási, Control principles of complex systems, *Rev. Mod. Phys.* 88 (2016) 035006.
- [8] Y.-Y. Liu, J.-J. Slotine, A.-L. Barabási, Controllability of complex networks, *Nature* 473 (2011) 167–173.
- [9] T. Nepusz, T. Vicsek, Controlling edge dynamics in complex networks, *Nat. Phys.* 8 (2012) 568–573.
- [10] J. C. Nacher, T. Akutsu, Dominating scale-free networks with variable scaling exponent: heterogeneous networks are not difficult to control, *New J. Phys.* 14 (2012) 073005.
- [11] J. C. Nacher, T. Akutsu, Structural controllability of unidirectional bipartite networks, *Sci. Rep.* 3 (2013) 1647.
- [12] I. S. Klickstein, A. Shirin, F. Sorrentino, Energy scaling of targeted optimal control of complex networks, *Nat. Commun.* 8 (2017) 15145.
- [13] E. H. Kuo, Applications of graphical condensation for enumerating matchings and tilings, *Theor. Comput. Sci.* 319 (2004) 29 – 57.
- [14] W. Yan, Y.-N. Yeh, F. Zhang, Graphical condensation of plane graphs: A combinatorial approach, *Theor. Comput. Sci.* 349 (2005) 452 – 461.

- [15] W. Yan, F. Zhang, Graphical condensation for enumerating perfect matchings, *J. Comb. Theory Ser. A* 110 (2005) 113 – 125.
- [16] W. Yan, F. Zhang, A quadratic identity for the number of perfect matchings of plane graphs, *Theor. Comput. Sci.* 409 (2008) 405–410.
- [17] E. Teufl, S. Wagner, Exact and asymptotic enumeration of perfect matchings in self-similar graphs, *Discrete Math.* 309 (2009) 6612 – 6625.
- [18] P. Chebolu, A. Frieze, P. Melsted, Finding a maximum matching in a sparse random graph in $O(n)$ expected time, *J. ACM* 57 (2010) 24.
- [19] R. Yuster, Maximum matching in regular and almost regular graphs, *Algorithmica* 66 (2013) 87–92.
- [20] Z. Zhang, B. Wu, Pfaffian orientations and perfect matchings of scale-free networks, *Theoret. Comput. Sci.* 570 (2015) 55–69.
- [21] N. Meghanathan, Maximal assortative matching and maximal dissortative matching for complex network graphs, *Comput. J.* 59 (2016) 667–684.
- [22] H. Li, Z. Zhang, Maximum matchings in scale-free networks with identical degree distribution, *Theoret. Comput. Sci.* 675 (2017) 64–81.
- [23] F. V. Fomin, F. Grandoni, A. V. Pyatkin, A. A. Stepanov, Combinatorial bounds via measure and conquer: Bounding minimal dominating sets and applications, *ACM Tran. Algorithms* 5 (2008) 9.
- [24] A.-R. Hedar, R. Ismail, Simulated annealing with stochastic local search for minimum dominating set problem, *Int. J. Mach. Learn. Cybernet.* 3 (2012) 97–109.
- [25] G. D. da Fonseca, C. M. de Figueiredo, V. G. P. de Sá, R. C. Machado, Efficient sub-5 approximations for minimum dominating sets in unit disk graphs, *Theoret. Comput. Sci.* 540 (2014) 70–81.
- [26] M. Gast, M. Hauptmann, M. Karpinski, Inapproximability of dominating set on power law graphs, *Theoret. Comput. Sci.* 562 (2015) 436–452.
- [27] J.-F. Couturier, R. Letourneur, M. Liedloff, On the number of minimal dominating sets on some graph classes, *Theoret. Comput. Sci.* 562 (2015) 634–642.

- [28] L. Shan, H. Li, Z. Zhang, Domination number and minimum dominating sets in pseudofractal scale-free web and Sierpiński graph, *Theoret. Comput. Sci.* 677 (2017) 12–30.
- [29] L. Valiant, The complexity of computing the permanent, *Theor. Comput. Sci.* 8 (1979) 189–201.
- [30] L. Valiant, The complexity of enumeration and reliability problems, *SIAM J. Comput.* 8 (1979) 410–421.
- [31] S. Assadi, S. Khanna, Y. Li, On estimating maximum matching size in graph streams, in: *Proceedings of the 28th annual ACM-SIAM symposium on discrete algorithms, 2017*, SIAM, pp. 1723–1742.
- [32] P. A. Golovach, P. Heggernes, D. Kratsch, Enumerating minimal connected dominating sets in graphs of bounded chordality, *Theoret. Comput. Sci.* 630 (2016) 63–75.
- [33] J. S. Andrade Jr, H. J. Herrmann, R. F. Andrade, L. R. Da Silva, Apollonian networks: Simultaneously scale-free, small world, euclidean, space filling, and with matching graphs, *Phys. Rev. Lett.* 94 (2005) 018702.
- [34] S. Klavžar, B. Mohar, Crossing numbers of Sierpiński-like graphs, *J. Graph Theory* 50 (2005) 186–198.
- [35] A. Barabási, R. Albert, Emergence of scaling in random networks, *Science* 286 (1999) 509–512.
- [36] D. Watts, S. Strogatz, Collective dynamics of ‘small-world’ networks, *Nature* 393 (1998) 440–442.
- [37] M. E. J. Newman, The structure and function of complex networks, *SIAM Rev.* 45 (2003) 167–256.
- [38] S.-C. Chang, L.-C. Chen, W.-S. Yang, Spanning trees on the Sierpiński gasket, *J. Stat. Phys.* 126 (2007) 649–667.
- [39] Z. Zhang, L. Chen, S. Zhou, L. Fang, J. Guan, T. Zou, Analytical solution of average path length for Apollonian networks, *Phys. Rev. E* 77 (2008) 017102.
- [40] J. Zhang, W. Sun, G. Xu, Enumeration of spanning trees on Apollonian networks, *J. Stat. Mech.* 2013 (2013) P09015.

- [41] Z. Zhang, B. Wu, F. Comellas, The number of spanning trees in Apollonian networks, *Discrete Appl. Math.* 169 (2014) 206 – 213.
- [42] P. Zhang, H. Mahmoud, The degree profile and weight in Apollonian networks and k -trees, *Adv. Appl. Prob.* 48 (2016) 163–175.
- [43] A. M. Hinz, S. Klavžar, U. Milutinović, C. Petr, *The Tower of Hanoi—Myths and Maths*, Springer, 2013.
- [44] C. Savage, A survey of combinatorial Gray codes, *SIAM Rev.* 39 (1997) 605–629.
- [45] A. M. Hinz, S. Klavžar, S. S. Zemljic, A survey and classification of Sierpiński-type graphs, *Discrete Appl. Math.* 217 (2017) 565–600.
- [46] H. Chen, R. Wu, G. Huang, H. Deng, Dimer–monomer model on the Towers of Hanoi graphs, *Int. J. Mod. Phys. B* 29 (2015) 1550173.
- [47] S.-C. Chang, L.-C. Chen, Dimer coverings on the Sierpiński gasket, *J. Stat. Phys.* 131 (2008) 631–650.
- [48] E. Teufl, S. Wagner, Enumeration problems for classes of self-similar graphs, *J. Comb. Theory Ser. A* 114 (2007) 1254–1277.
- [49] C.-K. Li, I. Nelson, Perfect codes on the Towers of Hanoi graph, *Bull. Austral. Math. Soc.* 57 (1998) 367–376.
- [50] P. Cull, I. Nelson, Error-correcting codes on the Towers of Hanoi graphs, *Discrete Math.* 208 (1999) 157–175.
- [51] S. Klavžar, U. Milutinović, C. Petr, 1-perfect codes in Sierpiński graphs, *Bull. Austral. Math. Soc.* 66 (2002) 369–384.
- [52] S. Gravier, S. Klavžar, M. Mollard, Codes and $L(2,1)$ -labelings in Sierpiński graphs, *Taiwanese J. Math.* (2005) 671–681.