

A Tight Lower Bound for Counting Hamiltonian Cycles via Matrix Rank*

Radu Curticapean[†] Nathan Lindzey[‡] Jesper Nederlof[§]

Abstract

For even $k \in \mathbb{N}$, the matchings connectivity matrix \mathbf{M}_k is a binary matrix indexed by perfect matchings of the complete k -vertex graph; the entry at (M, M') is 1 iff $M \cup M'$ forms a single cycle. Previous work has found connections between the asymptotic rank of \mathbf{M}_k and the complexity of the Hamiltonian Cycle problem: Cygan et al. (STOC 2013) showed that the rank of \mathbf{M}_k over \mathbb{Z}_2 is $\Theta(\sqrt{2}^k)$ and used this to give an $O^*((2 + \sqrt{2})^{\text{pw}})$ time algorithm for counting Hamiltonian cycles modulo 2 on graphs of pathwidth pw . The algorithm carries over to the decision problem via witness isolation. The same authors complemented their algorithm by an essentially tight lower bound under the Strong Exponential Time Hypothesis (SETH). This bound crucially relied on a large permutation submatrix within \mathbf{M}_k , which enabled a “pattern propagation” commonly used in previous related lower bounds, as initiated by Lokshtanov et al. (SODA 2011).

We present a new technique to simulate a similar “pattern propagation” when only a **lb** lower bound on the asymptotic rank of \mathbf{M}_k is given; no stronger structural insights such as the existence of large permutation submatrices in \mathbf{M}_k are needed. Given appropriate rank bounds, our technique yields lower bounds for counting Hamiltonian cycles (also modulo fixed primes p) parameterized by pathwidth.

To apply this technique, we prove that the rank of \mathbf{M}_k over the rationals is $4^k/\text{poly}(k)$, using the representation theory of the symmetric group and various insights from algebraic combinatorics. A bipartite version of \mathbf{M}_k was shown to have essentially rank 2^k by Raz and Spieker (STOC 1993). We also show that the rank of \mathbf{M}_k over \mathbb{Z}_p is $\Omega(1.56^k)$ for any prime $p \neq 2$.

As a consequence, we obtain that Hamiltonian cycles cannot be counted in time $O^*((6 - \varepsilon)^{\text{pw}})$ for any $\varepsilon > 0$ unless SETH fails. This bound is tight due to a $O^*(6^{\text{pw}})$ time algorithm by Bodlaender et al. (ICALP 2013). We also obtain that Hamiltonian cycles cannot be counted modulo primes $p \neq 2$ in time $O^*(3.56^{\text{pw}})$; when compared to the $O^*((2 + \sqrt{2})^{\text{pw}}) = O^*(3.42^{\text{pw}})$ time algorithm for counting mod 2 (and decision) by Cygan et al. (STOC 2013), this indicates that the modulus can affect the complexity of the problem in intricate ways.

*Part of this work was done while Radu and Jesper were visiting the Simons Institute for the Theory of Computing.

[†]Institute for Computer Science and Control, Hungarian Academy of Sciences (MTA SZTAKI). radu.curticapean@gmail.com. Supported by ERC Grant PARAMTIGHT (No. 280152) and ERC Grant SYSTEMATICGRAPH (No. 725978).

[‡]Department of Combinatorics and Optimization, University of Waterloo. nlindzey@uwaterloo.ca.

[§]Department of Mathematics and Computer Science, Technische Universiteit Eindhoven. j.nederlof@tue.nl. Supported by NWO Veni project 639.021.438

1 Introduction

Rank is a fundamental concept in linear algebra and has numerous applications in diverse areas of discrete mathematics and theoretical computer science, such as algebraic complexity [8], communication complexity [26], and extremal combinatorics [29], to name only a few examples. A common phenomenon in these areas is that low rank often helps in proving combinatorial upper bounds or designing algorithms, e.g., through representative sets [7, 13, 20] or the polynomial method (which ultimately relies on fast rectangular matrix multiplication, enabled through low-rank factorizations of problem-related matrices [38]). In particular, rank has recently found applications in *fine-grained* $\#P$ and the closely related area of *treewidth*. In the latter, several influential results, such as algorithms for kernelization [20], the longest path problem [30], and connectivity problems parameterized by treewidth [12, 11, 7], rely crucially on low-rank factorizations.

In view of the utility of low rank in proving upper bounds, it is natural to ask, conversely, whether high rank translates into lower bounds. Indeed, examples for this connection can be found in communication complexity (e.g. [21, Section 1.4]) and circuit complexity (e.g [16]). In the present paper, we find such applications also in fine-grained and parameterized complexity: We develop a technique that allows us to transform rank lower bounds into conditional lower bounds for the problem $\#HC$ of counting Hamiltonian cycles. The decision version HC of this problem, which asks for the existence of a Hamiltonian cycle, is a classical subject of algorithmic research, with a well-known $O^*(2^n)$ time dynamic programming algorithm that stood for decades until the celebrated $O^*(1.657^n)$ time randomized algorithm from [4] appeared. This striking result spawned several novel algorithmic insights into HC , but, above all, showed that we are still far from understanding this problem in a satisfactory way: We still have no $O^*((2 - \varepsilon)^n)$ time algorithm for HC , and even no randomized $O^*((2 - \varepsilon)^n)$ time algorithms are known for the more general traveling salesman problem, the directed Hamiltonian cycle problem, or the counting version $\#HC$.

One of the novel algorithmic techniques for HC is closely tied to the rank of the so-called matchings connectivity matrix [11]. For even k , the matchings connectivity matrix \mathbf{M}_k is indexed by the perfect matchings of the complete graph K_k , and the entry $\mathbf{M}_k[M, M']$ for perfect matchings M and M' is defined as 1 if the union $M \cup M'$ is a single cycle, and 0 otherwise. The authors of [11] show that the rank of \mathbf{M}_k over \mathbb{Z}_2 is precisely $2^{k/2-1}$. This surprisingly low rank gives rise to fast algorithms that allow, e.g., to count Hamiltonian cycles modulo 2 in directed graphs in $O(1.888^n)$ time (which was recently improved to $O^*(3^{n/2})$ time in [6]). A randomized algorithm for the decision version follows from witness isolation.

The low rank of \mathbf{M}_k also enabled an $O^*((2 + \sqrt{2})^{pw})$ time algorithm for HC on graphs with a given path decomposition of width pw . For this problem, the (relatively) standard dynamic programming approach would require to keep track of all partitions of separators, resulting in a running time of $O^*(2^{pw \log pw})$. It is thus somewhat remarkable that the single-exponential running time of $O^*((2 + \sqrt{2})^{pw})$ can be achieved. Even more surprisingly, the base $2 + \sqrt{2}$ appears to be optimal, as there is no $O((2 + \sqrt{2} - \varepsilon)^{pw})$ time algorithm unless the Strong Exponential Time Hypothesis (SETH) fails [11]. This tight lower bound was proven by combining a general reduction technique for SETH-based lower bounds from [23] with a special property of \mathbf{M}_k , namely, that \mathbf{M}_k contains a principal minor of size $2^{k/2-1}$ that is a permutation matrix. In other words, there is a collection of $2^{k/2-1}$ perfect matchings such that every perfect matching in this collection can be extended to a Hamiltonian cycle by precisely one other member.

¹ See e.g. the nice discussion in [1], and the references therein.

The general reduction technique from [23] has recently gained popularity and resulted in tight lower bounds for many problems parameterized by pathwidth; we survey this technique from a high-level perspective in Section 1. As a consequence of these lower bounds, many problems are now well-understood in the low-pathwidth setting, as their optimal bases in the exponential dependence on the pathwidth have been found under SETH. However, there are natural open cases left, such as #HC: It has been shown that this problem can be solved in $O^*(6^{\text{pw}})$ time [7], later generalized to $O^*(6^{\text{tw}})$ time when parameterized by treewidth [39], but no tight lower bound was known. The lack of progress in lower bounds for this problem might justify optimism towards improved algorithms. For example, if we could lift the $O^*((2 + \sqrt{2})^{\text{pw}})$ time algorithm for #HC modulo 2 to an $O^*((4 - \varepsilon)^{\text{pw}})$ time algorithm for #HC, we could solve #HC on bipartite graphs in $O^*((2 - \varepsilon')^{\text{pw}})$ time, since bipartite graphs have pathwidth at most $n/2$.

Our main results

In the present paper, we strike out the route towards faster algorithms for #HC sketched above: We show that the current pathwidth and treewidth based algorithms are optimal assuming SETH.

Theorem 1.1. *Let $\varepsilon > 0$ and let pw be a pathwidth. Then #HC can be solved in $O^*((6 - \varepsilon)^{\text{pw}})$ time.*

We should note that for all previously NP-hard problems that were previously considered from a fine-grained perspective, the counting and decision versions have the same optimal exponential base; our result gives a natural example for a problem where decision (with base $2 + \sqrt{2}$) and counting (with base 6) differ provably under SETH. When trying to adapt the reduction technique from [23], one quickly observes that new ideas are required to obtain a tight lower bound. One of our contributions towards this lies in extending the reduction technique in a way that it can exploit arbitrary lower bounds on the matrix rank of \mathbf{M}_k , without further insights into the particular structure of basis vectors. That is, we derive Theorem 1.1 as a consequence of the following more general “black-box” connection between the rank of \mathbf{M}_k and the base of the running time for #HC:

Theorem 1.2. *Let $r = \lim_{\beta \rightarrow \infty} \log_2(\text{rank}(\mathbf{M}_\beta)) / \beta$. Then #HC can be solved in $O^*((2 + r - \varepsilon)^{\text{pw}})$ time. Here $\varepsilon > 0$, p is a prime, $r > r_p$, and \mathbf{M}_k is a matrix over \mathbb{Z}_p .*

Towards proving Theorem 1.1, we then combine (a mild generalization of) Theorem 1.2 with our second main contribution: We determine the rank of \mathbf{M}_k over \mathbb{Q} up to polynomial factors, and for primes $p \neq 2$, we additionally give a lower bound on the rank of \mathbf{M}_k over \mathbb{Z}_p that is higher than the rank over \mathbb{Z}_2 .

Theorem 1.3. *Let \mathbf{M}_k be a matrix over \mathbb{Z}_p . Then $\text{rank}(\mathbf{M}_k) \geq \Omega(4^k/k^3)$ for $p \neq 2$, and $\text{rank}(\mathbf{M}_k) \geq \Omega(1.568^k)$ for $p = 2$.*

The bound over \mathbb{Q} is obtained by a novel application of representation theory, inspired by a previous approach from [32], where the rank of a bipartite version of \mathbf{M}_k over \mathbb{Q} was calculated and found to be $\Theta(2^k)$ up to polynomial factors. In the bipartite version of \mathbf{M}_k , only perfect matchings contained in the complete bipartite graph $K_{k/2, k/2}$ are considered. Our non-bipartite version (where any perfect matching in the complete graph K_k is allowed) is the right version for

algorithmic applications, and our new bound over \mathbb{Q} shows that going to the non-bipartite setting increases the rank significantly. Combined with Theorem 1.2, our bound over \mathbb{Z}_p for prime $p \neq 2$ shows that $\#\text{HC}$ modulo 3 is harder than modulo 2: We can solve $\#\text{HC}$ modulo 2 in $O^*((2+\sqrt{2})^{\text{pw}})$ time, with $2 + \sqrt{2} \leq 3.42$, but we cannot solve $\#\text{HC}$ modulo 3 in $O^*(3.568^{\text{pw}})$ time unless SETH fails. This connects to recent striking results [5, 6], which show that the non-parameterized problem $\#\text{HC}$ modulo c^n can be solved in time $O^*((2 - \varepsilon_c)^n)$ where $\varepsilon_c > 0$ depends on the constant c .

Connection matrices and fingerprints

The matchings connectivity matrix \mathbf{M}_k fits into a bigger picture of so-called ~~the~~ graph parameters (functions from graphs into numbers that are invariant under graph isomorphisms), and our bounds on the rank of \mathbf{M}_k easily translate into rank bounds in this framework. The connection matrices of a graph parameter f are a sequence of matrices \mathbf{C}_k , for $k \in \mathbb{N}$, which describe the behavior of f under graph separators of size k . To define these matrices, let us say that a ~~k -graph~~, for $k \in \mathbb{N}$, is a simple graph with k distinguished vertices that are labeled $1, \dots, k$. Two k -boundaried graphs G and H can be glued together, yielding a graph $G \oplus H$, by taking the disjoint union of G and H and identifying vertices with the same label. The k -th connection matrix \mathbf{C}_k of f then is an infinite matrix whose rows and columns are indexed by k -boundaried graphs, such that the entry $\mathbf{C}_k[G, H]$ is $f(G \oplus H)$.

It has been shown that the ranks of connection matrices are intimately related to graph-theoretic, algorithmic, and model-theoretic properties of graph parameters [19, 25, 24]. In particular, the connection matrices \mathbf{C}_k for the number of Hamiltonian cycles were studied in [24, 25], where their rank was upper-bounded by $2^{O(k \log k)}$. As a rather simple consequence of Theorem 1.3, we can improve upon this and obtain the following essentially tight bounds.

Theorem 1.4. ~~For~~ $k \in \mathbb{N}$, ~~the~~ \mathbf{C}_k ~~has~~ rank 6^k , ~~up to~~

To prove this theorem, we use a third matrix, the fingerprint matrix \mathbf{H}_k for Hamiltonian cycles, which will also play an important role later.² A ~~finger~~ fingerprint of a k -boundaried graph is a pair (d, M) , where $d \in \{0, 1, 2\}^k$ assigns 0, 1 or 2 to each boundary vertex, and M is a perfect matching on the boundary vertices to which d assigns 1. Fingerprints are essentially the states one would use in the natural dynamic programming routine for counting Hamiltonian cycles parameterized by pathwidth; they describe the behavior of a Hamiltonian cycle on a given side of a separation. A pair of fingerprints (d, M) and (d', M') on B ~~is~~ if $d_v + d'_v = 2$ for every $v \in B$ and additionally $M \cup M'$ forms a single cycle. The fingerprint matrix \mathbf{H}_k is a binary matrix, indexed by fingerprints, and the value at a pair of fingerprints is 1 iff the two fingerprints combine.

It can be derived easily from our rank bound for the matchings connectivity matrix \mathbf{M}_k that the rank of \mathbf{H}_k is 6^k up to polynomial factors, see Fact 2.2, and we also observe in Fact 2.3 that \mathbf{C}_k and \mathbf{H}_k have the same rank. This establishes Theorem 1.4.

² To avoid (or add) confusion, let us stress that we consider three matrices related to the Hamiltonian cycle problem: The matchings connectivity matrix \mathbf{M}_k , the connection matrix \mathbf{C}_k for the number of Hamiltonian cycles, and the fingerprint matrix \mathbf{H}_k for Hamiltonian cycles. We will revisit their differences in Section 2. While these matrices are closely related, our arguments benefit from using different matrices for different proofs.

Proof techniques

In the remainder of the introduction, we sketch the techniques used to obtain our main results, i.e., the bounds on the rank of \mathbf{M}_k (Theorem 1.3), and the complexity lower bound for $\#\text{HC}$ under SETH (Theorem 1.2) assuming high rank of \mathbf{M}_k . These two results together imply Theorem 1.1.

Bounding the rank of the matchings connectivity matrix

To prove Theorem 1.3, we give two different lower bounds for the rank of \mathbf{M}_k : One is a relatively simple lower bound of $\Omega(1.568^k)$, which we include in Appendix C. Towards this bound, we first explicitly compute the rank of \mathbf{M}_{10} with a computer program, and then we exploit a product construction to give lower bounds for \mathbf{M}_{10t} . While the resulting bound is loose, it also applies to the rank of \mathbf{M}_k over \mathbb{Z}_p for prime $p \neq 2$, whereas our more sophisticated main bound does not. We obtain, e.g., that the rank of \mathbf{M}_k over \mathbb{Z}_3 is larger than over \mathbb{Z}_2 .

Our main result however is that the rank of \mathbf{M}_k is 4^k over \mathbb{Q} , up to polynomial factors. This builds upon representation-theoretic techniques that were also used in Raz and Spieker’s bound [32] for the bipartite version of \mathbf{M}_k . Let us say that a **hook partition** λ of some number $k \in \mathbb{N}$ is a number partition with the particular form $(t, 1, \dots, 1)$ for some $t \leq k$. One can view λ as a **hook diagram**, which is a Γ -shaped diagram made of cells, as shown in Figure 2a on page 9. A **hook labeling** of shape λ then is a labeling of this diagram with numbers from $[k]$ such that the numbers are strictly increasing in each row and each column. Raz and Spieker showed that the rank of the bipartite variant of \mathbf{M}_{2k} can be expressed as a weighted sum over all hook partitions λ of k , where each λ is weighted by the squared number of Young tableaux of shape λ . This somewhat intimidating sum simplifies to the central binomial coefficient $\binom{2k-2}{k-1}$, which implies a bound of $\Theta(2^k)$ for the rank of the bipartite variant of \mathbf{M}_k , up to polynomial factors.

To address the non-bipartite setting, we found ourselves in need of additional techniques from algebraic combinatorics that were not present in Raz and Spieker’s original bound, such as the perfect matching association scheme [14] and zonal spherical functions [28]. With these at hand, we prove that the rank of \mathbf{M}_{2k} can be lower-bounded by a similar sum over number partitions λ as in the bipartite case, this time however ranging over **double hook partitions** λ , which have the form $(2t, 2t, 2, \dots, 2)$ for some $t \leq k$. As in the bipartite case, we then observe that this sum simplifies significantly, this time however to (essentially) a product of two consecutive Catalan numbers. From this, we obtain a lower bound of 4^k for the rank of \mathbf{M}_k , up to polynomial factors. It then easily follows from the upper bound in the bipartite setting that this bound is tight, up to polynomial factors.

SETH-hardness via assignment propagation

To describe how we turn lower bounds on the rank of \mathbf{M}_k into algorithmic intractability results for $\#\text{HC}$ under SETH, let us first survey the SETH-based lower bounds for problems parameterized by pathwidth from [23]. We dub their main construction a **SETH reduction**: Given a CNF-formula φ with n variables, such a scheme produces an equivalent instance I of the target problem with parameter value $k \leq cn$ for some constant $c \leq 1$. An algorithm with running time $O^*((2^{1/c} - \varepsilon)^k)$ for the target problem would then refute SETH, as it would imply a $O^*((2 - \varepsilon)^n)$ time algorithm for CNF-SAT.

The constructed target instances I have the outline sketched in Figure 1: The n variables of φ

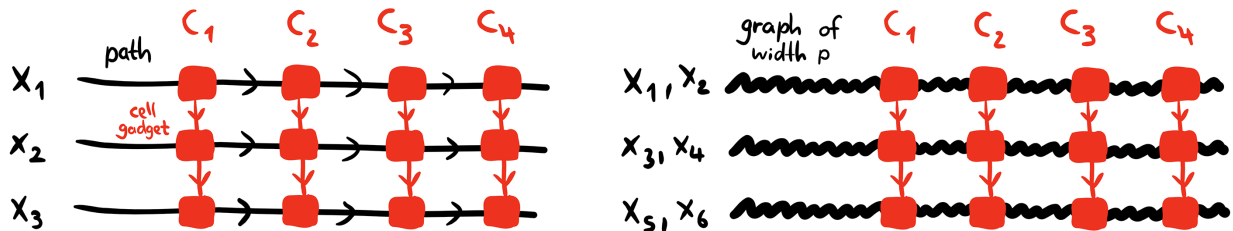

Fig. 1: The left figure shows a block propagation scheme for $n = 3$ variables and $m = 4$ clauses, with block size $\beta = 1$ and row width 1. Variable assignments are propagated from left to right, clause satisfaction is propagated from top to bottom. The right figure shows a block propagation scheme for $n = 6$ variables, block size $\beta = 2$, and row width p .

are grouped into $t = \lceil n/\beta \rceil$ blocks of constant size β , where β depends only on the ϵ in the running time we wish to rule out. The variable blocks are represented as rows, each of which propagates an assignment of type $\{0, 1\}^\beta$, using a thin graph of width $p \in \mathbb{N}$, where p depends on β (which in turn depends on ϵ) and the combinatorial freedom given in the target problem. Assignments are represented as partial solutions to the target problem, e.g., as partial colorings or, in our case, as fingerprints of Hamiltonian cycles. Intuitively, if we are able to choose p small for large β , then this means that the target problem allows us to “pack” assignments to large blocks into “thin wires”.

In a block propagation scheme, the clauses of φ are furthermore represented as columns; each column checks whether the overall assignment of type $\{0, 1\}^n$ propagated by the rows satisfies its corresponding clause. To this end, one can use cell gadgets, which are graphs with p left and p right interface vertices, and c top/bottom interface vertices, where c is a fixed constant (depending only on the target problem). The cell gadget is placed at the intersection of a row and a column, and it needs to “decode” an assignment $x \in \{0, 1\}^\beta$ from the state of the left p interface vertices, decide whether x satisfies the clause, and “encode” x back into the state of right p vertices. The top and bottom interface is used to propagate, from the top of a column downwards, whether the respective clause is already satisfied by the partial assignments to the blocks above a given cell. From the grid structure used in the construction, the overall pathwidth of the instance I can be bounded by $tp + O(1)$, where the additive constant accounts for the size of cell gadgets.

In block propagation schemes, the main technical effort lies in constructing cell gadgets: This usually requires engineering a gadget that is at least as powerful as a “state tester”, a gadget that can test whether the p left or right vertices connected to the row are in a particular state S , say, a particular coloring, or a particular fingerprint of a Hamiltonian cycle, as the cell gadget needs to extract the partial assignment to the associated variable block to check whether it satisfies the clause at hand. To realize such state testers, one constructs a graph that can be extended to a solution of the target instance (e.g., a coloring, or a Hamiltonian cycle) iff the relevant vertices are in state S , and for various problems, such constructions can be achieved with some effort.

In our construction of cell gadgets for counting Hamiltonian cycles, we face the dire situation that testers for fingerprints of Hamiltonian cycles ~~dit~~ : There are fingerprints S such that any graph that allows extending S to a Hamiltonian cycle also extends some unwanted fingerprints $S' \neq S$. Our main insight here is that this problem can be solved by firstly restricting to a set of 6^β good fingerprints that induce a full-rank submatrix \mathbf{F} of \mathbf{H}_β , and secondly simulating a “linear combination” of testers, with coefficients obtained from the inverse of \mathbf{F} . In the fingerprint tester

for S , other fingerprints $S' \neq S$ have extensions of non-zero weight, but the weights of these extensions are chosen in such a way (depending on \mathbf{F}^{-1}) that extensions of $S' \neq S$ cancel out. This ultimately allows us to simulate a state tester for fingerprints, and the necessity for canceling extensions also shows why this lower bound is inherently within the realm of counting complexity and cannot work for the decision version of the Hamiltonian cycle problem. (This is fortunate, since an $O^*((2 + \sqrt{2})^{\text{pw}})$ time algorithm is known for the decision version.) We believe that similar “state testers” from matrix inversion can be obtained for other counting problems, but it currently seems that their construction is inherently problem-specific.

It should be noted that the above high-level description is a somewhat simplified account of our construction. For instance, to ensure assignment propagation, one needs more general gadgets than mere state testers for fingerprints. Fortunately, to construct these gadgets, we can re-purpose parts of the machinery developed for ruling out $O^*((2 + \sqrt{2} - \varepsilon)^{\text{pw}})$ time for the decision version. In this setting, tester gadgets rely crucially on the fact that \mathbf{M}_β contains a permutation sub-matrix of order $2^{\beta/2-1}$, and testing for one of these $2^{\beta/2-1}$ good fingerprints exploits the consequence that any such fingerprint can be extended by precisely one good fingerprint.

Giving a more precise overview over our reduction requires some preliminaries, which we will have acquired by the beginning of Section 4, where we give another 1-page overview over the reduction and our particular use of \mathbf{M}_β .

2 Preliminaries and notation

If φ is a CNF-formula, and x is a (partial) assignment to its variables, we write $x \models \varphi$ to denote that x satisfies φ . For integers n , we let $[n] = \{1, \dots, n\}$. All graphs in this paper will be undirected. If $G = (V, E)$ is a graph, $v \in V$ is a vertex and $H \subseteq E$ is an edge set, we let $d_H(v)$ denote the number of edges in H that are incident to v . We write \mathcal{M}_{2n} for the set of all perfect matchings of the complete graph K_{2n} .

Strong Exponential Time Hypothesis (SETH) As posed by Impagliazzo and Paturi [18], the complexity assumption SETH states that for every $\varepsilon > 0$, there is a constant k such that k -CNF-SAT (the satisfiability problem for k -CNF formulas on n variables) cannot be solved in time $O^*((2 - \varepsilon)^n)$. It is quite common to allow randomization in this hypothesis, making the hypothesis slightly stronger. A result from Calabro et al. [9, Theorem 1] gives a randomized reduction from k -CNF-SAT to the problem UNIQUE- k -CNF-SAT, where the k -CNF formula is guaranteed to have at most one satisfying assignment. This allows, without loss of generality, to assume that the k -CNF formulas in the statement of (randomized) SETH have at most one satisfying assignment.

Pathwidth and path decompositions A \mathfrak{h} of a graph $G = (V, E)$ is a path \mathbb{P} in which each node x has an associated set of vertices $B_x \subseteq V$ (called a \mathfrak{b}_x) such that $\bigcup_x B_x = V$ and the following properties hold:

1. For each edge $\{u, v\} \in E$ there is a node x in \mathbb{P} such that $u, v \in B_x$.
2. If $v \in B_x \cap B_y$ then $v \in B_z$ for all nodes z on the (unique) path from x to y in \mathbb{P} .

The \mathfrak{w} of \mathbb{P} is the size of the largest bag minus one, and the pathwidth of a graph G is the minimum width over all possible path decompositions of G . A path decomposition \mathfrak{h} has width L if

the first bag contains L and R if the last bag contains R . Since our focus here is on path decompositions, we only mention in passing that the related notion of treewidth can be defined in the same way, except for letting the nodes of the decomposition form a tree instead of a path.

Kronecker products of matrices Given a field \mathbb{F} and matrices $\mathbf{A} \in \mathbb{F}^{n \times m}$ and $\mathbf{B} \in \mathbb{F}^{n' \times m'}$, their Kronecker product $\mathbf{A} \otimes \mathbf{B}$ is a matrix in $\mathbb{F}^{n \cdot n' \times m \cdot m'}$. Its rows can be indexed by pairs $(i, i') \in [n] \times [n']$ and its columns can be indexed by $(j, j') \in [m] \times [m']$. The entry of $\mathbf{A} \otimes \mathbf{B}$ at row (i, i') and column (j, j') is defined as $\mathbf{A}[i, j] \cdot \mathbf{B}[i', j']$. For $t \in \mathbb{N}$, the t -th Kronecker power of \mathbf{A} is defined as the t -fold product $\mathbf{A}^{\otimes t} = \mathbf{A} \otimes \dots \otimes \mathbf{A}$. We consider its rows and columns to be indexed by $[n]^t$ and $[m]^t$ respectively.

If \mathbf{A} and \mathbf{B} each have full rank over \mathbb{F} , then it is an elementary fact that $\mathbf{A} \otimes \mathbf{B}$ also has full rank over \mathbb{F} . Note that this property requires \mathbb{F} to be a field; it would fail if \mathbb{F} contained zero divisors. For our purposes of computing the rank of matrices over \mathbb{Z}_p , this means we can invoke this property only when p is a prime.

Fingerprints The fingerprints (which we often abbreviate as *fp*) capture the states of the natural dynamic program for Hamiltonian cycles:

Definition 2.1 (Fingerprint, Partial Solutions). Let $G = (V, E)$ be a graph and $B \subseteq V$ (B is a k -subset). A fingerprint on B is a pair (d, M) where $d \in \{0, 1, 2\}^B$ and $M \subseteq E$ is a matching. A partial solution in G for (d, M) is a matching $H \subseteq E$ such that $d_H(v) = 2$ for $v \in V \setminus B$, $d_H(v) = d_v$ for $v \in B$, and $(u, v) \in M \implies (u, v) \in H$.

Two partial solutions (d, M) and (d', M') *combine* (or *match*) if $d_v + d'_v = 2$ for $v \in B$ and $M \cup M'$ is a matching.

Variants of connection matrices for the Hamiltonian cycle problem Our paper studies three related matrices that describe the behavior of Hamiltonian cycles under separators. We recall the definitions of these matrices here for reference:

\mathbf{M}_k (the k -th matchings connectivity matrix): This binary matrix is indexed by perfect matchings $M, M' \in \mathcal{M}_k$. An entry $\mathbf{M}_k[M, M']$ is 1 iff $M \cup M'$ is a single cycle. The matchings connectivity matrix \mathbf{M}_k appears naturally in our rank lower bounds.

\mathbf{H}_k (the k -th fingerprint matrix for Hamiltonian cycles): This binary matrix is indexed by all fingerprints (d, M) on a fixed set B of size k . An entry $\mathbf{H}_k[f, f']$ equals 1 iff f and f' combine. This matrix will be crucially used in the algorithmic lower bound.

\mathbf{C}_k (the k -th connection matrix for Hamiltonian cycles): This integer-valued matrix is indexed by all k -boundaried graphs, and hence infinite. The entry $\mathbf{C}_k[G, G']$ counts the Hamiltonian cycles in the graph $G \oplus G'$. (If an edge between boundary vertices is present in both G and G' , we count it twice in $G \oplus G'$.) While this matrix will not be used in later sections, we introduced it to the established literature on connection matrices.

The subscript k is omitted when clear from the context. As we show below, we can easily transform rank bounds for \mathbf{M}_k into bounds for \mathbf{H}_k and \mathbf{C}_k , thus justifying our focus on the rank of \mathbf{M}_k : Here, we write $\text{npoly}(k)$ to denote the set of polynomials in k with possibly negative (but constant) exponents.

Fact 2.2. f $p \in \text{npoly}(k)$ d $\text{rank}(\mathbf{M}_k) = c^k p(k)$, $\text{rank}(\mathbf{H}_k) = (2+c)^k q(k)$ w $q \in \text{npoly}(k)$.

$\#$ Note that \mathbf{H}_k is a block-diagonal matrix that has a block for every vector $d \in \{0, 1, 2\}^k$, since fingerprints d, d' not satisfying $d(v) + d'(v) = 2$ for all v cannot match. Therefore, we obtain:

$$\text{rank}(\mathbf{H}_k) \geq \sum_{|d^{-1}(1)|=i \text{ even}} \binom{k}{i} 2^{k-i} \text{rank}(\mathbf{H}_i) \geq \frac{1}{k} \sum_{i=1}^k \binom{k}{i} 2^{k-i} p(i) c^i \geq \frac{1}{k} (2+c)^k q(k), \quad (1)$$

where q is a polynomial satisfying $p(i) \geq q(i)$ for $i = 1, \dots, k$, and the last inequality follows from the binomial theorem. The upper bound follows similarly. \square

A simple argument shows that the fingerprint matrix \mathbf{H}_k and the connection matrix \mathbf{C}_k actually have the same rank.

Fact 2.3. $\forall k \in \mathbb{N}$, $\mathbf{H}_k \mathbf{d} \mathbf{C}_k$

$\#$ We first show that $\text{rank}(\mathbf{C}_k) \geq \text{rank}(\mathbf{H}_k)$ by finding \mathbf{H}_k as a submatrix of \mathbf{C}_k . To this end, we construct a k -boundaried graph G_F for every k -fingerprint F and then find \mathbf{H}_k as the submatrix induced by these graphs.

For a given k -fingerprint F , the graph G_F is constructed as follows: At first, it contains only the boundary vertices $1, \dots, k$. Then we add an arbitrary partial solution for F to G_F . For instance, if $F = (d, M)$ and M is non-empty, pick the lexicographically first edge of the matching M , say $ij \in M$, and connect i to j in G_F with a path that passes through all vertices in $d^{-1}(2)$ in an arbitrary order. Then add all edges in $M \setminus \{ij\}$ to G_F as edges. If M is empty, add a Hamiltonian cycle on $d^{-1}(2)$. Finally, subdivide all edges of the graph; this adds some number of subdivision vertices to G_F , which we consider not to be part of the boundary. Note that the degree of boundary vertex $i \in [k]$ in G_F is precisely $d(i)$.

Given two k -fingerprints F, F' , we observe that any Hamiltonian cycle in $G_F \oplus G_{F'}$ uses all edges of the graph, as every edge is incident to a (subdivision) vertex of degree 2. This implies, firstly, that the number of Hamiltonian cycles in $G_F \oplus G_{F'}$ is either 0 or 1. Secondly, it implies that $d_F + d_{F'}$ needs to be the constant 2-function for $G_F \oplus G_{F'}$ to have a Hamiltonian cycle. If this condition is fulfilled, then by construction, $G_F \oplus G_{F'}$ has a Hamiltonian cycle iff $M \cup M'$ forms a single cycle. Summarizing, we have that $\mathbf{C}_k[G_F, G_{F'}] \in \{0, 1\}$ and that $\mathbf{C}_k[G_F, G_{F'}] > 0$ iff F and F' match. This shows that the set of k -boundaried graphs G_F , for k -fingerprints F , induce the fingerprint matrix \mathbf{H}_k as a submatrix in \mathbf{C}_k , and the lower bound on the rank of \mathbf{C}_k follows.

For the upper bound of $\text{rank}(\mathbf{C}_k) \leq \text{rank}(\mathbf{H}_k)$, we find a matrix \mathbf{A}_k such that $\mathbf{C}_k = \mathbf{A}_k \cdot \mathbf{H}_k \cdot \mathbf{A}_k^T$. The rows of \mathbf{A}_k are indexed by k -boundaried graphs G , the columns are indexed by fingerprints F , and we define $\mathbf{A}_k[G, F]$ to count the partial solutions in G for the fingerprint F .

Given two k -boundaried graphs G and G' , every Hamiltonian cycle C in $G \oplus G'$ induces a partial solution in each of G and G' , for fingerprints F and F' , respectively. The pair of fingerprints $P_C = (F, F')$ can be determined uniquely from the partial solutions of C , and since C is a Hamiltonian cycle, it follows that F and F' match. Given a matching pair of fingerprints (F, F') , the number of Hamiltonian cycles of $G \oplus G'$ with $P_C = (F, F')$ is precisely $\mathbf{A}_k[G, F] \cdot \mathbf{A}_k[G', F']$, as the extensions in each of G and G' can be chosen independently, provided they agree with F and F' respectively. We conclude that the number of Hamiltonian cycles in $G \oplus G'$ can be expressed as

$$\sum_{\substack{F, F' \\ \text{match}}} \mathbf{A}_k[G, F] \cdot \mathbf{A}_k[G', F'] = (\mathbf{A}_k \cdot \mathbf{H}_k \cdot \mathbf{A}_k^T)[G, G'].$$

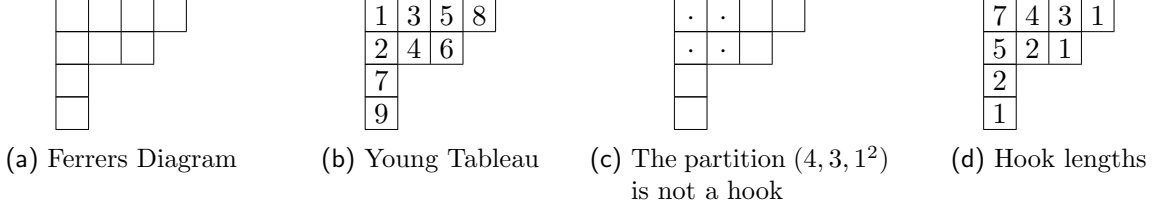

Fig. 2: Illustrations of basic notions from the representation theory of the symmetric group

It follows that $\mathbf{C}_k = \mathbf{A}_k \cdot \mathbf{H}_k \cdot \mathbf{A}_k^T$ as claimed, establishing the upper bound on the rank. \square

3 The rank of matchings connectivity matrix over the rational numbers

In this section we establish the first part of Theorem 1.3. For this we need some basics on the representation theory of the symmetric group which we first briefly outline.

The Representation Theory of the Symmetric Group The representation theory of the symmetric group S_n is remarkable, as much of it may be explained via the combinatorics of \mathfrak{S}_n and \mathfrak{h} . We outline the relevant combinatorial aspects of the theory, leaving the algebraic basics of finite group representation theory for Appendix B. The reader is referred to [34] for a gentle but more thorough introduction.

Let $\lambda = (\lambda_1, \lambda_2, \dots, \lambda_k) \vdash n$ such that $\lambda_1 \geq \lambda_2 \geq \dots \geq \lambda_k$ and $\sum_{i=1}^k \lambda_i = n$ denote an \mathfrak{p} of n . If j parts of the integer partition have the same size m , then we use the shorthand m^j to express these parts. Let $\lambda(n)$ denote the number of integer partitions of n . It is well-known that there is a one-to-one correspondence between the irreducible representations of S_n and the integer partitions of n . We let $[\lambda]$ denote the irreducible representation of S_n that corresponds to $\lambda \vdash n$.

For an integer partition $\lambda \vdash n$, the \mathfrak{y}^λ of λ is an associated left-justified tableau that has λ_i cells in the i th row. Abusing notation, we let λ also refer the Ferrers diagram of $\lambda \vdash n$. In Figure 2a the Ferrers diagram for $(4, 3, 1^2) \vdash 9$ is illustrated.

We obtain a \mathfrak{y}^λ from a Ferrers diagram by labeling its cells with numbers such that the numbers along each row are strictly increasing, and the numbers along each column are strictly increasing. In Figure 2b a standard Young tableau of shape $(4, 3, 1^2)$ is shown.

Let f^λ denote the number of standard Young tableaux of shape $\lambda \vdash n$. There is an elegant combinatorial formula for expressing f^λ .

We say that a tableau $\lambda \mathfrak{s} \mu$ if the cells of μ are contained in the cells of λ . A \mathfrak{b} is a tableau of shape $(k, 1^\ell)$, equivalently, a tableau that does not cover the shape (2^2) . The partition $(4, 3, 1^2)$ is not a hook, as it covers (2^2) , illustrated in Figure 2c.

For each cell $c \in \lambda$ of a Ferrers diagram, say at row i and column j , if we take c along with all cells in row i to the right of c , and all cells in column j that lie below c , we obtain a hook $(k, 1^\ell)$ for some $k, \ell \in \mathbb{N}$. Let $h(c) := k + \ell$ denote the number of cells in this hook, the so-called \mathfrak{h} . In Figure 2d, we have annotated each cell with its corresponding hook length. The following result connects hook lengths with enumerating standard Young tableaux.

Theorem 3.1 (Hook Theorem [34]). $f^\lambda = \frac{n!}{\prod_{c \in \lambda} h(c)}$.

For instance, it is easy to see using the hook formula that $f^\lambda = \binom{k-1}{\ell}$ for any hook $\lambda = (k, 1^\ell)$. A classic result in the representation theory of the symmetric group S_n is that f^λ equals the dimension of the irreducible $[[\lambda]]$ corresponding to λ .

Proposition 3.2 (Dimensions of Irreducibles of S_n [34]). $f^\lambda = \dim[[\lambda]]$.

Relating rank to the number of Young tableaux. We proceed by studying $\mathbf{M} := \mathbf{M}_k$ where we let $k = 2n$. Let A, B be a partition of the vertices of K_{2n} into two parts of size n . Consider the submatrix \mathbf{M}' of \mathbf{M} induced by the perfect matchings of K_{2n} that are also bipartite perfect matchings with respect to the bipartition A, B . In [32], Raz and Spieker show that the eigenspaces of \mathbf{M}' are in fact irreducible representations of S_n , and that the eigenspaces corresponding to nonzero eigenvalues of \mathbf{M}' correspond to the hooks of length n . This result paired with some elementary combinatorics implies the following theorem.

Theorem 3.3 (Raz & Spieker [32]).

$$\text{rank } \mathbf{M}' = \sum_{\substack{\lambda \vdash n \\ \lambda \text{ does not cover } (2^2)}} (f^\lambda)^2 = \binom{2n-2}{n-1}.$$

Since there are $\frac{1}{2} \binom{2n}{2}$ ways to partition $V(K_{2n})$ into two parts A, B of size n , this already gives an upper bound of $\frac{1}{2} \binom{2n-2}{n-1} \binom{2n}{n}$ on the rank \mathbf{M} . We will show this is almost tight.³ One of our key technical theorems is the following exact formula for the rank of \mathbf{M} .

Theorem 3.4. $\lambda \vdash n, 2\lambda = (2\lambda_1, 2\lambda_2, \dots, 2\lambda_k) \vdash 2n$.

$$\text{rank } \mathbf{M} = \sum_{\substack{\lambda \vdash n \\ \lambda \text{ does not cover } (2^3)}} f^{2\lambda}.$$

This result can be seen as the non-bipartite analogue of Theorem 3.3. To prove it, we determine the nonzero eigenvalues of \mathbf{M} ; however, this will require a fair amount of algebraic combinatorics, which we now develop.

Let H_n denote the H_n of order n , equivalently, the group of permutations $\sigma \in S_{2n}$ such that

$$\{\{\sigma(1), \sigma(2)\}, \{\sigma(3), \sigma(4)\}, \dots, \{\sigma(2n-1), \sigma(2n)\}\} = \{\{1, 2\}, \{3, 4\}, \dots, \{2n-1, 2n\}\}.$$

It is a well-known fact that the collection of perfect matchings of K_{2n} can be written as $\mathcal{M}_{2n} := S_{2n}/H_n$. Even though S_{2n}/H_n is not a group, these cosets possess a remarkable amount of algebraic structure.

Let $\mathbb{R}[\mathcal{M}_{2n}]$ be the vector space of real-valued functions over perfect matchings, equivalently, the space of real-valued functions over S_{2n} that are H_n -invariant, that is, $f(\sigma) = f(\sigma h) \forall \sigma \in S_{2n}, h \in H_n$. In [37], Thrall showed this vector space admits the following decomposition into irreducible representations of S_{2n} .

Theorem 3.5 (Thrall '42). $\mathbb{R}[\mathcal{M}_{2n}] = \bigoplus_{\lambda \vdash n} [[2\lambda]]$.

³ Moreover, it can be verified experimentally that for some constant n the rank of \mathbf{M} is strictly smaller than this bound, but lower order terms will not be relevant for us.

A consequence of Thrall's result is that \mathcal{M}_{2n} admits a ~~decomposition~~ $\mathcal{M}_{2n} = \bigoplus_{\lambda \vdash n} \mathcal{M}_{2n}(\lambda)$, the so-called ~~decomposition~~ [14].

Definition 3.6 (Symmetric Association Scheme). ~~Let~~ $m \times m$ ~~matrices~~ A_0, A_1, \dots, A_d ~~satisfy~~

- 1 $A_0 = I$ ~~and~~ I ~~is the~~
- 2 $\sum_{i=0}^d A_i = J$ ~~and~~ J ~~is the~~
- 3 $A_i = A_i^T$ ~~for~~ $i \in \{1, 2, \dots, d\}$.
- 4 $A_i A_j = A_j A_i$ ~~for~~ A_0, A_1, \dots, A_d ~~for~~ $0 \leq i, j \leq d$.
- 5 $A_i A_j = A_j A_i$ ~~for~~ $0 \leq i, j \leq d$.

We refer the reader to [3, 14] for a more thorough treatment of association schemes.

Recall that the union of any two perfect matchings is a disjoint union of cycles, which can be represented by an integer partition of the form $2\lambda \vdash 2n$ where $2\lambda = (2\lambda_1, 2\lambda_2, \dots, 2\lambda_k)$ for some $\lambda \vdash n$. The perfect matching association scheme is simply the collection of $\mathcal{M}_{2n} \times \mathcal{M}_{2n}$ matrices $\mathcal{A} := \{A_\lambda\}_{\lambda \vdash n}$ defined such that $(A_\lambda)_{ij} = 1$ if $i \cup j \cong 2\lambda$; otherwise, 0.

Proposition 3.7. $\mathbf{M} \cong A_{(n)}$.

Since \mathcal{A} is a symmetric association scheme, the eigenspaces of the A_λ 's coincide, and are precisely the irreducibles in the decomposition given by Thrall [14]. In light of this, we can take the distinct eigenvalues of these matrices as column vectors and collect them in a $\lambda(n) \times \lambda(n)$ matrix P . For example, when $n = 4$, we have $\mathcal{A} = \{A_{(4)}, A_{(3,1)}, A_{(2,2)}, A_{(2,1^2)}, A_{(1^4)}\}$, and

$$P = \begin{matrix} & \begin{matrix} (4) & (3,1) & (2,2) & (2,1^2) & (1^4) \end{matrix} \\ \begin{matrix} (4) \\ (3,1) \\ (2,2) \\ (2,1^2) \\ (1^4) \end{matrix} & \begin{bmatrix} 48 & 32 & 12 & 12 & 1 \\ -8 & 4 & -2 & 5 & 1 \\ -2 & -8 & 7 & 2 & 1 \\ 4 & -2 & -2 & -1 & 1 \\ -6 & 8 & 3 & -6 & 1 \end{bmatrix} \end{matrix}.$$

For any $\lambda \vdash n$, we call $\Omega_\lambda := \{m \in \mathcal{M}_{2n} : m \cup m^* \cong 2\lambda\}$ the λ -~~block~~, where

$$m^* = \{\{1, 2\}, \{3, 4\}, \dots, \{2n-1, 2n\}\}.$$

The following lemma gives a simple way to determine their size.

Lemma 3.8 ([22]). ~~Let~~ $l(\lambda)$ ~~be the~~ $\lambda \vdash n$, m_i ~~be the~~ i , ~~and~~ $z_\lambda := \prod_{i \geq 1} i^{m_i} m_i!$.

$$|\Omega_\lambda| = \frac{2^n n!}{2^{l(\lambda)} z_\lambda}.$$

Note that the first row of P lists the sizes of the respective spheres. This is no coincidence, as each A_λ has constant row sum $|\Omega_\lambda|$, and so its largest eigenvalue is $|\Omega_\lambda|$ respectively [15].

It is known that the entries of P are determined by the ~~entries~~ [28, Chapter VII], which can be thought of as an analogue of irreducible characters in our association scheme setting.

Theorem 3.9 ([28]). $\eta_\lambda = \sum_{c \in \lambda \vdash n} \frac{1}{n(c)} \omega_\lambda^{(n)}$

$$\eta_\lambda = |\Omega_\lambda| \omega_\lambda^{(n)}.$$

A result of Diaconis and Lander is the following explicit formula for determining the value of the zonal spherical function ω_λ evaluated on perfect matchings $m \in \Omega_{(n)}$.

Lemma 3.10 (Diaconis & Lander [28]). $\omega_\lambda^{(n)} = \frac{1}{2^{n-1}(n-1)!} \sum_{\substack{c \in \lambda \\ c \neq (1,1)}} (2w(c) - n(c))$

$$\omega_\lambda^{(n)} = \frac{1}{2^{n-1}(n-1)!} \sum_{\substack{c \in \lambda \\ c \neq (1,1)}} (2w(c) - n(c)),$$

$\omega_\lambda^{(n)} = 0$ if $\lambda \neq (2^3)$. (1, 1). η_λ

We are now in a position to prove Theorem 3.4.

By Proposition 3.7, we have $\mathbf{M} = A_{(n)}$. Theorem 3.9 and Lemma 3.10 together imply that nonzero eigenvalues of \mathbf{M} do not cover (2^3) . Lemma 3.8 implies that spheres are nonempty, thus these are precisely the nonzero eigenvalues of \mathbf{M} . By Proposition 3.2 and Theorem 3.5, the dimension of the eigenspace corresponding to η_λ is $f^{2\lambda}$, completing the proof. \square

Counting Young tableaux. Our combinatorial formula for the rank of the matchings connectivity matrix does not seem to admit any particularly revealing closed-form; nevertheless, we can still get a good lower bound on its rank. We say that $2\lambda \vdash 2n$ such that $\lambda \vdash n$ is a domino hook if $\lambda = (k, k, 1^{n-2k})$ for some $0 \leq k \leq n$. For example,

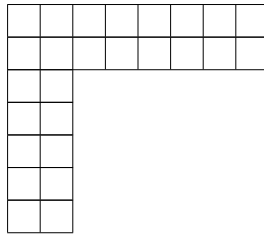

is the Ferrers diagram of the domino hook $2(4, 4, 1^5)$. Note that if $2\lambda \vdash 2n$ is a domino hook, then λ does not cover (2^3) . Using WZ-theory [31], Regev showed that the number of standard Young tableaux of domino hook shape admits an elegant count. Recall that $C_n = \frac{1}{n+1} \binom{2n}{n}$ is the n th Catalan number, and that $\lim_{n \rightarrow \infty} ((4^n / \sqrt{\pi n^{3/2}}) / C_n) = 1$ [36].

Theorem 3.11 (Regev [2]).

$$C_{n-1}C_n = \sum_{\substack{2\lambda \vdash 2n \\ \lambda \text{ domino hook}}} f^{2\lambda}.$$

Now we can combine all work and finish the proof:

~~the~~ ~~fit~~

We have by Theorem 3.4 that

$$\text{rank } \mathbf{M} = \sum_{\substack{\lambda \vdash n \\ \lambda \text{ does not cover } (2^3)}} f^{2\lambda} \geq \sum_{\substack{2\lambda \vdash 2n \\ 2\lambda \text{ domino hook}}} f^{2\lambda} = C_{n-1}C_n \geq 4^n/n^3,$$

where the inequality follows because if $2\lambda \vdash 2n$ is a domino hook, then λ does not cover (2^3) . \square

Note that by the aforementioned upper bound of $\frac{1}{2} \binom{2n-2}{n-1} \binom{2n}{n}$, the lower bound is almost tight.

4 The reduction

This section is devoted to the proof of Theorem 1.2. We will show the following stronger lemma:

Lemma 4.1. ~~The~~ ~~pathwidth~~ $r_p = \lim_{\beta \rightarrow \infty} \log_2(\text{rank}_p(\mathbf{M}_\beta))/\beta$. ~~is~~ $O^*((2 + r_p - \varepsilon)^{\text{pw}})$ ~~for~~ $\varepsilon > 0$. ~~This~~ $O^*((2 - \varepsilon')^n)$ ~~holds~~ $\varepsilon' > 0$ ~~if~~ ε .

Lemma 4.1 is a generalization of Theorem 1.2 as in SETH we can without loss of generality assume the number of satisfying solutions is at most one as mentioned in Section 2, so for the decision version we can simply check whether the modular count equals 1 or not. Lemma 4.1 will be used to prove Theorem 1.2. It should be noted that many of the gadgets used in the non-innovative parts of this section are heavily based on the lower bound for the decision version from [11].

Organization of this section The proof of Lemma 4.1 will be divided into several subsections. The key innovative insight will be presented in Subsection 4.1, in which we state Lemma 4.2, which is the main workhorse of the proof. The proof of Lemma 4.2 itself will be by induction and is divided into the inductive step, which requires new insights and is presented in Subsection 4.1, and the base step. The base step requires technical (and more routine) work with gadgets. These gadgets will be shown in Subsection 4.2, and afterwards used to prove the base step in Subsection 4.3. Finally, in Subsection 4.4, we show how Lemma 4.2 implies Lemma 4.1. For this, we will need some ideas similar to the proof of the inductive step, and we need to set various parameters that link the rank of the matrix \mathbf{M} to the pathwidth of the constructed graph.

Illustrated outline of proof Before describing the reduction in detail, we first provide an illustrated outline of the proof. For this, a basic understanding of previous block propagation schemes as outlined in Section 1 will be advantageous. We start with a high level description of the statement of Lemma 4.2. The 2^n assignments of the variables of the given CNF-formula φ are encoded by fingerprints that form a basis in the matrix \mathbf{H}_k . The larger such a basis, the more assignments one can encode for fixed k . Lemma 4.2 asserts the existence of a certain graph G in which the number of partial solutions of a given fingerprint equals 0 if the fingerprint encodes an assignment not satisfying φ and a fixed positive quantity (depending on the fingerprint) otherwise. The boundary vertices L and R are partitioned into blocks and the fingerprints will also have some block-structure for technical reasons reminiscent to the block-propagation scheme. Confer the statement of Lemma 4.2 for the precise details.

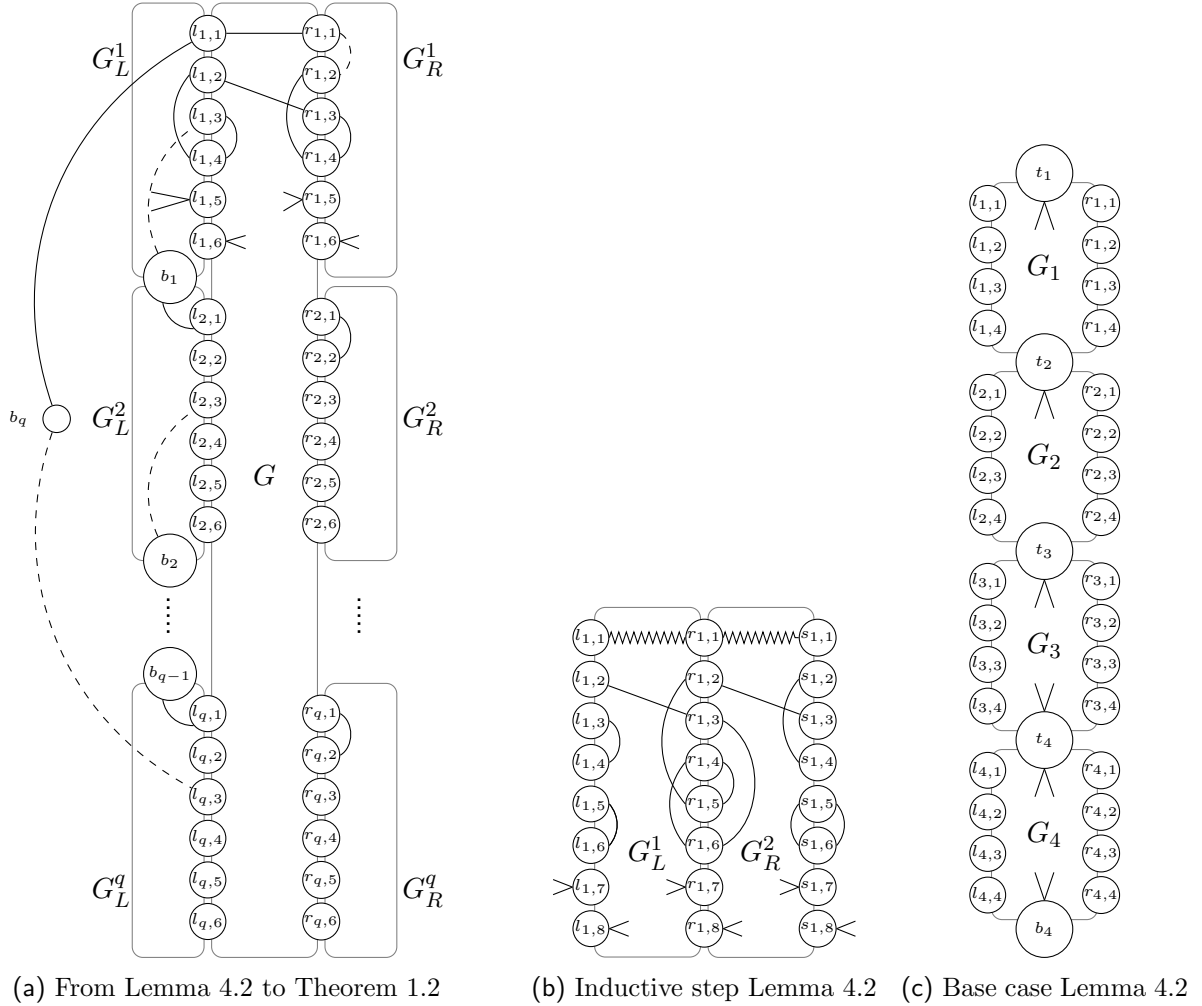

Fig. 3: Illustrations of parts of the proof of Theorem 1.2

In Figure 3a, we illustrate how the graph output by the reduction implied by Lemma 4.1 is obtained from the graph G obtained by Lemma 4.2: The \mathbf{b} G_L^i and G_R^i (whose unions we jointly denote by G_L respectively G_R) are added to G , where G_R^i has vertex set R_i common with G , and G_L^i has vertex set L_i common with G . Additionally, graphs G_L^i and G_L^{i+1} share a common vertex b_i . By Lemma 4.2, the graph G has $\mathbf{A}[f_L, f_R]$ partial solutions for fingerprints f_L and f_R . The graph G_L has \mathbf{l}_f fingerprints and $\mathbf{r}_{f'}$ fingerprints such that $\mathbf{l}^T \mathbf{A} \mathbf{r}$ equals the number of satisfying solutions of φ modulo p . To establish this, for each fingerprint, certain partial solutions are allowed such that two edgesets avoid creating subcycles only if they have combining fingerprints on L (or R). The structure of the partial solutions is tailored such that combinations of partial solutions with combining fingerprints can be extended in one (modulo p) way into a Hamiltonian cycle. For the latter part, the vertices b_i are used to connect parts from the subgraphs G_L^i . In Figure 3a, the edges present in all partial solutions are displayed everywhere (where dashed edges will actually be redirected to visit vertices with degree 0 or 2 in a fingerprint), and on the vertices $L_i \cup R_i$, a possible partial solution in G_L^i, G, G_R^i is displayed. The edges $l_{i,1}l_{i,2}$ and $r_{i,1}r_{i,3}$ in G are rerouted to avoid creating two subcycles if two matchings give exactly one cycle. If the fingerprint in both G_L^i and G_R^i matches with the fingerprint in G , $l_{i,1}$ will be connected to $r_{i,1}$ and $l_{i,2}$ will be connected to $r_{i,2}$.

In Figure 3b, we illustrate the inductive step of the proof of Lemma 4.2. This lemma states that, for a CNF-formula $\varphi = C_1 \wedge \dots \wedge C_m$ on m clauses, there exists a graph such that the number of partial solutions for certain fingerprints encodes the number of satisfying assignments of φ . The proof of this lemma is by induction on m , so in the inductive step, we assume a graph G_L is given for $\varphi' = C_1 \wedge \dots \wedge C_{m-1}$, and a graph G_R for the CNF-formula C_m . The graphs G_L and G_R have a certain block structure consisting of smaller graphs G_L^i and G_R^i , which allows us to basically restrict attention to one block (i.e., a fingerprint of one block encodes a partial assignment of a block of variables).⁴ Suppose the graphs G_L^i and G_R^i have boundary vertices $L \cup R$ and $R \cup S$ respectively. Then we can see these graphs as matrices \mathbf{L} and \mathbf{R} of which an entry indexed by f, f' equals the number of partial solutions on fingerprints f, f' in G_L^i (in which case f is on L and f' is on R), and respectively the number of partial solutions on fingerprints f, f' in G_R^i (in which case f is on R and f' is on S). Note the fingerprint of the partial solution in G_L^i on R and the fingerprint of G_R^i on R also need to match as otherwise the union cannot give a partial solution in the graph $G^i \cup G_R^i$, and by our construction two partial solutions with matching fingerprint on R are also a partial solution of $G^i \cup G_R^i$. It follows that if we let \mathbf{A} be the number of partial solutions in $G^i \cup G_R^i$ indexed by fingerprint f_L on L and f_R on R , then this matrix can be computed as the matrix multiplication $\mathbf{L}\mathbf{R}$, where \mathbf{F} is a full rank submatrix of the Hamiltonian fingerprint matrix by a set of fingerprints that we restrict ourselves to. By using gadgets to ensure that $\mathbf{L} = \mathbf{C}\mathbf{F}^{-1}$ where \mathbf{C} is a diagonal matrix checking whether the assignment satisfies φ' the inductive step can be carried out. In Figure 3b the showed partial solution in G_L^1 is derived from the fingerprint $f_L = (d_L, M_L)$ in G_L^1 with $d_L^{-1}(1) = \{l_{1,i}\}_{i=1}^6$, $d_L^{-1}(2) = \{l_{1,8}\}$, $d_L^{-1}(0) = \{l_{1,7}\}$ and $M_L = \{l_{1,1}l_{1,2}, l_{1,3}l_{1,4}, l_{1,5}l_{1,6}\}$ on L and from the fingerprint $f_R = (d_R, M_R)$ in G_L^1 with $d_R(v) = 2 - d_L(v)$, and $M_R = \{r_{1,1}r_{1,3}, r_{1,2}r_{1,5}, r_{1,4}l_{1,6}\}$ on L . If this (or a fingerprint of another block) encodes a partial assignment satisfying φ' , there will be $\mathbf{F}^{-1}[f_L, f_R]$ partial solutions with fingerprint $f_L \cup f_R$ in G_L^1 .

In Figure 3c we illustrate the base case of the proof of Lemma 4.2. The graph is partitioned into

⁴ This is not completely true, as partial assignments must interact to check whether any partial assignment satisfies a clause, but this does not turn out problematic.

q blocks G_1, \dots, G_q (with $q = 4$) in the example, and a fingerprint on $L_i = \{l_{i,j}\}_{j \leq \beta}$ encodes a partial assignment of a block of variables of the CNF-formula, which we consider to be a single clause as $m = 1$ in the base case of the induction. A graph G_i contains a top vertex t_i and bottom vertices b_i , and the consecutive graphs overlap in the sense that $b_{i+1} = t_i$. Partial solutions are locally (that is, per G_i) restricted such that i is the smallest integer with the property that the partial solution encodes a fingerprint satisfying the clause if and only if the partial solution in G_i has a fingerprint in which both t_i and b_i are of degree 2.

4.1 Pattern propagation using a rank lower bound

Let $\gamma := \gamma(\varepsilon) \geq 4$ be even. Assume we are given a CNF-formula $\phi = C_1 \wedge \dots \wedge C_m$ on variables x_1, \dots, x_n with n being a multiple of γ ;⁵ let $q = \frac{n}{\gamma}$. Partition the set $\{x_1, \dots, x_n\}$ into n/γ blocks of size γ , denoted $X_1, \dots, X_{n/\gamma}$. Intuitively, we represent the 2^γ assignments of a block of variables by HC-fingerprints on groups of vertices in a bag of the to be constructed path decomposition. We let $\mathcal{B}_l, \mathcal{B}_r$ be sets of HC-fingerprints on $[\beta]$ such that $\mathbf{H}[\mathcal{B}_l, \mathcal{B}_r]$ has full rank over p and if $(d_l, M_r) \in \mathcal{B}_l$ and $(d_r, M_r) \in \mathcal{B}_r$ then

- $d_l(i), d_r(i)$ equal 1 for $i = 1, 2, 3$, and
- $\{1, 3\} \in M_l$ and $\{1, 2\} \in M_r$.

For $i = 1, \dots, q$ we assume η_i is an injective function from \mathcal{B}_r to $\{0, 1\}^{X_i}$ which describes the encoded partial assignment to the variable set X_i . Note this is only possible when $|\mathcal{B}_r| \geq 2^\gamma$, which we will ensure in Subsection 4.4 when wrapping up the proof of Theorem 1.2. In the following, we refer to $\mathbf{H}[\mathcal{B}_l, \mathcal{B}_r]$ as \mathbf{F} , and also frequently use the q -th Kronecker power $\mathbf{F}^{\otimes q}$. We also use \mathbf{F}^{-1} (which is indexed by \mathcal{B}_r and \mathcal{B}_l respectively) and its Kronecker power $(\mathbf{F}^{-1})^{\otimes q} = (\mathbf{F}^{\otimes q})^{-1}$.

Lemma 4.2. $L = L_1 \cup \dots \cup L_q, R = R_1 \cup \dots \cup R_q$ ~~with~~ $L_i = \{l_{i,1}, \dots, l_{i,\beta}\}$
 d $R_i = \{r_{i,1}, \dots, r_{i,\beta}\}$ ~~with~~ $G(L, R, \varphi) = (V, E)$ ~~with~~ $L \cup R \subseteq V$
~~with~~

$$f_L = ((d_L^i, M_R^i) \text{ on } L_i)_{i \in [q]} \quad f_R = ((d_R^i, M_R^i) \text{ on } R_i)_{i \in [q]},$$

$$\text{with } G \text{ with } f' = (\bigcup_{i=1}^q d_L^i \cup d_R^i, \bigcup_{i=1}^q M_{alt}^i) \text{ with}$$

$$\mathbf{A}[f_L, f_R] := \begin{cases} (\mathbf{F}^{\otimes q})^{-1}[f_L, f_R], & f \text{ } f_L \in \mathcal{B}_r^{\otimes q}, f_R \in \mathcal{B}_l^{\otimes q} \text{ with } \eta(f_L) \text{ is } \varphi, \\ 0, & \text{with} \end{cases}$$

$$\text{with } M_{alt}^i \text{ with } M_{alt}^i = M_L^i \cup M_R^i \setminus \{l_{i,1}l_{i,2}, r_{i,1}r_{i,3}\} \cup \{l_{i,1}r_{i,1}, l_{i,2}r_{i,3}\}. \\ \text{with } G \text{ with } \mathbb{P} \text{ with } \beta \cdot q + O(\beta) \text{ with } L \text{ with } R, d \\ G \text{ with } \mathbb{P} \text{ with}$$

It may look counterintuitive that $f_L \in \mathcal{B}_r^{\otimes q}$, but note that the subscripts l and r denote that fingerprints in \mathcal{B}_l will be used for partial solutions connecting vertices ‘to the left’ of a certain vertex boundary, while fingerprints in \mathcal{B}_r will be used for partial solution ‘to the right’ of a certain boundary (see Figure 3b). As L is the ‘left boundary’ of G connection made in G between vertices in L will be ‘to the right’ of L so the matchings will be in \mathcal{B}_r .

⁵ Note that since γ is a constant this is easily established by adding at most γ dummy variables.

We will prove Lemma 4.2 by induction on m . The bulk of our technical efforts with gadgets will be to prove the following lemma for $m = 1$. On the other hand, for proving the inductive case our new key insight of applying matrix inversion is crucial. We postpone the technical proof of the base case $m = 1$ to Subsection 4.3 and first focus on the inductive case.

~~Proof.~~ Let $\varphi = C_1 \wedge \dots \wedge C_m$ be a CNF formula on n variables and $\varphi' = C_1 \wedge \dots \wedge C_{m-1}$. Let $L = L_1 \cup \dots \cup L_q$, $R = R_1 \cup \dots \cup R_q$, $S = S_1 \cup \dots \cup S_q$ be disjoint sets with $L_i = \{l_{i,1}, \dots, l_{i,\beta}\}$, $R_i = \{r_{i,1}, \dots, r_{i,\beta}\}$ and $S_i = \{s_{i,1}, \dots, s_{i,\beta}\}$. Let $\hat{G} = (\hat{V}, \hat{E}) = G(L, R, \varphi')$ and $\tilde{G} = (\tilde{V}, \tilde{E}) = G(R, S, C_m)$ be graphs as given by the induction hypothesis.

Define $G = (\hat{V} \cup \tilde{V}, \hat{E} \cup \tilde{E})$. We show G satisfies the conditions of Lemma 4.2 with φ , as required to prove the inductive case. Note that $\hat{E} \cap \tilde{E} = \emptyset$ as $\hat{V} \cap \tilde{V} = R$ is an independent set in both graphs. As $\hat{V} \cap \tilde{V} = R$, the path decomposition of \hat{G} ending in R and the path decomposition of \tilde{G} starting in R can clearly be combined into a path decomposition of G of the same width. It remains to show that for every sequence of fingerprints

$$f_L = ((d_L^i, M_L^i) \text{ on } L_i)_{i \in [q]} \text{ and } f_S = ((d_S^i, M_S^i) \text{ on } S_i)_{i \in [q]},$$

the number of partial solutions H in G for fingerprint $f = (\bigcup_{i=1}^q d_L^i \cup d_S^i, \bigcup_{i=1}^q M_{alt}^i)$ equals

$$\begin{cases} (\mathbf{F}^{\otimes q})^{-1}[f_L, f_S], & \text{if } f_L \in \mathcal{B}_r^{\otimes q}, f_S \in \mathcal{B}_l^{\otimes q} \text{ and } \eta(f_L) \text{ satisfies } \varphi, \\ 0, & \text{otherwise.} \end{cases} \quad (2)$$

Here $M_{alt}^i = M_L^i \cup M_S^i \setminus \{l_{i,1}l_{i,2}, s_{i,1}s_{i,3}\} \cup \{l_{i,1}s_{i,1}, l_{i,2}s_{i,3}\}$. To show this, we first show the following claim:

Claim 1. ~~Every~~ G ~~with~~ fingerprint f

$$\sum_{\substack{\hat{f}_R \in \mathcal{B}_l^{\otimes q}, \tilde{f}_R \in \mathcal{B}_r^{\otimes q} \\ \eta(\hat{f}_L) \models \varphi', \eta(\tilde{f}_R) \models C_m}} (\mathbf{F}^{\otimes q})^{-1}[f_L, \hat{f}_R] \cdot \mathbf{F}^{\otimes q}[\hat{f}_R, \tilde{f}_R] \cdot (\mathbf{F}^{\otimes q})^{-1}[\tilde{f}_R, f_S].$$

~~Proof.~~ Let H be a partial solution in G for fingerprint f , let $\hat{H} = H \cap \hat{E}$ and $\tilde{H} = H \cap \tilde{E}$. By construction of \hat{G} and \tilde{G} , \hat{H} is a partial solution in \hat{G} for \hat{f} and \tilde{H} is a partial solution in \tilde{G} for \tilde{f} where

$$\hat{f} = \left(\bigcup_{i=1}^q d_L^i \cup d_R^i, \bigcup_{i=1}^q \hat{M}_{alt}^i \right), \quad \tilde{f} = \left(\bigcup_{i=1}^q d_R^i \cup d_S^i, \bigcup_{i=1}^q \tilde{M}_{alt}^i \right),$$

and the altered matchings are defined as

$$\begin{aligned} \hat{M}_{alt}^i &= \hat{M}_L^i \cup \hat{M}_R^i \setminus \{l_{i,1}l_{i,2}, r_{i,1}r_{i,3}\} \cup \{l_{i,1}r_{i,1}, l_{i,2}r_{i,3}\}, \\ \tilde{M}_{alt}^i &= \tilde{M}_R^i \cup M_S^i \setminus \{r_{i,1}r_{i,2}, s_{i,1}s_{i,3}\} \cup \{r_{i,1}s_{i,1}, r_{i,2}s_{i,3}\}. \end{aligned}$$

As H is a partial solution in G we have $d_H(v) = 2$ for all vertices in $v \in R$ and thus $\hat{d}_R^i(j) + \tilde{d}_R^i(j) = 2$ for every i, j . Moreover, H cannot contain a cycle as it is a partial solution and therefore $\hat{M}_{alt}^i \cup \tilde{M}_{alt}^i$ cannot contain a cycle for every $i = 1, \dots, q$. It follows that $\hat{M}_R^i \cup \tilde{M}_R^i$ must form a single cycle: if not, it contains at least two cycles as $\hat{M}_R^i \cup \tilde{M}_R^i$ are perfect matchings on the same set of vertices, and a cycle not containing the vertex $r_{i,1}$ will still be present in $\hat{M}_{alt}^i \cup \tilde{M}_{alt}^i$. Thus in summary we

have that if \hat{H} is a partial solution in \hat{G} for fingerprint $\hat{f}_R = (\cup_{i=1}^q \hat{d}_R^i, \cup_{i=1}^q \hat{M}_R^i)$ on R and is \tilde{H} is a partial solution in \tilde{G} for fingerprint $\tilde{f}_R = (\cup_{i=1}^q \tilde{d}_R^i, \cup_{i=1}^q \tilde{M}_R^i)$ on R , then $\mathbf{F}^{\otimes q}[\hat{f}_R, \tilde{f}_R] = 1$.

For the reverse direction we have that if $\mathbf{F}^{\otimes q}[\hat{f}_R, \tilde{f}_R] = 1$, by the definition of the altered matchings H indeed has fingerprint $f = (\cup_{i=1}^q \hat{d}_L^i \cup \tilde{d}_S^i, \cup_{i=1}^q M_{alt}^i)$ where

$$M_{alt}^i = \hat{M}_L^i \cup \tilde{M}_S^i \setminus \{l_{i,1}l_{i,2}, s_{i,1}s_{i,3}\} \cup \{l_{i,1}s_{i,1}, l_{i,2}s_{i,3}\}.$$

To see this, note that in H , $l_{i,1}$ is (directly via \hat{M}_{alt}^i) connected to $r_{i,1}$ which is (directly via \tilde{M}_{alt}^i) connected to $s_{i,1}$, and $l_{i,2}$ is (directly via \hat{M}_{alt}^i) connected to $r_{i,3}$ which is (indirectly via the path $(\hat{M}_{alt}^i \cup \tilde{M}_{alt}^i) \cap R \times R$) connected to $r_{i,2}$ which is (directly via \tilde{M}_{alt}^i) connected to $s_{i,3}$.

The claim follows by summing over all possibilities of \hat{f}_R and \tilde{f}_R such that $\eta(\hat{f}_L) \models \varphi'$ and $\eta(\tilde{f}_R) \models C_m$ (the latter two properties follow by the properties of \tilde{G} and \tilde{G}). \square

By Claim 1 the number of partial solutions in G for fingerprint f equals $\mathbf{A}[f_L, f_S]$, where

$$\mathbf{A} = \mathbf{C}(\mathbf{F}^{\otimes q})^{-1} \mathbf{F}^{\otimes q} \mathbf{C}' (\mathbf{F}^{\otimes q})^{-1} = \mathbf{C} \mathbf{C}' (\mathbf{F}^{\otimes q})^{-1},$$

and \mathbf{C}, \mathbf{C}' are diagonal matrices defined by

$$\mathbf{C}[f, f'] = \begin{cases} 1, & \text{if } f = f' \text{ and } \eta(f) \models \varphi \\ 0, & \text{otherwise} \end{cases}, \text{ and } \mathbf{C}'[f, f'] = \begin{cases} 1, & \text{if } f = f' \text{ and } \eta(f) \models C_m \\ 0, & \text{otherwise} \end{cases}.$$

and the inductive step follows as $\mathbf{A}[f_L, f_S]$ equals (2). \square

4.2 Gadgets

In this section we introduce two general gadgets, adapted from previous constructions [11], that are used in the final construction to obtain strong control on the number of Hamiltonian cycles. Both gadgets accept parameters to be set in the final construction.

Label Gadget. The following gadget allows us to label incident edges of a vertex v and control label combinations of the edges used in a Hamiltonian cycle.

Definition 4.3. A label gadget \mathfrak{L} is a graph (v, λ_v) with $\lambda_v : I(v) \rightarrow \{1, 2, 3, 4\}$ and a set of edges E with $\lambda_v(e) = 2i$ and $\lambda_v(e') = 2i - 1$ for $i \in \{1, 2\}$. The gadget is consistent if C is consistent. The gadget is C -consistent if C is consistent.

When we use several label gadgets simultaneously, there will be several labelings and we say an e edge has label l with respect to v if $\lambda_v(e) = l$. We will now show how to replace a label gadgets in a graph G with a certain graph to obtain G' such that the number of Hamiltonian cycles in G' equals the number of Hamiltonian cycles in G consistent (v, λ_v) . The graph is shown at the left-hand side in Figure 4. That is, the vertex v is replaced by the displayed graph on vertices v_1, \dots, v_9 and each edges with label $i = 1, \dots, 4$ is connected to v_i . We have to ensure that any Hamiltonian cycle contains exactly two edges of the set of edges leaving the gadget and that these have either labels 1 and 2 or labels 3 and 4, and this can be seen to hold by a simple case analysis: If the cycle enters the gadget in vertex v_1 , it must continue with v_5, v_3 . Then it cannot leave the gadget, because then it is impossible to visit all six remaining vertices. Hence it must continue with v_8 and then v_7, v_6, v_4, v_9 , and v_2 are forced and the cycle uses edges labeled with 1 and 2. The cases where it enters at a different vertex are symmetric.

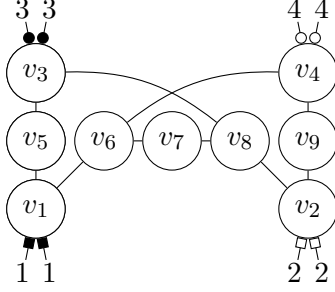

Fig. 4: Implementation of label gadget. The 4 labels $\{1, 2, 3, 4\}$ are depicted symbolically with \blacksquare , \square , \bullet , and \circ respectively for reference in Figure 5.

Fingerprint Gadget. Now we present a general gadget allowing strong control on the fingerprints of partial solutions. If B is a set of vertices, we let \mathcal{P}_B denote the set of all HC-fingerprints on B .

Definition 4.4 (Fingerprint Gadget). A fingerprint gadget with boundary B is a graph $G' = (V', E')$ with $B \subseteq V'$ and a function $f \in \mathcal{P}_B$ such that $G' \models f$ and m_f .

Lemma 4.5 (Fingerprint Gadget Implementation). Let $G, B, \{m_f\}_{f \in \mathcal{P}_B}$ such that $a, b \in B$ and $f = (d, M)$ with $m_f \neq 0$ and $ab \in M$.⁶ Then there exists a graph G' with B such that $O(|B| \sum_{f \in \mathcal{P}_B} m_f) \leq |B| + O(1)$.

We start with a formal definition of the graph $G' = (V', E')$, which we define using label gadgets. An illustrative example is provided in Figure 5.

1. Add to V' the set B and additionally two vertices a' and c . Add a subdivided edge aa' .⁷
2. Let $(f_i = (d_i, M_i))_{i=1}^{\ell}$ be a sequence of fingerprints that contains each $f \in \mathcal{P}_B$ exactly m_f times, so $\ell = \sum_{f \in \mathcal{P}_B} m_f$.
3. For $i = 1, \dots, \ell$:
 - (a) Let $d_i^{-1}(2) = \{t_i^1, \dots, t_i^k\}$ be the vertices of degree 2 in d_i .
 - (b) Define a sequence of edges $E_i = (e_i^j)_{j=i}^{\ell_i}$ to be an arbitrary ordering of the union of the edgeset of a path from a' through $d_i^{-1}(2)$ to c and the edgeset $M_i \setminus ab$.
 - More formally, let $e_i^1 = a't_i^1$; for $j = 1, \dots, k - 1 = |d_i^{-1}(2)| - 1$ let $e_i^{j+1} = t_i^j t_i^{j+1}$; let $e_i^{k+1} = t_i^k c$, and let $\{e_i^{k+2}, \dots, e_i^{\ell_i}\} = M_i \setminus ab$, where $\ell_i = k + 1 + |M_i|$.
 - (c) For $j = 1, \dots, \ell_i$:
 - Let $e_i^j = uv$. Add a 4-label gadget p_i^j with incident edges $p_i^j u$ with label 1 and $p_i^j v$ with label 2.

⁶ These are just technical conditions to facilitate the implementation of this gadget.

⁷ Formally, add another vertex a'' with only a and a' as neighbors. Here a'' is a vertex of degree 2 with the sole purpose of enforcing the edges $a'a''$ and $a''a'$ to be in a Hamiltonian cycle.

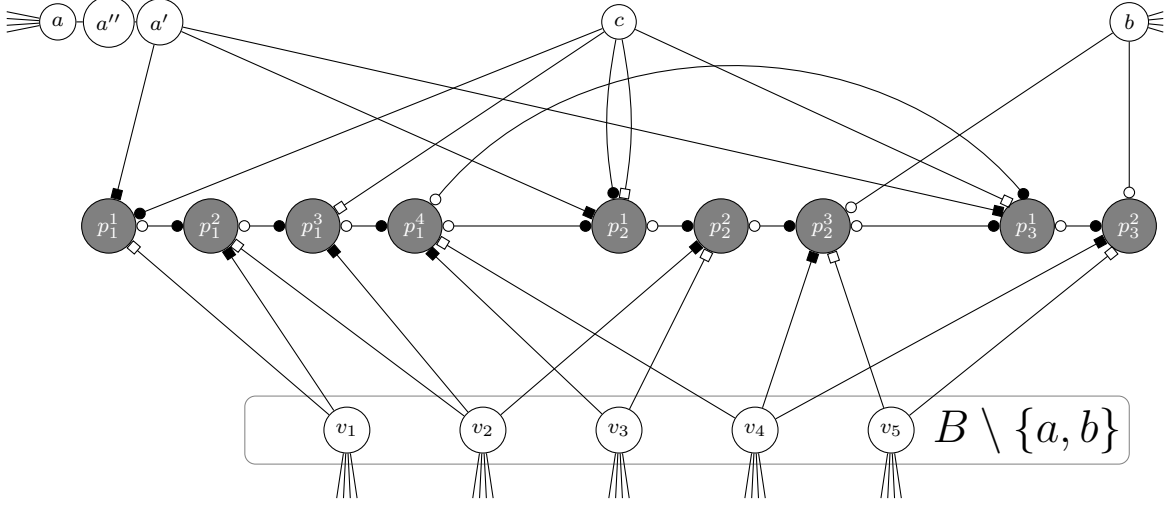

Fig. 5: Example of the fingerprint gadget. Here $B = \{v_1, \dots, v_5, a, b\}$ and m_f equals one for $f = f_i = (d_i, M_i)$ (described in the next line), and zero otherwise. The vertices p_i^j represent fingerprint f_i . Here $d_1^{-1}(2) = \{v_1, v_2\}$, $M_1 = \{ab, v_3v_4\}$; $d_2^{-1}(2) = \emptyset$, $M_2 = \{ab, v_2v_3, v_4v_5\}$; $d_3^{-1}(2) = \emptyset$, $M_3 = \{ab, v_4v_5\}$. The vertices p_i^j are label gadgets, and the symbols denote the labels 1, 2, 3, 4 as in Figure 4.

- (d) If $i > 1$, add an edge $e = uv = p_{i-1}^{\ell_{i-1}} p_i^1$ with $\lambda_u(e) = 4$ and $\lambda_v(e) = 3$.
- (e) If $i > 2$, add an edge $e = uv = p_{i-2}^{\ell_{i-2}} p_i^1$ with $\lambda_u(e) = 4$ and $\lambda_v(e) = 3$.
- 4. For $i = 1, 2$, add an edge $e = uv = cp_1^i$ with $\lambda_v(e) = 3$.
- 5. For $i = \ell - 1, \ell$, add an edge $e = uv = p_i^{\ell_i} b$ with $\lambda_u(e) = 4$.

Correctness. Let H be a partial solution in G' consistent with all label gadgets. Note that H contains the edges aa'' and $a''a'$ as a'' has degree 2. Thus we see that a' needs to be adjacent in H to p_x^1 for exactly one chosen x , as this vertex has no other neighbors. We claim that for every x there is exactly one partial solution containing the edge $a'x$ and this partial solution has fingerprint f_x . Note this is sufficient to prove the lemma, as it implies we have m_f choices for x that lead to fingerprint f .

To this end, suppose that H contains the edge $a'p_x^1$, and let $i \neq x$. Then H cannot contain an edge e incident to p_i^1 satisfying $\lambda_{p_i^1}(e) \in \{1, 2\}$ by the definition of a label gadget as it only has one edge not incident to a' with such a label. Thus H needs to contain edges incident to p_i^1 with labels 3 and 4 with respect to p_i^1 . But the only edge with label 4 is to p_i^2 (if it exists) which has label 4 with respect to p_i^2 . By propagation it follows that in H we have that for every p_i^j the two edges incident to p_i^j must have label 3 and 4 with respect to p_i^j .

Now we focus on $p_x^1, \dots, p_x^{\ell_x}$. We see that p_x^2 (if it exists) has only one incident edge with label 3 (with respect to p_x^2) which is to p_x^1 . Therefore the edges of H incident to p_x^2 must have labels 1 and 2, and the same holds by propagation for all p_x^j . It follows that H has fingerprint f_x : every vertex in $d_x^{-1}(2)$ has indeed degree 2 as it is incident to two edges in E_x , no edges incident to vertices in $d_x^{-1}(0)$ occur in H as they do not occur in E_x so they are not adjacent to the vertices p_x^i , which

are the only vertices with incident edges with label 1 or 2. Moreover, for all edges in $uv \in M_i \setminus ab$ we see H has the path up_x^j, p_x^jv as the edges incident to p_x^j must have labels 1 and 2.

Summarizing, we saw that H must contain the paths $p_i^1, \dots, p_i^{\ell_i}$ for $i \neq x$ and all edges with labels 1 and 2 with respect to vertices p_x^j , and if it does it has the correct fingerprint if a and b are connected to each other. It remains to show that (without creating subcycles) the paths can be connected to one path from a to b visiting all vertices $V' \setminus (B \cup \{p_x^{1+|d_x^{-1}(2)|}, \dots, p_x^{\ell_i}\})$ in a unique way. To see that this is the case, first note that a' is connected to c via the edges e_x^1, \dots, e_x^{k+1} where $k = d_x^{-1}(2)$ so they are also connected in G' via the vertices p_x^1, \dots, p_x^{k+1} . To connect the paths $p_i^1, \dots, p_i^{\ell_i}$ for $i \neq x$, note that $p_i^{\ell_i}$ can only be connected to vertices $p_{i'}^j$ with $i' > i$ as an incident edge of label 4 must be chosen. It follows that the only way to complete the paths is to connect

- c to p_1^1 if $x \neq 1$ or to p_2^1 if $x = 1$,
- $p_i^{\ell_i}$ to
 - p_{i+1}^1 , if $x \neq i+1$ and $i < \ell$,
 - p_{i+2}^1 , if $x = i+1$ and $i < \ell - 1$,
 - b , if $x = i+1$ and $i = \ell - 1$,
 - to b if $i = \ell$,

which connects a to b , as required.

Path Decomposition and Size. The claimed size bound holds trivially as all label gadgets are of constant size. For the pathwidth bound, note that after removing $B \cup \{a, b\}$ the graph induced on the vertices p_i^j has constant pathwidth as for every i we have that $\{p_i^{\ell_i}, p_{i+1}^1\}$ forms a separator separating $p_{i'}^j$ with $i' \leq i$ from $p_{i'}^j$ with $i' > i$, and the graph between separators $\{p_i^{\ell_i}, p_{i+1}^1\}$ and $\{p_{i-1}^{\ell_{i-1}}, p_i^1\}$ has clearly constant pathwidth as it is a path of label gadgets, which each are of constant size. The required path decomposition can thus be easily obtained by including B in every bag. \square

4.3 The base case of Lemma 4.2

We prove Lemma 4.2 for $m = 1$, so the CNF-formula is a single clause C_1 . The graph output by the reduction will consist of a graphs G_i for $1 \leq i \leq q$ (recall $q = n/\gamma$). Each G_i contains ‘left boundary vertices’ L_i , and ‘right boundary vertices’ R_i , and additionally a ‘top vertex’ t_i and ‘bottom vertex’ b_i . The graphs G_i are glued together by unifying $b_i = t_{i-1}$ to get the graph G . The vertices t_i and b_i will be used to propagate whether an encoded partial assignment has already satisfied the clause. We now define the graph G_i . Recall from Subsection 4.1 that η_i is a surjective function from \mathcal{B}_r to $\{0, 1\}^{X_i}$.

Definition 4.6. $L = L_i, R = R_i, t = t_i, b = b_i$. $f_L = (d_L, M_L) \in \mathcal{B}_r$, $f_R = (d_R, M_R) \in \mathcal{B}_l$, $M_{alt}^i = M_L^i \cup M_S^i \setminus \{l_{i,1}l_{i,2}, r_{i,1}r_{i,3}\} \cup \{l_{i,1}r_{i,1}, l_{i,2}r_{i,3}\}$. $B = L \cup R \cup \{b, t\}$, $f = (d_L \cup d_R \cup d_b \cup d_t, M_{alt}^i)$, $m_f = \mathbf{F}^{-1}[f_L, f_R]$, $f = f_L \cup f_R \cup d_b \cup d_t$.

$\eta_i(f_L)$ X_i C_1, d

$$\begin{aligned}
& (\emptyset \quad d_t = d_b = 2, \mathbf{v} \\
& (\emptyset \quad \mathbf{b} \quad d_b = 2 \quad \mathbf{d} \quad d_t = 0 \quad \mathbf{b} \\
2 \quad \eta_i(f_L) \text{ is not } & \quad X_i \text{ is not } & \quad C_1, \mathbf{d} \\
& (\emptyset \quad \mathbf{b} \quad \mathbf{d} \quad \mathbf{b} \\
& \quad d_t = 2 \quad \mathbf{d} \quad d_b = 2 \quad \mathbf{b}
\end{aligned}$$

~~Proof (sketch)~~ We claim that the graph G has the properties of Lemma 4.2. Let H have fingerprint f_L^i on L_i and f_R^i on R_i . Suppose that for every $i = 1, \dots, q$, the assignment $\eta_i(f_L^i)$ to X_i does not satisfy C_1 . Then exactly q of the vertices t_1, \dots, t_q, b_q will have 2 edges from H incident to it so one vertex will have no incident edges in H and therefore H cannot be a partial solution and does not contribute to the count.

Otherwise, let i be the smallest integer such that the assignment $\eta_i(f_L^i)$ to X_i satisfies C_1 . It follows that in fingerprint gadget G_i , H induces a partial solution for a fingerprint in which t_i and b_i both have degree 2. Therefore, in the fingerprint gadget $G_{i'}$ with $i' < i$, H induces a partial solution for a fingerprint in which t_i has degree 2 and b_i has degree 0. Similarly in the fingerprint gadget $G_{i'}$ with $i' > i$, H induces a partial solution for a fingerprint in which t_i has degree 0 and b_i has degree 2. Therefore, in this case the number of combinations of partial solutions of G_1, \dots, G_q with the combined fingerprint is thus $(\mathbf{F}^{-1})^{\otimes q}[f_L, f_R] = (\mathbf{F}^{\otimes q})^{-1}[f_L, f_R]$ by the constructions of the graphs G_i , as required.

Path Decomposition and Size. Let $L_0 = R_{q+1} = \emptyset$ for notational convenience. For $a = 0, \dots, q+1$, define

$$S_{<a} = \bigcup_{i=1}^{a-1} L_i \cup R_i \cup \{b_i, t_i\}, \quad S_a = b_a \cup t_a \cup \bigcup_{i=a}^q L_i \cup \bigcup_{i=1}^a R_i, \quad S_{>a} = \bigcup_{i=a+1}^q L_i \cup R_i \cup \{b_i, t_i\}.$$

Note that S_a is a separator separating all vertices from $S_{<a}$ from all vertices from $S_{>a}$. Moreover, S_0 contains L and S_{q+1} contains R . We construct a path decomposition containing the bags S_0, \dots, S_{q+1} in this order. It remains to show that this can be completed into a efficient path decomposition by adding an appropriate path decompositions between bags S_a and S_{a+1} . To see this note that the vertices not in $S_{<a}$ and $S_{>a}$ must be in G_a and G_a admits a path decomposition of width $|B| + O(1) = \beta + O(1)$ starting in L_a and ending in R_a by Lemma 4.5. Thus in between bags S_a and S_{a+1} we can add bags with S_a and the path decomposition of G_a ; after the last bag of this path decomposition we can forget all vertices of G_a except b_a and R_a which are contained in S_{a+1} . We obtain a pathdecomposition of width $q\beta + O(\beta)$, as required. \square

4.4 Putting things together to prove Lemma 4.1

~~Proof~~ We first finish off the construction of G . Let $G' = G(L, R, \varphi)$ as in Lemma 4.2. Then do the following for $i = 1, \dots, q$:

1. Add a fingerprint gadget G_i^R with boundary R_i to G' that has one partial solution for every fingerprint from \mathcal{B}_r on R_i .
2. Add vertices b_i, t_i to G' , where $b_i = t_{i+1}$ for $i < q$ and $t_q = b_1$.

3. Add a fingerprint gadget G_i^L with boundary $L_i \cup b_i \cup t_i$ to G' that has $\sum_{f^l \in \mathcal{B}_r} (\mathbf{F}^{\otimes q})^{-1}[f^l, f^a]$ partial solutions for fingerprint

$$f = (d', M \setminus l_{i,1}l_{i,3} \cup \{l_{i,1}t_i, l_{i,3}b_i\}),$$

where $f_i^a = (d, M) \in \mathcal{B}_l$ is a fingerprint on L_i , and d' equals d with the addition that $d(b_i) = d'(t_i) = 1$.

Number of solutions equals number of Hamiltonian cycles. Analogously to Claim 1, we first show the following:

Claim 2. ~~There is~~

G ~~is~~

$$\sum_{f^a, f^c \in \mathcal{B}_l^q, f^l, f^b, f^d \in \mathcal{B}_r^q} (\mathbf{F}^{\otimes q})^{-1}[f^l, f^a] \mathbf{F}^{\otimes q}[f^a, f^b] \mathbf{A}[f^b, f^c] \mathbf{F}^{\otimes q}[f^c, f^d]. \quad (3)$$

~~Proof~~ Denote G^L and G^R for the union of the graphs G_i^L and G_i^R , respectively. Let H be an edgeset with fingerprint constructed from $f^a = (f_1^a, \dots, f_q^a)$ in Step 3 on L in G^L , and fingerprint f_L on L in G' . By the construction of G' , the fingerprint f_L must be obtained from a fingerprint f_a by altering the matchings such that f_a and f_a match (indeed, as before, otherwise in one block two cycles will be created and one of them will contain the edge $l_{i,1}, l_{i,3}$ and thus not be altered so it remains a subcycle). Similarly, if H has fingerprint f_d on R in G^R and fingerprint f_R on R in G' , f_R must be obtained from a fingerprint f_c by altering the matchings such that f_c and f_d match.

Conversely we claim that, if H is an edgeset with fingerprints constructed from f^a in Step 3 on L in G^L , f_L on L in G' , f_d on R in G^R and a fingerprint obtained from f^c on R in G' by altering the matching, and both f^a and f^b as well as f^c and f^d match, then H is automatically a Hamiltonian cycle. To see this, first take into account the partial solution in G' and G^R . Similarly as in the proof of Claim 1, it is easily seen that this gives a set of paths that connect $l_{i,1}$ with $l_{i,2}$ for every i as the fingerprints f^c and f^d match. Taking also the partial solution in G^L into account and that f^a and f^b match, we see that within each block G_i^L the partial solutions connect t^i to b^i (denoting $t_i = b_q$) and therefore the partial solutions combined give a Hamiltonian cycle.

Therefore, by summing over all fingerprints and counting number of partial solutions with these fingerprints as described in the fingerprint gadgets we obtain that the number of Hamiltonian cycles equals the claimed quantity. \square

By the definition of \mathbf{A} from Lemma 4.2, $\mathbf{A} = \mathbf{C}(\mathbf{F}^{\otimes q})^{-1}$ with

$$\mathbf{C}[f, f] = \begin{cases} 1, & \text{if } \eta(f) \models \varphi, \\ 0, & \text{otherwise.} \end{cases}$$

Thus, in matrix terms, (3) can be rewritten into

$$\mathbf{1}^T (\mathbf{F}^{\otimes q})^{-1} \mathbf{F}^{\otimes q} \mathbf{C} (\mathbf{F}^{\otimes q})^{-1} \mathbf{F}^{\otimes q} \mathbf{1} = \mathbf{1}^T \mathbf{C} \mathbf{1},$$

which is easily seen to be the number of assignments of X that satisfy φ modulo p , as required.

Pathwidth bound. Recall the graph G' has pathwidth $q\beta + O(\beta)$. It is easy to see that the additions of the graphs G_i^L and G_i^R do not increase the pathwidth beyond this bound: We can simply introduce and forget each G_i^R separately at the end of the path decomposition. As similar approach can be used for G_i^L in the start of the path decomposition where we each time only forget the top vertex (except t_1). Recall that $q = n/\gamma$. We will now set the parameters β and γ . We first show that we can find the needed sufficiently large sets \mathcal{B}_l and \mathcal{B}_r :

Lemma 4.7. $\text{rk}_p = \lim_{\beta \rightarrow \infty} \frac{1}{\beta} \log_2 \text{rank}_p(\mathbf{M}_\beta)$. $\forall \epsilon', \beta$
 $\mathcal{B}_l, \mathcal{B}_r$ fingerprints $[\beta]$ of size at least $(2 + \text{rk}_p - \epsilon')^\beta$ exist. $\mathbf{H}_\beta[\mathcal{B}_l, \mathcal{B}_r]$ has
 p fingerprints $(d_L, M_L) \in \mathcal{B}_l$ and $(d_R, M_R) \in \mathcal{B}_r$ such that $d_l(1), d_r(1), d_l(2)$ and $d_r(3)$ are
 $1, \{1, 3\} \in M_l$ and $\{1, 2\} \in M_r$.

By Fact 2.2, we have $\text{rank}(\mathbf{H}_\beta) \geq (2 + r_p - \epsilon')^\beta$ for large enough β , and by the same binomial theorem argument from (1) we also have that set of linearly independent rows and columns exist consisting of fingerprints (d, M) satisfying $|d^{-1}(1)| \geq 4$. Then there must be a vertex matched to the same vertices in the row index M_1 and column index M_2 in at least an $1/\beta^2$ fraction of both basis matchings by the pigeon principle. Denoting this vertex and its two frequent neighbors with $1, 2, 3$ the claim follows. \square

Let $\hat{\epsilon} = \epsilon/2$, and pick β sufficiently large such that Lemma 4.7 ensures the sets $\mathcal{B}_l, \mathcal{B}_r$ of fingerprints on $[\beta]$ of size at least $(2 + \text{rk}_p - \hat{\epsilon})^\beta$ exist. To ensure the existence of the injective encoding functions η_1, \dots, η_q , we pick γ such that $2^\gamma < (2 + \text{rk}_p - \hat{\epsilon})^\beta$; set γ as large as possible under this constraint so that $\gamma \geq \beta \log_2(2 + \text{rk}_p - \hat{\epsilon}) - 1$. The pathwidth of G will be at most

$$q\beta + O(\beta) = (n/\gamma)\beta + O(\beta) \leq n/(\log_2(2 + \text{rk}_p - \hat{\epsilon}) - 1/\beta) + O(\beta).$$

The running time of the assumed algorithm for counting the number of Hamiltonian cycles modulo p of the created instance will thus be $O^*(2^{\alpha n + O(\beta)}) = O^*(2^{\alpha n})$ time where

$$\alpha = \frac{(\log_2(2 + \text{rk}_p - \epsilon))}{\log_2(2 + \text{rk}_p - \hat{\epsilon}) - 1/\beta},$$

which is smaller than 1 for sufficiently large β (which may depend on ϵ). Finally, it can be easily checked that the graph G can trivially be constructed in time polynomial in the size of φ and p for constant ϵ . \square

5 Conclusions

As future work, we suggest the problem of counting the connected induced subgraphs of a graph, where one could try to exclude $O^*(2^{o(\text{pw} \log \text{pw})})$ time algorithms. The connection matrix for this problem is the meet matrix of the partition lattice, ordered by refinement, so that the coarsest partition with one block is the smallest element. For this setting, the powerful technology of Möbius functions (see e.g. [27] and recently [10, 33]) can readily give rank lower bounds, but it is not a priori clear how to construct the gadgets required for converting the rank bound into an algorithmic lower bound. Another example could be the problem of counting Steiner Trees, which has an $O^*(5^{\text{pw}})$ time algorithm from [7], or the evaluation of graph polynomials, such as the Tutte polynomial, at fixed points.

A further natural direction for future research is to find the optimal constant c_p such that #HC modulo p can be solved in $O^*(c_p^{\text{pw}})$ time and not in $O^*((c_p - \varepsilon)^{\text{pw}})$ time for $\varepsilon > 0$. It is natural to conjecture that $c_p = 2 + r_p$, where $r_p = \lim_{\beta \rightarrow \infty} \log_2(\text{rk}_p(\mathbf{M}_\beta))/\beta$. However, note that in [11], obtaining an algorithm from the rank upper bound was not trivial and, unlike the lower bound from Theorem 1.3, it is not a priori clear how to use matrix upper bounds as a black box. The main reason is that it is not clear how to reduce the work related to \mathbf{M} to constant-sized copies as done in the proof of Theorem 1.3. Furthermore, to explore this direction, we need better lower bounds for the rank of \mathbf{M}_k over \mathbb{Z}_p , since the bounds from our paper are tight only over \mathbb{Q} .

Acknowledgments Jesper acknowledges Marek Cygan for discussions on Section 4.

References

- [1] Josh Alman and Ryan Williams. Probabilistic rank and matrix rigidity. In *STOC*, STOC 2017, pages 641–652, New York, NY, USA, 2017. ACM.
- [2] Regev Amitai. Identities for the number of standard Young tableaux in some (k, l) -hooks. *SIAM J. Discrete Math.*, 63(3), 2010.
- [3] E. Bannai and T. Ito. *Algebraic Combinatorics*. Mathematics lecture note series. Benjamin/Cummings Pub. Co., 1984.
- [4] Andreas Björklund. Determinant sums for undirected hamiltonicity. *SIAM J. Discrete Math.*, 43(1):280–299, 2014.
- [5] Andreas Björklund and Thore Husfeldt. The parity of directed hamiltonian cycles. In *STOC*, pages 727–735. IEEE Computer Society, 2013.
- [6] Andreas Björklund, Petteri Kaski, and Ioannis Koutis. Directed Hamiltonicity and Out-Branchings via Generalized Laplacians. In *STOC*, 2017. to appear.
- [7] Hans L. Bodlaender, Marek Cygan, Stefan Kratsch, and Jesper Nederlof. Deterministic single exponential time algorithms for connectivity problems parameterized by treewidth. *J. ACM*, 243:86–111, 2015.
- [8] Peter Bürgisser, Michael Clausen, and Mohammad Amin Shokrollahi. *Algebraic Complexity Theory*, volume 315 of *Grundlehren der Mathematischen Wissenschaften*. Springer, 1997.
- [9] Chris Calabro, Russell Impagliazzo, Valentine Kabanets, and Ramamohan Paturi. The complexity of unique k-SAT: An isolation lemma for k-CNFs. *J. ACM*, 74(3):386–393, 2008.
- [10] Radu Curticapean, Holger Dell, and Dániel Marx. Homomorphisms are a good basis for counting small subgraphs. In *STOC*, pages 210–223, 2017.

- [11] Marek Cygan, Stefan Kratsch, and Jesper Nederlof. Fast hamiltonicity checking via bases of perfect matchings. In *STACS 2013*, pages 301–310, 2013.
- [12] Marek Cygan, Jesper Nederlof, Marcin Pilipczuk, Michal Pilipczuk, Johan M. M. van Rooij, and Jakub Onufry Wojtaszczyk. Solving connectivity problems parameterized by treewidth in single exponential time. In Rafail Ostrovsky, editor, *STOC 2011*, pages 150–159. IEEE Computer Society, 2011.
- [13] Fedor V. Fomin, Daniel Lokshtanov, Fahad Panolan, and Saket Saurabh. Efficient computation of representative families with applications in parameterized and exact algorithms. *JACM*, 63(4):29:1–29:60, 2016.
- [14] C. Godsil and K. Meagher. *Random walks on graphs*. Cambridge Studies in Advanced Mathematics. Cambridge University Press, 2015.
- [15] Chris Godsil and Gordon Royle. *Algebraic combinatorics*, volume 207 of *Encyclopedia of Mathematics and its Applications*. Springer-Verlag, New York, 2001.
- [16] Jozef Gruska, editor. *Mathematical foundations of quantum computation*, volume 53 of *Frontiers in Physics*. Springer, 1977.
- [17] Godfrey H. Hardy and Edward M. Wright. *An introduction to the theory of numbers*. Oxford University Press, Oxford, sixth edition, 2008. Revised by D. R. Heath-Brown and J. H. Silverman, With a foreword by Andrew Wiles.
- [18] Russel Impagliazzo and Ramamohan Paturi. On the complexity of k -SAT. *JACM*, 62(2):367–375, 2001.
- [19] Tomer Kotek and Johann A. Makowsky. Connection matrices and the definability of graph parameters. In *STACS 2012*, pages 411–425, 2012.
- [20] Stefan Kratsch and Magnus Wahlström. Compression via matroids: A randomized polynomial kernel for odd cycle transversal. *SIAM J. Comput.*, 10(4):20:1–20:15, 2014.
- [21] Eyal Kushilevitz and Noam Nisan. *Computational complexity*. Cambridge University Press, New York, NY, USA, 1997.
- [22] Nathan Lindzey. Erdős–Ko–Rado for perfect matchings. *SIAM J. Comput.*, 65:130 – 142, 2017.
- [23] Daniel Lokshtanov, Dániel Marx, and Saket Saurabh. Known algorithms on graphs on bounded treewidth are probably optimal. In Dana Randall, editor, *STOC 2011*, pages 777–789. SIAM, 2011.

- [24] László Lovász. The rank of connection matrices and the dimension of graph algebras. *SIAM J. Discrete Math.*, 27(6):962–970, 2006.
- [25] László Lovász. *Combinatorics*, volume 60 of *CBMS Regional Conference Series in Mathematics*. American Mathematical Society, 2012.
- [26] László Lovász and Michael E. Saks. Lattices, Möbius functions and communication complexity. In *Proceedings of the 29th Annual Symposium on Foundations of Computer Science*, pages 81–90. IEEE Computer Society, 1988.
- [27] László Lovász and Michael Saks. Communication complexity and combinatorial lattice theory. *SIAM J. Discrete Math.*, 47(2):322 – 349, 1993.
- [28] I.G. Macdonald. *Symmetric Functions and Hall Algebras*. Oxford mathematical monographs. Clarendon Press, 1995.
- [29] Jiří Matoušek. *Combinatorics*, volume 53. American Mathematical Soc., 2010.
- [30] B. Monien. How to find long paths efficiently. *SIAM J. Discrete Math.*, 109:239 – 254, 1985. Analysis and Design of Algorithms for Combinatorial Problems.
- [31] M. Petkovsek, H.S. Wilf, and D. Zeilberger. *AB*. A K Peters Series. Taylor & Francis, 1996.
- [32] Ran Raz and Boris Spieker. On the "log rank"-conjecture in communication complexity. *SIAM J. Discrete Math.*, 15(4):567–588, 1995.
- [33] Marc Roth. Counting restricted homomorphisms via Möbius inversion over matroid lattices. *arXiv preprint abs/1706.08414*, 2017.
- [34] B. Sagan. *Combinatorics*. Graduate Texts in Mathematics. Springer New York, 2001.
- [35] Ed Scheinerman. Matgraph toolbox. <https://www.mathworks.com/matlabcentral/fileexchange/19218-matgraph>.
- [36] R.P. Stanley. *Enumerative Combinatorics*, volume 2 of *Enumerative Combinatorics*. Cambridge University Press, 2001.
- [37] R. M. Thrall. On symmetrized Kronecker powers and the structure of the free Lie ring. *SIAM J. Discrete Math.*, 64(1):pp. 371–388, 1942.
- [38] Richard Ryan Williams. The polynomial method in circuit complexity applied to algorithm design (invited talk). In Venkatesh Raman and S. P. Suresh, editors, *Proceedings of the 45th Annual ACM Symposium on Theory of Computing*, volume 29 of *SIAM J. Discrete Math.*, pages 47–60. Schloss Dagstuhl - Leibniz-Zentrum fuer Informatik, 2014.
- [39] Michal Włodarczyk. Clifford algebras meet tree decompositions. In Jiong Guo and Danny Hermelin, editors, *Proceedings of the 48th Annual ACM Symposium on Theory of Computing*, volume 63 of *SIAM J. Discrete Math.*, pages 29:1–29:18. Schloss Dagstuhl - Leibniz-Zentrum fuer Informatik, 2016.

A Proof of Theorem 1.1 from Theorem 1.2 and Theorem 1.3

We'll prove a slightly stronger consequence, namely that there is an algorithm that in $O^*((2-\varepsilon)^n)$ time counts the number of satisfying assignments of a given a CNF-formula on n variables, for some $\varepsilon > 0$.

Let n be the number of variables of the given CNF-formula φ . The Chinese Remainder Theorem (CRT) tells us that given the number of satisfying assignments of φ modulo primes p_1, \dots, p_ℓ , we can compute the number of satisfying solutions of φ as long as $\prod_{i=1}^\ell p_i \geq 2^n$. By the Prime Number Theorem [17, p. 494, Eq. (22.19.3)], there are at least $r/\log_2 r$ primes between r and $2r$, and thus

$$\prod_{r \leq p \text{ prime} \leq 2r} p \geq r^{r/\log_2 r} \geq 2^{\Omega(r)}.$$

It follows that for counting the number of satisfying assignments of a given CNF-formula, it is sufficient to count the number of satisfying assignments modulo p for any $p = \Theta(n)$. We do this using Lemma 4.1 combined with the algorithm for #HC. For fixed t we have that $\text{rank}_p(\mathbf{M}_t) = \text{rank}(\mathbf{M}_t)$ for large enough p (which can for example be shown by upper bounding the determinant of \mathbf{M}_t by $t!$). The assumed algorithm for #HC also counts the number of Hamiltonian cycles modulo p . By Theorem 1.3 we have $\lim_{p \rightarrow \infty} r_p = 4$ and Theorem 1.1 follows.

B Finite Group Representation Theory

For any set X , let $\mathbb{C}[X]$ denote the vector space of dimension $|X|$ of complex-valued functions X . A \mathfrak{g} (ϕ, V) of a finite group G is a homomorphism $\phi : G \rightarrow \text{GL}(V)$ where $\text{GL}(V)$ is the group of $\dim V \times \dim V$ invertible matrices. We refer to the representation (ϕ, V) simply as ϕ when V is understood, or as V when ϕ is understood. For any representation ϕ , we define its \mathfrak{h} to be $\dim \phi := \dim V$. Two representations ρ, ϕ are \mathfrak{h} if $\rho(g)$ and $\phi(g)$ are similar for all $g \in G$.

Let (ϕ, V) be a representation of a finite group G , and let $W \leq V$ be a \mathfrak{h} subspace, that is, $\phi(g)w \in W$ for all $w \in W$ and for all $g \in G$. We say that $(\phi|_W, W)$ is a \mathfrak{h} of ϕ where $\phi|_W$ is the restriction of ϕ to the subspace W . A representation (ϕ, V) is an \mathfrak{h} (or simply, an \mathfrak{h}) if it has no proper sub-representations.

It is well-known that there is a one-to-one correspondence between the set of inequivalent irreducibles of G and its conjugacy classes \mathcal{C} , and that any representation V of G uniquely decomposes as a finite direct sum of inequivalent irreducibles V_i of G :

$$V \cong \bigoplus_{i=1}^{|\mathcal{C}|} m_i V_i$$

where m_i is the \mathfrak{h} of V_i (the number of times that V_i occurs in the decomposition). Natural representations of groups can be obtained by letting them act on sets. In particular, for any group G acting on a set X , let $(\phi, \mathbb{C}[X])$ be the \mathfrak{h} of G on X defined such that

$$\phi(g)[f(x)] = f(g^{-1}x)$$

for all $g \in G$, $f \in \mathbb{C}[X]$, and $x \in X$. If we let G act on itself ($X = G$), then we obtain the ~~h~~
~~h~~, which admits the following decomposition into irreducibles:

$$\mathbb{C}[G] \cong \bigoplus_{i=1}^{|\mathcal{C}|} (\dim \phi_i)^2 V_i$$

where (ϕ_i, V_i) is the i th irreducible of G . Letting $e_g e_h = e_{gh}$ over the standard basis $\{e_g\}_{g \in G}$ of $\mathbb{C}[G]$, we see that $\mathbb{C}[G]$ is an algebra, the so-called ~~h~~ of G .

For any (irreducible) representation ϕ of G , the ~~h~~ χ_ϕ of ϕ is the map $\chi_\phi : G \rightarrow \mathbb{C}$ such that $\chi_\phi(g) := \text{Tr}(\phi(g))$. Similar matrices have the same trace, thus the character of a representation is a ~~h~~, that is, they are constant on conjugacy classes. Furthermore, the characters of the set of all irreducible representations of a group G form an orthonormal basis for the space of all class functions of $\mathbb{C}[G]$.

C A simple rank lower bound

To obtain the lower bound of $\Omega(1.568^k)$ on the rank of \mathbf{M}_k in Theorem 1.3, we proceed in two steps: First, we explicitly compute the rank of a matchings connectivity matrix of small constant order B , then we amplify the rank of this small matrix to larger orders by a product construction. As it turns out, choosing $B = 10$ suffices to ultimately improve upon $\Theta(\sqrt{2}^n)$.

C.1 The initial matrix

In the following, fix a prime number $p \neq 2$. For the first step, we chose $B = 10$ and explicitly compute the matchings connectivity matrix M_{10} with a computer program, as explained in Section C.3. From the 945×945 matrix \mathbf{M}_{10} , we then select a particular sub-matrix \mathbf{M}^* as follows:

1. Keep only those rows corresponding to perfect matchings of K_{10} that contain the edge $\{1, 2\}$. This amounts to 105 of the 945 original rows. We require $\{1, 2\}$ to be contained in the selected perfect matchings to enable the product construction later on, where we will “cut open” Hamiltonian cycles between vertices 1 and 2 and patch the resulting Hamiltonian paths together.
2. Among the resulting 105×945 matrix, identify a square matrix of dimensions $D \times D$ that has full rank over \mathbb{Z}_p . We wish to choose D as large as possible, and using a computer program, we observe that one can choose $D \geq 90$ for every prime $p \neq 2$.

The construction of \mathbf{M}^* from \mathbf{M}_{10} is summarized in the following lemma, and its computational proof is deferred to Section C.3.

Lemma C.1. ~~h~~ $p \neq 2$, ~~h~~ $I_R, I_C \subseteq \mathcal{M}_{10}$
~~h~~ $|I_R| = |I_C| = 90$ ~~h~~ $\{1, 2\} \in N$ ~~h~~ $N \in I_R$ ~~h~~ $\mathbf{M}^* = \mathbf{M}_{10}[I_R, I_C]$
~~h~~ \mathbb{Z}_p .

C.2 Amplification via Kronecker products

In the remainder of this section, consider $p \neq 2$ to be a fixed prime. Furthermore, assume we are given a fixed number $B \in \mathbb{N}$ and fixed sets of perfect matchings $I_R, I_C \subseteq \mathcal{M}_B$ such that $\{1, 2\} \in N$

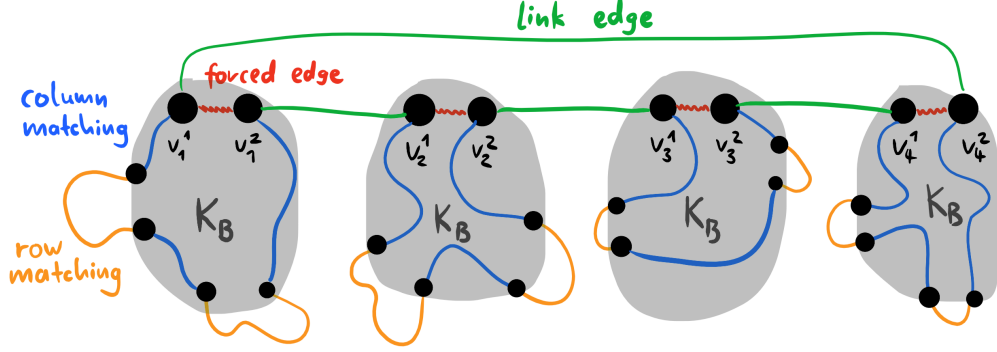

Fig. 6: The graph $K_B^{(t)}$ for $B = 6$ and $t = 4$. A row matching (from I_R) and a column matching (from I_C) is shown at each copy of K_B . In each copy $i \in [t]$, the row matching is forced to contain the edge between v_i^1 and v_i^2 . If we take the union of all row and column matchings, then delete the forced edges and add all link edges, we obtain a Hamiltonian cycle of $K_B^{(t)}$.

for all perfect matchings $N \in I_R$ and $\mathbf{M}^* = \mathbf{M}_B[I_R, I_C]$ has full rank over \mathbb{Z}_p . Lemma C.1 shows that, for $B = 10$, we can obtain $I_R, I_C \subseteq \mathcal{M}_{10}$ with $|I_R| = |I_C| = 90$.

We design a product construction that will allow us to “tensor up” this fixed matrix \mathbf{M}^* of relatively large rank, thus obtaining rank lower bounds for \mathbf{M}_{tB} for $t \in \mathbb{N}$. Write $D = |I_R| = |I_C|$. For $t \in \mathbb{N}$, we prove the rank lower bound on \mathbf{M}_{tB} by exhibiting a sub-matrix with dimensions $D^t \times D^t$ that has full rank over \mathbb{Z}_p . This can be rephrased as $\text{rank}(\mathbf{M}_n) \geq \Omega(D^{n/B})$, and for our particular parameters, we obtain $\text{rank}(\mathbf{M}_n) \geq \Omega(90^{n/10}) = \Omega(1.568^n)$.

To proceed, we define a particular graph $K_B^{(t)}$ on tB vertices for each $t \in \mathbb{N}$. For our lower bound, it will suffice to consider only perfect matchings contained in $K_B^{(t)}$, even if these represent only a vanishing fraction of the perfect matchings in K_{tB} .

Definition C.2. For $B, t \in \mathbb{N}$, let $K_B^{(t)}$ be the graph

$$\begin{aligned}
 & \text{with } t \text{ copies of } K_B. \\
 & \text{The vertex set is } \{v_i^1, \dots, v_i^B \mid i \in [t]\} \\
 & \text{with edges } \{v_i^2 \text{ to } v_{i+1}^1 \mid i \in [t-1]\} \\
 & \text{and link edges.}
 \end{aligned}$$

Let us write $\mathcal{M}[G]$ for the perfect matchings of a graph G . We observe that $\mathcal{M}[K_B^{(t)}]$ contains the “ t -th power” of $\mathcal{M}[K_B]$, that is, all perfect matchings of $K_B^{(t)}$ that can be obtained by taking disjoint t copies of the perfect matchings in K_B , one for each $i \in [t]$. This powering operation is formalized in the following definition.

Definition C.3. Let $t \in \mathbb{N}$. For $\bar{N} = (N_1, \dots, N_t) \in (\mathcal{M}_B)^t$, let $\mathfrak{J}_{\text{disj}}(\bar{N})$ be the set of perfect matchings of $K_B^{(t)}$ defined by $\mathfrak{J}_{\text{disj}}(\bar{N}) = \{\{v_i^a, v_i^b\} \mid i \in [t] \text{ and } \{a, b\} \in N_i\}$.

The construction of $K_B^{(t)}$ implies that $\mathfrak{J}_{\text{disj}}(\bar{N})$ is a perfect matching of $K_B^{(t)}$ for each $\bar{N} \in (\mathcal{M}_B)^t$. We now consider the perfect matchings of K_{10} that are contained in I_C and define the “ t -th power of I_C ” under the operation $\mathfrak{J}_{\text{disj}}(\cdot)$ as the set

$$I_C^{\otimes t} = \{\mathfrak{J}_{\text{disj}}(\bar{N}) \mid \bar{N} \in (I_C)^t\}.$$

A similar set $I_R^{\otimes t}$ will be defined to represent the “ t -th power of I_R ”, but for this power, we will slightly modify the operation $\mathfrak{J}_{\text{disj}}(\cdot)$ into an operation $\mathfrak{J}_{\text{link}}(\cdot)$ that additionally incorporates the link edges of $K_B^{(t)}$ into the perfect matching: Given a tuple $\overline{N} = (N_1, \dots, N_t) \in (I_R)^t$, we will sacrifice the edge $\{1, 2\} \in N_i$ for each $i \in [t]$, which is present in N_i by definition of I_R , and patch the link edges of $K_B^{(t)}$ into the resulting isolated vertices.

Definition C.4. $\overline{N} = (N_1, \dots, N_t) \in (I_R)^t$, $\mathfrak{J}_{\text{link}}(\overline{N})$

$$K_B^{(t)} \text{ is } \mathfrak{J}_{\text{disj}}(\overline{N}).$$

$$\text{for } i \in [t], \{v_i^1, v_i^2\} \in N_i \text{ and } v_i^1, v_i^2 \in [t].$$

$$K_B^{(t)} \text{ is } \mathfrak{J}_{\text{link}}(\overline{N}) \text{ for } i \in [t] \text{ and } 0 \leq v_i^1, v_i^2 \leq 1.$$

We observe that $\mathfrak{J}_{\text{link}}(\overline{N})$ is properly defined only for $\overline{N} \in (I_R)^t$. Furthermore, it follows from the construction that $\mathfrak{J}_{\text{link}}(\overline{N})$ is a perfect matching of $K_B^{(t)}$ for every $\overline{N} \in (I_R)^t$. We then define the “ t -th power of I_R ” under the operation $\mathfrak{J}_{\text{link}}(\cdot)$ as

$$I_R^{\otimes t} = \{\mathfrak{J}_{\text{link}}(\overline{N}) \mid \overline{N} \in (I_R)^t\}.$$

It is easily observed that $|I_R^{\otimes t}| = |I_C^{\otimes t}| = D^t$, as the perfect matchings in $I_R^{\otimes t}$ correspond bijectively to the tuples in $(I_R)^t$, and likewise for $I_C^{\otimes t}$ and $(I_C)^t$. The matchings connectivity matrix M_{tB} takes a particular form when restricted to rows from $I_R^{\otimes t}$ and columns from $I_C^{\otimes t}$.

Lemma C.5. $A^{\otimes t} \text{ is } t\text{-H} \text{ and } A.$

$$M_{tB}[I_R^{\otimes t}, I_C^{\otimes t}] = (M^*)^{\otimes t}. \quad (4)$$

Let $N_R \in I_R^{\otimes t}$ and $N_C \in I_C^{\otimes t}$. Then we have

$$N_R = \mathfrak{J}_{\text{link}}(\overline{N}_R) \text{ for a unique } \overline{N}_R = (N_{R,1}, \dots, N_{R,t}) \in (I_R)^t, \text{ and}$$

$$N_C = \mathfrak{J}_{\text{disj}}(\overline{N}_C) \text{ for a unique } \overline{N}_C = (N_{C,1}, \dots, N_{C,t}) \in (I_C)^t.$$

We first show that the union $N_R \cup N_C$ forms a Hamiltonian cycle of K_{tB} iff, for each $i \in [t]$, the union $N_{R,i} \cup N_{C,i}$ forms a Hamiltonian cycle in K_B :

- Assume that, for every $i \in [t]$, the set $Z_i = N_{R,i} \cup N_{C,i}$ is a Hamiltonian cycle in K_B . By definition of $I_R^{\otimes t}$, we have $\{1, 2\} \in N_{R,i}$ for every $i \in [t]$, and hence deleting this edge turns Z_i into a Hamiltonian path from 1 to 2 in K_B . Taking these t Hamiltonian paths and adding the link edges of $K_B^{(t)}$ yields a Hamiltonian cycle in $K_B^{(t)}$, and hence, in K_{tB} . This implies that $N_R \cup N_C = \mathfrak{J}_{\text{link}}(\overline{N}_R) \cup \mathfrak{J}_{\text{disj}}(\overline{N}_C)$ is a Hamiltonian cycle in K_{tB} .
- Conversely, assume that $Z = N_R \cup N_C$ is a Hamiltonian cycle in K_{tB} . Then, since $Z \in I_R^{\otimes t} \cup I_C^{\otimes t}$, it is a Hamiltonian cycle in $K_B^{(t)}$. We observe that Z uses all link edges of $K_B^{(t)}$, since $N_R \in I_R^{\otimes t}$ and was thus obtained by an application of $\mathfrak{J}_{\text{link}}(\cdot)$. This implies that, for every $i \in [t]$, the subset Z_i of Z induced by the vertices $V_i = \{v_i^1, \dots, v_i^2\}$ is a Hamiltonian

path of $K_B^{(t)}[V_i]$ that runs between vertices v_i^1 and v_i^2 . Adding the edge $\{v_i^1, v_i^2\}$ that was deleted in the application of $\mathfrak{J}_{\text{link}}(\cdot)$ turns Z_i into a Hamiltonian cycle of $K_B^{(t)}[V_i]$ containing the edge $\{v_i^1, v_i^2\}$.

This implies that $\mathbf{M}_{tB}[N_R, N_C] = 1$ iff $\mathbf{M}_B[N_{R,i}, N_{C,i}] = 1$ for all $i \in [t]$, so we conclude that

$$\mathbf{M}_{tB}[N_R, N_C] = \prod_{i=1}^t \mathbf{M}_B[N_{R,i}, N_{C,i}],$$

from which (4) readily follows. \square

A simple property of Kronecker products is that, for matrices A and B that have full rank (over a field), the product $A \otimes B$ also has full rank. This readily implies the following corollary.

Corollary C.6. ~~For~~ $\mathbf{M}_{tB}[I_R^{\otimes t}, I_C^{\otimes t}]$ ~~is~~ \mathbb{Z}_p ~~invertible~~ D^t .

In conclusion, by using the constant-sized initial matrix \mathbf{M}^* found by the computer search, we obtain the following lower bound on the rank of M_n :

Theorem C.7. ~~For~~ $p \neq 2$, ~~the~~ \mathbf{M}_n ~~is~~ $\Omega(90^{n/10}) = \Omega(1.568^n)$.

The basis of the exponent can be improved by using larger initial matrices M^* , which can be derived from \mathbf{M}_B for $B > 10$. We chose $B = 10$, since this is the smallest $B \in \mathbb{N}$ for which the resulting lower bound on the rank of \mathbf{M}_n over \mathbb{Z}_p with $p \neq 2$ is higher than over \mathbb{Z}_2 . We are currently also preparing a more refined patching procedure that yields better lower bounds with essentially the same proof outline.

C.3 Computational proof of Lemma C.1

To prove Lemma C.1, we provide the following in the ancillary files:

1. A pair $I_R^{(1)}, I_C^{(1)} \subseteq \mathcal{M}_{10}$ with $|I_R^{(1)}| = |I_C^{(1)}| = 90$ such that the determinant of $\mathbf{M}_{10}[I_R^{(1)}, I_C^{(1)}]$ contains only the prime factors 2 and 37.
2. A pair $I_R^{(2)}, I_C^{(2)} \subseteq \mathcal{M}_{10}$ with $|I_R^{(2)}| = |I_C^{(2)}| = 90$ such that the determinant of $\mathbf{M}_{10}[I_R^{(2)}, I_C^{(2)}]$ contains only the prime factors 2 and 3.

If $p \notin \{3, 37\}$, we can use either of the two pairs as I_R, I_C . If $p = 3$, we use the first pair. If $p = 37$, we use the second pair. It should be noted that our pairs satisfy $I_C^{(1)} = I_C^{(2)}$.

We include a MATLAB script (`Main.m`) that contains the pairs $(I_R^{(1)}, I_C^{(1)})$ and $(I_R^{(2)}, I_C^{(2)})$. The code also checks that the two conditions outlined above indeed hold for these pairs. This uses a subroutine `testrank(IR, IC)` that obtains as input a list `IR` of row matchings and a list `IC` of column matchings, all of which are perfect matchings of K_{10} . The routine computes the submatrix of \mathbf{M}_{10} induced by these matchings, then it computes the determinant of this submatrix and outputs the unique prime factors of this number. In its current version, our script requires the subroutines `partition`, `parts`, and `join` from the `ML` package [35] that allow us to instantiate partitions, extract their blocks, and compute the join of two partitions in the partition lattice.