

Symmetric functions and wavefunctions of the six-vertex model by Izergin-Korepin analysis

Kohei Motegi *

*Faculty of Marine Technology, Tokyo University of Marine Science and Technology,
Etchujima 2-1-6, Koto-Ku, Tokyo, 135-8533, Japan*

April 30, 2019

Abstract

We analyze wavefunctions of the six-vertex model by extending the Izergin-Korepin analysis on the domain wall boundary partition functions. We particularly focus on the case with triangular boundary. By using the $U_q(sl_2)$ R -matrix and a special class of the triangular K -matrix, we first introduce an analogue of the wavefunctions of the integrable six-vertex model with triangular boundary. We first give a characterization of the wavefunctions by extending our recent work of the Izergin-Korepin analysis of the domain wall boundary partition function with triangular boundary, and then determine the explicit form of the symmetric functions representing the wavefunctions by showing that it satisfies all the required properties. We also illustrate the Izergin-Korepin analysis for the case of ordinary wavefunctions as it is the basic case.

1 Introduction

The most fundamental and important objects in statistical physics are partition functions. Exact computations of partition functions have great impacts in mathematical physics and mathematics. The field of integrable lattice models [1, 2, 3, 4] offers us chances to compute partition functions exactly, and have stimulated the advances of representation theory and algebraic combinatorics. One of the most basic partition functions called the domain wall boundary partition function [5, 6] has become famous in the field of algebraic combinatorics in 1990s, since its determinant form was realized to be a certain generalization of the generating function of the enumeration of the alternating sign matrix [7, 8, 9, 10]. Relation with classical integrable models [11], orthogonal polynomials [12], asymptotics in the thermodynamic limit [13, 14, 15] were also investigated.

Various variations of the domain wall boundary partition functions were introduced. One of the motivations of studying these variations comes from the expectation that investigating

*E-mail: kmoteg0@kaiyodai.ac.jp

variations leads us to applications to the variations of the enumeration of the alternating sign matrices [9, 10, 16, 17, 18].

In recent years, more generic partition functions which we shall call as the wavefunctions are attracting attention. The domain wall boundary partition function can be regarded as the simplest case of the wavefunctions. By studying the wavefunctions of various integrable models and various boundary conditions, it has been recognized that their explicit forms are nothing but symmetric functions such as the Schur, Hall-Littlewood, Grothendieck polynomials and their deformations. As one of the applications of these integrable model realizations of symmetric polynomials, we can discover various new algebraic combinatorial identities which give substantial generalizations of the Cauchy, dual Cauchy, Littlewood, Tokuyama formulae and the Littlewood-Richardson coefficients. There are now a lot of papers on this subject. See [19, 20, 21, 22, 23, 24, 25, 26, 27, 28, 29, 30, 31, 32] for examples which investigate symmetric functions by using the XXZ model and the q -boson model, and [33, 34, 35, 36, 37, 38] by using the free-fermion model in an external field .

In this paper, we introduce and study an analogue of the wavefunctions. We investigate the wavefunctions with triangular boundary. The main motivation of introducing this object is to generalize combinatorial objects such as the non-intersecting lattice paths and excited Young diagrams in Schubert calculus [39, 40, 41, 42, 43]. By translating those combinatorial objects into the language of integrable lattice models, one finds that those combinatorial objects use the $q = 0$ degeneration of the $U_q(sl_2)$ R -matrix as bulk weights. From the point of view of quantum integrability, it is natural to have the following feeling: why don't we use the $U_q(sl_2)$ R -matrix itself as bulk weights? In our very recent work [44], we analyzed the domain wall boundary partition function with triangular boundary which is the very first step, and determined its explicit expression as a certain symmetric function. The Izergin-Korepin analysis [5, 6, 48] was crucial to get the explicit form. In this paper, we extend the Izergin-Korepin analysis to the wavefunctions, and determine the explicit form which is an extension of the symmetric function representing the domain wall boundary partition function.

This paper is organized as follows. In the next section, we first list the $U_q(sl_2)$ R -matrix and the triangular K -matrix which we use in this paper. Using these R -matrix and K -matrix, we introduce the wavefunctions with triangular boundary in section 3. In section 4, we make the Izergin-Korepin analysis and list the properties needed to determine the explicit form of the wavefunctions. In section 5, we present the symmetric function which gives the explicit form of the wavefunctions by showing that it satisfies all the required properties. Section 6 is devoted to conclusion. We illustrate the Izergin-Korepin analysis to the ordinary wavefunctions in the Appendix.

2 The six-vertex model

In this section, we introduce the $U_q(sl_2)$ R -matrix and the K -matrix which will be used as local bulk and boundary pieces of the wavefunctions with triangular boundary which will be introduced in the next section.

The most fundamental objects in integrable lattice models are the R -matrix. In this

paper, we use the following $U_q(sl_2)$ R -matrix [45, 46]

$$R_{ab}(u, w) = \begin{pmatrix} u - tw & 0 & 0 & 0 \\ 0 & t(u - w) & (1 - t)u & 0 \\ 0 & (1 - t)w & u - w & 0 \\ 0 & 0 & 0 & u - tw \end{pmatrix}, \quad (2.1)$$

acting on the tensor product $W_a \otimes W_b$ of the complex two-dimensional space W_a . Let us denote the orthonormal basis of W_a and its dual as $\{|0\rangle_a, |1\rangle_a\}$ and $\langle 0|_a, \langle 1|_a\rangle$, and the matrix elements of the R -matrix as ${}_a\langle\gamma|_b\langle\delta|R_{ab}(u, w)|\alpha\rangle_a|\beta\rangle_b = [R_{ab}(u, w)]_{\alpha\beta}^{\gamma\delta}$. The matrix elements of the R -matrix are explicitly given as

$${}_a\langle 0|_b\langle 0|R_{ab}(u, w)|0\rangle_a|0\rangle_b = u - tw, \quad (2.2)$$

$${}_a\langle 0|_b\langle 1|R_{ab}(u, w)|0\rangle_a|1\rangle_b = t(u - w), \quad (2.3)$$

$${}_a\langle 0|_b\langle 1|R_{ab}(u, w)|1\rangle_a|0\rangle_b = (1 - t)u, \quad (2.4)$$

$${}_a\langle 1|_b\langle 0|R_{ab}(u, w)|0\rangle_a|1\rangle_b = (1 - t)w, \quad (2.5)$$

$${}_a\langle 1|_b\langle 0|R_{ab}(u, w)|1\rangle_a|0\rangle_b = u - w, \quad (2.6)$$

$${}_a\langle 1|_b\langle 1|R_{ab}(u, w)|1\rangle_a|1\rangle_b = u - tw. \quad (2.7)$$

The R -matrix (2.1) satisfies the Yang-Baxter relation

$$R_{ab}(u, v)R_{ac}(u, w)R_{bc}(v, w) = R_{bc}(v, w)R_{ac}(u, w)R_{ab}(u, v), \quad (2.8)$$

acting on $W_a \otimes W_b \otimes W_c$.

See Figures 1 and 2 for the graphical description of the R -matrix and the Yang-Baxter relation used in this paper. The R -matrices have origins in statistical physics, and $|0\rangle$ or its dual $\langle 0|$ can be regarded as a spin up state, while $|1\rangle$ or its dual $\langle 1|$ can be interpreted as a spin down state from the point of view of statistical physics. We sometimes use the terms spin up states (up spins) and spin down states (down spins) to describe states constructed from $|0\rangle$, $\langle 0|$, $|1\rangle$ and $\langle 1|$ since they are convenient for the description of the states.

We also introduce the triangular K -matrix acting on W_a (see Figure 3)

$$K_a(u) = \begin{pmatrix} Bu - A & 0 \\ u - u^{-1} & Bu^{-1} - A \end{pmatrix}, \quad (2.9)$$

where A and B are arbitrary complex parameters. The matrix elements are explicitly given by

$${}_a\langle 0|K_a(u)|0\rangle_a = Bu - A, \quad (2.10)$$

$${}_a\langle 0|K_a(u)|1\rangle_a = 0, \quad (2.11)$$

$${}_a\langle 1|K_a(u)|1\rangle_a = Bu^{-1} - A, \quad (2.12)$$

$${}_a\langle 1|K_a(u)|0\rangle_a = u - u^{-1}. \quad (2.13)$$

The K -matrix (2.9) together with the R -matrix satisfy the following relation

$$R_{ba}(u/w)K_b(u)R_{ab}(uw)K_a(w) = K_a(w)R_{ba}(uw)K_b(u)R_{ab}(u/w), \quad (2.14)$$

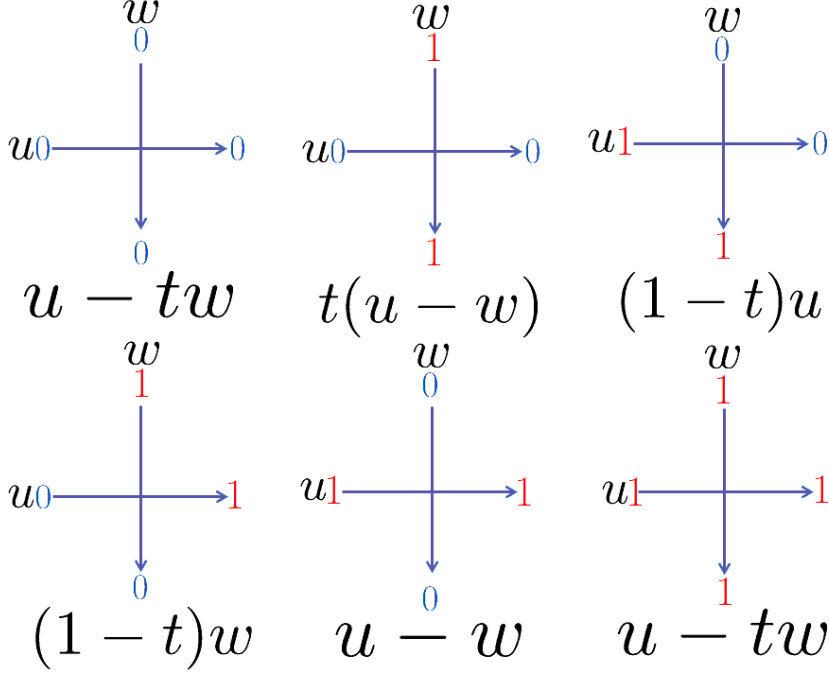

Figure 1: The R -matrix $R(u, w)$ (2.1). We regard that each line is a representation space and carries a spectral parameter. In this picture, the horizontal line carries a spectral parameter u , while the vertical line carries w .

which is called as the reflection equation or the boundary Yang-Baxter equation [47]. The reflection equation ensures the integrability at the boundary, and we use this particular K -matrix as local pieces of the wavefunctions at the boundary. Note that (2.9) can be regarded as a specialization of the full K -matrix which satisfies the reflection equation (2.14). See Figure 4 for the graphical representation of the reflection equation.

For later convenience, we finally define in this section the following Pauli spin operators σ^+ and σ^- as operators acting on the (dual) orthonormal basis as

$$\sigma^+|1\rangle = |0\rangle, \quad \sigma^+|0\rangle = 0, \quad \langle 0|\sigma^+ = \langle 1|, \quad \langle 1|\sigma^+ = 0, \quad (2.15)$$

$$\sigma^-|0\rangle = |1\rangle, \quad \sigma^-|1\rangle = 0, \quad \langle 1|\sigma^- = \langle 0|, \quad \langle 0|\sigma^- = 0. \quad (2.16)$$

3 Wavefunctions

To introduce the wavefunctions with triangular boundary, we introduce the tensor product of the Fock spaces $W_{-n} \otimes \cdots \otimes W_{-1} \otimes W_1 \otimes \cdots \otimes W_N$. Note that here we do not introduce a Fock space named W_0 .

We next define the following monodromy matrix $T_j(u_1, \dots, u_j | w_1, \dots, w_N)$, $j = 1, \dots, n$ using the R -matrix and the K -matrix as

$$\begin{aligned} & T_j(u_1, \dots, u_j | w_1, \dots, w_N) \\ &= R_{-j, N}(u_j, w_N) \cdots R_{-j, 1}(u_j, w_1) R_{-j, -1}(u_j u_1, 1) \cdots R_{-j, -j+1}(u_j u_{j-1}, 1) K_{-j}(u_j), \end{aligned} \quad (3.1)$$

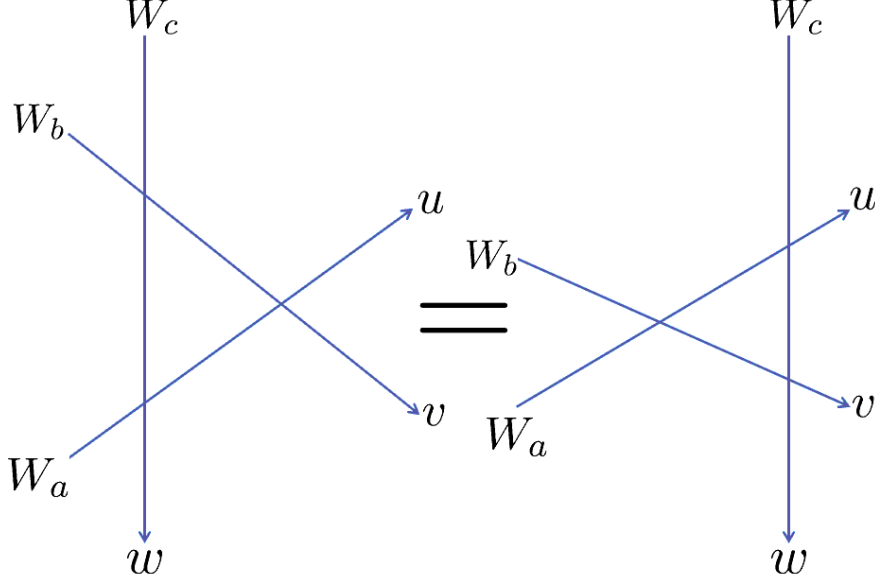

Figure 2: The Yang-Baxter relation (2.8). The left and right figure represents $R_{ab}(u, v)R_{ac}(u, w)R_{bc}(v, w)$ and $R_{bc}(v, w)R_{ac}(u, w)R_{ab}(u, v)$ respectively.

which acts on $W_{-j} \otimes \cdots \otimes W_{-1} \otimes W_1 \otimes \cdots \otimes W_N$. See Figure 5 for a pictorial description of (3.1).

Next, we define the state vector $|\Psi_{N,n}(u_1, \dots, u_n | w_1, \dots, w_N)\rangle \in W_1 \otimes \cdots \otimes W_N$ by using the monodromy matrix $T_j(u_1, \dots, u_j | w_1, \dots, w_N)$ as

$$|\Psi_{N,n}(u_1, \dots, u_n | w_1, \dots, w_N)\rangle = \langle 0^n | T_1(u_1 | w_1, \dots, w_N) \cdots T_n(u_n | w_1, \dots, w_N) | \Omega \rangle_{n+N}, \quad (3.2)$$

where the states $\langle 0^n |$ and $|\Omega\rangle_{n+N}$ are defined as

$$\langle 0^n | = {}_{-n}\langle 0 | \otimes \cdots \otimes {}_{-1}\langle 0 |, \quad (3.3)$$

$$|\Omega\rangle_{n+N} = |0\rangle_{-n} \otimes \cdots \otimes |0\rangle_{-1} \otimes |0\rangle_1 \otimes \cdots \otimes |0\rangle_N. \quad (3.4)$$

This is an analogue of the off-shell Bethe vector. We remark that there is a big difference on the properties between the state vector (3.2) and the ordinary off-shell Bethe vector. The ordinary off-shell Bethe vector of the six-vertex model (and its degeneration to the five-vertex model) is constructed from the multiple action of the so-called B -operators on the vacuum state, and one B -operator always creates one down spin, hence the ordinary off-shell Bethe vector constructed from n layers of B -operators gives an n -down spin state. However, the state vector (3.2) constructed from n layers $T_j(u_1, \dots, u_j | w_1, \dots, w_N)$, $j = 1, \dots, n$ do not always give an n -down spin state.

Keeping this in mind, let us now introduce an analogue of the wavefunctions with trian-

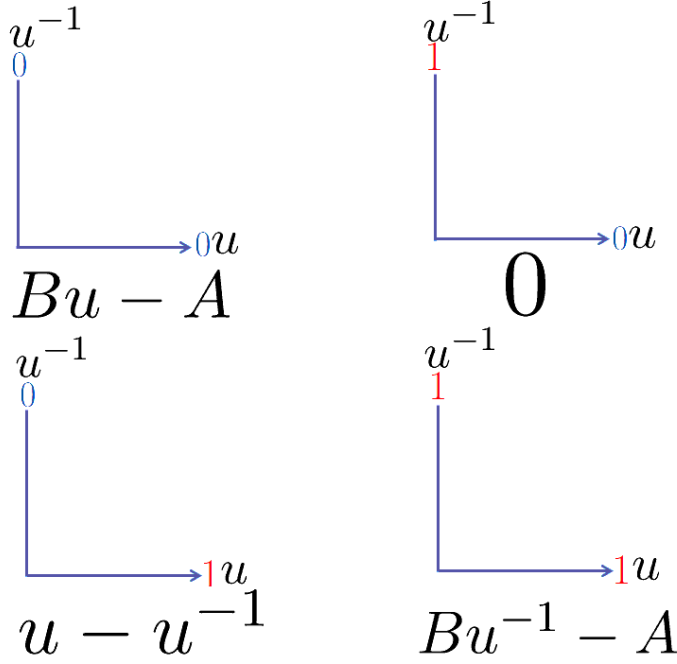

Figure 3: The K -matrix $K(u)$ (2.9). We regard that the horizontal line carries a spectral parameter u , while the vertical line carries its inverse u^{-1} .

gular boundary. We first introduce the following dual spin states

$$\langle x_1 \cdots x_m | = ({}_1\langle 0 | \otimes \cdots \otimes {}_N\langle 0 |) \prod_{j=1}^m \sigma_{x_j}^+ \in W_1^* \otimes \cdots \otimes W_N^*, \quad (3.5)$$

which are states labelling the configurations of down spins $1 \leq x_1 < x_2 < \cdots < x_m \leq N$. W_a^* means the dual space of W_a .

Now we define the wavefunctions with triangular boundary $W_{N,n,m}(u_1, \dots, u_n | w_1, \dots, w_n | x_1, \dots, x_m)$ as the inner product between the state vector $|\Psi_{N,n}(u_1, \dots, u_n | w_1, \dots, w_n)\rangle$ and the m -down spin state $\langle x_1 \cdots x_m |$ as

$$W_{N,n,m}(u_1, \dots, u_n | w_1, \dots, w_n | x_1, \dots, x_m) = \langle x_1 \cdots x_m | \Psi_{N,n}(u_1, \dots, u_n | w_1, \dots, w_n)\rangle. \quad (3.6)$$

The wavefunctions (3.6) can be seen as an extension of the domain wall boundary partition function with triangular boundary

$$Z_{n,m}(u_1, \dots, u_n | w_1, \dots, w_m) = \langle 0^n 1^m | T_1(u_1 | w_1, \dots, w_m) \cdots T_n(u_1, \dots, u_n | w_1, \dots, w_m) | \Omega \rangle_{n+m}, \quad (3.7)$$

$$\langle 0^n 1^m | = {}_{-n}\langle 0 | \otimes \cdots \otimes {}_{-1}\langle 0 | \otimes {}_1\langle 1 | \otimes \cdots \otimes {}_m\langle 1 |, \quad (3.8)$$

which we introduced in our last paper [44], since the special case $N = m$, $x_j = j$, $j = 1, \dots, m$ of the wavefunctions (3.6) is nothing but the domain wall boundary partition function

$$W_{m,n,m}(u_1, \dots, u_n | w_1, \dots, w_m | 1, \dots, m) = Z_{n,m}(u_1, \dots, u_n | w_1, \dots, w_m). \quad (3.9)$$

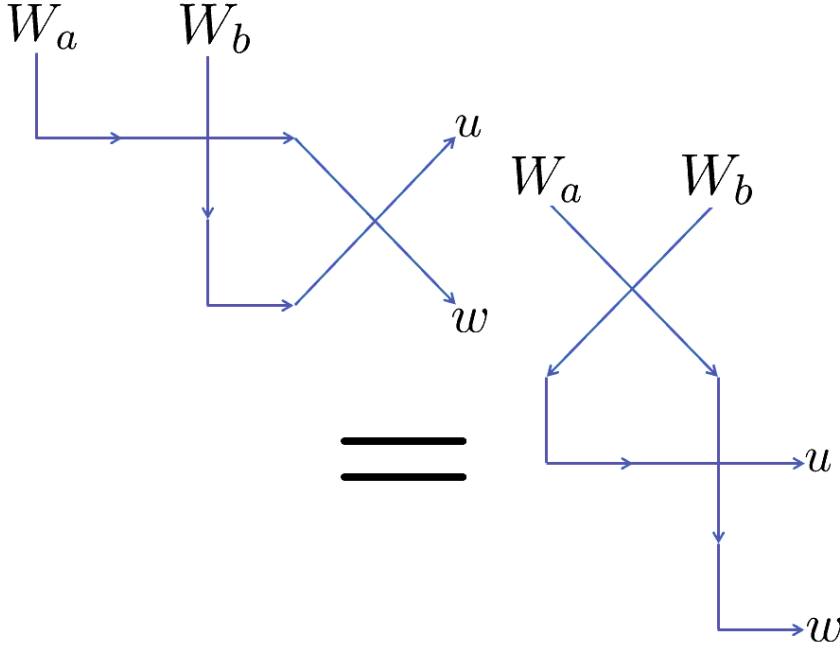

Figure 4: The reflection equation (2.14). The left and right figure represents $R_{ba}(u/w)K_b(u)R_{ab}(uw)K_a(w)$ and $K_a(w)R_{ba}(uw)K_b(u)R_{ab}(u/w)$ respectively.

The wavefunctions $W_{N,n,m}(u_1, \dots, u_n | w_1, \dots, w_N | x_1, \dots, x_m)$ is a symmetric function with respect to the spectral parameters $\{u\}_n$ which can be shown in the same way we showed for the case of the domain wall boundary partition function [44] by the so-called railroad argument using the Yang-Baxter relation and the reflection equation. Thus, we sometimes abbreviate $W_{N,n,m}(u_1, \dots, u_n | w_1, \dots, w_N | x_1, \dots, x_m)$ as

$W_{N,n,m}(\{u\}_n | w_1, \dots, w_N | x_1, \dots, x_m)$ where $\{u\}_n$ means $\{u_1, \dots, u_n\}$ as a set. See Figure 6 for the graphical description of the wavefunctions $W_{N,n,m}(u_1, \dots, u_n | w_1, \dots, w_N | x_1, \dots, x_m)$.

4 Izergin-Korepin analysis

In this section, we list and prove the properties of the wavefunctions

$W_{N,n,m}(u_1, \dots, u_n | w_1, \dots, w_N | x_1, \dots, x_m)$ defined in the last section by extending the Izergin-Korepin analysis [5, 6, 48] on the domain wall boundary partition function with triangular boundary in our recent paper [44].

Proposition 4.1. *The wavefunctions $W_{N,n,m}(u_1, \dots, u_n | w_1, \dots, w_N | x_1, \dots, x_m)$ satisfies the following properties.*

- (1) $W_{N,n,m}(u_1, \dots, u_n | w_1, \dots, w_N | x_1, \dots, x_m)$ is a polynomial of degree $n-1$ in w_N if $x_m = N$ and degree n if $x_m \neq N$.
- (2) $W_{N,n,m}(u_1, \dots, u_n | w_1, \dots, w_N | x_1, \dots, x_m)$ is symmetric with respect to u_j , $j = 1, \dots, n$.

$$T_j(u_1, \dots, u_j | w_1, \dots, w_N)$$

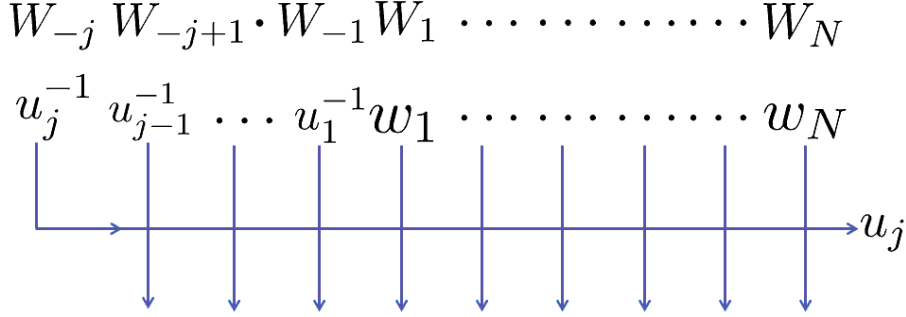

Figure 5: The monodromy matrix $T_j(u_1, \dots, u_j | w_1, \dots, w_N)$ (3.1).

(3) The following recursive relations between the wavefunctions hold if $x_m = N$ (Figure 7):

$$\begin{aligned} & W_{N,n,m}(u_1, \dots, u_n | w_1, \dots, w_N | x_1, \dots, x_m) |_{w_N = t^{-1}u_n} \\ &= (1-t) \prod_{j=1}^{n-1} (tu_j - u_n) \prod_{j=1}^n (u_j u_n - 1) \prod_{j=1}^{N-1} (u_n - w_j) \\ & \quad \times W_{N-1,n-1,m-1}(u_1, \dots, u_{n-1} | w_1, \dots, w_{N-1} | x_1, \dots, x_{m-1}). \end{aligned} \quad (4.1)$$

If $x_m \neq N$, the following factorizations hold for the wavefunctions (Figure 8):

$$\begin{aligned} & W_{N,n,m}(u_1, \dots, u_n | w_1, \dots, w_N | x_1, \dots, x_m) \\ &= \prod_{j=1}^n (u_j - tw_N) W_{N-1,n,m}(u_1, \dots, u_n | w_1, \dots, w_{N-1} | x_1, \dots, x_m). \end{aligned} \quad (4.2)$$

(4) The following explicit evaluations hold for the case $N = m = 1$ (Figure 9):

$$\begin{aligned} & W_{1,n,1}(u_1, \dots, u_n | w | 1) |_{w = t^{-1}u_n} \\ &= (1-t) \prod_{j=1}^{n-1} (tu_j - u_n) (Bu_j - A) \prod_{j=1}^n (u_j u_n - 1) \prod_{1 \leq j < k \leq n-1} (u_j u_k - t). \end{aligned} \quad (4.3)$$

If $N = 1$, $m = 0$, the following explicit evaluation holds (Figure 10):

$$W_{1,n,0}(u_1, \dots, u_n | w) = \prod_{j=1}^n (Bu_j - A) \prod_{j=1}^n (u_j - tw) \prod_{1 \leq j < k \leq n} (u_j u_k - t). \quad (4.4)$$

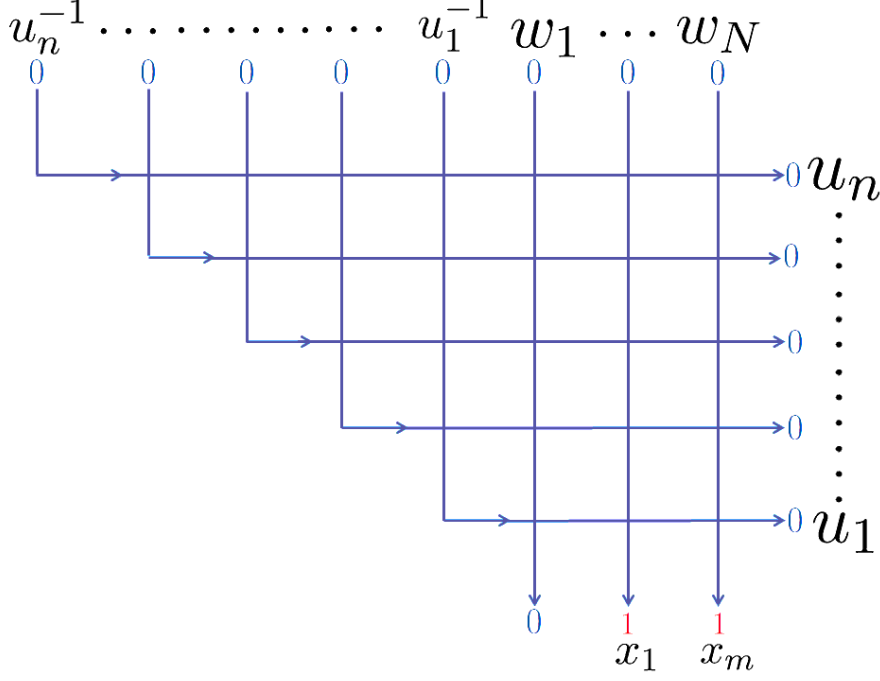

Figure 6: The wavefunctions with triangular boundary $W_{N,n,m}(u_1, \dots, u_n | w_1, \dots, w_N | x_1, \dots, x_m)$ (3.7). This figure illustrates the case $N = 3$, $n = 5$, $m = 2$, $x_1 = 2$, $x_2 = 3$.

Proof. Property (1) for the case $x_m = N$ can be easily shown in the same way with the domain wall boundary partition function (with triangular boundary) by inserting the completeness relation in one spin down state sector.

For the case $x_m \neq N$, one can also easily show by its graphical representation and the ice rule of the R -matrix ${}_a \langle \gamma | {}_b \langle \delta | R_{ab}(u, w) | \alpha \rangle_a | \beta \rangle_b = 0$ unless $\alpha + \beta = \gamma + \delta$. Using the ice rule, one finds that the R -matrices on the rightmost row freeze (Figure 8). The contribution to the weights from the frozen rightmost row is $\prod_{j=1}^n (u_j - tw_N)$, and the remaining part is nothing but the wavefunctions $W_{N-1,n,m}(u_1, \dots, u_n | w_1, \dots, w_{N-1} | x_1, \dots, x_m)$. This shows that $W_{N,n,m}(u_1, \dots, u_n | w_1, \dots, w_N | x_1, \dots, x_m)$ has the following factorization for the case $x_m \neq N$

$$\begin{aligned} & W_{N,n,m}(u_1, \dots, u_n | w_1, \dots, w_N | x_1, \dots, x_m) \\ &= \prod_{j=1}^n (u_j - tw_N) W_{N-1,n,m}(u_1, \dots, u_n | w_1, \dots, w_{N-1} | x_1, \dots, x_m), \end{aligned} \quad (4.5)$$

which is nothing but (4.2). This relation shows Properties (1) and (3) for the case $x_m \neq N$.

Property (2) can be shown by the standard railroad argument using the Yang-Baxter relation and the reflection equation repeatedly, exactly in the same way we proved for the case of the domain wall boundary partition function [44]. We remark that the wavefunctions $W_{N,n,m}(u_1, \dots, u_n | w_1, \dots, w_N | x_1, \dots, x_m)$ is no more symmetric with respect to w_j , $j = 1, \dots, m$ in general unlike the domain wall boundary partition function. This comes from the fact that the dual spin state $\langle x_1 \cdots x_m |$ which is used to construct the wavefunctions is

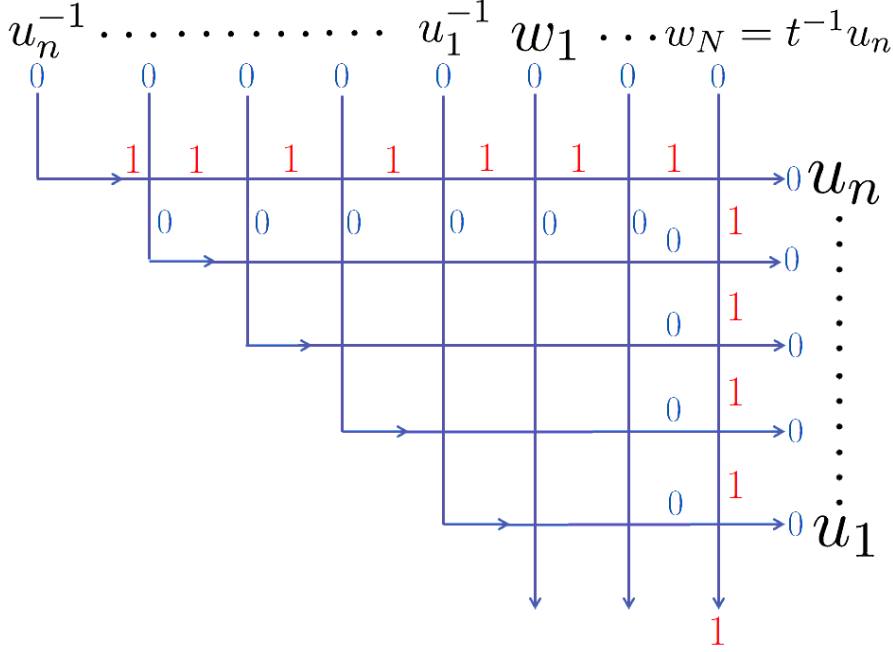

Figure 7: The recursion relation $W_{N,n,m}(u_1, \dots, u_n | w_1, \dots, w_N | x_1, \dots, x_m)$, $x_m = N$ evaluated at $w_N = t^{-1}u_n$ (4.1) .

not a consecutive sequence of down spins anymore in general. Note that the dual spin state $\langle x_1 \cdots x_m |$ does not have any influence on the railroad argument to prove the commutativity of the spectral parameters $\{u\}_n$.

Property (3) for the case $x_m = N$ can be proved with the help of the graphical representation of the wavefunctions $W_{N,n,m}(u_1, \dots, u_n | w_1, \dots, w_N | x_1, \dots, x_m)$, and can be showed essentially in the same way with proving a similiar property for the domain wall boundary partition function $Z_{n,m}(\{u\}_n | \{w\}_m)$ [44]. To show (4.1), let us see what happens when one sets w_N as $w_N = t^{-1}u_n$ (see Figure 7). One first sees that the R -matrix at the top right corner freezes due to the vanishing property ${}_{-n}\langle 0 | {}_N \langle 0 | R(u_n, w_N = t^{-1}u_n) | 0 \rangle_{-n} | 0 \rangle_N = 0$. Then using the ice rule of the R -matrix, one finds the top row and the rightmost column freeze. The total contribution of the weights from the freezeed part can be calculated by multiplying all the matrix elements of the R -matrix and the K -matrix which appear, and we find it is given by $(1-t) \prod_{j=1}^{n-1} (tu_j - u_n) \prod_{j=1}^n (u_j u_n - 1) \prod_{j=1}^{N-1} (u_n - w_j)$. Next, one finds that the remaining unfreezeed part is nothing but the wavefunctions $W_{N-1,n-1,m-1}(u_1, \dots, u_{n-1} | w_1, \dots, w_{N-1} | x_1, \dots, x_{m-1})$, from which one concludes that $W_{N,n,m}(u_1, \dots, u_n | w_1, \dots, w_N | x_1, \dots, x_m)$ evaluated at $w_N = t^{-1}u_n$ is the product of $(1-t) \prod_{j=1}^{n-1} (tu_j - u_n) \prod_{j=1}^n (u_j u_n - 1) \prod_{j=1}^{N-1} (u_n - w_j)$ and $W_{N-1,n-1,m-1}(u_1, \dots, u_{n-1} | w_1, \dots, w_{N-1} | x_1, \dots, x_{m-1})$. This shows (4.1).

What remains to be shown is Property (4), which can be regarded as the initial condition of the recursion relation (Property (3)).

Property (4) for the case $m = 1$ is shown in [44]. We include the proof here for the sake of completeness. This can be shown in the same way as Property (3). Let us denote w_1 as w for simplicity. From its graphical representation, one finds great simplification occurs

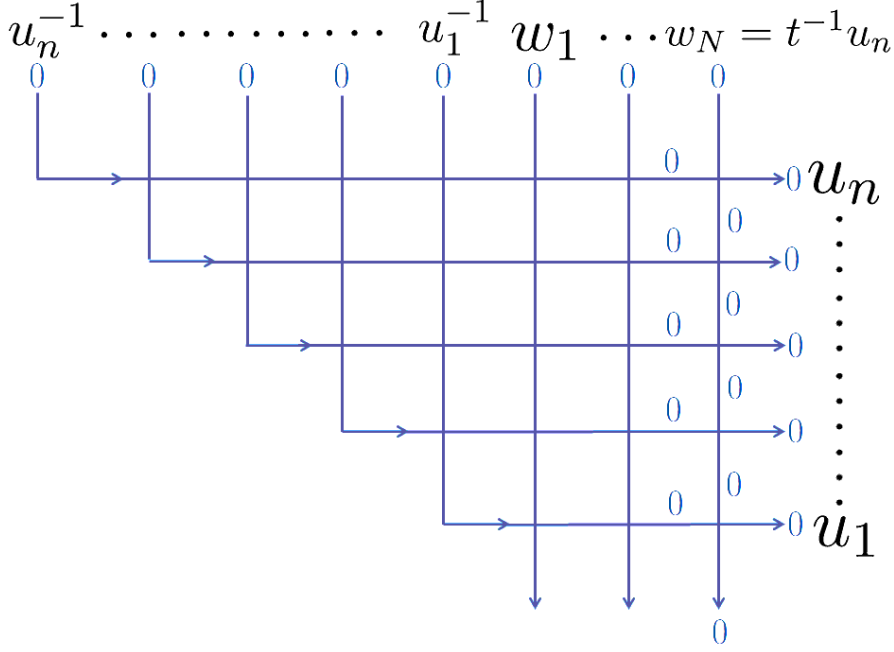

Figure 8: The factorization of $W_{N,n,m}(u_1, \dots, u_n | w_1, \dots, w_N | x_1, \dots, x_m)$, $x_m \neq N$ (4.2) .

for the wavefunction $W_{1,n,1}(u_1, \dots, u_n | w | 1)$ (Figure 9). When one sets $w = t^{-1}u_n$, one first finds that the top row and the rightmost column freeze. We make a further observation on $W_{1,n,1}(u_1, \dots, u_n | w | 1)$. Using the property ${}_a\langle 0 | K_a(u) | 1 \rangle_a = 0$ of the triangular K -matrix (2.9), one finds that all spins on the bottom row freeze, and this freezing process continues and we finally find that all spins get frozen. Multiplying all the appearing matrix elements of the R -matrix and the K -matrix, one finds the total contribution is given by $(1-t) \prod_{j=1}^{n-1} (tu_j - u_n) (Bu_j - A) \prod_{j=1}^n (u_j u_n - 1) \prod_{1 \leq j < k \leq n-1} (u_j u_k - t)$, hence (4.3) is shown.

Property (4) for the case $m = 0$ can also be proved in the same way. By drawing the graphical representation of $W_{1,n,0}(u_1, \dots, u_n | w)$, one finds by using the ice rule of the R -matrix and the property ${}_a\langle 0 | K_a(u) | 1 \rangle_a = 0$ of the K -matrix that all spins get frozen. Multiplying all the appearing matrix elements of the R -matrix and the K -matrix, one finds the total contribution to the wavefunctions is given by $\prod_{j=1}^n (Bu_j - A) \prod_{j=1}^n (u_j - tw) \prod_{1 \leq j < k \leq n} (u_j u_k - t)$, from which one concludes (4.4) holds. See Figure 10 for the graphical representation of $W_{1,n,0}(u_1, \dots, u_n | w)$. □

5 Symmetric functions

In this section, we introduce a class of symmetric function, and prove that the symmetric function represents the wavefunctions of the six-vertex model with triangular boundary $W_{N,n,m}(u_1, \dots, u_n | w_1, \dots, w_N | x_1, \dots, x_m)$ by showing that it satisfies all the required properties derived by the Izergin-Korepin analysis in the last section.

Definition 5.1. We define the following symmetric function

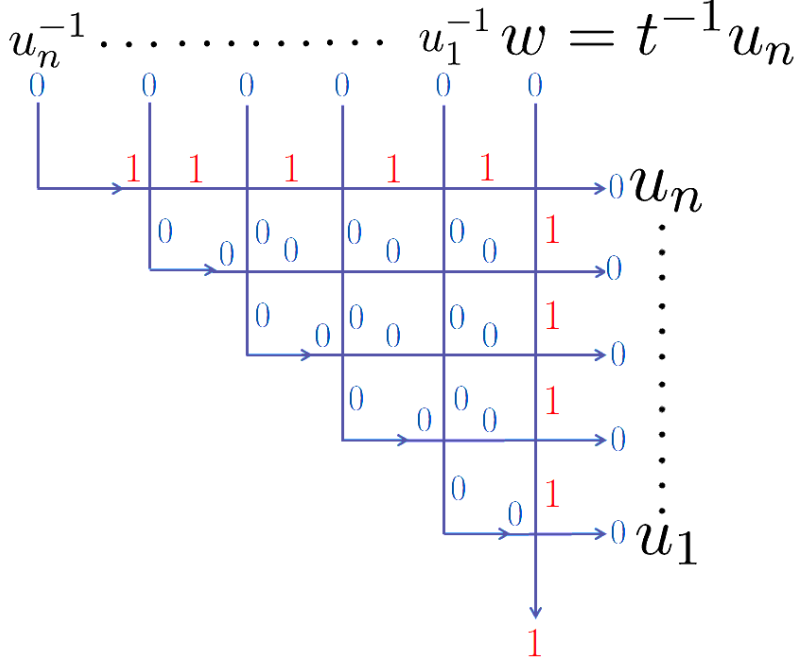

Figure 9: The recursion relation $W_{N,n,m}(u_1, \dots, u_n | w_1, \dots, w_N | x_1, \dots, x_m)$ evaluated at $w = t^{-1}u_n$ for the case $N = m = 1, x_1 = 1$ (4.3).

$F_{N,n,m}(u_1, \dots, u_n | w_1, \dots, w_N | x_1, \dots, x_m)$ which depends on the symmetric variables u_1, \dots, u_n , complex parameters w_1, \dots, w_N and integers x_1, \dots, x_m satisfying $1 \leq x_1 < \dots < x_m \leq N$,

$$\begin{aligned}
& F_{N,n,m}(u_1, \dots, u_n | w_1, \dots, w_N | x_1, \dots, x_m) \\
&= \frac{1}{(n-m)!} \sum_{\sigma \in S_n} \prod_{j=1}^m \prod_{k=x_j+1}^N (u_{\sigma(j)} - tw_k) \prod_{1 \leq j < k \leq m} \frac{tu_{\sigma(j)} - u_{\sigma(k)}}{u_{\sigma(j)} - u_{\sigma(k)}} (u_{\sigma(j)}u_{\sigma(k)} - 1) \\
&\quad \times \prod_{\substack{m+1 \leq j \leq n \\ 1 \leq k \leq N}} (u_{\sigma(j)} - tw_k) \prod_{\substack{m+1 \leq j \leq n \\ 1 \leq k \leq m}} \frac{tu_{\sigma(j)} - u_{\sigma(k)}}{u_{\sigma(j)} - u_{\sigma(k)}} (u_{\sigma(j)}u_{\sigma(k)} - 1) \\
&\quad \times \prod_{j=1}^m \prod_{k=1}^{x_j-1} (u_{\sigma(j)} - w_k) \prod_{m+1 \leq j < k \leq n} (u_{\sigma(j)}u_{\sigma(k)} - t) \\
&\quad \times \prod_{j=1}^m (1-t)(u_{\sigma(j)}^2 - 1) \prod_{j=m+1}^n (Bu_{\sigma(j)} - A). \tag{5.1}
\end{aligned}$$

Theorem 5.2. *The wavefunctions of the six-vertex model with triangular boundary $Z_{N,n,m}(u_1, \dots, u_n | w_1, \dots, w_N | x_1, \dots, x_m)$ is explicitly expressed as the symmetric function $F_{N,n,m}(u_1, \dots, u_n | w_1, \dots, w_N | x_1, \dots, x_m)$*

$$Z_{N,n,m}(u_1, \dots, u_n | w_1, \dots, w_N | x_1, \dots, x_m) = F_{N,n,m}(u_1, \dots, u_n | w_1, \dots, w_N | x_1, \dots, x_m). \tag{5.2}$$

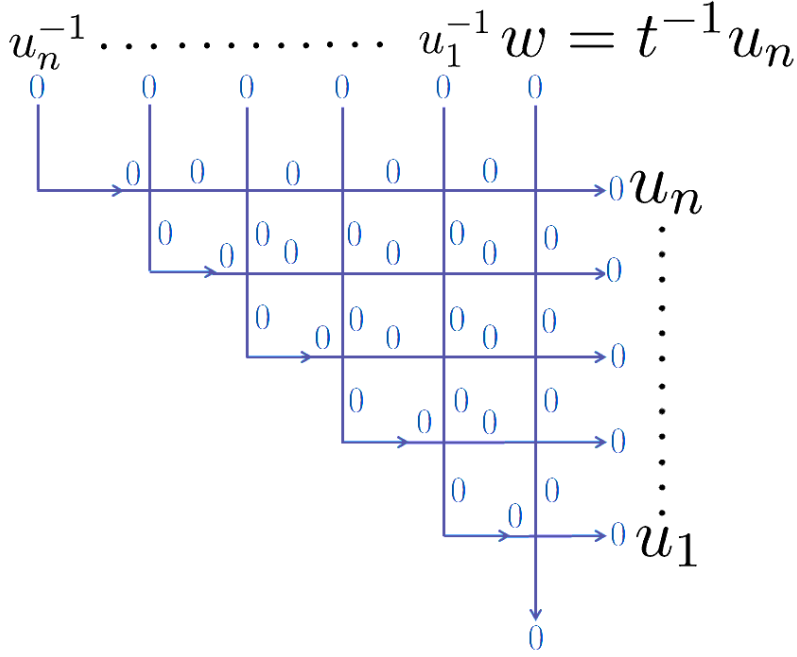

Figure 10: The factorization of $W_{N,n,m}(u_1, \dots, u_n | w_1, \dots, w_N | x_1, \dots, x_m)$ for the case $N = 1$, $m = 0$ (4.4).

Proof. We prove this theorem by showing that the symmetric function (5.1) $F_{N,n,m}(u_1, \dots, u_n | w_1, \dots, w_N | x_1, \dots, x_m)$ satisfies all the four Properties in Proposition 4.1.

Let us first show Property (1). First, note that the factor $\prod_{j=1}^m \prod_{k=x_j+1}^N (u_{\sigma(j)} - tw_k)$ in $F_{N,n,m}(u_1, \dots, u_n | w_1, \dots, w_N | x_1, \dots, x_m)$ is a polynomial of degree $m - 1$ in w_N if $x_m = N$ and degree m if $x_m \neq N$. There is also a factor $\prod_{m+1 \leq j \leq n} (u_{\sigma(j)} - tw_N)$ in (5.1) which contributes to the degree of w_N , and one finds that $F_{N,n,m}(u_1, \dots, u_n | w_1, \dots, w_N | x_1, \dots, x_m)$ is a polynomial of degree $n - 1$ in w_N if $x_m = N$ and degree n if $x_m \neq N$.

It is also easy to find that $F_{N,n,m}(u_1, \dots, u_n | w_1, \dots, w_N | x_1, \dots, x_m)$ is symmetric with respect to u_j , $j = 1, \dots, n$, since the sum is over all permutations of the variables u_j , $j = 1, \dots, n$.

Let us show Property (3). We first show the function $F_{N,n,m}(\{u\}_n | w_1, \dots, w_N | x_1, \dots, x_m)$ satisfies (4.1) which we have to prove for the case $x_m = N$. In this case, first note that the factor

$$\prod_{j=1}^m \prod_{k=x_j+1}^N (u_{\sigma(j)} - tw_k) \prod_{\substack{m+1 \leq j \leq n \\ 1 \leq k \leq N}} (u_{\sigma(j)} - tw_k), \quad (5.3)$$

in each summand essentially becomes

$$\prod_{j=1}^{m-1} \prod_{k=x_j+1}^N (u_{\sigma(j)} - tw_k) \prod_{\substack{m+1 \leq j \leq n \\ 1 \leq k \leq N}} (u_{\sigma(j)} - tw_k). \quad (5.4)$$

Then one can extract a factor $\prod_{j=1}^{m-1} (u_{\sigma(j)} - tw_N) \prod_{j=m+1}^N (u_{\sigma(j)} - tw_N)$ from (5.4). Let us concentrate on this factor. If one substitutes $w_N = t^{-1}u_n$, this factor vanishes unless σ satisfies $\sigma(m) = n$.

Therefore, only the summands satisfying $\sigma(m) = n$ in (5.1) survive after the substitution $w_N = t^{-1}u_n$. Keeping this in mind, one rewrites $F_{N,n,m}(\{u\}_n | w_1, \dots, w_N | x_1, \dots, x_m) |_{w_N=t^{-1}u_n}$ by using the symmetric group S_{n-1} where every $\sigma' \in S_{n-1}$ satisfies $\{\sigma'(1), \dots, \sigma'(m-1), \sigma'(m+1), \dots, \sigma'(n)\} = \{1, \dots, n-1\}$ as follows:

$$\begin{aligned} & F_{N,n,m}(u_1, \dots, u_n | w_1, \dots, w_N | x_1, \dots, x_m) |_{w_N=t^{-1}u_n} \\ &= \frac{1}{(n-m)!} \sum_{\sigma' \in S_{n-1}} \prod_{j=1}^{m-1} \prod_{k=x_j+1}^{N-1} (u_{\sigma'(j)} - tw_k) \prod_{1 \leq j < k \leq m-1} \frac{tu_{\sigma'(j)} - u_{\sigma'(k)}}{u_{\sigma'(j)} - u_{\sigma'(k)}} (u_{\sigma'(j)} u_{\sigma'(k)} - 1) \\ & \times \prod_{\substack{m+1 \leq j \leq n \\ 1 \leq k \leq N-1}} (u_{\sigma'(j)} - tw_k) \prod_{\substack{m+1 \leq j \leq n \\ 1 \leq k \leq m-1}} \frac{tu_{\sigma'(j)} - u_{\sigma'(k)}}{u_{\sigma'(j)} - u_{\sigma'(k)}} (u_{\sigma'(j)} u_{\sigma'(k)} - 1) \\ & \times \prod_{j=1}^{m-1} (tu_{\sigma'(j)} - u_n)(u_{\sigma'(j)} u_n - 1) \prod_{j=m+1}^n (tu_{\sigma'(j)} - u_n)(u_{\sigma'(j)} u_n - 1) \\ & \times \prod_{j=1}^{m-1} \prod_{k=1}^{x_j-1} (u_{\sigma'(j)} - w_k) \prod_{k=1}^{N-1} (u_n - w_k) \prod_{m+1 \leq j < k \leq n} (u_{\sigma'(j)} u_{\sigma'(k)} - t) \\ & \times (1-t)(u_n^2 - 1) \prod_{j=1}^{m-1} (1-t)(u_{\sigma'(j)}^2 - 1) \prod_{j=m+1}^n (Bu_{\sigma'(j)} - A). \end{aligned} \quad (5.5)$$

One easily notes that the factors $\prod_{k=1}^{N-1} (u_n - w_k)$ and $(1-t)(u_n^2 - 1)$ in the sum are independent of

the permutation S'_{n-1} . One also finds the factor $\prod_{j=1}^{m-1} (tu_{\sigma'(j)} - u_n)(u_{\sigma'(j)} u_n - 1) \prod_{j=m+1}^n (tu_{\sigma'(j)} - u_n)(u_{\sigma'(j)} u_n - 1)$ is also independent of S'_{n-1} since we have

$$\begin{aligned} & \prod_{j=1}^{m-1} (tu_{\sigma'(j)} - u_n)(u_{\sigma'(j)} u_n - 1) \prod_{j=m+1}^n (tu_{\sigma'(j)} - u_n)(u_{\sigma'(j)} u_n - 1) \\ &= \prod_{j=1}^{n-1} (tu_j - u_n)(u_j u_n - 1). \end{aligned} \quad (5.6)$$

Thus, (5.5) can be rewritten furthermore as

$$\begin{aligned}
& F_{N,n,m}(u_1, \dots, u_n | w_1, \dots, w_N | x_1, \dots, x_m) |_{w_N=t^{-1}u_n} \\
&= (1-t)(u_n^2-1) \prod_{j=1}^{n-1} (tu_j - u_n)(u_j u_n - 1) \prod_{k=1}^{N-1} (u_n - w_k) \\
&\quad \times \frac{1}{(n-m)!} \sum_{\sigma' \in S_{n-1}} \prod_{j=1}^{m-1} \prod_{k=x_j+1}^{N-1} (u_{\sigma'(j)} - tw_k) \prod_{1 \leq j < k \leq m-1} \frac{tu_{\sigma'(j)} - u_{\sigma'(k)}}{u_{\sigma'(j)} - u_{\sigma'(k)}} (u_{\sigma'(j)} u_{\sigma'(k)} - 1) \\
&\quad \times \prod_{\substack{m+1 \leq j \leq n \\ 1 \leq k \leq N-1}} (u_{\sigma'(j)} - tw_k) \prod_{\substack{m+1 \leq j \leq n \\ 1 \leq k \leq m-1}} \frac{tu_{\sigma'(j)} - u_{\sigma'(k)}}{u_{\sigma'(j)} - u_{\sigma'(k)}} (u_{\sigma'(j)} u_{\sigma'(k)} - 1) \\
&\quad \times \prod_{j=1}^{m-1} \prod_{k=1}^{x_j-1} (u_{\sigma'(j)} - w_k) \prod_{m+1 \leq j < k \leq n} (u_{\sigma'(j)} u_{\sigma'(k)} - t) \\
&\quad \times \prod_{j=1}^{m-1} (1-t)(u_{\sigma'(j)}^2 - 1) \prod_{j=m+1}^n (Bu_{\sigma'(j)} - A). \tag{5.7}
\end{aligned}$$

Noting

$$\begin{aligned}
& \frac{1}{(n-m)!} \sum_{\sigma' \in S_{n-1}} \prod_{j=1}^{m-1} \prod_{k=x_j+1}^{N-1} (u_{\sigma'(j)} - tw_k) \prod_{1 \leq j < k \leq m-1} \frac{tu_{\sigma'(j)} - u_{\sigma'(k)}}{u_{\sigma'(j)} - u_{\sigma'(k)}} (u_{\sigma'(j)} u_{\sigma'(k)} - 1) \\
&\quad \times \prod_{\substack{m+1 \leq j \leq n \\ 1 \leq k \leq N-1}} (u_{\sigma'(j)} - tw_k) \prod_{\substack{m+1 \leq j \leq n \\ 1 \leq k \leq m-1}} \frac{tu_{\sigma'(j)} - u_{\sigma'(k)}}{u_{\sigma'(j)} - u_{\sigma'(k)}} (u_{\sigma'(j)} u_{\sigma'(k)} - 1) \\
&\quad \times \prod_{j=1}^{m-1} \prod_{k=1}^{x_j-1} (u_{\sigma'(j)} - w_k) \prod_{m+1 \leq j < k \leq n} (u_{\sigma'(j)} u_{\sigma'(k)} - t) \\
&\quad \times \prod_{j=1}^{m-1} (1-t)(u_{\sigma'(j)}^2 - 1) \prod_{j=m+1}^n (Bu_{\sigma'(j)} - A) \\
&= F_{N-1,n-1,m-1}(u_1, \dots, u_{n-1} | w_1, \dots, w_{N-1} | x_1, \dots, x_{m-1}), \tag{5.8}
\end{aligned}$$

one finds that (5.7) is nothing but the following recursion relation for the symmetric function $F_{N,n,m}(u_1, \dots, u_n | w_1, \dots, w_N | x_1, \dots, x_m)$

$$\begin{aligned}
& F_{N,n,m}(u_1, \dots, u_n | w_1, \dots, w_N | x_1, \dots, x_m) |_{w_N=t^{-1}u_n} \\
&= (1-t) \prod_{j=1}^{n-1} (tu_j - u_n) \prod_{j=1}^n (u_j u_n - 1) \prod_{j=1}^{N-1} (u_n - w_j) \\
&\quad \times F_{N-1,n-1,m-1}(u_1, \dots, u_{n-1} | w_1, \dots, w_{N-1} | x_1, \dots, x_{m-1}), \tag{5.9}
\end{aligned}$$

which is exactly the same recursion relation the wavefunctions

$W_{N,n,m}(u_1, \dots, u_n | w_1, \dots, w_N | x_1, \dots, x_m)$ must satisfy. Hence, Property (3) for the case $x_m = N$ is proved.

The case $x_m \neq N$ can be shown in a similar but much simpler way. In this case we can rewrite $F_{N,n,m}(u_1, \dots, u_n | w_1, \dots, w_N | x_1, \dots, x_m)$ as

$$\begin{aligned}
& F_{N,n,m}(u_1, \dots, u_n | w_1, \dots, w_N | x_1, \dots, x_m) \\
&= \frac{1}{(n-m)!} \sum_{\sigma \in S_n} \prod_{j=1}^m \prod_{k=x_j+1}^{N-1} (u_{\sigma(j)} - tw_k) \prod_{j=1}^m (u_{\sigma(j)} - tw_N) \prod_{1 \leq j < k \leq m} \frac{tu_{\sigma(j)} - u_{\sigma(k)}}{u_{\sigma(j)} - u_{\sigma(k)}} (u_{\sigma(j)} u_{\sigma(k)} - 1) \\
&\quad \times \prod_{\substack{m+1 \leq j \leq n \\ 1 \leq k \leq N-1}} (u_{\sigma(j)} - tw_k) \prod_{j=m+1}^n (u_{\sigma(j)} - tw_N) \prod_{\substack{m+1 \leq j \leq n \\ 1 \leq k \leq m}} \frac{tu_{\sigma(j)} - u_{\sigma(k)}}{u_{\sigma(j)} - u_{\sigma(k)}} (u_{\sigma(j)} u_{\sigma(k)} - 1) \\
&\quad \times \prod_{j=1}^m \prod_{k=1}^{x_j-1} (u_{\sigma(j)} - w_k) \prod_{m+1 \leq j < k \leq n} (u_{\sigma(j)} u_{\sigma(k)} - t) \\
&\quad \times \prod_{j=1}^m (1-t)(u_{\sigma(j)}^2 - 1) \prod_{j=m+1}^n (Bu_{\sigma(j)} - A). \tag{5.10}
\end{aligned}$$

The product of the factors $\prod_{j=1}^m (u_{\sigma(j)} - tw_N)$ and $\prod_{j=m+1}^n (u_{\sigma(j)} - tw_N)$ becomes

$$\prod_{j=1}^m (u_{\sigma(j)} - tw_N) \prod_{j=m+1}^n (u_{\sigma(j)} - tw_N) = \prod_{j=1}^n (u_j - tw_N), \tag{5.11}$$

which becomes independent of the permutation S_n . Taking this into account, (5.10) can be rewritten as

$$\begin{aligned}
& F_{N,n,m}(u_1, \dots, u_n | w_1, \dots, w_N | x_1, \dots, x_m) \\
&= \prod_{j=1}^n (u_j - tw_N) \frac{1}{(n-m)!} \sum_{\sigma \in S_n} \prod_{j=1}^m \prod_{k=x_j+1}^{N-1} (u_{\sigma(j)} - tw_k) \prod_{1 \leq j < k \leq m} \frac{tu_{\sigma(j)} - u_{\sigma(k)}}{u_{\sigma(j)} - u_{\sigma(k)}} (u_{\sigma(j)} u_{\sigma(k)} - 1) \\
&\quad \times \prod_{\substack{m+1 \leq j \leq n \\ 1 \leq k \leq N-1}} (u_{\sigma(j)} - tw_k) \prod_{\substack{m+1 \leq j \leq n \\ 1 \leq k \leq m}} \frac{tu_{\sigma(j)} - u_{\sigma(k)}}{u_{\sigma(j)} - u_{\sigma(k)}} (u_{\sigma(j)} u_{\sigma(k)} - 1) \\
&\quad \times \prod_{j=1}^m \prod_{k=1}^{x_j-1} (u_{\sigma(j)} - w_k) \prod_{m+1 \leq j < k \leq n} (u_{\sigma(j)} u_{\sigma(k)} - t) \\
&\quad \times \prod_{j=1}^m (1-t)(u_{\sigma(j)}^2 - 1) \prod_{j=m+1}^n (Bu_{\sigma(j)} - A) \\
&= \prod_{j=1}^n (u_j - tw_N) F_{N-1,n,m}(u_1, \dots, u_n | w_1, \dots, w_{N-1} | x_1, \dots, x_m), \tag{5.12}
\end{aligned}$$

which is also exactly the recursion relation the wavefunctions

$W_{N,n,m}(u_1, \dots, u_n | w_1, \dots, w_N | x_1, \dots, x_m)$ must satisfy for the case $x_m \neq N$.

Let us finally show Property (4). The case $m = 1$ is proved in [44]. We display the proof here for completeness. This can be shown by making further analysis on the symmetric

function $F_{N,n,m}(\{u\}_n|w_1, \dots, w_N|x_1, \dots, x_m)|_{w_N=t^{-1}u_n}$ for the case $N = m = 1$, $x_1 = 1$. We first write down the case $N = m = 1$, $x_1 = 1$ of (5.7) which we used to prove Property (3) (we denote w_1 as w).

$$\begin{aligned} F_{1,n,1}(\{u\}_n|w|1)|_{w=t^{-1}u_n} &= (1-t)(u_n^2-1) \prod_{j=1}^{n-1} (tu_j - u_n)(u_j u_n - 1) \\ &\quad \times \frac{1}{(n-1)!} \sum_{\sigma' \in S_{n-1}} \prod_{2 \leq j < k \leq n} (u_{\sigma'(j)} u_{\sigma'(k)} - t) \prod_{j=2}^n (Bu_{\sigma'(j)} - A). \end{aligned} \quad (5.13)$$

Since

$$\prod_{2 \leq j < k \leq n} (u_{\sigma'(j)} u_{\sigma'(k)} - t) = \prod_{1 \leq j < k \leq n-1} (u_j u_k - t), \quad (5.14)$$

$$\prod_{j=2}^n (Bu_{\sigma'(j)} - A) = \prod_{j=1}^{n-1} (Bu_j - A), \quad (5.15)$$

the summands are all equal, and the sum in the right hand side of (5.13) becomes $(n-1)! \prod_{1 \leq j < k \leq n-1} (u_j u_k - t) \prod_{j=1}^{n-1} (Bu_j - A)$. Thus, we have the complete factorization

$$\begin{aligned} &F_{1,n,1}(\{u\}_n|w|1)|_{w=t^{-1}u_n} \\ &= (1-t)(u_n^2-1) \prod_{j=1}^{n-1} (tu_j - u_n)(u_j u_n - 1) \\ &\quad \times \frac{1}{(n-1)!} (n-1)! \prod_{1 \leq j < k \leq n-1} (u_j u_k - t) \prod_{j=1}^{n-1} (Bu_j - A) \\ &= (1-t) \prod_{j=1}^{n-1} (tu_j - u_n)(Bu_j - A) \prod_{j=1}^n (u_j u_n - 1) \prod_{1 \leq j < k \leq n-1} (u_j u_k - t), \end{aligned} \quad (5.16)$$

which implies that $F_{1,n,1}(\{u\}_n|w|1)$ satisfies the same property with $W_{1,n,1}(\{u\}_n|w|1)$. Hence, Property (4) for the case $m = 1$ is proved.

The case $m = 0$ can be shown in a similar way. Writing down the case $N = 1$, $m = 0$ of (5.7), one immediately sees that all the summands are equal and we have

$$\begin{aligned} F_{1,n,0}(\{u\}_n|w) &= \frac{1}{n!} \sum_{\sigma \in S_n} \prod_{j=1}^n (u_{\sigma(j)} - tw) \prod_{1 \leq j < k \leq n} (u_{\sigma(j)} u_{\sigma(k)} - t) \prod_{j=1}^n (Bu_{\sigma(j)} - A) \\ &= \frac{1}{n!} n! \prod_{j=1}^n (u_j - tw) \prod_{1 \leq j < k \leq n} (u_j u_k - t) \prod_{j=1}^n (Bu_j - A) \\ &= \prod_{j=1}^n (u_j - tw) \prod_{1 \leq j < k \leq n} (u_j u_k - t) \prod_{j=1}^n (Bu_j - A), \end{aligned} \quad (5.17)$$

which shows that $F_{1,n,0}(\{u\}_n|w)$ is the same with $W_{1,n,0}(\{u\}_n|w)$.

We have proved that the symmetric function $F_{N,n,m}(u_1, \dots, u_n|w_1, \dots, w_N|x_1, \dots, x_m)$ satisfies all the Properties (1), (2), (3) and (4) in Proposition 4.1, hence it is the explicit form of the wavefunctions with triangular boundary $Z_{N,n,m}(u_1, \dots, u_n|w_1, \dots, w_N|x_1, \dots, x_m) = F_{N,n,m}(u_1, \dots, u_n|w_1, \dots, w_N|x_1, \dots, x_m)$. \square

6 Conclusion

In this paper, we introduced an analogue of the wavefunctions of an integrable six-vertex model with triangular boundary. We used the $U_q(sl_2)$ R -matrix as the bulk weights and a triangular K -matrix as the boundary weights. We extended our recent work [44] of the Izergin-Korepin analysis on the domain wall boundary partition function to the wavefunctions and listed the properties about the degree, symmetry, two recursion relations and two initial conditions. We proved that a class of certain explicit symmetric functions satisfies all the required properties, which means that the symmetric functions is nothing but the explicit form which represents the wavefunctions with triangular boundary.

The main motivation for introducing and studying the wavefunctions with triangular boundary is that there are similar combinatorial objects in algebraic combinatorics and Schubert calculus such as the non-intersecting lattice paths and excited Young diagrams [39, 40, 41, 42, 43]. Some of those combinatorial objects can be regarded as the wavefunctions of integrable lattice models with triangular boundary, with the bulk weights given by an R -matrix of an integrable five-vertex model, and the boundary weights given by a triangular K -matrix. Our result can be regarded as an extension of these combinatorial objects by using the six-vertex $U_q(sl_2)$ R -matrix as the bulk weights, and more general triangular K -matrix as the boundary weights. The ordinary wavefunctions [24, 25] is represented by the Grothendieck polynomials of type A Grassmannian variety and their quantum group deformations. See the Appendix for a proof of the ordinary wavefunctions based on the Izergin-Korepin analysis.

We called the class of partition functions treated in this paper as “the wavefunctions”. For the case of ordinary wavefunctions, it is the inner product between the state vector of spins and the off-shell Bethe vector, which becomes the eigenvector of the XXZ spin chain when the Bethe ansatz equations are imposed on the spectral parameters. However, we do not know at this moment if the “off-shell” Bethe vector for the case of triangular boundary becomes an eigenfunction of some Hamiltonian or transfer matrix. This is the reason why we sometimes called the partition functions treated in this paper as “an analogue of the wavefunctions”. It seems worthwhile to investigate whether such Hamiltonian or transfer matrix exist, and if so, what are their explicit forms.

Extending the analysis to various integrable models such as the higher rank models, elliptic models is also an interesting topic. Formulating the wavefunctions of elliptic integrable models [49] by using the dynamical R -matrix as the bulk weights and the triangular elliptic K -matrix [50, 51] as the boundary weights, using the Izergin-Korepin analysis and finding the corresponding elliptic symmetric functions with the help of complex analysis is an interesting work. See [52, 53, 54, 55, 56, 57, 58, 59, 60] for examples on the treatment of the domain wall boundary partition functions and scalar products of the elliptic and trigonometric face models by using various methods developed to analyze those objects. Also interesting topics are to study wavefunctions constructed from the R - and K -matrices of higher dimensional

representations. See [61] for example on this direction.

Acknowledgements

This work was partially supported by grant-in-Aid for Research Activity start-up No. 15H06218 and Scientific Research (C) No. 16K05468.

A Ordinary wavefunctions

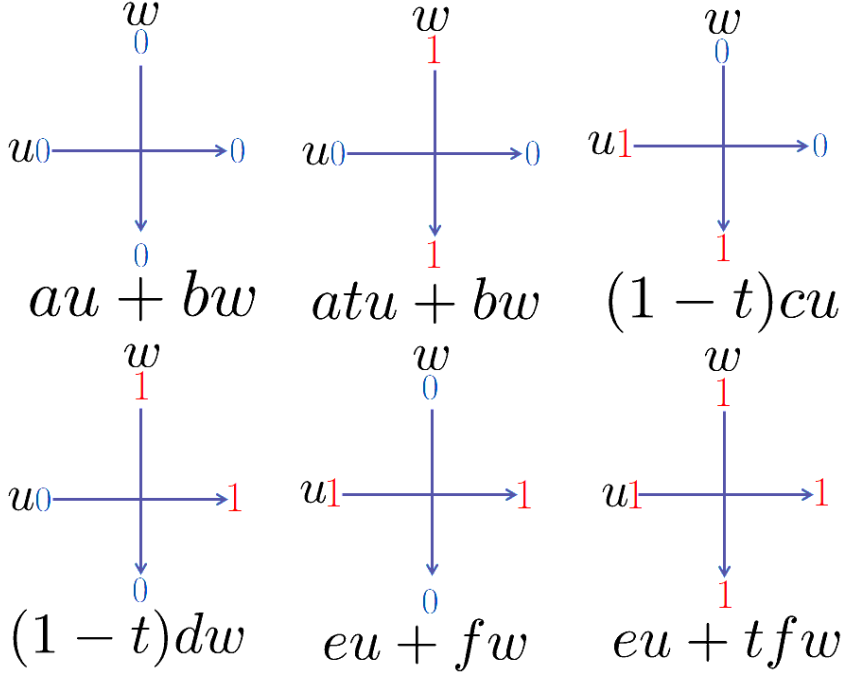

Figure 11: The L -operator $L(u, w)$ (A.1). The horizontal line is the space W , and the vertical line is the space V .

We give here the Izergin-Korepin analysis on the ordinary wavefunctions in this Appendix. We remark that the result presented here can be obtained by applying the general result on the ordinary wavefunctions, for example [29, 30], to the following L -operator presented below. We present a proof based on the Izergin-Korepin analysis here since it is an illustrative example.

We analyze the wavefunctions constructed from the following generalized L -operator [26] (Figure 11)

$$L_{aj}(u, w, a, b, c, d, e, f) = \begin{pmatrix} au + bw & 0 & 0 & 0 \\ 0 & atu + bw & (1-t)cu & 0 \\ 0 & (1-t)dw & eu + fw & 0 \\ 0 & 0 & 0 & eu + tfw \end{pmatrix}, \quad (\text{A.1})$$

acting on the tensor product $W_a \otimes V_j$ where V_j is also a complex two-dimensional vector space, and the parameters a, b, c, d, e and f are constant parameters (do not depend on the spectral parameter u) and must obey the following relations

$$(1-t)cd + af - be = 0, \quad (t^2 - t)cd + t^2af - be = 0. \quad (\text{A.2})$$

If one assumes $t \neq 1$, the relations (A.2) further reduce to

$$cd + af = 0, \quad tcd + be = 0. \quad (\text{A.3})$$

We frequently abbreviate $L_{aj}(u, w, a, b, c, d, e, f)$ as $L_{aj}(u, w)$ for simplicity. The matrix elements of the L -operator (A.1) is explicitly given by

$${}_a\langle 0|_j\langle 0|L_{aj}(u, w)|0\rangle_a|0\rangle_j = au + bw, \quad (\text{A.4})$$

$${}_a\langle 0|_j\langle 1|L_{aj}(u, w)|0\rangle_a|1\rangle_j = atu + bw, \quad (\text{A.5})$$

$${}_a\langle 0|_j\langle 1|L_{aj}(u, w)|1\rangle_a|0\rangle_j = (1-t)cu, \quad (\text{A.6})$$

$${}_a\langle 1|_j\langle 0|L_{aj}(u, w)|0\rangle_a|1\rangle_j = (1-t)dw, \quad (\text{A.7})$$

$${}_a\langle 1|_j\langle 0|L_{aj}(u, w)|1\rangle_a|0\rangle_j = eu + fw, \quad (\text{A.8})$$

$${}_a\langle 1|_j\langle 1|L_{aj}(u, w)|1\rangle_a|1\rangle_j = eu + ftw. \quad (\text{A.9})$$

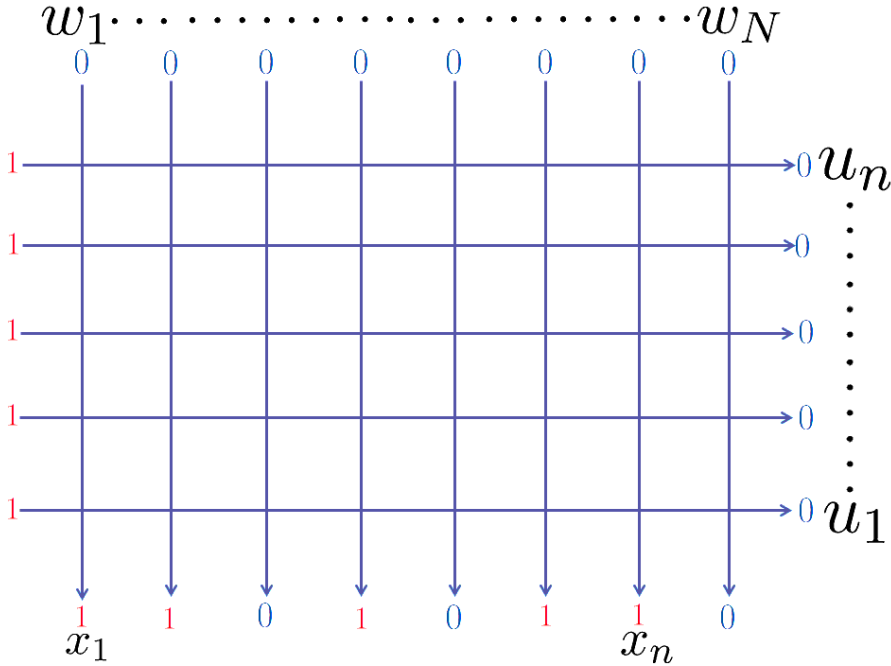

Figure 12: The ordinary wavefunctions $OW_{N,n}(u_1, \dots, u_n | w_1, \dots, w_N | x_1, \dots, x_n)$ (A.19). This figure illustrates the case $N = 8$, $n = 5$, $x_1 = 1$, $x_2 = 2$, $x_3 = 4$, $x_4 = 6$, $x_5 = 7$.

The L -operator (A.1) together with the $U_q(sl_2)$ R -matrix (2.1) satisfies the RLL -type Yang-Baxter relation

$$R_{ab}(u_1, u_2)L_{aj}(u_1, w)L_{bj}(u_2, w) = L_{bj}(u_2, w)L_{aj}(u_1, w)R_{ab}(u_1, u_2), \quad (\text{A.10})$$

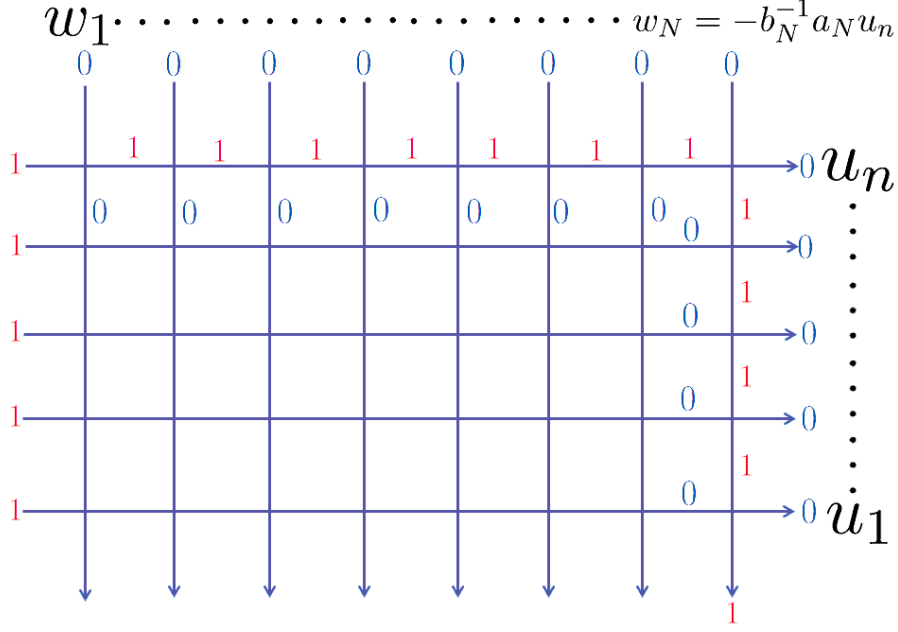

Figure 13: The recursion relation $OW_{N,n}(u_1, \dots, u_n | w_1, \dots, w_N | x_1, \dots, x_n)$, $x_n = N$ evaluated at $w_N = -b_N^{-1} a_N u_n$ (A.20).

acting on $W_a \otimes W_b \otimes V_j$. (A.1) and (A.10) contains the $U_q(sl_2)$ R -matrix (2.1) and the RRR -type Yang-Baxter relation (2.8) as a special case $a = 1$, $b = -t$, $c = 1$, $d = 1$, $e = 1$, $f = -1$.

In the quantum inverse scattering method, what we first do is to construct the monodromy matrix $T_a(u | w_1, \dots, w_N)$ from the L -operator as

$$\begin{aligned} T_a(u | w_1, \dots, w_N) &= L_{aN}(u, w_N) \cdots L_{a1}(u, w_1) \\ &= \begin{pmatrix} A(u | w_1, \dots, w_N) & B(u | w_1, \dots, w_N) \\ C(u | w_1, \dots, w_N) & D(u | w_1, \dots, w_N) \end{pmatrix}_a \in \text{End}(W_a \otimes V_1 \otimes \cdots \otimes V_N). \end{aligned} \quad (\text{A.11})$$

Here, $L_{aj}(u, w_j) = L_{aN}(u, w_j, a_j, b_j, c_j, d_j, e_j, f_j)$, $j = 1, \dots, N$ is the L -operator where a_j, b_j, c_j, d_j, e_j and f_j satisfies

$$c_j d_j + a_j f_j = 0, \quad t c_j d_j + b_j e_j = 0, \quad (\text{A.12})$$

for each j .

The matrix elements of the monodromy matrix

$$A(u | w_1, \dots, w_N) = {}_a \langle 0 | T_a(u | w_1, \dots, w_N) | 0 \rangle_a, \quad (\text{A.13})$$

$$B(u | w_1, \dots, w_N) = {}_a \langle 0 | T_a(u | w_1, \dots, w_N) | 1 \rangle_a, \quad (\text{A.14})$$

$$C(u | w_1, \dots, w_N) = {}_a \langle 1 | T_a(u | w_1, \dots, w_N) | 0 \rangle_a, \quad (\text{A.15})$$

$$D(u | w_1, \dots, w_N) = {}_a \langle 1 | T_a(u | w_1, \dots, w_N) | 1 \rangle_a, \quad (\text{A.16})$$

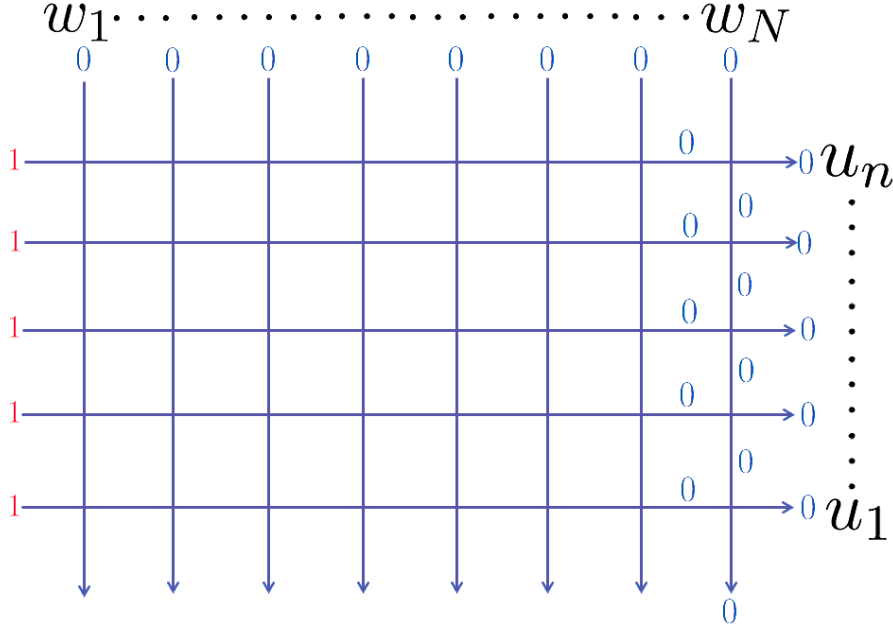

Figure 14: The factorization of $OW_{N,n}(u_1, \dots, u_n | w_1, \dots, w_N | x_1, \dots, x_n)$, $x_n \neq N$ (A.21) .

are $2^N \times 2^N$ matrices acting on the tensor product of the quantum spaces $V_1 \otimes \dots \otimes V_N$.

Particularly important is the B -operator which has the role of creating down spins in the quantum spaces $V_1 \otimes \dots \otimes V_N$. We next introduce the following state vector $|\Phi_{N,n}(u_1, \dots, u_n | w_1, \dots, w_N)\rangle \in V_1 \otimes \dots \otimes V_N$ using the B -operators as

$$|\Phi_{N,n}(u_1, \dots, u_n | w_1, \dots, w_N)\rangle = B(u_1 | w_1, \dots, w_N) \cdots B(u_n | w_1, \dots, w_N) |\Omega\rangle_N, \quad (\text{A.17})$$

where $|\Omega\rangle_N := |0\rangle_1 \otimes \dots \otimes |0\rangle_N \in V_1 \otimes \dots \otimes V_N$ is the vacuum state in the tensor product of quantum spaces. The state vector (A.17) is sometimes called as the off-shell Bethe vector. If one imposes certain constraints on the spectral parameters $\{u_j\}$ called the Bethe ansatz equations, the state vector (A.17) becomes the eigenvectors (Bethe vectors) of the transfer matrix $A(u | w_1, \dots, w_N) + D(u | w_1, \dots, w_N)$ which is a generating function of operators including the Hamiltonian.

Due to the ice rule, each B -operator creates one down spin in the quantum spaces. This fact and that the state vector (A.17) is constructed from N -layers of the B -operators acting on the vacuum state $|\Omega\rangle_N$, the state vector (A.17) is an N -down spin state. To construct a nonvanishing inner product, we introduce the dual n -down spin state

$$\langle x_1 \cdots x_n | = ({}_1\langle 0 | \otimes \cdots \otimes {}_N\langle 0 |) \prod_{j=1}^n \sigma_{x_j}^+ \in V_1^* \otimes \cdots \otimes V_N^*, \quad (\text{A.18})$$

which are states labelling the configurations of down spins $1 \leq x_1 < x_2 < \dots < x_n \leq N$.

The ordinary wavefunctions $OW_{N,n}(u_1, \dots, u_n | w_1, \dots, w_N | x_1, \dots, x_n)$ is defined as the inner product between the state vector $|\Phi_{N,n}(u_1, \dots, u_n | w_1, \dots, w_N)\rangle$ and the n -down spin

state $\langle x_1 \cdots x_n |$

$$OW_{N,n}(u_1, \dots, u_n | w_1, \dots, w_N | x_1, \dots, x_n) = \langle x_1 \cdots x_n | \Phi_{N,n}(u_1, \dots, u_n | w_1, \dots, w_N) \rangle. \quad (\text{A.19})$$

See Figure 12 for a pictorial description of (A.19).

We list the properties of the ordinary wavefunctions $OW_{N,n}(u_1, \dots, u_n | w_1, \dots, w_N | x_1, \dots, x_n)$ by the Izergin-Korepin analysis.

Proposition A.1. *The wavefunctions $OW_{N,n}(u_1, \dots, u_n | w_1, \dots, w_N | x_1, \dots, x_n)$ satisfies the following properties.*

- (1) $OW_{N,n}(u_1, \dots, u_n | w_1, \dots, w_N | x_1, \dots, x_n)$ is a polynomial of degree $n-1$ in w_N if $x_n = N$ and degree n if $x_n \neq N$.
- (2) $OW_{N,n}(u_1, \dots, u_n | w_1, \dots, w_N | x_1, \dots, x_n)$ is symmetric with respect to u_j , $j = 1, \dots, n$.
- (3) The following recursive relations between the wavefunctions hold if $x_n = N$ (Figure 13):

$$\begin{aligned} & OW_{N,n}(u_1, \dots, u_n | w_1, \dots, w_N | x_1, \dots, x_n) \Big|_{w_N = -b_N^{-1} a_N^{-1} u_n} \\ &= (1-t) c_N u_n \prod_{j=1}^{n-1} a_N (t u_j - u_n) \prod_{j=1}^{N-1} (e_j u_n + f_j w_j) \\ & \quad \times OW_{N-1, n-1}(u_1, \dots, u_{n-1} | w_1, \dots, w_{N-1} | x_1, \dots, x_{n-1}). \end{aligned} \quad (\text{A.20})$$

If $x_n \neq N$, the following factorizations hold for the wavefunctions (Figure 14):

$$\begin{aligned} & OW_{N,n}(u_1, \dots, u_n | w_1, \dots, w_N | x_1, \dots, x_n) \\ &= \prod_{j=1}^n (a_N u_j + b_N w_N) OW_{N-1, n}(u_1, \dots, u_n | w_1, \dots, w_{N-1} | x_1, \dots, x_n). \end{aligned} \quad (\text{A.21})$$

- (4) The following holds for the case $N = n = 1$

$$OW_{1,1}(u | w | 1) = (1-t)cu. \quad (\text{A.22})$$

Proof. Properties (1), (2), (3) and (4) can be shown in a similar way with the wavefunctions with triangular boundary or the ordinary domain wall boundary partition functions. We give brief explanations below for each Properties.

Property (3) can be shown by using the graphical representation of the ordinary wavefunctions, ${}_a \langle 0 | {}_N \langle 0 | L_{aN}(u_n, -b_N^{-1} a_N^{-1} u_n, a_N, b_N, c_N, d_N, e_N, f_N) | 0 \rangle_a | 0 \rangle_N = 0$ and the ice rule. See Figures 13 and 14 which explains (A.20) and (A.21) respectively. The factorization of the wavefunctions (A.21) also shows Property (1) for the case $x_n \neq N$.

Property (1) for the case $x_n = N$ can be shown by inserting the completeness relation in one spin down state sector.

Property (2) can be shown by the railroad argument using the Yang-Baxter relation. Equivalently, it follows from the commutativity of the B -matrix

$$[B(u_1 | w_1, \dots, w_N), B(u_2 | w_1, \dots, w_N)] = 0. \quad (\text{A.23})$$

This commutativity follows from writing down a matrix element of the equality of the intertwining relation between the monodromy matrices

$$R_{ab}(u_1, u_2)T_a(u_1, w)T_b(u_2, w) = T_b(u_2, w)T_a(u_1, w)R_{ab}(u_1, u_2), \quad (\text{A.24})$$

which can be obtained by using the *RLL* relation (A.10) repeatedly.

Property (4) is obvious since $OW_{1,1}(u|w|1) = {}_a\langle 0|_1\langle 1|L_{a1}(u, w, a, b, c, d, e, f)|1\rangle_a|0\rangle_1 = (1-t)cu$. \square

Definition A.2. We define the following symmetric function

$OF_{N,n}(u_1, \dots, u_n|w_1, \dots, w_N|x_1, \dots, x_n)$ which depends on the symmetric variables u_1, \dots, u_n , complex parameters w_1, \dots, w_N and integers x_1, \dots, x_n satisfying $1 \leq x_1 < \dots < x_n \leq N$,

$$\begin{aligned} & OF_{N,n}(u_1, \dots, u_n|w_1, \dots, w_N|x_1, \dots, x_n) \\ &= \sum_{\sigma \in S_n} \prod_{j=1}^n \prod_{k=x_j+1}^N (a_k u_{\sigma(j)} + b_k w_k) \prod_{1 \leq j < k \leq n} \frac{t u_{\sigma(j)} - u_{\sigma(k)}}{u_{\sigma(j)} - u_{\sigma(k)}} \\ & \quad \times \prod_{j=1}^n \prod_{k=1}^{x_j-1} (e_k u_{\sigma(j)} + f_k w_k) \prod_{j=1}^n (1-t)c_{x_j} u_{\sigma(j)}. \end{aligned} \quad (\text{A.25})$$

We make a comment on the symmetric function $OF_{N,n}(u_1, \dots, u_n|w_1, \dots, w_N|x_1, \dots, x_n)$. If one takes the homogeneous limit $w_j = 1$, $j = 1, \dots, N$ and the following specialization $a_j = 1$, $b_j = t\beta$, $c_j = 1$, $d_j = 1$, $e_j = -\beta^{-1}$, $f_j = -1$, $j = 1, \dots, N$, the symmetric function (A.25) becomes

$$\begin{aligned} & OF_{N,n}(u_1, \dots, u_n|1, \dots, 1|x_1, \dots, x_n) \\ &= \prod_{j=1}^n \frac{(1-t)u_j(u_j + t\beta)^N}{-\beta^{-1}u_j - 1} \prod_{1 \leq j < k \leq n} \frac{t u_j - u_k}{u_j - u_k} \\ & \quad \times \sum_{\sigma \in S_n} \prod_{\substack{1 \leq j < k \leq n \\ \sigma(j) > \sigma(k)}} \frac{u_{\sigma(k)} - t u_{\sigma(j)}}{t u_{\sigma(k)} - u_{\sigma(j)}} \prod_{j=1}^n \left(\frac{-\beta^{-1}u_{\sigma(j)} - 1}{u_{\sigma(j)} + t\beta} \right)^{x_j}. \end{aligned} \quad (\text{A.26})$$

If one furthermore set the parameter of the quantum group t to $t = 0$, (A.26) essentially becomes the Grothendieck polynomials

$$OF_{N,n}(u_1, \dots, u_n|1, \dots, 1|x_1, \dots, x_n)|_{t=0} = (-\beta)^{-n(n-1)/2} \prod_{j=1}^n u_j^N G_\lambda(\mathbf{z}; \beta). \quad (\text{A.27})$$

Here, $G_\lambda(\mathbf{z}; \beta)$ is the β -Grothendieck polynomials of type *A* Grassmannian variety [42, 62, 63, 64, 65, 66], which is known to have the following determinant form

$$G_\lambda(\mathbf{z}; \beta) = \frac{\det_n(z_j^{\lambda_k + n - k} (1 + \beta z_j)^{k-1})}{\prod_{1 \leq j < k \leq n} (z_j - z_k)}. \quad (\text{A.28})$$

In the correspondence (A.27), the symmetric variables $\mathbf{z} = \{z_1, \dots, z_n\}$ for the Grothendieck polynomials $G_\lambda(\mathbf{z}; \beta)$ and the spectral parameters u_1, \dots, u_n of the symmetric functions

$OF_{N,n}(u_1, \dots, u_n | 1, \dots, 1 | x_1, \dots, x_n)|_{t=0}$ are related by the correspondence $z_j = -\beta^{-1} - u_j^{-1}$, $j = 1, \dots, n$. Also, the Young diagrams $\lambda = (\lambda_1, \lambda_2, \dots, \lambda_n) \in \mathbb{Z}^n$ ($N - n \geq \lambda_1 \geq \lambda_2 \geq \dots \geq \lambda_n \geq 0$) in $G_\lambda(\mathbf{z}; \beta)$ and the sequence of integers x_1, \dots, x_n satisfying $1 \leq x_1 < \dots < x_n \leq N$ in $OF_{N,n}(u_1, \dots, u_n | 1, \dots, 1 | x_1, \dots, x_n)|_{t=0}$ are connected by the translation rule $\lambda_j = x_{n-j+1} - n + j - 1$, $j = 1, \dots, n$.

We have the following correspondence between the ordinary wavefunctions of the six-vertex model and the symmetric function $OF_{N,n}(u_1, \dots, u_n | w_1, \dots, w_N | x_1, \dots, x_n)$.

Theorem A.3. *The ordinary wavefunctions of the six-vertex model*

$OZ_{N,n}(u_1, \dots, u_n | w_1, \dots, w_N | x_1, \dots, x_n)$ is explicitly expressed as the symmetric function $OF_{N,n}(u_1, \dots, u_n | w_1, \dots, w_N | x_1, \dots, x_n)$

$$OZ_{N,n}(u_1, \dots, u_n | w_1, \dots, w_N | x_1, \dots, x_n) = OF_{N,n}(u_1, \dots, u_n | w_1, \dots, w_N | x_1, \dots, x_n). \quad (\text{A.29})$$

Proof. We prove this theorem by showing that the symmetric function (A.25)

$OF_{N,n}(u_1, \dots, u_n | w_1, \dots, w_N | x_1, \dots, x_n)$ satisfies all the four Properties in Proposition A.1. The proof goes along the same line as the case with triangular boundary, but is much simpler.

To show Property (1), first note that the factor $\prod_{j=1}^n \prod_{k=x_j+1}^N (a_k u_{\sigma(j)} + b_k w_k)$ in

$OF_{N,n}(u_1, \dots, u_n | w_1, \dots, w_N | x_1, \dots, x_n)$ is a polynomial of degree $n - 1$ in w_N if $x_n = N$ and degree n if $x_n \neq N$. We can also immediately see that the dependence on w_N just only comes from this factor, hence Property (1) is proved.

It is also easy to see that $OF_{N,n}(u_1, \dots, u_n | w_1, \dots, w_N | x_1, \dots, x_n)$ is symmetric with respect to u_j , $j = 1, \dots, n$ from the fact that the sum is over all permutations of the variables u_j , $j = 1, \dots, n$.

Next we show Property (3). We first prove the function $OF_{N,n}(\{u\}_n | w_1, \dots, w_N | x_1, \dots, x_n)$ satisfies (A.20) for the case $x_n = N$. In this case, we first note that the factor

$$\prod_{j=1}^n \prod_{k=x_j+1}^N (a_k u_{\sigma(j)} + b_k w_k), \quad (\text{A.30})$$

in each summand essentially becomes

$$\prod_{j=1}^{n-1} \prod_{k=x_j+1}^N (a_k u_{\sigma(j)} + b_k w_k). \quad (\text{A.31})$$

Concentrating on the factor $\prod_{j=1}^{n-1} (a_N u_{\sigma(j)} + b_N w_N)$ from (A.31), one finds this factor vanishes

unless σ satisfies $\sigma(n) = n$ if one substitutes $w_N = -b_N^{-1} a_N u_n$.

Therefore, only the summands satisfying $\sigma(n) = n$ in (A.25) survive after the substitution $w_N = -b_N^{-1} a_N u_n$. Keeping this in mind, one rewrites $OF_{N,n}(\{u\}_n | w_1, \dots, w_N | x_1, \dots, x_n)$ evaluated at $w_N = -b_N^{-1} a_N u_n$ by using the symmetric group S_{n-1} where every $\sigma' \in S_{n-1}$

satisfies $\{\sigma'(1), \dots, \sigma'(n-1)\} = \{1, \dots, n-1\}$ as follows:

$$\begin{aligned}
& OF_{N,n}(u_1, \dots, u_n | w_1, \dots, w_N | x_1, \dots, x_n) \Big|_{w_N = -b_N^{-1} a_N u_n} \\
&= \sum_{\sigma' \in S_{n-1}} \prod_{j=1}^{n-1} \prod_{k=x_j+1}^{N-1} (a_k u_{\sigma'(j)} + b_k w_k) \prod_{j=1}^{n-1} a_N (u_{\sigma'(j)} - u_n) \\
&\times \prod_{1 \leq j < k \leq n-1} \frac{t u_{\sigma'(j)} - u_{\sigma'(k)}}{u_{\sigma'(j)} - u_{\sigma'(k)}} \prod_{j=1}^{n-1} \frac{t u_{\sigma'(j)} - u_n}{u_{\sigma'(j)} - u_n} \prod_{j=1}^{n-1} \prod_{k=1}^{x_j-1} (e_k u_{\sigma'(j)} + f_k w_k) \prod_{k=1}^{N-1} (e_k u_n + f_k w_k) \\
&\times (1-t) c_N u_n \prod_{j=1}^{n-1} (1-t) c_{x_j} u_{\sigma'(j)}. \tag{A.32}
\end{aligned}$$

One easily notes that the factors $\prod_{k=1}^{N-1} (e_k u_n + f_k w_k)$ and $(1-t) c_N u_n$ in the sum are independent of the permutation S'_{n-1} . One also finds the factor $\prod_{j=1}^{n-1} \frac{t u_{\sigma'(j)} - u_n}{u_{\sigma'(j)} - u_n} \prod_{j=1}^{n-1} a_N (u_{\sigma'(j)} - u_n)$ can be simplified as

$$\prod_{j=1}^{n-1} \frac{t u_{\sigma'(j)} - u_n}{u_{\sigma'(j)} - u_n} \prod_{j=1}^{n-1} a_N (u_{\sigma'(j)} - u_n) = \prod_{j=1}^{n-1} a_N (t u_{\sigma'(j)} - u_n) = \prod_{j=1}^{n-1} a_N (t u_j - u_n). \tag{A.33}$$

Thus, (A.32) can be rewritten furthermore as

$$\begin{aligned}
& OF_{N,n}(u_1, \dots, u_n | w_1, \dots, w_N | x_1, \dots, x_n) \Big|_{w_N = -b_N^{-1} a_N u_n} \\
&= (1-t) c_N u_n \prod_{j=1}^{n-1} a_N (t u_j - u_n) \prod_{j=1}^{N-1} (e_j u_n + f_j w_j) \sum_{\sigma' \in S_{n-1}} \prod_{j=1}^{n-1} \prod_{k=x_j+1}^{N-1} (a_k u_{\sigma'(j)} + b_k w_k) \\
&\times \prod_{1 \leq j < k \leq n-1} \frac{t u_{\sigma'(j)} - u_{\sigma'(k)}}{u_{\sigma'(j)} - u_{\sigma'(k)}} \prod_{j=1}^{n-1} \prod_{k=1}^{x_j-1} (e_k u_{\sigma'(j)} + f_k w_k) \prod_{j=1}^{n-1} (1-t) c_{x_j} u_{\sigma'(j)}. \tag{A.34}
\end{aligned}$$

Since

$$\begin{aligned}
& \sum_{\sigma' \in S_{n-1}} \prod_{j=1}^{n-1} \prod_{k=x_j+1}^{N-1} (a_k u_{\sigma'(j)} + b_k w_k) \\
&\times \prod_{1 \leq j < k \leq n-1} \frac{t u_{\sigma'(j)} - u_{\sigma'(k)}}{u_{\sigma'(j)} - u_{\sigma'(k)}} \prod_{j=1}^{n-1} \prod_{k=1}^{x_j-1} (e_k u_{\sigma'(j)} + f_k w_k) \prod_{j=1}^{n-1} (1-t) c_{x_j} u_{\sigma'(j)} \\
&= OF_{N-1, n-1}(u_1, \dots, u_{n-1} | w_1, \dots, w_{N-1} | x_1, \dots, x_{n-1}), \tag{A.35}
\end{aligned}$$

one finds that (A.34) is nothing but the following recursion relation for the symmetric function

$$\begin{aligned}
& OF_{N,n}(u_1, \dots, u_n | w_1, \dots, w_N | x_1, \dots, x_n) \\
& \quad OF_{N,n}(u_1, \dots, u_n | w_1, \dots, w_N | x_1, \dots, x_n) \Big|_{w_N = -b_N^{-1} a_N^{-1} u_n} \\
& = (1-t) c_N u_n \prod_{j=1}^{n-1} a_N (t u_j - u_n) \prod_{j=1}^{N-1} (e_j u_n + f_j w_j) \\
& \quad \times OF_{N-1, n-1}(u_1, \dots, u_{n-1} | w_1, \dots, w_{N-1} | x_1, \dots, x_{n-1}), \tag{A.36}
\end{aligned}$$

which is exactly the same recursion relation the wavefunctions

$OW_{N,n}(u_1, \dots, u_n | w_1, \dots, w_N | x_1, \dots, x_n)$ must satisfy. Hence, Property (3) for the case $x_n = N$ is proved.

The case $x_n \neq N$ can be shown in a similar but much simpler way. Rewriting $OF_{N,n}(u_1, \dots, u_n | w_1, \dots, w_N | x_1, \dots, x_n)$ as

$$\begin{aligned}
& OF_{N,n}(u_1, \dots, u_n | w_1, \dots, w_N | x_1, \dots, x_n) \\
& = \sum_{\sigma \in S_n} \prod_{j=1}^n \prod_{k=x_j+1}^{N-1} (a_k u_{\sigma(j)} + b_k w_k) \prod_{j=1}^n (a_N u_{\sigma(j)} + b_N w_N) \\
& \quad \times \prod_{1 \leq j < k \leq n} \frac{t u_{\sigma(j)} - u_{\sigma(k)}}{u_{\sigma(j)} - u_{\sigma(k)}} \prod_{j=1}^n \prod_{k=1}^{x_j-1} (e_k u_{\sigma(j)} + f_k w_k) \prod_{j=1}^n (1-t) c_{x_j} u_{\sigma(j)}, \tag{A.37}
\end{aligned}$$

and noting

$$\prod_{j=1}^n (a_N u_{\sigma(j)} + b_N w_N) = \prod_{j=1}^n (a_N u_j + b_N w_N), \tag{A.38}$$

we can take this factor out of the sum in (A.37) and we have

$$\begin{aligned}
& OF_{N,n}(u_1, \dots, u_n | w_1, \dots, w_N | x_1, \dots, x_n) \\
& = \prod_{j=1}^n (a_N u_j + b_N w_N) \sum_{\sigma \in S_n} \prod_{j=1}^n \prod_{k=x_j+1}^{N-1} (a_k u_{\sigma(j)} + b_k w_k) \\
& \quad \times \prod_{1 \leq j < k \leq n} \frac{t u_{\sigma(j)} - u_{\sigma(k)}}{u_{\sigma(j)} - u_{\sigma(k)}} \prod_{j=1}^n \prod_{k=1}^{x_j-1} (e_k u_{\sigma(j)} + f_k w_k) \prod_{j=1}^n (1-t) c_{x_j} u_{\sigma(j)} \\
& = \prod_{j=1}^n (a_N u_j + b_N w_N) OF_{N-1, n}(u_1, \dots, u_n | w_1, \dots, w_{N-1} | x_1, \dots, x_n), \tag{A.39}
\end{aligned}$$

which is also exactly the recursion relation the ordinary wavefunctions

$OF_{N,n}(u_1, \dots, u_n | w_1, \dots, w_N | x_1, \dots, x_n)$ must satisfy for the case $x_n \neq N$.

It is trivial to check that $OW_{N,n}(u_1, \dots, u_n | w_1, \dots, w_N | x_1, \dots, x_n)$ satisfies $OW_{1,1}(u|w|1) = (1-t)cu$, hence Property (4) is shown.

Since we have proved that the symmetric function $OF_{N,n}(u_1, \dots, u_n | w_1, \dots, w_N | x_1, \dots, x_n)$ satisfies all the Properties (1), (2), (3) and (4) in Proposition A.1, we conclude it is the explicit form of the ordinary wavefunctions

$$OZ_{N,n}(u_1, \dots, u_n | w_1, \dots, w_N | x_1, \dots, x_n) = OF_{N,n}(u_1, \dots, u_n | w_1, \dots, w_N | x_1, \dots, x_n). \quad \square$$

References

- [1] Bethe, H.: Zur Theorie der Metalle I. Eigenwerte und Eigenfunktionen der linearen Atomkette. *Z. Phys.* **71**, 205-226 (1931)
- [2] Faddeev, L.D., Sklyanin, E.K., and Takhtajan, E.K.: The quantum inverse problem I. *Theor. Math. Phys.* **40**, 194-220 (1979)
- [3] Baxter, R.J.: *Exactly Solved Models in Statistical Mechanics*. Academic Press, London (1982)
- [4] Korepin, V.E., Bogoliubov, N.M., and Izergin, A.G.: *Quantum Inverse Scattering Method and Correlation functions*. Cambridge University Press, Cambridge (1993)
- [5] Korepin, V.E.: Calculation of norms of Bethe wave functions. *Commun. Math. Phys.* **86**, 391-418 (1982)
- [6] Izergin, A.: Partition function of the six-vertex model in a finite volume. *Sov. Phys. Dokl.* **32**, 878-879 (1987)
- [7] Bressoud, D.: *Proofs and confirmations: The story of the alternating sign matrix conjecture*. MAA Spectrum, Mathematical Association of America, Washington, DC, (1999)
- [8] Kuperberg, G.: Another proof of the alternating-sign matrix conjecture. *Int. Math. Res. Not.* **3** 123-150 (1996)
- [9] Kuperberg, G.: Symmetry classes of alternating-sign matrices under one roof. *Ann. Math.* **156** 835-866 (2002)
- [10] Okada, S.: Enumeration of symmetry classes of alternating sign matrices and characters of classical groups. *J. Alg. Comb.* **23** 43-69 (2001)
- [11] Foda, O., Wheeler, M., and Zuparic, M.: Domain wall partition functions and KP. *J. Stat. Mech.* P03017 (2009)
- [12] Colomo, F., and Pronko, A.G.: Square ice, alternating sign matrices and classical orthogonal polynomials. *J. Stat. Mech.:Theor. Exp.* P01005 (2005)
- [13] Korepin, V., Zinn-Justin, P.: Thermodynamic limit of the six-vertex model with domain wall boundary conditions. *J. Phys. A* **33** 7053 (2000)
- [14] Bleher, P., and Liechty, K.: Exact Solution of the Six-Vertex Model with Domain Wall Boundary Conditions. Critical Line between Ferroelectric and Disordered Phases. *J. Stat. Phys.* **134** 463 (2009)
- [15] Ribeiro, G.A.P., and Korepin, V.: Thermodynamic limit of the six-vertex model with reflecting end. *J. Phys. A: Math. and Theor.* **48** 045205 (2015)
- [16] Tsuchiya, O.: Determinant formula for the six-vertex model with reflecting end. *J. Math. Phys.* **39**, 5946-5951 (1998)

- [17] Hamel, A., and King, R.C., Symplectic shifted tableaux and deformations of Weyl's denominator for $sp(2n)$. *J. Algebraic Comb.* **16**, 269-300 (2002)
- [18] Hamel, A., and King, R.C., U-Turn Alternating Sign Matrices, Symplectic Shifted Tableaux and their Weighted Enumeration. *J. Algebraic Comb.* **21**, 395-421 (2005)
- [19] Bogoliubov, N.M.: Boxed Plane Partitions as an Exactly Solvable Boson Model. *J. Phys. A: Math. Gen.* **38** 9415-9430 (2005)
- [20] Betea, D., and Wheeler, M.: Refined Cauchy and Littlewood identities, plane partitions and symmetry classes of alternating sign matrices. *J. Comb. Th. Ser. A* **137**, 126-165. (2016)
- [21] Betea, D., Wheeler, M., and Zinn-Justin, P.: Refined Cauchy/Littlewood identities and six-vertex model partition functions: II. Proofs and new conjectures. *J. Alg. Comb.* **42**, 555-603 (2015)
- [22] Wheeler, M., and Zinn-Justin P.: Refined Cauchy/Littlewood identities and six-vertex model partition functions: III. Deformed bosons. *Adv. Math.* **299** 543-600 (2016)
- [23] van Diejen, J.F., and Emsiz, E.: Orthogonality of Bethe Ansatz eigenfunctions for the Laplacian on a hyperoctahedral Weyl alcove. *Commun. Math. Phys.* **350**, 1017-1067 (2017)
- [24] Motegi, K., and Sakai, K.: Vertex models, TASEP and Grothendieck polynomials. *J. Phys. A: Math. Theor.* **46**, 355201 (2013)
- [25] Motegi, K.: Combinatorial properties of symmetric polynomials from integrable vertex models in finite lattice. arXiv:1608.02269
- [26] Motegi, K., and Sakai, K.: K -theoretic boson-fermion correspondence and melting crystals. *J. Phys. A: Math. Theor.* **47**, 445202 (2014)
- [27] Korff, C.: Quantum cohomology via vicious and osculating walkers. *Lett. Math. Phys.* **104**, 771-810. (2014)
- [28] Gorbounov, V., and Korff, C.: Quantum Integrability and Generalised Quantum Schubert Calculus. arXiv:1408.4718
- [29] Borodin, A.: On a family of symmetric rational functions. *Adv. in Math.* **306**, 973-1018 (2017)
- [30] Borodin, A., and Petrov, L.: Higher spin six vertex model and symmetric rational functions. *Sel. Math. New Ser.* pp 1-124 (2016)
- [31] Takeyama, Y.: On the eigenfunctions for the multi-species q -Boson system. arXiv:1606.00578
- [32] Wheeler M., and Zinn-Justin, P.: Littlewood-Richardson coefficients for Grothendieck polynomials from integrability. arXiv:1607.02396

- [33] Brubaker, B., Bump, D., and Friedberg, S.: Schur polynomials and the Yang-Baxter equation. *Commun. Math. Phys.* **308**, 281-301 (2011)
- [34] Ivanov, D.: Symplectic Ice. in: Multiple Dirichlet series, L -functions and automorphic forms, vol 300 of *Progr. Math.* Birkhäuser/Springer, New York, 205-222 (2012)
- [35] Brubaker, B., Bump, D., Chinta, G., and Gunnells, P.E.: Metaplectic Whittaker Functions and Crystals of Type B. in: Multiple Dirichlet series, L -functions and automorphic forms, vol 300 of *Progr. Math.* Birkhäuser/Springer, New York, 93-118 (2012)
- [36] Tabony, S.J.: Deformations of characters, metaplectic Whittaker functions and the Yang-Baxter equation, PhD. Thesis, Massachusetts Institute of Technology, USA (2011)
- [37] Bump, D., McNamara, P., and Nakasuji, M.: Factorial Schur functions and the Yang-Baxter equation. *Comm. Math. Univ. St. Pauli* **63**, 23-45 (2014)
- [38] Motegi, K.: Dual wavefunction of the Felderhof model. *Lett. Math. Phys.* pp 1-29 (2017)
- [39] Stembridge, J.: Nonintersecting paths, Pfaffians, and plane partitions. *Adv. Math.* **83** 96-131 (1990)
- [40] Okada, S.: Partially strict shifted plane partitions. *J. Combin. Theory Ser. A* **53** 143-156 (1990)
- [41] Ikeda, T., and Naruse, H.: Excited Young diagrams and equivariant Schubert calculus. *Trans. Amer. Math. Soc.* **361** 5193-5221 (2009)
- [42] Ikeda, T., and Naruse, H.: K -theoretic analogues of factorial Schur P - and Q -functions. *Adv. in Math.* **243**, 22 (2013)
- [43] Hamel, A.M., and King, R.C.: Tokuyama's Identity for Factorial Schur P and Q Functions. *Elect. J. Comb.* **22**, 2 P2.42 (2015)
- [44] Motegi, K.: Domain wall boundary partition function of the six-vertex model with triangular boundary. arXiv: arXiv:1703.06250
- [45] Drinfeld, V.: Hopf algebras and the quantum Yang-Baxter equation. *Sov. Math. Dokl.* **32**, 254-258 (1985)
- [46] Jimbo, M.: A q -difference analogue of $U(\mathfrak{g})$ and the Yang-Baxter equation. *Lett. Math. Phys.* **10**, 63-69 (1985)
- [47] Sklyanin, E.: Boundary conditions for integrable quantum systems. *J. Phys. A: Math. and Gen.* **21**, 2375 (1988)
- [48] Wheeler, M.: An Izergin-Korepin procedure for calculating scalar products in the six-vertex model. *Nucl. Phys. B* **852** 469-507 (2011)
- [49] Baxter, R.J.: Partition function of the eight-vertex lattice model. *Ann. Phys.* **70**, 193-228 (1972)

- [50] Vega, H.J.de, Gonzalez-Ruiz, A.: Boundary K -matrices for the XYZ, XXZ and XXX spin chains. *J. Phys. A* **27** 6129-6137 (1994)
- [51] Inami, T., Konno, H.: Integrable XYZ spin chain with boundaries. *J. Phys. A* **27** L913-L918 (1994)
- [52] Rosengren, H.: An Izergin-Korepin-type identity for the 8VSOS model, with applications to alternating sign matrices. *Adv. Appl. Math.* **43** 137-155 (2009)
- [53] Pakuliak, S., Rubtsov, V., and Silantyev, A.: SOS model partition function and the elliptic weight functions. *J. Phys. A:Math. Theor.* **41** 295204 (2008)
- [54] Filali, F. and Kitanine, N.: Partition function of the trigonometric SOS model with reflecting end. *J. Stat. Mech.* L06001 (2010)
- [55] Yang, W.-L., and Zhang, Y.-Z.: Partition function of the eight-vertex model with domain wall boundary condition. *J. Math. Phys.* **50** 083518 (2009)
- [56] Yang, W.-L., Chen, X., Feng, J., Hao, K., Shi, K.-J., Sun C.-Y., Yang Z.-Y., and Zhang Y.-Z.: Domain wall partition function of the eight-vertex model with a non-diagonal reflecting end. *Nucl. Phys. B* **847** 367-386 (2011)
- [57] Yang, W.-L., Chen, X., Feng, J., Hao, K., Wu, K., Yang Z.-Y., and Zhang Y.-Z.; Scalar products of the open XYZ chain with non-diagonal boundary terms. *Nucl. Phys. B* **848** 523-544 (2011)
- [58] Galleas, W.: Multiple integral representation for the trigonometric SOS model with domain wall boundaries. *Nucl. Phys.* **858** 117-141 (2012)
- [59] Galleas, W.: Refined functional relations for the elliptic SOS model. *Nucl. Phys.* **867** 855-871 (2013)
- [60] Galleas, W.: Elliptic solid-on-solid model's partition function as a single determinant. *Phys. Rev. E* **94** 010102(R) (2016)
- [61] Garbali, A.: The domain wall partition function for the Izergin-Korepin nineteen-vertex model at a root of unity. *J. Stat. Mech.* 033112 (2016)
- [62] Lascoux, A., and Schützenberger, M.: Structure de Hopf de l'anneau de cohomologie et de l'anneau de Grothendieck d'une variété de drapeaux, *C. R. Acad. Sci. Paris Sér. I Math* **295** 629 (1982)
- [63] Fomin, S., and Kirillov, A.N.: Grothendieck polynomials and the Yang-Baxter equation, *Proc. 6th Internat. Conf. on Formal Power Series and Algebraic Combinatorics, DIMACS* 183-190 (1994)
- [64] Buch, A.S.: A Littlewood-Richardson rule for the K -theory of Grassmannians, *Acta. Math.* **189** 37 (2002)
- [65] Ikeda, T., and Shimazaki, T.: A proof of K -theoretic Littlewood-Richardson rules by Bender-Knuth-type involutions, *Math. Res. Lett.* **21** 333 (2014)
- [66] McNamara, P.J.: Factorial Grothendieck Polynomials, *Electron. J. Combin.* **13** 71 (2006)