

On the Spectra of Symmetric Cylindrical Constructs

Amir Daneshgar

Department of Mathematical Sciences

Sharif University of Technology

P.O. Box 11155-9415, Tehran, Iran

daneshagr@sharif.ir

Ali Taherkhani

Department of Mathematics

Institute for Advanced Studies in Basic Sciences

P.O. Box 45195-1159, Zanjan 45195, Iran

ali.taherkhani@iasbs.ac.ir

Abstract

In this article, following [A. Daneshgar, M. Hejrati, M. Madani, *On cylindrical graph construction and its applications*, EJC, 23(1) p1.29, 45, 2016] we study the spectra of symmetric cylindrical constructs, generalizing some well-known results on the spectra of a variety of graph products, graph subdivisions by V. B. Mnuhin (1980) and the spectra of GI-graphs (see [M. Conder, T. Pisanski, and A. Žitnik, *GI-graphs: a new class of graphs with many symmetries*, 40, 209–231 (2014)] and references therein). In particular, we show that for bsymmetric cylinders with no internal vertex the spectra is actually equal to the eigenvalues of a perturbation of the base, and using this, we study the spectra of sparsifications of complete graphs by tree-cylinders. We also, show that a specific version of this construction gives rise to a class of highly symmetric graphs as a generalization of Petersen and Coxeter graphs.

Keywords: Graph spectra, Ramanujan graph, cylindrical construction, expander.

Subject classification: 05C

1 Introduction

Nowadays, *graph amalgams* is a classic chapter in graph theory while study of graph products and their spectra goes back to the early days of graph theory [8]. The cylindrical graph construction as a generalized edge-replacement procedure, introduced in [5] (also see [11]), is a graph amalgam that unifies a large number of graph constructions including different kinds of products. On the other hand, study of graphs through assigning matrices that encode structural properties is also an old section of graph theory with a large intersection with discrete spectral geometry and its methods. These along with the main duality proved in [5] leads to the following basic question:

“How far the cylindrical amalgam generalizes the tensor product of matrices and its properties?”

From another point of view, looking for highly connected relatively sparse graphs is a highlight in graph theory, not only because of introducing interesting and deep problems but also for its foundational impact in modern computer science and its applications (e.g. see [10]). In this regard, strictly speaking, the theory of expander graphs looks for methods of constructing highly connected sparse graphs with a relatively low spread of the spectrum. Hence, again, cylindrical construction, as a method that can be applied to sparsify highly connected dense graphs is a procedure that ought to be studied from a spectral geometric viewpoint. This approach also raises the following question:

“What can be said about the spectra of a cylindrical construct based on the spectra of the base-graph and the cylinder?”

Considering classical results in spectral geometry and recent nonconstructive results of Marcus, Spielman and Srivastava [12] on the existence of Ramanujan graphs as iterated 2-lifts, provide sufficient evidence supporting that construction of extremal highly connected sparse graphs are closely related to noncommutative structures where these subjects and corresponding algebras constitute a large and active area of research in modern geometry. However, again considering 2-lifts as cylindrical constructs gives rise to the following question:

“How far can one get close to the extremal constructions through commutative substructures?”

This article is an attempt to give some partial answers to above mentioned questions. In Section 2.1, on the one hand, we consider a subclass of cylindrical constructs that somehow can be considered as generalized tensor products. Our basic goal in this section is to introduce a general result (Theorem 1) that describes the spectrum of the construct in terms of the spectra of its components. On the other hand, in this regard, we introduce the concept of a *commutative k -decomposition* where in our main theorem the base-graph is decomposed into a commutative set of subgraphs by the corresponding labeling induced by the twists. We not only deduce a number of known results as corollaries of our main theorem, but also, in our opinion, another interesting aspect of Theorem 1 is to introduces a deep connection between the theory of graph decompositions and the theory of graph spectra.

In the last section, using the concept of tree-cylinders introduced in [11], we consider a special family of cylindrical constructions in which complete graphs are sparsified by regular tree-cylinders. In this section we analyze the spectra of such constructions in detail and we will see that such a study is closely related to the study of the spectra of regular trees in which leaves are connected to each other in a predefined way which is related to the twists of the construction. In this regard, we introduce a class of highly symmetric sparse graphs whose spectra is equal to the spectra of perturbed regular trees. This may also be interesting when one considers a recent result of N. Alon [2] (also see [1]) in which it is proved that there exist highly connected sparse graphs within the family of graphs constructed by adding random edges to a regular tree connecting leaves to their ancestors.

To add a couple of words on notations, we note that hereafter we only deal with finite simple graphs which are referred to using math-Roman font as H , where matrices are referred to by italic-Roman font as H . In the sequel, K_n is the complete graph on n vertices and P_n is the path of length $n - 1$.

The symbols I and J stand for the identity matrix and the all-one matrix, respectively, and we define

$$\bar{I} \stackrel{\text{def}}{=} \begin{bmatrix} 0 & & 1 \\ & \ddots & \\ 1 & & 0 \end{bmatrix}$$

where the dimensions of these matrices are assumed to be clear from the context. The transpose of a matrix H is denoted by H^* and the characteristic polynomial of a matrix H in terms of the variable x is defined as $\phi(H, x) \stackrel{\text{def}}{=} \det(xI - H)$.

A 2×2 block matrix

$$A = \begin{bmatrix} A_{1,1} & A_{1,2} \\ A_{2,1} & A_{2,2} \end{bmatrix}$$

is said to be *bsymmetric* if all blocks are symmetric matrices, $A_{1,1} = A_{2,2}$ and $A_{1,2} = A_{2,1}$. Clearly, the class of bsymmetric matrices of dimension k constitute a subalgebra of the algebra of symmetric matrices which is denoted by \mathcal{BS}_k . In this setting \mathcal{BS} refers to the whole class of bsymmetric matrices.

Moreover, let us recall a standard determinant identity for block matrices as follows;

$$\det \begin{bmatrix} A_{1,1} & A_{1,2} \\ A_{2,1} & A_{2,2} \end{bmatrix} = \det(A_{1,1} - A_{1,2}A_{2,2}^{-1}A_{2,1}) \det(A_{2,2}),$$

whenever $A_{2,2}$ is an invertible matrix.

2 Cylindrical constructs and their spectra

Cylindrical constructs and their dual are introduced in [5] (also see [11] and references therein) as a general edge-replacement graph construction unifying many well-known constructions so far and introducing a couple of new ones which deserve closer study.

In this article we will only be dealing with cylindrical constructions which are built on simple graphs using symmetric cylinders, where our major focus is on the linear algebra behind this construction. Hence, we disregard the definition of the construction in its most general form as it is available in [5] for the interested reader to refer to, while we provide an equivalent definition of the same concept in the special case appearing in this article which is in terms of the corresponding adjacency matrices of the base-graph and the matrices assigned to the corresponding cylinders. This approach is definitely more convenient for our linear-algebraic study and also will make our comparison to other matrix operations as tensor products etc. easier.

2.1 Symmetric cylinders and their corresponding matrices

Since, in this article, we will only be dealing with bsymmetric cylinders with non-intersecting bases (see [5] for the definition in a general case), in what follows a

cylinder H will be a simple graph,

- along with two disjoint and isomorphic vertex-labeled subgraphs

$$B = (V(B) = \{b_0, b_1, \dots, b_\ell\}, E(B))$$

and

$$B' = (V(B') = \{b'_0, b'_1, \dots, b'_\ell\}, E(B'))$$

for some integer $\ell \geq 0$, called bases,

- and an automorphism $\sigma \in \text{Aut}(H)$ such that
 - a) We have $\sigma(B) = B'$ and $\sigma(B') = B$,
 - b) For every $1 \leq i \leq \ell$ we have $\sigma(b_i) = b'_i$ and $\sigma(b'_i) = b_i$.

Vertices that do not appear in $V(B \cup B')$ are called *inner-vertices*, and clearly, by the symmetry of the concept, at times, bases may not be distinguished in our arguments below. Based on this definition, in what follows, we refer to a cylinder H as $H = (B, C)$, where B is the base subgraph and C is the subgraph induced on the inner-vertices. In this setting, the adjacency matrix of a cylinder $H = (B, C)$ is referred to as the following block matrix,

$$H = \begin{array}{c} \\ B \\ B' \\ C \end{array} \begin{array}{ccc} B & B' & C \\ \left[\begin{array}{ccc} B & E^{bb'} & E^{bc} \\ (E^{bb'})^* & B & E^{b'c} \\ (E^{bc})^* & (E^{b'c})^* & C \end{array} \right] \end{array}.$$

Note that the set of inner-vertices may be empty in which case the corresponding rows and columns are excluded from the adjacency matrix. Also, in this setup, B and B' refer to the subgraphs induced on the bases, respectively, and the blocks of the matrix H refer to the corresponding adjacency structures.

Clearly, if Σ is the permutation matrix corresponding to the automorphism σ partitioned as the following block matrix,

$$\Sigma = \begin{bmatrix} 0 & I & 0 \\ I & 0 & 0 \\ 0 & 0 & P \end{bmatrix},$$

then by the equality $\Sigma H \Sigma^* = H$ we have

$$E^{bb'} = (E^{bb'})^*, E^{b'c} = E^{bc} P, E^{bc} = E^{b'c} P \text{ and } PC = CP.$$

Example 1. A couple of symmetric cylinders

In this example we review some very basic bsymmetric cylinders. To start, consider the path cylinder P_{k+2} depicted in Figure 1 whose bases are isomorphic to K_1 and and the subgraph induced on the inner-vertices C is isomorphic to P_k . Clearly, a cylindrical construction using this bsymmetric cylinder gives rise to the

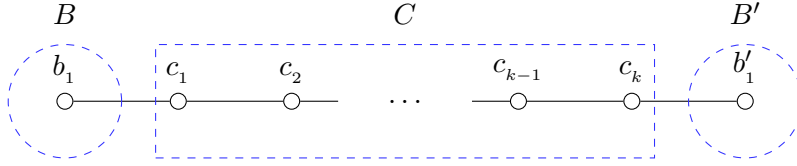

Figure 1: The path cylinder P_{k+2} (see Example 2).

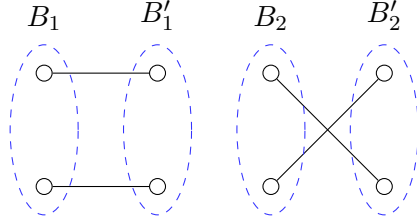

Figure 2: The identity cylinder and its twist related to random 2-lifts (see [12]).

well-known subdivision construction. Explicitly, in this case, for $k \geq 1$, we have $E^{bb'} = 0$, $E^{bc} = [1 \ 0 \ \cdots \ 0]_{1 \times k}$ and $E^{b'c} = [0 \ \cdots \ 0 \ 1]_{1 \times k}$.

On the other hand, consider the identity cylinder and its twist depicted in Figure 2. Based on a breakthrough of Marcus, Spielman and Srivastava [12] a random choice of these cylinders in a cylindrical construct gives rise to regular Ramanujan graphs of arbitrary degree. Note that these pair of cylinders constitute a coherent set of bsymmetric cylinders for which we have $E_1^{bb'} = I$, $E_2^{bb'} = \bar{I}$ (for the definition see [5, 11] or the paragraph preceding the next proposition).

As the third example, consider the π -cylinders \square and \sqcup (see Figure 3) that clearly form a coherent set of bsymmetric cylinders. The main point of using these cylinders is that they can be used to sparsify dense regular graphs of even degree. This as a special case of tree-cylinders will be discussed in Section 3 in more detail (see [11]).

Note that for these cylinders we have $E_1^{bb'} = \begin{bmatrix} 0 & 0 \\ 0 & 1 \end{bmatrix}$ and $E_2^{bb'} = \begin{bmatrix} 1 & 0 \\ 0 & 0 \end{bmatrix}$.

◆

Proposition 1. *Given a bsymmetric cylinder $H = (B, C)$, the following two statements hold and are equivalent.*

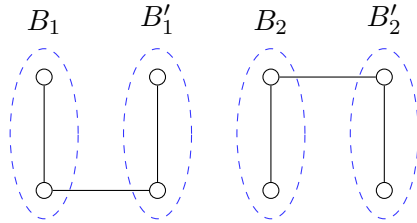

Figure 3: The π -cylinders (see [5]).

a) For every integer $k \geq 0$ we have

$$\begin{bmatrix} E^{bc} \\ E^{b'c} \end{bmatrix} C^k \begin{bmatrix} (E^{bc})^* & (E^{b'c})^* \end{bmatrix} = \begin{bmatrix} E^{bc} C^k (E^{bc})^* & E^{bc} C^k (E^{b'c})^* \\ E^{b'c} C^k (E^{bc})^* & E^{b'c} C^k (E^{b'c})^* \end{bmatrix} \in \mathcal{BS}.$$

b) For every $x \in \mathbb{R}$ which is not an eigenvalue of C we have

$$\begin{bmatrix} E^{bc} \\ E^{b'c} \end{bmatrix} (xI - C)^{-1} \begin{bmatrix} (E^{bc})^* & (E^{b'c})^* \end{bmatrix} \stackrel{\text{def}}{=} \begin{bmatrix} R_d(C) & R_a(C) \\ R_a(C) & R_d(C) \end{bmatrix} \in \mathcal{BS},$$

where $R_d(C_i)$ and $R_a(C_i)$ are rational functions of x .

Proof. For Part (a), fix $k \geq 0$ and first note that using the setup preceding Example 1 we have,

$$\begin{aligned} E^{b'c} C^k (E^{b'c})^* &= E^{bc} P C^k P^* (E^{bc})^* \\ &= E^{bc} C^k (E^{bc})^*. \end{aligned}$$

On the other hand,

$$\begin{aligned} E^{bc} C^k (E^{bc})^* &= E^{bc} C^k P^* (E^{bc})^* \\ &= E^{bc} P^* C^k (E^{bc})^* \\ &= E^{b'c} C^k (E^{b'c})^*. \end{aligned}$$

For Part (b) note that the resolvent $(xI - C)^{-1}$ can be expressed in terms of powers of $(xI - C)$ as a polynomial by Cayley-Hamilton theorem, which itself can be expressed in terms of powers of C . Hence, Part (b) holds as a consequence of Part (a).

Moreover, one may note that

$$Y(X) \stackrel{\text{def}}{=} \begin{bmatrix} E^{bc} \\ E^{b'c} \end{bmatrix} X^k \begin{bmatrix} (E^{bc})^* & (E^{b'c})^* \end{bmatrix}$$

is a continuous linear operator, hence, using Dunford-Taylor integral representation (e.g. [14]) for the k th power operator one gets (a). ■

It is important to note that for any bsymmetric cylinder $H = (B, C)$, by Proposition 1, essentially

$$\begin{bmatrix} E^{bc} \\ E^{b'c} \end{bmatrix} f(C) \begin{bmatrix} (E^{bc})^* & (E^{b'c})^* \end{bmatrix} \in \mathcal{BS}$$

for any holomorphic function f .

Recall that given $t \geq 1$, a *coherent* list of cylinders $\mathcal{H} = (H_0, \dots, H_{t-1})$ is an ordered list of t (not necessarily disjoint) cylinders $H_i = (B, C_i)$ for $0 \leq i < t$, meaning that all cylinders have isomorphic bases (see [5, 11] for more details).

Now, given a graph G which is decomposed into k edge-disjoint spanning subgraphs $\mathcal{G} = (G_0, \dots, G_{t-1})$ each of which has no isolated vertex, along with a coherent set of cylinders $\mathcal{H} = (H_0, \dots, H_{t-1})$, one may talk about the cylindrical construction $\mathcal{G} \boxtimes \mathcal{H}$, which is the graph constructed by replacing each edge of G_i by the corresponding cylinder H_i for all $0 \leq i < t$ and then identifying the bases of cylinders corresponding to each vertex of G . Then it is not difficult to verify that the adjacency matrix of $\mathcal{G} \boxtimes \mathcal{H}$, denoted by $A(\mathcal{G} \boxtimes \mathcal{H})$, can be organized as the following block matrix,

$$A(\mathcal{G} \boxtimes \mathcal{H}) = \left[\begin{array}{c|ccc} I \otimes B + \sum_{i=0}^{t-1} (G_i \otimes E_i^{bb'}) & M_0 & \cdots & M_{t-1} \\ \hline (M_0)^* & I \otimes C_0 & & 0 \\ \vdots & & \ddots & \\ (M_{t-1})^* & 0 & & I \otimes C_{t-1} \end{array} \right].$$

2.2 The main spectral theorem

Definition 1. For $t \geq 1$, a *commutative t -decomposition* of a graph G is a family of t edge-disjoint spanning subgraphs of G , as (G_0, \dots, G_{t-1}) each of which has no isolated vertex such that for every pair of disjoint indices i and j , the matrices G_i and G_j commute, and moreover, $G = \sum_{i=0}^{t-1} G_i$.

For any such commutative t -decomposition, a numbering of the spectrum of each component G_i as θ_i^j for $0 \leq i < t$ and $1 \leq j \leq n$, is said to be a *compatible* numbering of eigenvalues if there exists a unitary matrix U such that the (j, j) entry of the diagonal matrix UG_iU^{-1} is θ_i^j . \blacktriangle

Given an integer $n \geq 3$ and t mutually distinct positive integers k_0, \dots, k_{t-1} with $1 \leq k_i < n/2$ for $0 \leq i < t$, let $C_n(k_0, \dots, k_{t-1})$ be the Cayley graph defined on the vertex set $\{0, 1, \dots, n-1\}$ and with the edge set $\cup_{i=0}^{t-1} E_i$ where

$$E_i \stackrel{\text{def}}{=} \{uv \mid v = u + k_i \pmod{n}\}.$$

In this setting, $C_n(k_i)$ stands for the subgraph on the edge set E_i .

Now, as a very basic and important example of a compatible numbering of eigenvalues, let U_F be the Fourier $n \times n$ matrix whose (r, s) entry is equal to $\frac{1}{\sqrt{n}} \zeta_n^{r \times s}$ where ζ_n is the n th root of unity, $\exp(\frac{2\pi i}{n})$. Then note that, $U_F C_n(k) U_F^{-1}$ is a diagonal matrix with (r, r) entry equal to $2 \cos(2\pi r k/n)$. Hence, $\theta_i^j \stackrel{\text{def}}{=} 2 \cos(2\pi j k_i/n)$ is a compatible numbering for the eigenvalues of the decomposition

$$(C_n(k_0), C_n(k_1), \dots, C_n(k_{t-1})).$$

The following theorem links the fundamental subjects, *graph decompositions* and *graph spectra* in a general setup, making it possible to use results on graph decompositions to construct graphs with prescribed properties for their spectra on the one hand, and motivate interesting decomposition problems to be investigated in forthcoming research, on the other (also see Section 4).

Theorem 1. Given $t \geq 1$, let $\mathcal{G} = (G_0, \dots, G_{t-1})$ be a commutative t -decomposition of G on n vertices with $|E(G_i)| = m_i$ and let θ_i^j be a compatible numbering of its eigenvalues. Also, assume that $\mathcal{H} = (H_0, \dots, H_{t-1})$ is an ordered list of coherent bsymmetric cylinders with base B . Then

$$\phi(\mathcal{G} \boxtimes \mathcal{H}, x) = \left(\prod_{i=0}^{t-1} \phi(C_i, x)^{m_i} \right) \det \left(I_n \otimes (xI - B) - \sum_{i=0}^{t-1} \left(G_i \otimes (E_i^{bb'} + R_a(C_i)) + D_i \otimes R_d(C_i) \right) \right)$$

where D_i is the diagonal matrix of degrees of G_i . In particular,

a) If each G_i is a d_i -regular graph, then

$$\phi(\mathcal{G} \boxtimes \mathcal{H}, x) = \left(\prod_{i=0}^{t-1} \phi(C_i, x)^{m_i} \right) \prod_{j=1}^n \phi \left(B + \sum_{i=0}^{t-1} (d_i R_d(C_i) + \theta_i^j (E_i^{bb'} + R_a(C_i))), x \right).$$

b) If each H_i has no inner-vertex, then

$$\phi(\mathcal{G} \boxtimes \mathcal{H}, x) = \prod_{j=1}^n \phi \left(B + \sum_{i=0}^{t-1} \theta_i^j E_i^{bb'}, x \right).$$

Specifically, if also the base B of each H_i is an empty graph, then we have the following generalized tensor product,

$$\phi(\mathcal{G} \boxtimes \mathcal{H}, x) = \prod_{j=1}^n \phi \left(\sum_{i=0}^{t-1} \theta_i^j E_i^{bb'}, x \right).$$

Proof. Clearly, we have

$$\mathcal{G} \boxtimes \mathcal{H} \stackrel{\text{def}}{=} \left[\begin{array}{c|ccc} I_n \otimes B + \sum_{i=0}^{t-1} (G_i \otimes E_i^{bb'}) & M_0 & \cdots & M_{t-1} \\ \hline (M_0)^* & I_{m_1} \otimes C_0 & & 0 \\ \vdots & & \ddots & \\ (M_{t-1})^* & 0 & & I_{m_k} \otimes C_{t-1} \end{array} \right].$$

In what follows, we prove identities for the characteristic polynomial of $\mathcal{G} \boxtimes \mathcal{H}$ when the variable x is a real number outside of the spectra of C_i 's. Note that this is sufficient to show that the characteristic identities actually hold for all real numbers $x \in \mathbb{R}$ since two polynomials of variable x are identical if they are equal for all but a finite number of values for x .

Using determinant rule for block matrices, we have

$$\phi(\mathcal{G} \boxtimes \mathcal{H}, x) = \left(\prod_{i=0}^{t-1} \det(xI - C_i)^{m_i} \right) \det \left(I \otimes (xI - B) - \sum_{i=0}^{t-1} (G_i \otimes E_i^{bb'} + M_i (I_{m_i} \otimes (xI - C_i))^{-1} M_i^*) \right),$$

and consequently,

$$\phi(\mathcal{G} \boxtimes \mathcal{H}, x) = \left(\prod_{i=0}^{t-1} \det(xI - C_i)^{m_i} \right) \det \left(I \otimes (xI - B) - \sum_{i=0}^{t-1} (G_i \otimes E_i^{bb'} + \sum_{j=1}^{m_i} (M_{ij} (xI - C_i)^{-1} M_{ij}^*)) \right),$$

where M_{ij} is the column of M_i corresponding to the j th edge of G_i , with only two non-zero blocks equal to $E_i^{bc}, E_i^{b'c}$ corresponding to the two ends of the j th edge.

Note that, $M_{ij}(xI - C_i)^{-1}M_{ij}^*$ is an $n \times n$ block matrix with four non-zero block, two of which are two diagonal blocks corresponding to the two ends of the j th edge equal to $R_d(C_i)$ and two other blocks corresponding to the two entries of the j th edge in the adjacency matrix of G_i equal to $R_a(C_i)$. Now, using Proposition 1 we have

$$\phi(\mathcal{G} \boxtimes \mathcal{H}, x) = \left(\prod_{i=0}^{t-1} \det(xI - C_i)^{m_i} \det(I \otimes (xI - B) - \sum_{i=0}^{t-1} (G_i \otimes (E_i^{bb'} + R_a(C_i)) + D_i \otimes R_d(C_i))) \right).$$

Since G_i 's are symmetric matrices that commute with each other, they are simultaneously diagonalizable by a unitary matrix U . Let $\theta_i^1, \dots, \theta_i^n$ be the corresponding compatible numbering of eigenvalues of G_i 's, i.e. for every $0 \leq i < t$ we have

$$UG_iU^{-1} = \begin{pmatrix} \theta_i^1 & 0 & \cdots & 0 \\ 0 & \theta_i^2 & \cdots & 0 \\ \vdots & & \ddots & \vdots \\ 0 & 0 & \cdots & \theta_i^n \end{pmatrix}.$$

Now, if each G_i is a d_i -regular graph, then

$$\begin{aligned} \phi(\mathcal{G} \boxtimes \mathcal{H}, x) &= \left(\prod_{i=0}^{t-1} \det(xI - C_i)^{m_i} \det(I \otimes (xI - B - \sum_{i=0}^{t-1} d_i R_d(C_i)) - \sum_{i=0}^{t-1} (UG_iU^{-1} \otimes (E_i^{bb'} + R_a(C_i))) \right) \\ &= \left(\prod_{i=0}^{t-1} \det(xI - C_i)^{m_i} \det(I \otimes (xI - B - \sum_{i=0}^{t-1} d_i R_d(C_i)) \right. \\ &\quad \left. - \sum_{i=0}^{t-1} \begin{bmatrix} \theta_i^1(E_i^{bb'} + R_a(C_i)) & 0 & \cdots & 0 \\ 0 & \theta_i^2(E_i^{bb'} + R_a(C_i)) & \cdots & 0 \\ \vdots & & \ddots & \vdots \\ 0 & 0 & \cdots & \theta_i^n(E_i^{bb'} + R_a(C_i)) \end{bmatrix} \right) \\ &= \left(\prod_{i=0}^{t-1} \det(xI - C_i)^{m_i} \times \right. \\ &\quad \left. \det \begin{bmatrix} xI - B - \sum_{i=0}^{t-1} (d_i R_d(C_i) + \theta_i^1(E_i^{bb'} + R_a(C_i))) & \cdots & 0 \\ \vdots & \ddots & \vdots \\ 0 & \cdots & xI - B - \sum_{i=0}^{t-1} (d_i R_d(C_i) + \theta_i^n(E_i^{bb'} + R_a(C_i))) \end{bmatrix} \right) \end{aligned}$$

Hence,

$$\phi(\mathcal{G} \boxtimes \mathcal{H}, x) = \left(\prod_{i=0}^{t-1} \det(xI - C_i)^{m_i} \prod_{j=1}^n \det(xI - B - \sum_{i=0}^{t-1} (d_i R_d(C_i) + \theta_i^j(E_i^{bb'} + R_a(C_i))) \right).$$

Part (b) follows directly from the main equality above. ■

It is instructive to go through a couple of remarks on some special cases (see [5, 11] for the necessary background).

First, note that the identity cylinder is clearly bsymmetric and the corresponding cylindrical construction is identical to the tensor product of matrices. Hence, Part (b)'s reference to tensor products is justified.

On the other hand, it is known that a large number of graph products are essentially symmetric cylindrical constructs. In particular, one may refer to the NEPS or the lexicographic products of graphs. Hence, Theorem 1 rediscovers a number of previously known results for such constructs.

It is interesting to recall that the Petersen graph is actually a cylindrical construct on the complete graph on five vertices using the coherent set of cylinders $\{\square, \sqcup\}$ (see [5, 11]). But noting that K_5 can be decomposed into two commuting five-cycles, one may apply Theorem 1 to compute the spectrum. This scenario is worked out in detail for the more general case of generalized GI-graphs in Example 3.

Example 2. Spectrum of a subdivision [13]

In this example we rediscover a result of V. B. Menuhin [13] on the spectrum of the k th subdivision of a graph G which is clearly isomorphic to $G \boxtimes P_{k+2}$. Note that in this case, the cylinder P_{k+2} is clearly bsymmetric (see Figure 1) and we have $B = K_1$ and $C = P_k$. Hence, one may verify that

$$R_d(P_k) = \frac{U_{k-1}(x/2)}{U_k(x/2)}, \quad R_a(P_k) = \frac{1}{U_k(x/2)} \quad \text{and} \quad E^{bb'} = 0,$$

in which $U_k(x)$ is the Chebyshev polynomial of the second kind. Therefore, using Theorem 1 we have,

$$\begin{aligned} \phi(G \boxtimes P_{k+2}, x) &= \phi(P_k, x)^{|E(G)|} \phi(G \otimes R_a(P_k) + D \otimes R_d(P_k), x) \\ &= (U_k(x/2))^{|E(G)|} \phi(R_a(P_k)G + R_d(P_k)D, x) \\ &= (U_k(x/2))^{|E(G)|-n} \phi(G + U_{k-1}(x/2)D, xU_k(x/2)). \end{aligned}$$

In particular, if G is a d -regular graph, then

$$\begin{aligned} \phi(G \boxtimes P_{k+2}, x) &= (U_k(x/2))^{|E(G)|} \phi\left(G, x - d \frac{U_{k-1}(x/2)}{U_k(x/2)}\right) \\ &= (U_k(x/2))^{|E(G)|-n} \phi(G, xU_k(x/2) - dU_{k-1}(x/2)). \end{aligned}$$

◆

Example 3. Spectra of GI-graphs [4]

Let $\square_{t,i}$ be the bsymmetric cylinder whose bases are isomorphic to K_t on the vertex set $\{b_0, b_1, \dots, b_{t-1}\}$ in which there is only one edge joining the i th vertices b_i 's of the two bases (see Figure 4). In this setting note that $\mathcal{H} \stackrel{\text{def}}{=} \{\square_{t,0}, \dots, \square_{t,t-1}\}$ form a coherent set of bsymmetric cylinders.

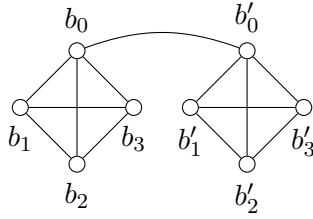

Figure 4: The cylinder $\Pi_{4,0}$.

Now, given a positive integer $n > 0$ and t positive and distinct integers k_0, \dots, k_{t-1} each less than $n/2$, the *generalized I-graph* $\text{GI}(n; k_0, \dots, k_{t-1})$ is the cylindrical construct

$$\text{GI}(n; k_0, \dots, k_{t-1}) \stackrel{\text{def}}{=} C_n(k_0, \dots, k_{t-1}) \boxtimes \mathcal{H},$$

in which the cylinder $\Pi_{t,i}$ is assigned to the edge set E_i .

First, note that, it is not hard to verify that this definition is equivalent to the original definition introduced in [4]. On the other hand, it must be mentioned that the special case for which t is equal to 2 gives rise to the definition of I-graphs [3] and when $t = k_0 = 2$ we have the well-known generalized Petersen graphs [7, 16].

In what follows, we rediscover the characteristic polynomial and the spectra of generalized I-graphs using Theorem 1.

One may verify that the subgraphs $C_n(k_i)$ for $0 \leq i < t$ constitute a commutative t -decomposition of $C_n(k_0, \dots, k_{t-1})$, and consequently, Theorem 1 can be applied. Noting that $\theta_i^j = 2 \cos(2jk_i \pi/n)$, $B = J - I$, and moreover $E_i^{bb'}$ is a matrix with all entries equal to zero except the (i, i) entry which is equal to one, we have

$$\phi(\text{GI}(n; k_0, \dots, k_{t-1}), x) = \prod_{j=1}^n \phi\left(J - I + \sum_{i=0}^{t-1} 2 \cos(2jk_i \pi/n) E_i^{bb'}\right).$$

Also, focusing on the special case of I-graphs one gets,

$$\phi(\text{I}(n; k, \ell), x) = \prod_{j=1}^n (x^2 - (2 \cos(2jk\pi/n) + 2 \cos(2j\ell\pi/n))x + (4 \cos(2jk\pi/n) \cos(2j\ell\pi/n) - 1)).$$

and moreover for $j = 1, \dots, n$ the eigenvalues are as follows,

$$(\cos(2jk\pi/n) + \cos(2j\ell\pi/n)) \pm \sqrt{(\cos(2jk\pi/n) - \cos(2j\ell\pi/n))^2 + 1}.$$

◆

Using notations of Example 3, $\Pi_{2,0}$ and $\Pi_{2,1}$ are referred to as π -cylinders. The most basic application of π -cylinders is their use to construct the celebrated Petersen graph (see Example 3 and [5, 11] for more on this).

Example 4. On the role of internal vertices

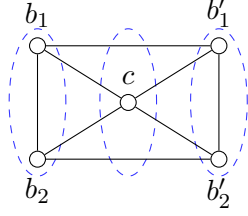

Figure 5: See Example 4.

In this example we explore the role of inner-vertices on the spectrum of the cylindrical construction. As a very simple example consider the bsymmetric cylinder H depicted in Figure 5, for which one may easily verify that $B = \bar{I}$ and $R_d(C) = R_a(C) = \frac{1}{x}J$.

Now if G is a d -regular graph on n vertices, then using Theorem 1 we have,

$$\begin{aligned}
\phi(\mathcal{G} \boxtimes H, x) &= x^{nd/2} \prod_{j=1}^n \phi\left(\bar{I} + \frac{d}{x}J + \theta^j\left(I + \frac{1}{x}J\right), x\right) \\
&= x^{n(d-2)/2} \prod_{j=1}^n \phi\left(x\bar{I} + dJ + \theta^j(xI + J), x^2\right) \\
&= x^{n(d-2)/2} \prod_{j=1}^n \det\left(\begin{bmatrix} x^2 - d - \theta^j(x+1) & -x - d - \theta^j \\ -x - d - \theta^j & x^2 - d - \theta^j(x+1) \end{bmatrix}\right) \\
&= x^{n(d-2)/2} \prod_{j=1}^n x(x - (\theta^j - 1)(x^2 - (\theta^j + 1)x - 2(\theta^j + d))).
\end{aligned}$$

Therefore, $\mathcal{G} \boxtimes H$ has zero eigenvalues coming from the internal subgraph of the cylinder along with $2n$ other eigenvalues as follows,

$$(0)^{nd/2}, \left\{ (\theta^j - 1), \left(\frac{(\theta^j + 1) \pm \sqrt{(\theta^j + 1)^2 + 8(\theta^j + d)}}{2} \right) \right\}_{1 \leq j \leq n}.$$

This also can be true for the general case using Theorem 1 when one notes that eigenvalues of the internal subgraph of the cylinder passes to the spectrum of the cylindrical construct when the number of edges of the base-graph G is larger than the number of its vertices. \blacklozenge

3 Sparsification by tree-cylinders

Strictly speaking, for cylinders with no inner-vertices, Theorem 1 reduces the problem of computing the eigenvalues of the cylindrical construct to computing the spectrum of a perturbation of the base of the cylinders.

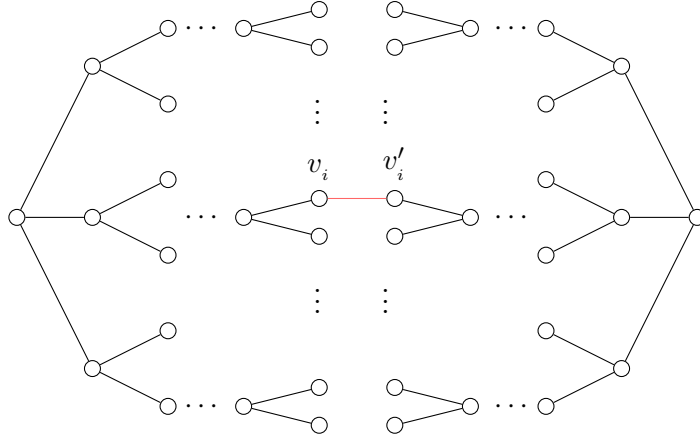

Figure 6: The graph $T_{3,h,i}^\bullet$ (See Definition 2).

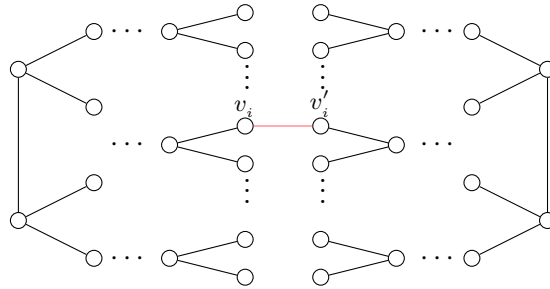

Figure 7: The graph $\bar{T}_{3,h,i}$ (See Definition 2).

On the other hand, as far as finding extremely connected graphs (e.g. say Ramanujan graphs) are concerned, one should concentrate on cylindrical constructions that are capable of reducing the degree. For instance, applications such as Example 3 shows such properties (also see [5, 11]). In this scenario, using such degree-reduction cylindrical processes, one may start from a highly connected graph (e.g. a complete graph) and apply iterative degree reductions to find highly connected graphs of smaller degree. Clearly, the main question in this setting is to estimate the rate at which the cylindrical construction expands the spectrum.

Tree cylinders are introduced in [11] as examples of cylinders that may be used in such degree reduction procedures. Hence, in this section we are going to delve a bit more into the spectral properties of such constructs.

Definition 2. Tree cylinders [11]

A *tree-cylinder* in general is a cylinder whose bases are identical vertex-labeled copies of a tree for which there exists only a unique edge joining one leaf of the right base to another leaf of the left one. In what follows we will only be dealing with bsymmetric regular tree-cylinders, $T_{k,h,i}^\bullet$ and $\bar{T}_{k,h,i}$ defined as,

- $T_{k,h,i}^\bullet$: For $0 \leq i < k \times (k-1)^{h-1}$, $T_{k,h,i}^\bullet$, is a cylinder whose bases are identical copies of the *complete rooted* k -regular tree $T_{k,h}^\bullet$ of height h in which the leaves are numbered consecutively and there is only one edge joining the i th leaves of both bases (see Figure 6).
- $\bar{T}_{k,h,i}$: For $0 \leq i < 2(k-1)^h$, $\bar{T}_{k,h,i}$, is a cylinder whose bases are identical copies of the *complete unrooted* k -regular tree $\bar{T}_{k,h}$ of height h in which the leaves are numbered consecutively and there is only one edge joining the i th leaves of both bases (see Figure 7).

Note that, by definition, both $T_{k,h,i}^\bullet$ and $\bar{T}_{k,h,i}$ are bsymmetric cylinders. As shown in [11], tree-cylinders can be used as sparsifiers, in the sense that they can be used in a cylindrical construction that reduces the degree and increases the girth of the base graph. \blacktriangle

Hereafter, we always assume that the corresponding adjacency matrices $T_{k,h}^\bullet$ and $\bar{T}_{k,h}$ are formed based on the numbering for which there is a priority for lower levels and at each level the vertices appear consecutively from left to the right. Note that in this setting the adjacency matrix $T_{k,h}^\bullet$ can also be defined recursively as

$$T_{k,h}^\bullet = \begin{bmatrix} T_{k,h-1}^\bullet & C_h \\ C_h^* & 0 \end{bmatrix},$$

in which C_h is the adjacency submatrix corresponding to the leaves of $T_{k,h}^\bullet$. Clearly, there is a similar recursive formula for $\bar{T}_{k,h}$ too.

Since in what follows we will be needing to refer to some special cyclic decompositions of complete graphs, let us consider a complete graph K_n on the vertex set $V(K_n) \stackrel{\text{def}}{=} \{0, 1, \dots, n-1\}$ along with its spanning subgraphs $C_n(k)$ already defined in Example 3. Note that if n and k are relatively prime integers, then $C_n(k)$ is a cycle. Also, if $n > 2$ is a prime integer, then the set containing $t = \frac{n-1}{2}$ of such subgraphs for different values of $1 \leq k \leq t$, constitute a commutative t -decomposition of K_n .

Definition 3. tree-mixing

Consider T , a 3-regular tree of height h , and assume that we have assigned extra labels $a_i \in \mathbb{F}[x]$ for the i th leaf at the h th level for $0 \leq i \leq \Lambda_h - 1$, where Λ_ℓ is the number of vertices at the ℓ th level. A *tree mixing* of the ordered list $(a_0, a_1, \dots, a_{\Lambda_h-1})$ is a recursive process of assigning labels in $\mathbb{F}(x)$ (the field of rational fractions of $\mathbb{F}[x]$) to the vertices of T starting from the leaves towards the root, in such a way that the label assigned to the vertex v whose siblings have labels b and c is equal to $x - (b^{-1} + c^{-1})$ (note that for a rooted tree T , the label assigned to the root v is equal to $x - (b^{-1} + c^{-1} + d^{-1})$ where the siblings of v have labels b , c and d). In this setting, the product of the labels of vertices at each level $0 \leq \ell \leq h$ is called the *resultant* of that level denoted by $R_T(\ell)$, and the product of resultants of all levels,

$$R(T) \stackrel{\text{def}}{=} \prod_{\ell=0}^h R_T(\ell),$$

is defined to be the *resultant* of the labeled tree $\Gamma(a_0, a_1, \dots, a_{\Lambda_h - 1})$ itself as the final result of the tree-mixing. \blacktriangle

Now, let us concentrate on an application of Theorem 1 for a very special case using tree-cylinders to generate sparse 3-regular graphs, which also can be considered as a variant of Example 3. A byproduct of the following proof is the fact that in some special cases the resultant of a tree-mixing is actually a polynomial in $\mathbb{F}[x]$.

Proposition 2.

Given integers n, t and $1 \leq k_i \leq \frac{n-1}{2}$ for $0 \leq i < t$, fix $\mathcal{C} \stackrel{\text{def}}{=} (C_n(k_0), \dots, C_n(k_{t-1}))$ as a t -decomposition of $C_n(k_0, \dots, k_{t-1})$.

- a) Let $h \geq 1$ be an integer, $t = 2^{h+1}$, and $\overline{\mathcal{H}} \stackrel{\text{def}}{=} (\overline{T}_{3,h,0}, \overline{T}_{3,h,1}, \dots, \overline{T}_{3,h,t-1})$. If $\overline{\Theta}_j$ is a diagonal matrix whose diagonal entries are zero for any vertex which is not a leaf and is equal to $2 \cos \frac{2\pi j k_i}{n}$ for the i th leaf, then

$$\phi(C \boxtimes \overline{\mathcal{H}}, x) = \prod_{j=1}^n \phi(\overline{T}_{3,h} + \overline{\Theta}_j, x) = \prod_{j=1}^n R(\overline{T}_{3,h}^j) \frac{R_{\overline{T}_{3,h}}^j(0) - 1}{R_{\overline{T}_{3,h}}^j(0)}$$

in which $\overline{T}_{3,h}^j$ is an unrooted binary labeled tree (see Definition 2) whose i th leaf is labeled by $\left(x - 2 \cos \frac{2\pi j k_i}{n}\right)$.

- b) Let $h \geq 1$ be an integer, $t = 3 \times 2^{h-1}$, and $\mathcal{H}^\bullet \stackrel{\text{def}}{=} (T_{3,h,0}^\bullet, T_{3,h,1}^\bullet, \dots, T_{3,h,t-1}^\bullet)$. If Θ_j^\bullet is a diagonal matrix whose diagonal entries are zero for any vertex which is not a leaf and is equal to $2 \cos \frac{2\pi j k_i}{n}$ for the i th leaf, then

$$\phi(C \boxtimes \mathcal{H}^\bullet, x) = \prod_{j=1}^n \phi(T_{3,h}^\bullet + \Theta_j^\bullet, x) = \prod_{j=1}^n R(T_{3,h}^{\bullet j})$$

in which $T_{3,h}^{\bullet j}$ is a rooted binary labeled tree (see Definition 2) whose i th leaf is labeled by $\left(x - 2 \cos \frac{2\pi j k_i}{n}\right)$.

Proof. The proof is essentially a consequence of Theorem 1(b) along with the following fact on the existence of a recursive procedure to compute the target determinant which is equal to tree-mixing. To see this, let T_h be a binary tree of height h and consider the following target determinant for a diagonal matrix Θ_j ,

$$\det(xI - (T_h + \Theta_j)) = \det \begin{bmatrix} xI - T_{h-1} & C_h \\ C_h^* & xI - \Theta_j \end{bmatrix},$$

which is equivalent to

$$\det(xI - \Theta_j) \det(xI - T_{h-1} - C_h(xI - \Theta_j)^{-1} C_h^*),$$

assuming that x is not in the spectrum of Θ_j . Then, it is not hard to verify that $C_h(xI - \Theta_j)^{-1}C_h^*$ is also a diagonal matrix whose diagonal entries are the sum of two consecutive entries of $(xI - \Theta_j)^{-1}$. This, clearly, shows that the recursive procedure matches the tree-mixing process for the initial state labeling by the diagonal of $xI - \Theta_j$ where the only difference for cases (a) and (b) lies in the last stage.

Note that using this recursion one ends up with a polynomial which is equivalent to the characteristic polynomial of the cylindrical construct outside of a set of finite size. This, implies that the polynomial is, actually, the characteristic polynomial itself. \blacksquare

In the next proposition the n th term is explained in more detail, where the parts of the methods are borrowed from a similar study in [9].

Proposition 3.

Let $p_n(x)$ be a sequence of polynomials which are defined recursively as,

$$p_0(x) = 1, p_1(x) = x - 2, \text{ and } p_{n+2}(x) = xp_{n+1}(x) - 2p_n(x).$$

Then,

a) We have

$$p_n(x) = \frac{1}{2(\alpha - \beta)} \left(\frac{1}{\beta^{n+1}} - \frac{1}{\alpha^{n+1}} - 2 \left(\frac{1}{\beta^n} - \frac{1}{\alpha^n} \right) \right)$$

in which α and β are the roots of $1 - xt + 2t^2 = 0$ defined as

$$\alpha = \frac{x + \sqrt{x^2 - 8}}{4}, \quad \beta = \frac{x - \sqrt{x^2 - 8}}{4}.$$

b) The set $\{p_n(x)\}_{n>1}$ constitute a family of orthogonal polynomials. Roots of $p_{n-1}(x)$ interlaces those of $p_n(x)$ for $n > 1$, and moreover, if

$$\mu_1^n \geq \mu_2^n \geq \dots \geq \mu_n^n$$

are roots of $p_n(x)$ and we define $\eta_j^{n-1} = 2 \cos\left(\frac{j\pi}{n}\right)$, for $j = 1, 2, \dots, n-1$, then

$$\mu_1^n \geq \eta_1^{n-1} \geq \mu_2^n \geq \eta_2^{n-1} \geq \dots \geq \eta_{n-1}^{n-1} \geq \mu_n^n.$$

c) Within the setup of Proposition 2 we have

$$\phi(\overline{T}_{3,h} + \overline{\Theta}_n, x) = \left(\prod_{i=1}^h p_i(x)^{\frac{\overline{\Lambda}_{h-i+1}}{2}} \right) (p_{h+1}(x)^2 - p_h(x)^2),$$

and

$$\phi(T_{3,h}^\bullet + \Theta_n^\bullet, x) = \left(\prod_{i=1}^{h-1} p_i(x)^{\frac{\Lambda_{h-i+1}^\bullet}{2}} \right) p_h(x)^2 (xp_h(x) - 3p_{h-1}(x)),$$

where $\overline{\Lambda}_\ell$ and Λ_ℓ^\bullet are the number of vertices in ℓ th levels of $\overline{T}_{3,h}$ and $T_{3,h}^\bullet$, respectively.

Proof. To prove part (a) let $G(x, t) \stackrel{\text{def}}{=} \sum_{n=0}^{\infty} p_n(x)t^n$. Then,

$$p_{n+2}(x)t^n = xp_{n+1}(x)t^n - 2p_n(x)t^n$$

implies that

$$\frac{1}{t^2} \sum_{n=0}^{\infty} p_{n+2}(x)t^{n+2} = \frac{x}{t} \sum_{n=0}^{\infty} p_{n+1}(x)t^{n+1} - 2 \sum_{n=0}^{\infty} p_n(x)t^n$$

and consequently,

$$\frac{1}{t^2}(G(x, t) - 1 - (x - 2)t) = \frac{x}{t}(G(x, t) - 1) - 2G(x, t)$$

showing that

$$\left(\frac{1}{t^2} - \frac{x}{t} + 2\right)G(x, t) = \frac{1}{t^2} - \frac{2}{t}$$

and

$$G(x, t) = \frac{1 - 2t}{(1 - xt + 2t^2)}.$$

Now if $1 - xt + 2t^2 = 0$, then

$$\alpha = \frac{x + \sqrt{x^2 - 8}}{4}, \beta = \frac{x - \sqrt{x^2 - 8}}{4}$$

and we have,

$$G(x, t) = \frac{1 - 2t}{2(\alpha - \beta)} \left(\frac{1}{t - \alpha} - \frac{1}{t - \beta} \right).$$

Therefore,

$$G(x, t) = \frac{1 - 2t}{2(\alpha - \beta)} \left(\frac{1}{\beta} \sum_{n=0}^{\infty} \frac{t^n}{\beta^n} - \frac{1}{\alpha} \sum_{n=0}^{\infty} \frac{t^n}{\alpha^n} \right)$$

where the coefficient of t^n , $p_n(x)$, is

$$p_n(x) = \frac{1}{2(\alpha - \beta)} \left(\frac{1}{\beta^{n+1}} - \frac{1}{\alpha^{n+1}} - 2 \left(\frac{1}{\beta^n} - \frac{1}{\alpha^n} \right) \right).$$

For part (b), first note that the sequence of polynomials $\{p_n(x)\}_{n>1}$ satisfy a three-term recurrence relation, and consequently, by Favard's theorem they constitute an orthogonal sequence of polynomials for which the roots of $p_{n-1}(x)$ interlace those of $p_n(x)$ [15].

On the other hand, note that $p_n(x)$ is equal to the characteristic polynomial of the following n by n tridiagonal matrix

$$\tau(n) \stackrel{\text{def}}{=} \begin{bmatrix} 2 & 1 & & \\ & 2 & 0 & \ddots \\ & & \ddots & \ddots & 1 \\ & & & 2 & 0 \end{bmatrix}$$

which is similar to

$$\hat{\tau}(n) \stackrel{\text{def}}{=} \begin{bmatrix} 2 & \sqrt{2} & & & \\ \sqrt{2} & 0 & \ddots & & \\ & \ddots & \ddots & \sqrt{2} & \\ & & \sqrt{2} & 0 & \end{bmatrix}.$$

Hence, if we consider the principal submatrix, $\hat{\tau}_{1,1}(n)$, obtained by removing the first row and the first column, then its characteristic polynomial is equal to $(\sqrt{2})^{n-1} U_{n-1}(\frac{x}{2\sqrt{2}})$ and this implies that the eigenvalues of $\hat{\tau}_{1,1}$ are equal to $\eta_j^{n-1} = 2 \cos(\frac{j\pi}{n})$, for $j = 1, 2, \dots, n-1$. Hence, by the interlacing theorem we have

$$\mu_1^n \geq \eta_1^{n-1} \geq \mu_2^n \geq \eta_2^{n-1} \geq \dots \geq \eta_{n-1}^{n-1} \geq \mu_n^n.$$

It is also instructive to note that, as a well-known fact, the eigenvalues of a tridiagonal matrix with positive off-diagonal entries are real and simple (e.g. see [6]). Therefore, by considering the principal submatrix obtained by removing the last row and the last column, again we rediscover the fact that the roots of $p_{n-1}(x)$ interlace those of $p_n(x)$.

To prove part (c), by using part (a) of Proposition 2 we have

$$\phi(\bar{T}_{3,h} + \bar{\Theta}_n, x) = R(\bar{T}_{3,h}^n) \frac{R_{\bar{T}_{3,h}^n}(0) - 1}{R_{\bar{T}_{3,h}^n}(0)}.$$

By the definition of the resultant of labeled tree, $R(\bar{T}_{3,h}^n) = \prod_{\ell=0}^h R_{\bar{T}_{3,h}^n}(\ell)$. Note that in h th level the labels of leaves of $\bar{T}_{3,h}$ are equal to $p_1(x) = x - 2$, and hence $R_{\bar{T}_{3,h}^n}(h) = p_1(x)^{\bar{\Lambda}_h}$. The labels of vertices of $\bar{T}_{3,h}^n$ in $(h-1)$ th levels are equal to

$$x - \left(\frac{1}{p_1(x)} + \frac{1}{p_1(x)} \right) = \frac{p_2(x)}{p_1(x)},$$

and with the similar computation we obtain that the labels of vertices of $\bar{T}_{3,h}^n$ in $(h-i)$ th levels are equal $\frac{p_{i+1}(x)}{p_i(x)}$. Consequently, $R_{\bar{T}_{3,h}^n}(h-i) = \left(\frac{p_{i+1}(x)}{p_i(x)} \right)^{\bar{\Lambda}_{h-i}}$. Now, since $\bar{\Lambda}_\ell = 2\bar{\Lambda}_{\ell-1}$, we can conclude that

$$R(\bar{T}_{3,h}^n) \frac{R_{\bar{T}_{3,h}^n}(0) - 1}{R_{\bar{T}_{3,h}^n}(0)} = \left(\prod_{i=1}^h p_i(x)^{\frac{\bar{\Lambda}_{h-i+1}}{2}} \right) (p_{h+1}(x)^2 - p_h(x)^2).$$

The similar fact for the rooted tree $T_{3,h}^\bullet$ can be obtained analogously. ■

Example 5. The Coxeter cylinder

The cylinder $T_{3,1,1}^\bullet$ is defined as the Coxeter cylinder in [5, 11], the main reason being the fact that the well-known Coxeter graph can be represented as the cylindrical construction $\mathcal{K}_7 \boxtimes \mathcal{H}$ in which

$$\mathcal{H} \stackrel{\text{def}}{=} \{T_{3,1,i}^\bullet \mid 0 \leq i \leq 2\} \quad \text{and} \quad \mathcal{K}_7 \stackrel{\text{def}}{=} (C_7(1), C_7(2), C_7(3)).$$

For this case, note that by Proposition 2(b) we have $h = 1, t = 3$ and $n = 7$ where the characteristic polynomial is as follows,

$$\prod_{j=1}^7 \det \begin{bmatrix} x & -1 & -1 & -1 \\ -1 & x - 2 \cos(\frac{2\pi j}{7}) & 0 & 0 \\ -1 & 0 & x - 2 \cos(\frac{4\pi j}{7}) & 0 \\ -1 & 0 & 0 & x - 2 \cos(\frac{6\pi j}{7}) \end{bmatrix}$$

$$= (x - 3)(x - 2)^2(x + 1)((x - 2)(x + 1)(x^2 + 2x - 1))^6.$$

(For the computation, note that $2 \cos(\frac{2\pi j}{7}) = \zeta_7^j + \zeta_7^{-j}$ and that the sum of n th roots of unity is 0.)

◆

3.1 A class of highly symmetric graphs

The contents of this section is essentially a generalization of Example 5 where we introduce a class of highly symmetric graphs of type already introduced in Proposition 2 for which we have a relatively large multiplicity for the eigenvalues.

Definition 4. Cyclic group labeling of binary trees

Consider T_h , a complete binary tree of height h , of the binary monoid using concatenation, which is a labeled rooted tree with the root r (representing the word of length zero at level zero) and h levels of vertices where there are 2^ℓ vertices at the ℓ th level, and moreover, the vertices of this complete binary tree are labeled using concatenation with 0 and 1 according to a left-justified rule, where for each vertex with the label s , its left sibling has the label $s0$ and its right sibling has the label $s1$ (see Figure 8). Note that, in this way, all binary numbers of ℓ bits appear at the ℓ th level in their natural order. Hereafter, we always assume that the vertex set of a complete binary tree of height h is the set of all binary strings of length less than or equal to h , where the vertex s is a sibling of a vertex \tilde{s} if and only if $|\tilde{s}| = |s| + 1$ and s is a prefix of \tilde{s} .

Moreover, if $s = s_m \cdots s_0$ is a binary string of length $m + 1$, then its *reverse* is defined as $\hat{s} \stackrel{\text{def}}{=} s_0 \cdots s_m$ and its *corresponding integer* is defined as

$$(s)_2 \stackrel{\text{def}}{=} s_m 2^m + \cdots + s_1 2 + s_0.$$

Let $\Gamma = \langle a \mid a^N = 1 \rangle$ be a multiplicative cyclic group of order N generated by a , and let $\mathcal{C}(\Gamma)$ be the whole class of cosets of subgroups of Γ . Then, the mapping $\gamma : V(T_h) \rightarrow \mathcal{C}(\Gamma)$ defined as

$$\gamma(s) \stackrel{\text{def}}{=} a^{(\hat{s})_2} \langle a^{2^{|s|}} \rangle$$

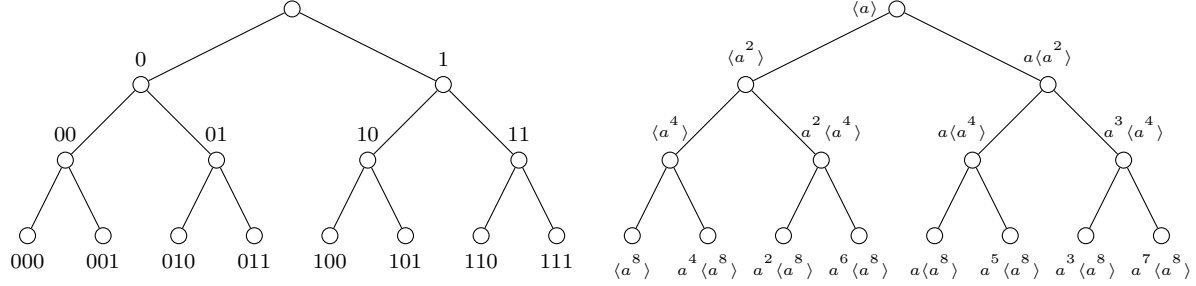

Figure 8: An example of cyclic group labeling of a binary tree T_3 by $\Gamma = \langle a \mid a^{16} = 1 \rangle$.

is called a cyclic group labeling of T_h by Γ (See Figure 8) for an example of such labeling). ▲

Example 6. Highly symmetric graphs using $\overline{T}_{3,h}$

Let $t = 2^{h+1}$ such that $n = 2t + 1$ is a prime number. Consider the multiplicative group $\Gamma = \mathbb{Z}_n^*$ of the field \mathbb{Z}_n and let a be its generator for which $a^{2t} = 1$. Also, let γ be the cyclic group labeling of a complete binary tree of height $h + 1$ by Γ and identify this labeling on $\overline{T}_{3,h}$ by just forgetting the root.

It is easy to verify that for this labeling the coset which is assigned to a vertex s is exactly the union of the cosets of size two which are assigned to the leaves of the subtree below s . Also, it is straight forward to see that multiplying all labels of the labeled tree $\overline{T}_{3,h}$ with the labeling γ by an arbitrary element $g \in \Gamma$ gives rise to an automorphism of this labeled tree.

For the leaf i , $0 \leq i \leq t - 1$, let $\gamma(i)^*$ be the element of the coset $\gamma(i) = \{\gamma(i)^*, -\gamma(i)^*\}$ which is greater than or equal to 1 and less than or equal to t , and define $k_i \stackrel{\text{def}}{=} \gamma(i)^*$. Then, consider the cyclic t -decomposition of K_n as

$$\mathcal{K}_n \stackrel{\text{def}}{=} (C_n(k_0), C_n(k_1), \dots, C_n(k_{t-1})),$$

for which

$$\{1, 2, \dots, t\} = \{k_0, k_1, \dots, k_{t-1}\}.$$

Then we may construct the graph $\mathcal{K}_n \boxtimes \overline{\mathcal{H}}$ in which

$$\overline{\mathcal{H}} \stackrel{\text{def}}{=} (\overline{T}_{3,h,0}, \overline{T}_{3,h,1}, \dots, \overline{T}_{3,h,t-1})$$

and we have assigned the cylinder $\overline{T}_{3,h,i}$ to the edge set of the subgraph $C_n(k_i)$ of K_n .

Now, by Proposition 2 and the fact that multiplication of the labels of the tree by a fixed element of Γ is an automorphism of the labeled tree itself, we may conclude that all term $\phi(\overline{T}_{h,3} + \overline{\Theta}_j, x)$ are equal for $1 \leq j < n$, and consequently,

$$\phi(\mathcal{K}_n \boxtimes \overline{\mathcal{H}}, x) = \phi(\overline{T}_{h,3} + \overline{\Theta}_1, x)^{2^{h+2}} \phi(\overline{T}_{h,3} + \overline{\Theta}_n, x).$$

Note that $\overline{\Theta}_n$ is a diagonal matrix whose diagonal entries are zero for any vertex which is not a leaf and is equal to 2 for the i th leaf.

As an interesting special case, let $h = 2$ and we have the 3-regular graph $\mathcal{K}_{17} \boxtimes \overline{\mathcal{H}}$ on 238 vertices with the characteristic polynomial

$$(x-3)(x-2)^4(x^2-2x-2)^2(x^2-2)^{17}(x^3-x^2-6x+2) \times \\ (x^{12}+x^{11}-18x^{10}-16x^9+116x^8+88x^7-319x^6-189x^5+345x^4+116x^3-116x^2-12x+7)^{16}$$

which has an automorphism group of order 262. ◆

Example 7. Highly symmetric graphs using $T_{3,h}^\bullet$

Let $t = 3 \times 2^{h-1}$ such that $n = 2t + 1$ is a prime number. Consider the multiplicative group $\Gamma = \mathbb{Z}_n^*$ of the field \mathbb{Z}_n and let a and b be its generators for which $b^3 = 1$ and $a^{2t/3} = 1$.

Label the root of $T_{3,h}^\bullet$ by Γ itself and label each of its siblings as s with $|s| = 1$ by the coset $b^s \langle a \rangle$. Also, let γ be the cyclic group labeling of a complete binary tree of height $h - 1$ under the vertex 0 by the cyclic group $\langle a \rangle$ and for the subtrees below the vertices 1 and 2 apply translation (i.e. multiplying the cosets) by b and b^2 , respectively, of the labeling γ of the subtree under 0.

Again, for the leaf i , let $\gamma(i)^*$ be the element of the coset $\gamma(i) = \{\gamma(i)^*, -\gamma(i)^*\}$ which is greater than or equal to 1 and less than or equal to t , and define $k_i \stackrel{\text{def}}{=} \gamma(i)^*$, and consider the cyclic t -decomposition of K_n as

$$\mathcal{K}_n \stackrel{\text{def}}{=} (C_n(k_0), C_n(k_1), \dots, C_n(k_{t-1}))$$

for which

$$\{1, 2, \dots, t\} = \{k_0, k_1, \dots, k_{t-1}\}.$$

Now, by Proposition 2 we have

$$\phi(\mathcal{K}_n \boxtimes \mathcal{H}^\bullet, x) = \phi(T_{h,3}^\bullet + \Theta_n^\bullet, x) \phi(T_{h,3}^\bullet + \Theta_1^\bullet, x)^{3 \times 2^h}.$$

Note that Θ_n^\bullet is a diagonal matrix whose diagonal entries are zero for any vertex which is not a leaf and is equal to 2 for the i th leaf.

In particular, for $h = 2$ and $n = 13$ we have a 3-regular Ramanujan graph on 130 vertices with the following characteristic polynomial

$$\phi(\mathcal{K}_{13} \boxtimes \mathcal{H}^\bullet, x) = (x-3)(x-1)(x+2)(x-2)^3(x^2-2x-2)^2 \\ \times (x^{10}+x^9-14x^8-12x^7+65x^6+45x^5-115x^4-55x^3+69x^2+12x-10)^{12},$$

with an automorphism group of size 156. ◆

4 Concluding remarks

In this article we considered the spectra of bsymmetric cylindrical constructs when the base-graph has a commutative decomposition. This in our opinion sets another interesting setup where graph decompositions play a crucial role on the one hand, and presents some interesting examples where one may have some observations about the behaviour of the spectrum with a control on the structure of the graph itself. We believe that our results show that the uniform term in Proposition 2 for $j = n$ described in detail in Proposition 3 is a consequence of commutativity of the decomposition since this condition gives rise to the fact that the all-one vector should be the eigenvector of all subgraphs of the corresponding commutative decomposition. This becomes more important when one may verify experimentally that this uniform term is the basic source of eigenvalues outside of the Ramanujan interval, while the number of such eigenvalues for the rest of the terms is relatively very small.

In other words, we believe that our results can be considered as a piece of evidence for the fact that there exists Ramanujan graphs among random sparsifications of the complete graphs by tree-cylinders (e.g. see [12]). This, in our opinion, serves as a strong source of motivation for the study of such construction, where in particular, random π -lifts of complete graphs is the specific case that we believe deserves more careful investigation (see [5]).

From another point of view, our constructions and computations introduce a very specific and important recursive amalgam of polynomials that we believe must be studied in further research for its very interesting properties, since from this more abstract point of view, the recursive procedure presents a way of mixing a couple of polynomials with a control on the spread of the roots of the resultant. It can be verified that this procedure not only works for the diagonal perturbation of trees but also it goes through for the circulant perturbation of trees too, which may also lead to new constructions.

It worths mentioning that spectral properties of the class of highly symmetric graphs introduced in the last section is closely related to number theoretic properties of the corresponding parameters and this class of graphs also deserve more investigations in future research.

References

- [1] Noga Alon. High girth augmented trees are huge. *Journal of Combinatorial Theory, Series A*, 144:7 – 15, 2016. Fifty Years of the Journal of Combinatorial Theory.
- [2] Noga Alon, Alexandr Kostochka, Benjamin Reiniger, Douglas B. West, and Xuding Zhu. Coloring, sparseness and girth. *Isr. J. Math.*, 214(1):315–331, 2016.
- [3] Marko Boben, Tomaž Pisanski, and Arjana Žitnik. I -graphs and the corresponding configurations. *J. Comb. Des.*, 13(6):406–424, 2005.

- [4] Marston D. E. Conder, Tomaž Pisanski, and Arjana Žitnik. Gi-graphs: a new class of graphs with many symmetries. *Journal of Algebraic Combinatorics*, 40(1):209–231, 2014.
- [5] Amir Daneshgar, Mohsen Hejrati, and Meysam Madani. On cylindrical graph construction and its applications. *Electron. J. Comb.*, 23(1):research paper p1.29, 45, 2016.
- [6] Shaun M. Fallat and Charles R. Johnson. *Totally nonnegative matrices*. Princeton, NJ: Princeton University Press, 2011.
- [7] Raluca Gera and Pantelimon Stănică. The spectrum of generalized Petersen graphs. *Australas. J. Comb.*, 49:39–45, 2011.
- [8] Richard Hammack, Wilfried Imrich, and Sand Klavžar. *Handbook of product graphs. 2nd ed.* Boca Raton, FL: CRC Press, 2nd ed. edition, 2011.
- [9] Li He, Xiangwei Liu, and Gilbert Strang. Trees with cantor eigenvalue distribution. *Studies in Applied Mathematics*, 110(2):123–138, 2003.
- [10] Shlomo Hoory, Nathan Linial, and Avi Wigderson. Expander graphs and their applications. *Bull. Am. Math. Soc., New Ser.*, 43(4):439–561, 2006.
- [11] Meysam Madani. Graph amalgams and its applications. *Ph.D. Thesis(In Persian), Sharif University of Technology*, 2016.
- [12] Adam W. Marcus, Daniel A. Spielman, and Nikhil Srivastava. Interlacing families. I: Bipartite Ramanujan graphs of all degrees. *Ann. Math.*, 182(1):307–325, 2015.
- [13] V. B. Mnuhin. Spectra of graphs under certain unary operations (russian). *Nekotorye Topologicheskie i Kombinator. Svoistva Grafov, Akad. Nauk Ukrain. SSR Inst. Mat. Preprint*, 8:38 – 44, 1980.
- [14] Walter Rudin. *Functional analysis*. International Series in Pure and Applied Mathematics. McGraw-Hill Inc., New York, second edition, 1991.
- [15] Gabor Szegő. Orthogonal polynomials. 4th ed. American Mathematical Society Colloquium Publications. Vol. XXIII. Providence, R. I.: American Mathematical Society (AMS). XIII, 432 p., 1975.
- [16] Mark E. Watkins. A theorem on Tait colorings with an application to the generalized petersen graphs. *Journal of Combinatorial Theory*, 6(2):152 – 164, 1969.