

# A Quantum Abacus based encoding system

J. V. Álvarez-Bravo · J. J.  
Álvarez-Sánchez · I. Aparicio-Morgado

Received: date / Accepted: date

**Abstract** A formal description of a quantum abacus based encoding system is presented. This way of representing data for processing purposes is based on a quantum algorithm for counting qubits introduced by Lesovik et al. [1] and Suslov et al. [2], but formally developed in this work. Finally, in order to illustrate the potential of this proposal, the implementation of the basic quantum array operations through this encoding system is presented.

**Keywords** Quantum Fourier Transform · Phase Estimation Algorithm · Quantum encoding circuit · Elementary Quantum gates · Qubits

## 1 Introduction

Quantum computing paradigm is currently one of the most active and promising research area. From the first contributions, in areas such as cryptography [3] or speeding-up some classical algorithms [4,5,6,7,8], up to present, many works have laid the foundations about how to represent and process data under

---

J. V. Álvarez-Bravo  
Escuela de Ingeniería Informática de Segovia  
Tel.: +34-921-112454  
Fax: +34-921-112400  
E-mail: jvalvarez@infor.uva.es

J. J. Álvarez-Sánchez  
Escuela de Ingeniería Informática de Segovia  
Tel.: +34-921-112430  
Fax: +34-921-112400  
E-mail: jjalvarez@infor.uva.es

Jl. Aparicio-Morgado  
Escuela de Ingeniería Informática de Segovia  
Tel.: +34-921-112419  
Fax: +34-921-112400  
E-mail: ignacio@infor.uva.es

the rules of quantum mechanics. There are many reasons for this increasing interest, some of them were pointed out by Feynmann in his well-known dissertation [9], but all of them can be summarized just in one: the Quantum computer is the only way of overcoming the limitations imposed to the Classical one by Moore's Law. Different approaches have been proposed for carrying out this great challenge [10]. The most accepted, the standard model, defines the quantum computer as a circuit-based computing system where a sequence of unitary gates act coherently on an input register of qubits [11]. The aim of this work is to contribute from this last perspective providing an efficient quantum circuit for encoding and processing quantum data. The quantum encoding system presented in this work is based on the Quantum Abacus (QA), a quantum algorithm for counting qubits introduced by Lesovik et al. [1] and Suslov et al. [2] but formally described in our work in terms of a deterministic QFT based Phase Estimation Algorithm. The main idea can be merely described as follows: since the output of the QA circuit is the number of qubits in a sequence, then the underlying representation can be used for encoding any integer number. In this case, the underlying representation is a set of phase shifts standing for the QFT of the output. The key point is how the QA circuit allows to infer easily a compact expression for these phase shifts in terms of elementary quantum gates, the encoding circuit, and how this one can be used, for instance, to implement the basic operations of a simple quantum data structure.

The paper has been organized as follows: In section 2 a deterministic Phase Estimation Algorithm schema (PEA) based on QFT is described. In this regard, the zero failure rate condition is achieved and used for implementing the case when the number of input qubits is equal to the number of ancillary qubits. In section 3, the Quantum Abacus circuit is formally described in terms of a PEA schema. In section 4, the framework for quantum encoding, by means of a QA, is presented. In section 5, in order to shed light on how to use this proposal, the implementation of creating and updating Quantum array operation are presented. Finally, in section 6, a brief set of conclusions summarize the contributions of this paper.

## 2 The QFT based Phase Estimation Algorithm: the zero failure rate condition

Let us suppose a  $2^n \times 2^n$  unitary operator  $U$  defined in terms of the problem to be solved. If  $|\psi_j\rangle$  and  $\lambda_j$  are eigenvectors and eigenvalues of  $U$  respectively in such a way that:

$$U = \sum_{j=0}^{2^n-1} \lambda_j |\psi_j\rangle \langle \psi_j| \quad \text{where} \quad \lambda_j = e^{i2\pi\phi_j} \quad \text{and} \quad \phi_j \in [0, 1) \quad (1)$$

The Phase Estimation Algorithm (PEA) is defined as the process of estimating  $\phi_j$  with a specific precision when the input is a register containing the

corresponding eigenvector  $|\psi_j\rangle$  of  $U$ . In this work, a formulation of the PEA based on QFT will be considered [12] and is shown in Figure 1.

Under this schema, the estimation process is efficiently carried out according to the following steps:

1. The ancillary register is prepared containing an evenly distributed superposition. The number of qubits of the ancillary register determines the estimation accuracy.
2. Given a particular eigenvector  $|\psi_j\rangle$  of  $U$  as an input, the next step consists on kicking the corresponding phases in front of the ancillary register through the action of the controlled powers of  $U$  denoted as  $c_U^{2^l}$  for  $l = m - 1, \dots, 0$ , being  $m$  the number of qubits of the ancillary register.
3. In order to make  $\phi_j$  an observable quantity in the computational basis, the inverse of QFT is applied on the ancillary register.
4. Then, a measurement process determines  $\phi_j$  with a high probability and a precision lower than  $1/2^m$ .

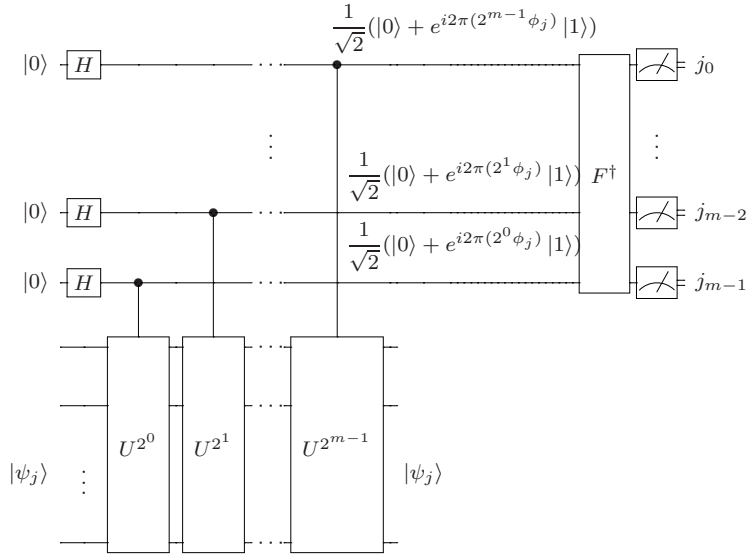

**Fig. 1** Detailed schema of QFT based PEA

Adding up steps 1 to 4, a summarized formal description is presented:

$$\begin{aligned}
 & |0^{\otimes(m)}, \psi_j\rangle \xrightarrow{H^{\otimes m} \otimes \hat{I}^{\otimes(n)}} \frac{1}{\sqrt{2^m}} \bigotimes_{l=m-1}^0 (|0\rangle |\psi_j\rangle + |1\rangle |\psi_j\rangle) \xrightarrow{\otimes \hat{I}^{\otimes(m)} \otimes c_U^{2^l}} \quad (2) \\
 & = \frac{1}{\sqrt{2^m}} \bigotimes_{l=m-1}^0 (|0\rangle |\psi_j\rangle + |1\rangle e^{i2\pi(2^l \phi_j)} |\psi_j\rangle) = \frac{1}{\sqrt{2^m}} \bigotimes_{l=m-1}^0 (|0\rangle + e^{i2\pi(2^l \phi_j)} |1\rangle) |\psi_j\rangle \quad (3)
 \end{aligned}$$

As can be observed in equation (3), the phase shift is kicked in front of the ancillary register and the eigenvector  $|\psi_j\rangle$  remains unchanged. Equation (3) can be rewritten as:

$$\frac{1}{\sqrt{2^m}} \sum_{k=0}^{2^m-1} e^{i2\pi k\phi_j} |k\rangle \quad (4)$$

then applying the inverse of the QFT to the state described in equation (4) we figure out the probability to measure an individual output  $j$  over the ancillary register given by:

$$P_j = \left| \frac{1}{2^m} \sum_{k=0}^{2^m} e^{i2\pi k(\phi_j - \frac{j}{2^m})} \right|^2 \quad (5)$$

In equation (5),  $j/2^m$  may be considered as a good estimator of  $\phi_j$ . Since certainty occurs when  $P_j = 1$  then, from equation (5), the algorithm becomes deterministic when

$$\phi_j - j/2^m = 0$$

is fulfilled; the so called *zero theoretical failure rate condition*. That situation takes place when  $\phi_j$  is expressed as a finite binary expansion by means of  $m$  bits.

## 2.1 The case of $m = n$ : a simple example

As a first approach for working out the set of unitary operators satisfying the *zero theoretical failure rate condition* we face up the case where the number of ancillary states  $m$ , and the number of input quantum states  $n$ , are equal,  $m = n$ . Under this condition  $\phi_j$  is written as follows:

$$2^l \phi_j = 2^l \frac{j}{2^n} = \sum_{k=0}^{n-1} j_k 2^{k-n+l} \quad \text{with } j_k \in \{0, 1\} \quad \text{and } l = n-1 \dots 0 \quad (6)$$

It is worth it noticing that for any  $j_k$  fulfilling  $k - n + l \geq 0$  there will be no contribution to the kicked phase shift. Therefore, equation (6), can be rewritten as its *principal value* which is given by:

$$2^l \phi_j = \sum_{k=0}^{n-1-l} j_k 2^{k-n+l} \quad (7)$$

Now, imposing equation (7) to equation (3), the ancillary register becomes the QFT of the eigenvector  $|\psi_j\rangle = |j_{n-1}j_{n-2}\cdots j_1j_0\rangle$ :

$$\begin{aligned} & \frac{1}{\sqrt{2^n}} \bigotimes_{l=n-1}^0 \left( |0\rangle + e^{i2\pi(2^l \phi_j)} |1\rangle \right) \\ &= \frac{1}{\sqrt{2^n}} \bigotimes_{l=n-1}^0 \left( |0\rangle + e^{i2\pi(\sum_{k=0}^{n-1-l} j_k 2^{k-n+l})} |1\rangle \right) \end{aligned} \quad (8)$$

$$= \frac{1}{\sqrt{2^n}} \left( |0\rangle + e^{i2\pi(0.j_0)} |1\rangle \right) \cdots \left( |0\rangle + e^{i2\pi(0.j_{n-1}\cdots j_0)} |1\rangle \right) \quad (9)$$

In Figure 2, a PEA schema with a set  $c_U^{2^l}$  of operators fulfilling equation (7) is implemented in terms of a tensor composition of controlled  $z$ -rotation gates  $R_k$  that act in the following way:

$$R_k |jm\rangle = e^{i\frac{2\pi(j\cdot m)}{2^k}} |jm\rangle$$

So,  $R_k$  performs a clockwise  $\frac{(j\cdot m)}{2^{k-1}}\pi$  rotation only when the condition  $j = m = 1$  is fulfilled.

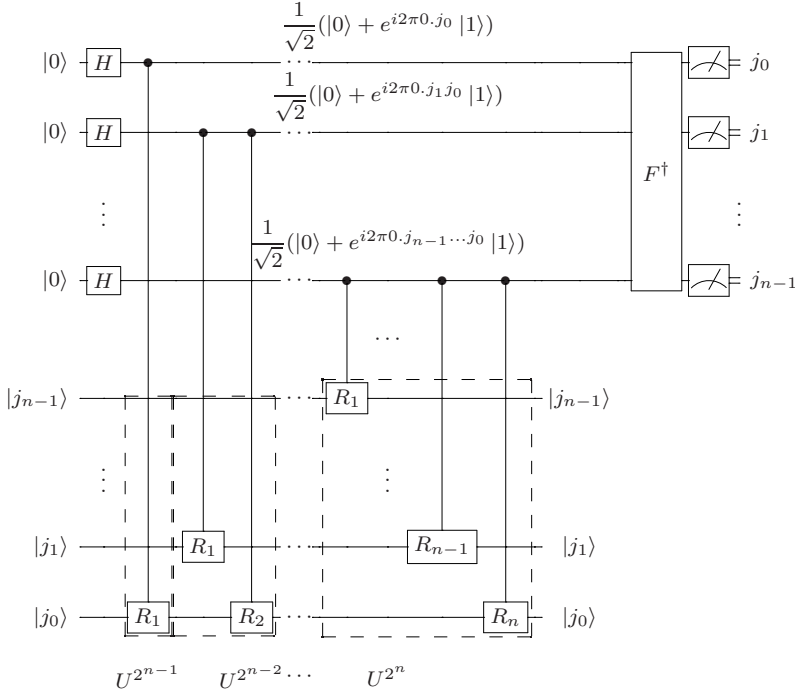

**Fig. 2** Detailed schema of a zero failure rate PEA using controlled  $z$ -rotation gates

According to that,  $U^{2^0}$  can be represented as a diagonal matrix whose eigenvectors are the elements of the standard basis and its corresponding eigen-

values (diagonal elements) are phase shifts. The particular case of  $U^{2^0}$  for  $n = 2$  is presented in Table 1.

$U^{2^0}$	$ \psi\rangle =  j_1 j_0\rangle$	$\lambda$	$\phi = j/2^n$	$j$
$\mathbb{1}_{4 \times 4} \begin{bmatrix} e^{i2\pi(0)} \\ e^{i2\pi(\frac{1}{4})} \\ e^{i2\pi(\frac{1}{2})} \\ e^{i2\pi(\frac{3}{4})} \end{bmatrix}$	$ 00\rangle$	1	0	0
	$ 01\rangle$	$i$	1/4	1
	$ 10\rangle$	-1	1/2	2
	$ 11\rangle$	$-i$	3/4	3

**Table 1** Detailed description of  $U^{2^0}$  for  $n = 2$  and  $f_k \in \{0, 1\}$

### 3 A deterministic dircuit for counting qubits: the Quantum Abacus

The key point now is to implement a deterministic PEA based quantum circuit for counting how many qubits there are in a sequence. From a computational point of view this problem can be reduced to describe the circuit for counting how many 1's and 0's there are in the mentioned sequence given the current computational state of the qubit. In fact, this circuit can be considered as the composition of two independent circuits, once for counting 1's and another one for counting 0's. Since both circuits are formally equivalents, just one will be considered for our research purposes. As it was seen in the previous section, the way to tackle this problem involves a specific definition of parameter  $\phi_j$  in terms of the problem to be solved. If  $|q_{n-1}q_{n-2} \cdots q_1q_0\rangle$  is the input register containing a sequence of  $n$  qubits, then the number of qubits with 1's,  $N_{|1\rangle}$ , or the number of qubits with 0's,  $N_{|0\rangle}$ , in this sequence is described in decimal form as:

$$N_{|1\rangle} = \sum_{k=0}^{n-1} q_k \quad \text{or} \quad N_{|0\rangle} = \sum_{k=0}^{n-1} \bar{q}_k \quad \text{for} \quad q_k \in \{0, 1\} \quad (10)$$

For the sake of simplicity and since both are formally identical, just one, the case when the qubit is  $|1\rangle$ , will be explicitly worked out. Then  $\phi_{|1\rangle}$  is defined as:

$$\phi_{|1\rangle} = \frac{1}{2^m} N_{|1\rangle} = \frac{1}{2^m} \sum_{k=0}^{n-1} q_k = \sum_{k=0}^{n-1} q_k 2^{-m} \quad \text{where} \quad q_k \in \{0, 1\} \quad (11)$$

where  $m$  is the number of qubits of the ancillary register such that  $m = \lceil (\log_2 n) \rceil$ . This condition is introduced in order to guarantee an optimal binary representation of the number of 1's after the measuring process. From the zero

theoretical failure rate condition  $\phi_{|1\rangle} - j/2^m = 0$ , so, the next identity is yielded:

$$\frac{1}{2^m} \sum_{k=0}^{n-1} q_k - \frac{1}{2^m} \sum_{l=0}^{m-1} j_l 2^l = 0 \quad \longrightarrow \quad \sum_{k=0}^{n-1} q_k = \sum_{l=0}^{m-1} j_l 2^l \quad (12)$$

Equation (12) expresses how a PEA based circuit defined with a phase according to equation (11) will return, after applying the inverse of QFT, the binary representation of the number of 1's in the input sequence of qubits. Following the previous ideas it is not difficult to build the corresponding chain of transformations for a  $U^{2^l}$  satisfying (11):

$$|0^{\otimes(m)}, q^{\otimes(n)}\rangle \xrightarrow{H^{\otimes(m)} \otimes I^{\otimes(n)}} \frac{1}{\sqrt{2^m}} \bigotimes_{l=m-1}^0 (|0\rangle + |1\rangle) |q^{\otimes(n)}\rangle \quad (13)$$

$$\xrightarrow{c-U^{2^l}} = \frac{1}{\sqrt{2^m}} \bigotimes_{l=m-1}^0 \left( |0\rangle + |1\rangle e^{i2\pi(2^l \sum_{k=0}^{n-1} q_k 2^{-m})} \right) |q^{\otimes(n)}\rangle \quad (14)$$

where the ancillary register takes the form:

$$\begin{aligned} \bigotimes_{l=m-1}^0 |\varphi_l\rangle &\equiv \bigotimes_{l=m-1}^0 \frac{1}{\sqrt{2}} \left( |0\rangle + e^{i2\pi 2^{l-m} (\sum_{k=0}^{n-1} q_k)} |1\rangle \right) \\ &= \frac{1}{\sqrt{2^m}} \bigotimes_{l=m-1}^0 \left( |0\rangle + e^{i\pi (\sum_{k=0}^{n-1} q_k)} |1\rangle \right) \dots \left( |0\rangle + e^{i\pi \frac{1}{2^{m-1}} (\sum_{k=0}^{n-1} q_k)} |1\rangle \right) \end{aligned} \quad (15)$$

Again, a tensor composition of controlled  $z$ -rotation gates is involved to reproduce the corresponding phase shift addition. In order to yield a correct representation of counting register a set of Swap gates are placed after the inverse QFT. The circuit corresponding to equation (15) is scalable and its algorithmic complexity is easily worked out just taking into account the following issues:

- there is an arrangement of  $\mathcal{O}(\log n)$  dashed boxes
- each dashed box contains exactly  $n$  quantum rotational gates

This gives an amount of  $\mathcal{O}(n \log n)$  quantum gates as it is shown in Figure 3 where, a deterministic quantum circuit for counting 1's from a register containing a sequence of  $n$  qubits, is drawn.

In Table 2, the particular case of  $U^{2^0}$  when  $n = 3$  for the previous circuit, is presented.

Given the ambiguity of who controls whom that occurs in those quantum circuits where controlled- $U$  gates are involved (Figure 5), an equivalent circuit for counting 1's may be proposed (Figure 4) reorganizing the circuit in Figure 3. In this case the controlled  $z$ -Rotation gates are applied directly on the ancillary qubits.

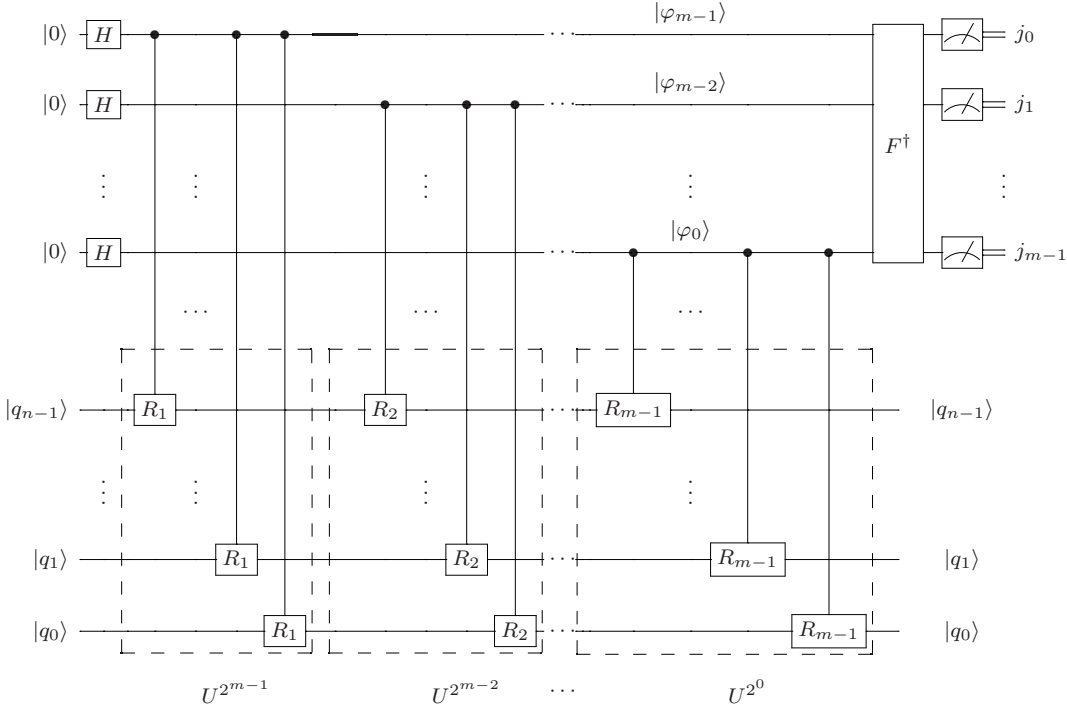

**Fig. 3** The deterministic circuit for counting how many 1's there are in a particular sequence of qubits

	$U^{2^0}$	$ q_2 q_1 q_0\rangle$	$\lambda$	$\phi$	$q_{ 1\rangle} = \sum_{k=0}^2 q_k = j$
$\mathbb{1}_{8 \times 8}$	$e^{i2\pi(0)}$	000>	1	0	0
	$e^{i2\pi(\frac{1}{4})}$	001>	$i$	1/4	1
	$e^{i2\pi(\frac{1}{4})}$	010>	$i$	1/4	1
	$e^{i2\pi(\frac{1}{2})}$	011>	-1	1/2	2
	$e^{i2\pi(\frac{1}{4})}$	100>	$i$	1/4	1
	$e^{i2\pi(\frac{1}{2})}$	101>	-1	1/2	2
	$e^{i2\pi(\frac{1}{2})}$	110>	-1	1/2	2
	$e^{i2\pi(\frac{3}{2})}$	111>	$-i$	3/2	3

**Table 2** Detailed description of  $U^{2^0}$  for  $n = 3$  and  $q_k \in \{0, 1\}$

This arrangement presents interesting similitudes with a classical abacus device where controlled shifts, applied on the ancillary qubits, play the role of tokens for counting. As it will be seen in the next section, this special feature becomes the base of an encoding system for integer numbers.



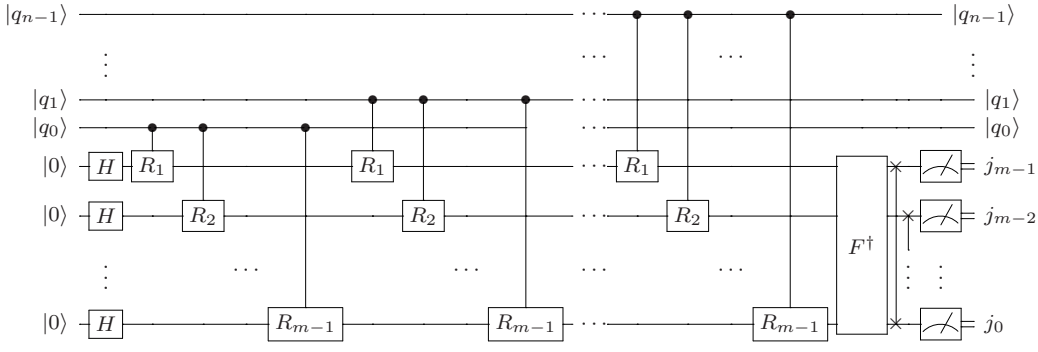

**Fig. 4** An equivalent circuit for counting 1's

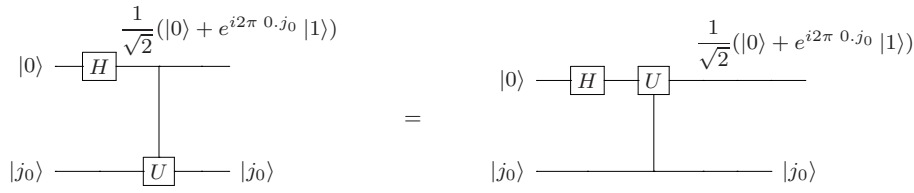

**Fig. 5** Ambiguity of who controls whom

#### 4 Building the framework for quantum encoding

The previous schema, without the control qubits, may be used for building the framework for quantum encoding since, any binary number, may be encoded in terms of shifts. The unitary operator associated to this circuit will be denoted, from now on, as  $U^c$ . The set of transformations for this encoding process over a  $n$  qubits quantum register is written as follows:

$$|0^{\otimes(n)}\rangle \xrightarrow{H^{\otimes(n)}} \frac{1}{\sqrt{2^n}} \bigotimes_{l=n-1}^0 (|0\rangle + |1\rangle) \xrightarrow{U^{c \otimes(n)}} \quad (16)$$

$$= \frac{1}{\sqrt{2^n}} \bigotimes_{l=n-1}^0 (|0\rangle + e^{i2\pi \phi_d(l)} |1\rangle) \quad (17)$$

From equation (16), the encoding process is carried out through the phase  $2\pi\phi_d(l)$  where the factor  $\phi_d(l)$ <sup>1</sup> is given by:

$$\phi_d(l) = (d \bmod 2^{n-l}) \frac{1}{2^{n-l}} \quad (18)$$

<sup>1</sup> From now on, and for sake of simplicity, we will refer to the factor  $\phi_d(l)$  as the *phase*  $\phi_d(l)$ .

In equation (18),  $d$  is the decimal representation of the encoded data. Obviously,  $\phi_l$  can be rewritten as:

$$\phi_d(l) = (d \bmod 2^{n-l}) \frac{1}{2^{n-l}} = \sum_{k=0}^{n-l-1} d_k 2^{k-n+l} = \left( \frac{d_{n-l-1}}{2} + \frac{d_{n-l-2}}{4} + \dots + \frac{d_0}{2^l} \right) \quad (19)$$

In equation (19),  $\phi_d(l)$  is the phase yielded as a result of applying the QFT to a register containing the binary representation of  $d$ . Then, if the inverse of QFT, followed by a set of Swap gates, are applied over the register the binary representation of the encoded data is retrieval.

$$Sw^{\otimes(n)} \cdot F^{\dagger \otimes(n)} \left( \frac{1}{\sqrt{2^n}} \bigotimes_{l=n-1}^0 \left( |0\rangle + e^{i2\pi\phi_d(l)} |1\rangle \right) \right) = |d_{n-1} \dots d_0\rangle \quad (20)$$

The general quantum encoding circuit (QC) and an instance representing number 5 are shown in Figures 6 and 7.

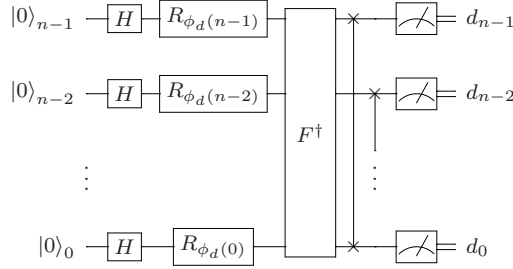

**Fig. 6** a) General quantum encoding circuit where  $R_{\phi_d(l)}$  is the quantum gate that performs the phase rotation of the angle  $2\pi\phi_d(l)$ .

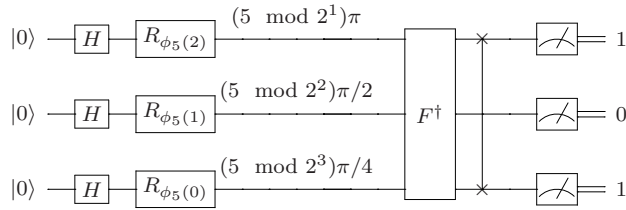

**Fig. 7** b) Codification of number 5 and the retrieval process to achieve its binary representation.

## 5 Implementation of a Quantum Array using the quantum encoding Circuit

An application of this encoding system is related to the implementation of a quantum data structure that we called as a *quantum array*. From a classical point of view an array, also known as vector, is a data structure where stored data of a specific type is accessible through an index. This description can be used in the quantum context defining the corresponding storage structure and its fundamental operations. In the quantum world, a collection of data may be stored in a single register through an evenly distributed superposition of states. This way of storage comprises  $2^m$  classical states on just one  $m$  qubit register. The quantum array can be implemented from a superposition of states dividing the register in two different logical parts. The first one stores the most significant qubits and denotes the index that will be used for accessing to the data while, the second one, the logical part with the less significant ones, makes reference to the data itself. The number of qubits of each part will depend on the number of elements of the database and the size of the data respectively. For the sake of simplicity, the number of elements of the array will be always a power of two. In practice, this is not a problem since the array can be padded with zeros. So, if the quantum array size is  $M = 2^m$  then the index will be stored through  $m$  qubits in such a way that, if  $p$  is the necessary number of qubits for a suitable representation of data, then the quantum register structure takes this form:

$$|j_{m-1} \cdots j_0, d_{p-1} \cdots d_0\rangle \quad (21)$$

Given this basic structure, the creating and updating operations are defined as follows<sup>2</sup>:

*Creating a Quantum Array* The following steps are involved for creating a specific quantum array:

1. An initial ancillary register of  $m + p$  qubits is set to 0 and a set of  $m + p$  Hadamard gates are applied on each ancillary qubit in order to generate the initial superposition.
2. Next, the corresponding  $U^c$  operator is applied to encode the data.
3. Finally, the application of the inverse of QFT on this latter qubits to retrieve the binary representation of data.

It is important to remark that  $U^c$  operator can be implemented combining both, multiple controlled shift gates and just unary shift gates. In the former case, the control action is achieved through the index qubits in such a way that each superposition state generated on the former  $m$  qubits is linked to a specific phase shift encoding, in this manner:

---

<sup>2</sup> The operation for data retrieving will be carried out by means of the generalization of Grover's algorithm [13].

$$|0^{\otimes(m)}, 0^{\otimes(p)}\rangle \xrightarrow{H^{\otimes(m+p)}} \frac{1}{\sqrt{2^m}} \sum_{j=0}^{2^m-1} |j\rangle \frac{1}{\sqrt{2^p}} \bigotimes_{l=1}^p (|0\rangle + |1\rangle) \xrightarrow{U^c} \quad (22)$$

$$= \frac{1}{\sqrt{2^m}} \sum_{j=0}^{2^m-1} |j\rangle U^c \left( \frac{1}{\sqrt{2^p}} \bigotimes_{l=1}^p (|0\rangle + |1\rangle) \right) \quad (23)$$

$$= \frac{1}{\sqrt{2^m}} \sum_{j=0}^{2^m-1} |j\rangle \left( \frac{1}{\sqrt{2^p}} \bigotimes_{l=1}^p (|0\rangle + e^{i2\pi(\phi^j + \phi)_l} |1\rangle) \right) \xrightarrow{F_p^\dagger} \quad (24)$$

$$= \frac{1}{\sqrt{2^m}} \sum_{j=0}^{2^m-1} |j\rangle \hat{F}_p^\dagger \left( \frac{1}{\sqrt{2^p}} \bigotimes_{l=1}^p (|0\rangle + e^{i2\pi(\phi^j + \phi)_l} |1\rangle) \right) \quad (25)$$

$$= \frac{1}{\sqrt{2^m}} \sum_{j=0}^{2^m-1} |j, d^j\rangle \quad (26)$$

where  $d^j$  is the decimal representation of data stored in the  $j$  position of the quantum array. The encoding process is carried out through the corresponding phase shift  $(\phi^j + \phi)_l$  such that  $\phi^j$ , dependent shift phase of  $j$ , is achieved through the multiple controlled phase shift gates and the parameter  $\phi^3$ , whether elementary phase shift gates are involved. Both phases are expressed through equation (18). In Figures 8 and 9, two schematic circuits summarizing the previous description for storing numbers are presented:

- The first one stores any four numbers that may represent, for instance, a contact list.
- The second one stores the first four odd numbers.

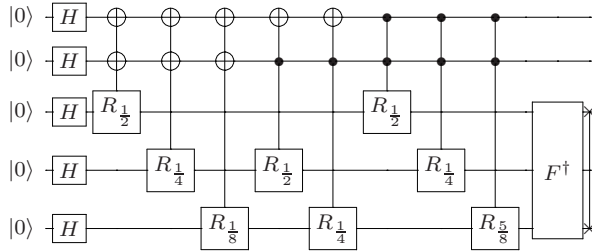

**Fig. 8** a) the corresponding one storing the numbers 1,2,0,5 according to this order  $(|0, 1\rangle + |1, 2\rangle + |2, 0\rangle + |3, 5\rangle)$ .

It is important to realize that, when the information to be stored is described by an arithmetic series (latter example), the quantum array can be implemented taking advantage of quantum parallelism.

<sup>3</sup> A parameter representing a shift phase independent of  $j$ .

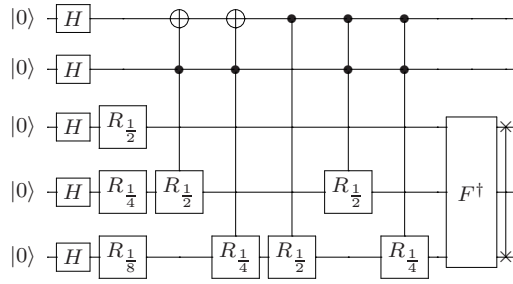

**Fig. 9** b) the corresponding one storing the first four odd numbers ( $|0, 1\rangle + |1, 3\rangle + |2, 5\rangle + |3, 7\rangle$ ).

*Updating a Quantum Array.* Once the quantum array is created any element within it may be modified. In fact, through the encoding system, a subset of the quantum array states or all of them may be modified simultaneously. In Figure 10<sup>4</sup>, a quantum circuit for adding a number, for instance 1, just over the even positions of a predefined quantum array, is described. This operation is performed simultaneously over all the involved states. In order to clarify

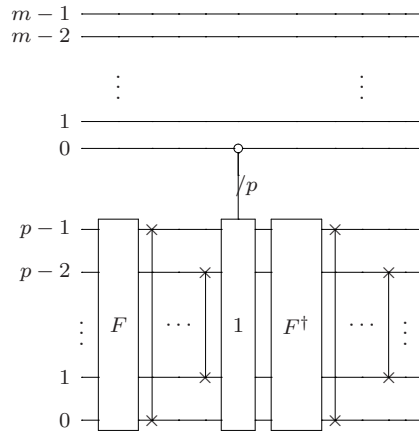

**Fig. 10** Adding 1 just over the even positions of a predefined quantum array.

<sup>4</sup> In Figure 10 the following equivalences have been applied:

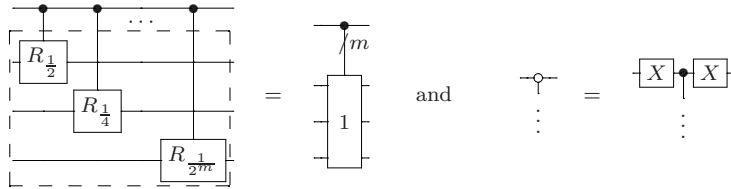

this process a detailed mathematical description step by step is shown:

1. First a quantum register is prepared in a quantum superposition state  $|\psi\rangle$

$$|\psi\rangle = \frac{1}{\sqrt{2^m}} \sum_{j=0}^{2^m-1} |j, d^j\rangle$$

2. The following quantum operators are applied

$$\left( I^{\otimes m} \otimes (Sw^{\otimes(p)} \cdot F^{\otimes(p)}) \right) |\psi\rangle$$

3. Letting the quantum register in the quantum state written below  $|\psi\rangle$

$$\frac{1}{\sqrt{2^m}} \sum_{j=0}^{2^m-1} |j\rangle \otimes \left( \frac{1}{\sqrt{2^p}} \bigotimes_{l=p-1}^0 \left( |0\rangle + e^{i2\pi d^j 2^{-p+l}} |1\rangle \right) \right)$$

4. Then the quantum operator  $C_{-1j_{\text{even}}}$  is applied and an *even* and *odd* decomposition is achieved

$$\begin{aligned} & \frac{1}{\sqrt{2^m}} \sum_{j_{\text{even}}=0}^{2^m-1} |j\rangle \otimes \left( \frac{1}{\sqrt{2^p}} \bigotimes_{l=p-1}^0 \left( |0\rangle + e^{i2\pi(d^j+1)2^{-p+l}} |1\rangle \right) \right) \\ & + \frac{1}{\sqrt{2^m}} \sum_{j_{\text{odd}}=0}^{2^m-1} |j\rangle \otimes \left( \frac{1}{\sqrt{2^p}} \bigotimes_{l=p-1}^0 \left( |0\rangle + e^{i2\pi d^j 2^{-p+l}} |1\rangle \right) \right) \end{aligned} \quad (27)$$

5. Finally the QFT inverse acts

$$I^{\otimes m} \otimes (Sw^{\otimes(p)} \cdot F^{\otimes(p)})$$

and the quantum register takes the following form

$$|\psi'\rangle = \frac{1}{\sqrt{2^m}} \sum_{j=0}^{2^m-1} |j, d'^j\rangle$$

where  $d'^j = d^j + 1$ , if  $j$  is an *even* number and  $d'^j = d^j$  if  $j$  is an *odd* number.

## 6 Conclusions

Our contribution on this paper has been to provide a quantum framework for manipulating data on a quantum data structure. This framework, the Quantum Abacus based encoding system, allows to work with any integer numbers in terms of phase shifts instead of its corresponding binary representation. In this context, a Quantum Abacus is a circuit for counting qubits depending on its current computational state. A formal description of this latter circuit, in terms of a QFT based PEA schema, is also presented. In order to show the

possibilities of this framework, the implementation of creating and updating operations of a quantum data structure (Quantum Array) has been achieved, taking advantage, when it has been possible, of quantum parallelism.

**Acknowledgements** This work was partially supported by the Spanish Ministerio de Economía y Competitividad (MINECO) under project MTM2014-57129-C2-1-P.

## References

1. Lesovik, G. B., Suslov, M.V. Blatter, G. Quantum Counting Algorithm and its Applications in Mesoscopic Physics-. *Physical Review A.*, 82:012316, Jul 2010.
2. M. V. Suslov, G. B. Lesovik, and G. Blatter. Quantum abacus for counting and factorizing numbers. *Phys. Rev. A*, 83:052317, May 2011.
3. Charles H. Bennett and Gilles Brassard. Quantum cryptography: Public key distribution and coin tossing. In *Theoretical Aspects of Quantum Cryptography celebrating 30 years of BB84*, volume 560, Part 1, pages 7–11, 2014.
4. Deutsch, D. Jozsa, R. Rapid Solutions of Problems by Quantum Computation. In *Proceedings of the Royal Society of London*, number 439 in Series A, pages 535558, 1992.
5. Bernstein, E. Vazirani, U. Quantum Complexity Theory. *SIAM J. Comput.*, 26(5), 14111473, 1997.
6. Simon, D. On the Power of Quantum Computation. In *Proceedings IEEE FOCS*, pages 116123, 1994.
7. Shor, P.W. Algorithms for quantum computation: discrete logarithms and factoring. In *Foundations of Computer Science, 1994 Proceedings., 35th Annual Symposium on*, pages 124134, November 1994.
8. Grover, Lov K. A fast quantum mechanical algorithm for database search. In *Proceedings STOC 96*, pages 212219, 1994.
9. Feynman, R. Simulating Physics with Computers. *International Journal of Theoretical Physics*, 21(6/7):467488, 1982.
10. Van Meyer, R., Horsman, C. A blueprint for building a quantum computer. *Communications of ACM*, 56(10), 84-93, 2013.
11. Nielsen, M. A. Chuang, I. L. *Quantum computation and quantum information*. 2000.
12. Cleve, R., Ekert, A., Machiavello, C. Mosca, M. Quantum Algorithms Revisited. In *Proceedings of the Royal Society of London*, number 454 in Series A, pages 339354, 1998.
13. Brassard, G., Hyer P., Mosca M., Tapp A. Quantum Amplitude Amplification and Estimation. *Contemporary Mathematics Series Millennium Volume*, 305, 2002.