

# An Importance Sampling Scheme for Models in a Strong External Field

Mehdi Molkaiaie  
 Universitat Pompeu Fabra  
 08018 Barcelona, Spain  
 mehdi.molkaiaie@alumni.ethz.ch

**Abstract**—We propose Monte Carlo methods to estimate the partition function of the two-dimensional Ising model in the presence of an external magnetic field. The estimation is done in the dual of the Forney factor graph representing the model. The proposed methods can efficiently compute an estimate of the partition function in a wide range of model parameters. As an example, we consider models that are in a strong external field.

## I. INTRODUCTION

In [1], the authors showed that for the two-dimensional (2D) Ising model, at low temperature, Monte Carlo methods converge faster in the dual Forney factor graph than in the original (primal) factor graph. Monte Carlo methods based on the dual factor graph were also proposed in [1] to estimate of the partition function of the 2D Ising model in the absence of an external magnetic field (see also [2]).

In thermodynamic limits, the exact value of the partition function of the 2D Ising model, with constant couplings and in the absence of an external field, was first calculated by Onsager [3], [4, Chapter 7]. However, the 2D Ising model in an arbitrary non-zero external field and the three-dimensional (3D) Ising model have remained unsolved [5].

In general, the partition function of 2D models with arbitrary couplings can be estimated using Markov chain Monte Carlo methods [6]–[8]. In this paper, we consider the problem of estimating the partition function of the “finite-size” 2D ferromagnetic Ising model in a consistent external field. We propose Monte Carlo methods in the dual of the Forney factor graph representing the model that can efficiently estimate the partition function. As a special case, we consider models that are in a strong external magnetic field.

The paper is organized as follows. In Section II, we review the Ising model and graphical model representations in terms of Forney factor graphs. Dual Forney factor graphs and the factor graph duality theorem are discussed in Section III. The proposed Monte Carlo methods are described in Section IV. Numerical experiments are reported in Section V.

## II. THE ISING MODEL IN AN EXTERNAL MAGNETIC FIELD

Let  $X_1, X_2, \dots, X_N$  be a collection of discrete random variables arranged on the sites of a 2D lattice, as illustrated in Fig. 1, where interactions are restricted to adjacent (nearest-neighbor) variables. Suppose each random variable takes on values in a finite alphabet  $\mathcal{X}$ . Let  $x_i$  represent a possible

realization of  $X_i$ ,  $\mathbf{x}$  stand for a configuration  $(x_1, x_2, \dots, x_N)$ , and  $\mathbf{X}$  stand for  $(X_1, X_2, \dots, X_N)$ .

In a 2D Ising model,  $\mathcal{X} = \{0, 1\}$  and the Hamiltonian (the energy function) of a configuration  $\mathbf{x}$  is defined as [4]

$$\mathcal{H}(\mathbf{x}) \triangleq - \sum_{(k, \ell) \in \mathcal{B}} J_{k, \ell} \cdot ([x_k = x_\ell] - [x_k \neq x_\ell]) - \sum_{m=1}^N H_m \cdot ([x_m = 1] - [x_m = 0]) \quad (1)$$

where  $\mathcal{B}$  contains all the unordered pairs (bonds)  $(k, \ell)$  with non-zero interactions and  $[ \cdot ]$  denotes the Iverson bracket [9, Chapter 2], which evaluates to 1 if the condition in the bracket is satisfied and to 0 otherwise.

The real coupling parameter  $J_{k, \ell}$  controls the strength of the interaction between adjacent variables  $(x_k, x_\ell)$ . The real parameter  $H_m$  corresponds to the presence of an external magnetic field. In this paper, we concentrate on ferromagnetic models, characterized by  $J_{k, \ell} > 0$  for each  $(k, \ell) \in \mathcal{B}$ . The external field is assumed to be consistent, i.e., for  $1 \leq m \leq N$ ,  $H_m$  is either assigned to all positive or to all negative values.

The probability that the model is in configuration  $\mathbf{x}$  is given by the Boltzmann distribution [4]

$$p_{\mathcal{B}}(\mathbf{x}) = \frac{e^{-\beta \mathcal{H}(\mathbf{x})}}{Z} \quad (2)$$

Here, the normalization constant  $Z$  is the *partition function*  $Z = \sum_{\mathbf{x} \in \mathcal{X}^N} e^{-\beta \mathcal{H}(\mathbf{x})}$  and  $\beta = 1/k_{\text{B}}T$ , where  $T$  denotes the temperature and  $k_{\text{B}}$  is Boltzmann’s constant.

In the rest of this paper, we will assume  $\beta = 1$ . Hence, large values of  $J$  and  $|H|$  correspond to models at low temperature and in a strong external field. Boundary conditions are assumed to be periodic throughout this paper. Thus  $|\mathcal{B}| = 2N$ .

For each adjacent pair  $(x_k, x_\ell)$ , let

$$\kappa_{k, \ell}(x_k, x_\ell) = e^{J_{k, \ell} \cdot ([x_k = x_\ell] - [x_k \neq x_\ell])} \quad (3)$$

and for each  $x_m$

$$\tau_m(x_m) = e^{H_m \cdot ([x_m = 1] - [x_m = 0])} \quad (4)$$

We then define  $f : \mathcal{X}^N \rightarrow \mathbb{R}_{>0}$  as

$$f(\mathbf{x}) \triangleq \prod_{(k, \ell) \in \mathcal{B}} \kappa_{k, \ell}(x_k, x_\ell) \prod_{m=1}^N \tau_m(x_m) \quad (5)$$

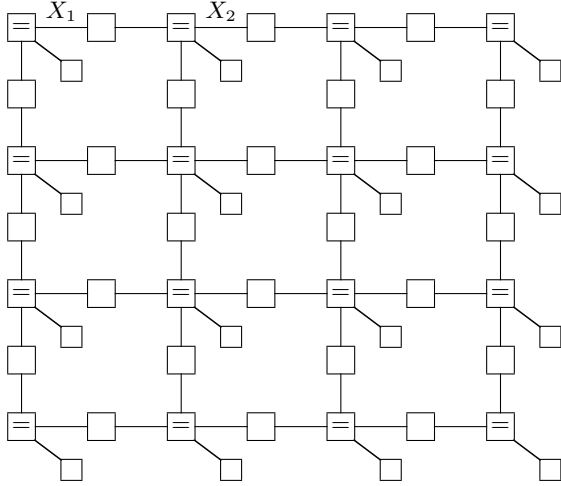

Fig. 1. Forney factor graph of the 2D Ising model in an external field, where unlabeled normal-size boxes represent (3), small boxes represent (4), and boxes containing “=” symbols are equality constraints.

The corresponding Forney factor graph (normal Factor graph) for the factorization in (5) is shown in Fig. 1, where the boxes labeled “=” are equality constraints [10], [11].

From (5), the partition function in (2) can be expressed as

$$Z = \sum_{\mathbf{x} \in \mathcal{X}^N} f(\mathbf{x}) \quad (6)$$

To estimate  $Z$ , we propose Monte Carlo methods in the dual of the Forney factor graph representing the factorization (5).

### III. THE DUAL MODEL

We can obtain the dual of Fig. 1, by replacing each variable  $x$  with its dual variable  $\tilde{x}$ , each factor  $\kappa_{k,\ell}$  with its 2D discrete Fourier transform (DFT), each factor  $\tau_m$  with its one-dimensional (1D) DFT, and each equality constraint with an XOR factor [11]–[14]. Note that  $\tilde{X}$  also takes on values in  $\mathcal{X}$ .

After suitable modifications, we can construct the dual Forney factor graph of the 2D Ising model, as shown in Fig. 2. For binary variables  $\tilde{x}_1, \tilde{x}_2, \dots, \tilde{x}_k$  boxes containing “+” symbols in Fig. 2, represent XOR factors as

$$g(\tilde{x}_1, \tilde{x}_2, \dots, \tilde{x}_k) = [\tilde{x}_1 \oplus \tilde{x}_2 \oplus \dots \oplus \tilde{x}_k = 0] \quad (7)$$

where  $\oplus$  denotes the sum in GF(2), the small boxes attached to each XOR factor are as

$$\lambda_m(\tilde{x}_m) = \begin{cases} \cosh H_m, & \text{if } \tilde{x}_m = 0 \\ -\sinh H_m, & \text{if } \tilde{x}_m = 1 \end{cases} \quad (8)$$

and the unlabeled normal-size boxes attached to each equality constraint represent factors as

$$\gamma_k(\tilde{x}_k) = \begin{cases} 2 \cosh J_k, & \text{if } \tilde{x}_k = 0 \\ 2 \sinh J_k, & \text{if } \tilde{x}_k = 1 \end{cases} \quad (9)$$

Here,  $J_k$  is the coupling parameter associated with each bond. For more details, see [1], [2].

In this paper, we focus on ferromagnetic models, and as a result, all the factors (9) are positive. In a 2D Ising model,

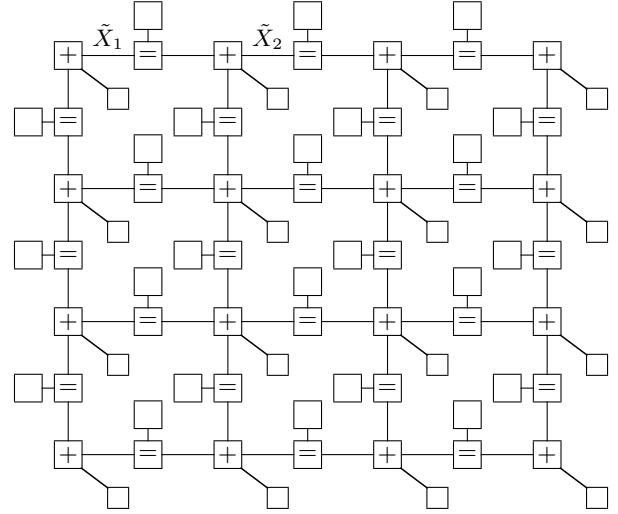

Fig. 2. Dual Forney factor graph of the 2D Ising model in an external field, where small boxes represent (8), unlabeled normal-size boxes represent (9), and boxes containing “+” symbols represent XOR factors, as in (7).

the value of  $Z$  is invariant under the change of sign of the external field [4]. Therefore, without loss of generality, we assume  $H_m < 0$  for  $1 \leq m \leq N$ . With this assumption, all the factors (8) will also be positive.

In the dual domain, we denote the partition function by  $Z_d$ . In the context of this paper, the normal factor graph duality theorem [13, Theorem 2] states that

$$Z_d = |\mathcal{X}|^N Z \quad (10)$$

Roughly speaking, the dual representation transforms the low-temperature region (i.e., large  $J$ ) to the high-temperature region (i.e., small  $J$ ) and vice versa. Furthermore, due to the presence of the XOR factors in Fig. 2, it is possible to simulate a subset of the variables, followed by doing computations on the remaining ones. These properties can be employed to design efficient Monte Carlo methods in the dual domain to estimate  $Z$  – especially for cases that such an estimation might otherwise be difficult in the original (primal) domain.

In Section IV, we design Monte Carlo methods in Fig. 2 to estimate  $Z_d$ , which can then be used to compute an estimate of  $Z$  via the normal factor graph duality theorem.

### IV. MONTE CARLO METHODS

We describe our Monte Carlo methods (importance sampling and uniform sampling) in the dual factor graph of the 2D Ising model in an external field.

In Fig. 2, let us partition  $\tilde{\mathbf{X}}$  into  $\tilde{\mathbf{X}}_A$  and  $\tilde{\mathbf{X}}_B$ , with the restriction that  $\tilde{\mathbf{X}}_B$  is a linear combination (involving the XOR factors) of  $\tilde{\mathbf{X}}_A$ . An example of such a partitioning is illustrated in Fig. 3, where  $\tilde{\mathbf{X}}_B$  is the set of all the edges connected to the small unlabeled boxes (which are involved in factors (8)), and  $\tilde{\mathbf{X}}_A$  is the set of all the bonds (which are involved in factors (9) and are marked by thick edges). As will be discussed, this choice of partitioning is appropriate for models in a strong external field.

In this set-up, a valid configuration  $\tilde{\mathbf{x}} = (\tilde{\mathbf{x}}_A, \tilde{\mathbf{x}}_B)$  in the dual factor graph can be created by assigning values to  $\tilde{\mathbf{X}}_A$ , followed by updating  $\tilde{\mathbf{X}}_B$  as a linear combination of  $\tilde{\mathbf{X}}_A$ .

Accordingly, let us define

$$\Gamma(\tilde{\mathbf{x}}_A) \triangleq \prod_{\tilde{x}_k \in \tilde{\mathbf{x}}_A} \gamma_k(\tilde{x}_k) \quad (11)$$

$$\Lambda(\tilde{\mathbf{x}}_B) \triangleq \prod_{\tilde{x}_m \in \tilde{\mathbf{x}}_B} \lambda_m(\tilde{x}_m) \quad (12)$$

From (11), we define the following probability mass function in  $\mathcal{X}^{|\mathcal{B}|}$

$$q(\tilde{\mathbf{x}}_A) \triangleq \frac{\Gamma(\tilde{\mathbf{x}}_A)}{Z_q}, \quad \forall \tilde{\mathbf{x}}_A \in \mathcal{X}^{|\mathcal{B}|} \quad (13)$$

The probability mass function (13) has two key properties. First, its partition function  $Z_q$  is analytically available as

$$Z_q = \sum_{\tilde{\mathbf{x}}_A} \Gamma(\tilde{\mathbf{x}}_A) \quad (14)$$

$$= \prod_{k \in \mathcal{B}} 2(\cosh J_k + \sinh J_k) \quad (15)$$

$$= 2^{|\mathcal{B}|} \exp\left(\sum_{k \in \mathcal{B}} J_k\right) \quad (16)$$

where  $|\mathcal{B}|$  denotes the cardinality of  $\mathcal{B}$ , which is equal to the number of bonds in the lattice (cf. Section II).

Second, it is straightforward to draw *independent* samples  $\tilde{\mathbf{x}}_A^{(1)}, \tilde{\mathbf{x}}_A^{(2)}, \dots, \tilde{\mathbf{x}}_A^{(\ell)}, \dots$ , according to  $q(\tilde{\mathbf{x}}_A)$ . The product form of (11) indicates that to draw  $\tilde{\mathbf{x}}_A^{(\ell)}$  we can do the following.

draw  $u_1^{(\ell)}, u_2^{(\ell)}, \dots, u_{|\mathcal{B}|}^{(\ell)} \stackrel{\text{i.i.d.}}{\sim} \mathcal{U}[0, 1]$

**for**  $k = 1$  **to**  $|\mathcal{B}|$

**if**  $u_k^{(\ell)} < \frac{1}{2}(1 + e^{-2J_k})$

$\tilde{x}_{A,k}^{(\ell)} = 0$

**else**

$\tilde{x}_{A,k}^{(\ell)} = 1$

**end if**

**end for**

The quantity  $\frac{1}{2}(1 + e^{-2J_k})$  is equal to  $\gamma_k(0)/(\gamma_k(0) + \gamma_k(1))$ .

As  $\tilde{\mathbf{x}}_B$  is a linear combination of  $\tilde{\mathbf{x}}_A$ , updating  $\tilde{\mathbf{x}}_B^{(\ell)}$  is easy after generating  $\tilde{\mathbf{x}}_A^{(\ell)}$ . These samples are then used in the following importance sampling algorithm to estimate  $Z_d$ .

**for**  $\ell = 1$  **to**  $L$

draw  $\mathbf{x}_A^{(\ell)}$  according to  $q(\tilde{\mathbf{x}}_A)$

update  $\tilde{\mathbf{x}}_B^{(\ell)}$

**end for**

compute

$$\hat{Z}_{\text{IS}} = \frac{Z_q}{L} \sum_{\ell=1}^L \Lambda(\tilde{\mathbf{x}}_B^{(\ell)}) \quad (17)$$

It follows that,  $\hat{Z}_{\text{IS}}$  is an unbiased estimator of  $Z_d$ . Indeed

$$\mathbb{E}[\hat{Z}_{\text{IS}}] = Z_d \quad (18)$$

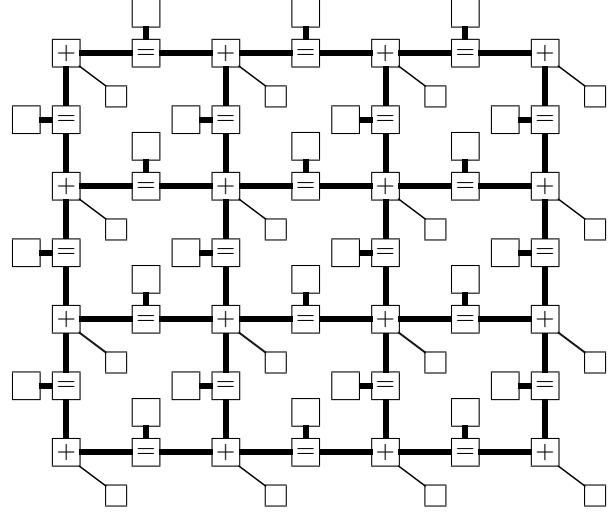

Fig. 3. A partitioning of the variables in Fig. 2. The thick edges (bonds) represent  $\tilde{\mathbf{X}}_A$  and edges connected to the unlabeled small boxes represent  $\tilde{\mathbf{X}}_B$ . Here,  $\tilde{\mathbf{X}}_B$  is a linear combination (involving XOR factors) of  $\tilde{\mathbf{X}}_A$ .

The proposed importance sampling scheme can yield an estimate of  $Z_d$ , which can then be used to estimate  $Z$  in (6), using the normal factor graph duality theorem (cf. Section III).

The accuracy of (17) depends on the fluctuations of  $\Lambda(\tilde{\mathbf{x}}_B)$ . If  $\Lambda(\tilde{\mathbf{x}}_B)$  varies smoothly,  $\hat{Z}_{\text{IS}}$  will have a small variance. With our choice of partitioning in (11) and (12), we expect to observe a small variance if the model is in a strong (negative) external field. See Appendix I for a discussion.

We can design a uniform sampling algorithm by drawing  $\mathbf{x}_A^{(\ell)}$  uniformly and independently from  $\mathcal{X}^{|\mathcal{B}|}$ , and by applying

$$\hat{Z}_{\text{Unif}} = \frac{|\mathcal{X}^{|\mathcal{B}|}}{L} \sum_{\ell=1}^L \Gamma(\tilde{\mathbf{x}}_A^{(\ell)}) \Lambda(\tilde{\mathbf{x}}_B^{(\ell)}) \quad (19)$$

It is easy to verify that,  $\mathbb{E}[\hat{Z}_{\text{Unif}}] = Z_d$ .

The efficiency of the uniform sampling and the importance sampling algorithms will be close if  $J_k$  is very large (i.e., when the model is at very low temperature). However, for a wider range of parameters, importance sampling outperforms uniform sampling – as will be illustrated in our numerical experiments in Section V.

If the model is in a relatively strong external field, we can consider applying annealed importance sampling [15]; see Appendix II. The choice of partitioning in the dual graph is arbitrary, as long as  $\tilde{\mathbf{x}}_B$  can be computed as linear combinations of  $\tilde{\mathbf{x}}_A$ . The partitioning in Fig. 3 is suitable for models in a strong external field. An example of a partitioning suitable for models with strong couplings is described in [16].

Finally, note that a good general strategy to reduce the variance of Monte Carlo methods in Fig. 2, is to include factors with larger model parameters (coupling parameters  $J$  and the external magnetic field  $H$ ) in  $\Lambda(\tilde{\mathbf{x}}_B)$ .

## V. NUMERICAL EXPERIMENTS

We apply the proposed Monte Carlo methods of Section IV to estimate the log partition function per site, i.e.,  $\frac{1}{N} \ln Z$ , of

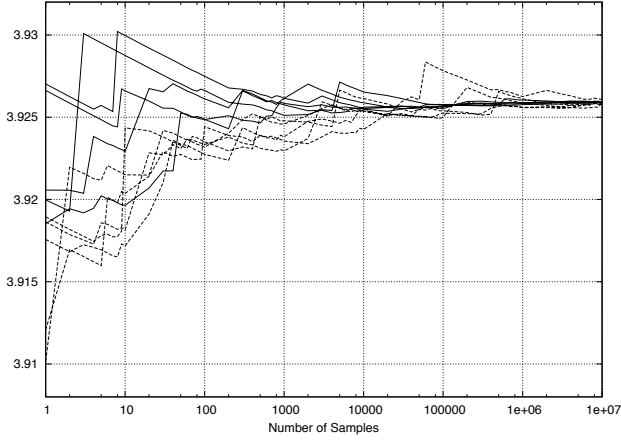

Fig. 4. Estimated  $\ln(Z)$  per site vs. the number of samples for a  $30 \times 30$  Ising model, with  $J \sim \mathcal{U}[1.3, 1.5]$  and  $H \sim \mathcal{U}[-1.25, -1.0]$ . The plot shows five different sample paths obtained from importance sampling (solid lines) and five different sample paths obtained from uniform sampling (dashed lines) in the dual factor graph.

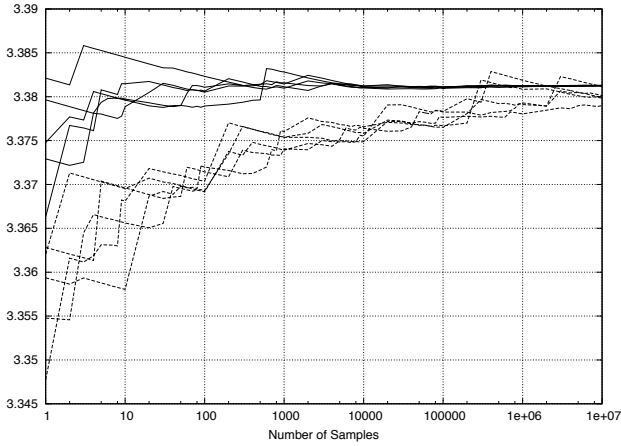

Fig. 5. Everything as in Fig. 4; but with  $J \sim \mathcal{U}[0.75, 1.5]$ .

the 2D ferromagnetic Ising model in an external field with spatially varying model parameters.

All simulation results show  $\frac{1}{N} \ln Z$  vs. the number of samples for one instance of the Ising model of size  $N = 30 \times 30$  and with periodic boundary conditions. In this case  $|\mathcal{B}| = 2N$ .

In our first two experiments we set  $H_m \stackrel{\text{i.i.d.}}{\sim} \mathcal{U}[-1.25, -1.0]$ . The coupling parameters are set to  $J_k \stackrel{\text{i.i.d.}}{\sim} \mathcal{U}[1.3, 1.5]$  in the first experiment and to  $J_k \stackrel{\text{i.i.d.}}{\sim} \mathcal{U}[0.75, 1.5]$  in the second experiment. Simulation results obtained from importance sampling (solid lines) and uniform sampling (dashed lines) are shown in Figs. 4 and 5. The estimated log partition functions per site are about 3.926 and 3.381, respectively.

For very large coupling parameters, (corresponding to models at very low temperature), convergence of uniform sampling is comparable to the convergence of the importance sampling algorithm (see Fig. 4). However, as we observe in Fig 5, uniform sampling has issues with slow convergence for a wider range of coupling parameters, while the importance sampling

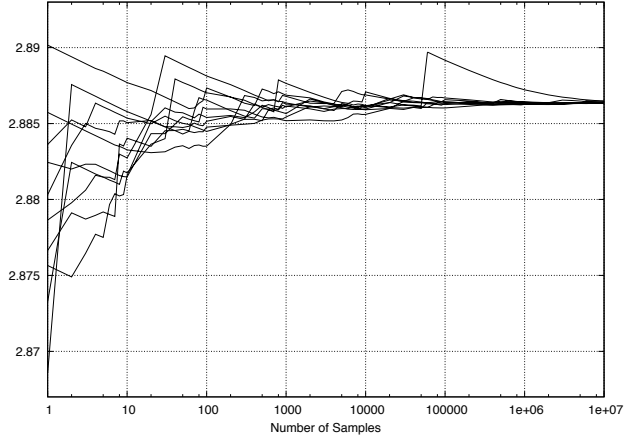

Fig. 6. Estimated  $\ln(Z)$  per site vs. the number of samples for a  $30 \times 30$  Ising model, with  $J \sim \mathcal{U}[0.25, 1.5]$  and  $H \sim \mathcal{U}[-1.25, -1.0]$ . The plot shows ten different sample paths obtained from importance sampling in the dual factor graph.

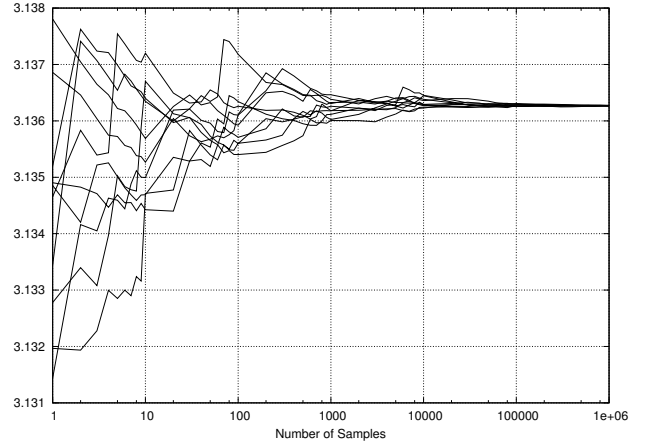

Fig. 7. Everything as in Fig. 6; but with  $H \sim \mathcal{U}[-1.5, -1.25]$ .

algorithm performs well in all the ranges.

In our last two experiments we set  $J_k \stackrel{\text{i.i.d.}}{\sim} \mathcal{U}[0.25, 1.5]$ . In the third experiment, we set  $H_m \stackrel{\text{i.i.d.}}{\sim} \mathcal{U}[-1.25, -1.0]$ . Fig. 6 shows simulation results obtained from importance sampling, where the estimated log partition function per site is about 2.886. We set  $H_m \stackrel{\text{i.i.d.}}{\sim} \mathcal{U}[-1.5, -1.25]$  in the last experiment. The estimated  $\frac{1}{N} \ln Z$  from Fig. 7 is about 3.1362. We observe that convergence of the importance sampling algorithm improves as  $|H|$  becomes larger (see Appendix I).

## VI. CONCLUSION

Monte Carlo methods were proposed in the dual Forney factor graph to estimate the partition function of the 2D ferromagnetic Ising model in an external magnetic field. We described a method to partition the variables in the dual factor graph and introduced an auxiliary probability mass function accordingly.

The methods can efficiently estimate the partition function in a wide range of model parameters; in particular (with our

choice of partitioning), when the Ising model is in a strong external magnetic field. Indeed, convergence of the methods improve as the external field becomes stronger. Depending on the values and the spatial distribution of the model parameters, different partitionings yield schemes with different convergence properties. Generalizations of the proposed methods to the  $q$ -state Potts model are discussed in [17, Section V]. Comparisons with deterministic algorithms in the primal domain (e.g., the generalized belief propagation and the tree expectation propagation algorithms, as done in [18]) are left for future work.

#### ACKNOWLEDGEMENTS

The author would like to thank Hans-Andrea Loeliger, Pascal Vontobel, David Forney, Justin Dauwels, and Ali Al-Bashabsheh for their comments that greatly improved the presentation of this paper. The author gratefully acknowledges the support of Albert Guillén i Fàbregas at UPF.

#### APPENDIX I

##### CONVERGENCE OF MONTE CARLO METHODS IN THE DUAL FORNEY FACTOR GRAPH

For simplicity, we assume that the coupling parameter and the external field are both constant, denoted by  $J$  and  $|H|$ , respectively. In the dual factor graph, let us replace each factor (10) by

$$\lambda(\tilde{x}_m) = (\tanh |H|)^{\tilde{x}_m} \quad (20)$$

and each factor (12) by

$$\gamma(\tilde{x}_k) = (\tanh J)^{\tilde{x}_k} \quad (21)$$

The required scale factor  $S$  to recover  $Z_d$  can be easily computed by multiplying all the local scale factors as

$$S = (2 \cosh J)^{|\mathcal{B}|} (\cosh |H|)^N \quad (22)$$

Note that,  $\lim_{t \rightarrow \infty} \tanh t = 1$ , therefore in a strong external field (i.e., large  $|H|$ ) and at low temperature (i.e., large  $J$ ),  $\tanh |H|$  and  $\tanh J$  both tend to constant, which gives reasons for the fast convergence of uniform sampling in this case. Indeed, convergence of the uniform sampling algorithm in the dual domain improves as  $J$  and  $|H|$  both become larger. And for a fixed  $J$ , convergence of the importance sampling algorithm improves as  $|H|$  becomes larger. For more details, see [17, Appendix I].

#### APPENDIX II

##### ANNEALED IMPORTANCE SAMPLING IN THE DUAL FORNEY FACTOR GRAPH

We briefly explain how to employ annealed importance sampling [15] in the dual factor graph to estimate the partition function of the 2D Ising model, when the model is in a relatively strong consistent external field.

Again, for simplicity, we assume that the coupling parameter and the external field are both constant. The partition function is thus denoted by  $Z_d(J, |H|)$ . We express  $Z_d(J, |H|)$

using a sequence of intermediate partition functions by varying  $|H|$  in  $V$  levels as

$$Z_d(J, |H|) = Z_d(J, |H|^{\alpha_V}) \prod_{v=0}^{V-1} \frac{Z_d(J, |H|^{\alpha_{v+1}})}{Z_d(J, |H|^{\alpha_v})} \quad (23)$$

Here, unlike typical annealing strategies applied in the original domain,  $(\alpha_0, \alpha_1, \dots, \alpha_V)$  is an increasing sequence, with  $1 = \alpha_0 < \alpha_1 < \dots < \alpha_V$ .

If  $\alpha_V$  is large enough,  $Z_d(J, |H|^{\alpha_V})$  can be estimated efficiently via our proposed Monte Carlo methods. As for the intermediate steps, a sampling technique that leaves the target distribution invariant (e.g., Metropolis-Hastings algorithms or Gibbs sampling [6]) is required at each level. The number of levels  $V$  should be sufficiently large to ensure that intermediate target distributions are close enough and estimating  $Z_d(J, |H|^{\alpha_V})$  is feasible (see also [19, Section 3]).

#### REFERENCES

- [1] M. Molkaraie and H.-A. Loeliger, "Partition function of the Ising model via factor graph duality," *Proc. 2013 IEEE Int. Symp. on Information Theory*, Istanbul, Turkey, July 7–12, 2013, pp. 2304–2308.
- [2] A. Al-Bashabsheh and Y. Mao, "On stochastic estimation of the partition function," *Proc. 2014 IEEE Int. Symp. on Information Theory*, Honolulu, USA, June 29 – July 4, 2014, pp. 1504–1508.
- [3] L. Onsager, "Crystal statistics. I. A two-dimensional model with an order-disorder transition," *Phys. Rev.*, vol. 65, pp. 117–149, Feb. 1944.
- [4] R. J. Baxter, *Exactly Solved Models in Statistical Mechanics*. Dover Publications, 2007.
- [5] D. J. A. Welsh, "The computational complexity of some classical problems from statistical physics," *Disorder in phys. systems*, vol. 307, 1990.
- [6] R. M. Neal, *Probabilistic Inference Using Markov Chain Monte Carlo Methods*. Techn. Report CRG-TR-93-1, Dept. Computer Science, Univ. of Toronto, Sept. 1993.
- [7] K. Binder and D. W. Heermann, *Monte Carlo Simulation in Statistical Physics*. Springer, 2010.
- [8] M. Molkaraie and H.-A. Loeliger, "Monte Carlo algorithms for the partition function and information rates of two-dimensional channels," *IEEE Trans. Information Theory*, vol. 59, pp. 495–503, Jan. 2013.
- [9] R. L. Graham, D. E. Knuth, and O. Patashnik, *Concrete Mathematics: A Foundation for Computer Science*. Addison-Wesley, 1989.
- [10] H.-A. Loeliger, "An introduction to factor graphs," *IEEE Signal Proc. Mag.*, vol. 29, pp. 28–41, Jan. 2004.
- [11] G. D. Forney, Jr., "Codes on graphs: normal realization," *IEEE Trans. Information Theory*, vol. 47, pp. 520–548, Feb. 2001.
- [12] G. D. Forney, Jr., "Codes on graphs: duality and MacWilliams identities," *IEEE Trans. Information Theory*, vol. 57, pp. 1382–1397, Feb. 2011.
- [13] A. Al-Bashabsheh and Y. Mao, "Normal factor graphs and holographic transformations," *IEEE Trans. Information Theory*, vol. 57, pp. 752–763, Feb. 2011.
- [14] G. D. Forney, Jr. and P. O. Vontobel, "Partition functions of normal factor graphs," *2011 Information Theory and Applications Workshop*, La Jolla, USA, Feb. 6–11, 2011.
- [15] R. M. Neal, "Annealed importance sampling," *Statistics and Computing*, vol. 11, pp. 125–139, 2001.
- [16] M. Molkaraie, "An importance sampling scheme on dual factor graphs. II. models with strong couplings," arXiv:1404.5666 [stat.CO], 2014.
- [17] M. Molkaraie, "An importance sampling scheme on dual factor graphs. I. models in a strong external field," arXiv:1401.4912 [stat.CO], 2014.
- [18] V. Gómez, H. J. Kappen, and M. Chertkov "Approximate inference on planar graphs using loop calculus and belief propagation," *J. Machine Learning Res.*, vol. 11, pp. 1273–1296, Aug. 2010.
- [19] R. Salakhutdinov and I. Murray, "On the quantitative analysis of deep belief networks," *Proc. 25th Int. Conf. on Machine Learning*, Helsinki, Finland, July 5–9, 2008, pp. 872–879.