

Some Reference Formulas For The Generating Functions Of Canonical Transformations

Damiano Anselmi

*Dipartimento di Fisica “Enrico Fermi”, Università di Pisa,
and INFN, Sezione di Pisa,
Largo B. Pontecorvo 3, 56127 Pisa, Italy*

damiano.anselmi@unipi.it

Abstract

We study some properties of the canonical transformations in classical mechanics and quantum field theory and give a number of practical formulas concerning their generating functions. First, we give a diagrammatic formula for the perturbative expansion of the composition law around the identity map. Then we propose a standard way to express the generating function of a canonical transformation by means of a certain “componential” map, which obeys the Baker-Campbell-Hausdorff formula. We derive the diagrammatic interpretation of the componential map, work out its relation with the solution of the Hamilton-Jacobi equation and derive its time-ordered version. Finally, we generalize the results to the Batalin-Vilkovisky formalism, where the conjugate variables may have both bosonic and fermionic statistics, and describe applications to quantum field theory.

1 Introduction

Canonical transformations have a variety of applications, from classical mechanics to quantum field theory. In particular, they play an important role when quantum field theory is formulated by means of the functional integral and the Batalin-Vilkovisky (BV) formalism [1, 2]. The BV formalism associates external sources K_α with the fields Φ^α and introduces a notion of *antiparentheses* (X, Y) of functionals X, Y of Φ and K . This formal setup is convenient to treat general gauge theories and study their renormalization, because it collects the Ward-Takahashi-Slavnov-Taylor (WTST) identities [3] in a compact form and relates in a simple way the identities satisfied by the classical action $S(\Phi, K)$ to the identities satisfied by the generating functional Γ of the one-particle irreducible correlation functions. The canonical transformations, which are the field/source redefinitions that preserve the antiparentheses, appear in several contexts. For example, they provide simple ways to gauge fix the theory and map the WTST identities under arbitrary changes of field variables and gauge fixing. Moreover, they are a key ingredient of the subtraction of divergences.

The generating functionals of the canonical transformations used in quantum field theory are often polynomial, and can be composed and inverted with a small effort. Nevertheless, there are exceptions. When the theory is nonrenormalizable, for example, as the standard model coupled to quantum gravity, the canonical transformations involved in the subtraction of the divergences are nonpolynomial and arbitrarily complicated. Even when the theory is power counting renormalizable, the variety of fields and sources that are present and their statistics make it useful to have some shortcuts and practical formulas to handle the basic operations on canonical transformations in more straightforward ways.

In this paper, we collect a number of reference formulas concerning the generating functions of canonical transformations and give diagrammatic interpretations of their perturbative versions. We first work in classical mechanics and then generalize the investigation to the BV formalism. The generalization is actually straightforward, since the operations we define preserve the statistics of the functionals.

In section 2 we start from the composition law, by writing the generating function of the composed canonical transformation as the tree-level projection of a suitable functional integral. So doing, the perturbative expansion of the result around the identity map can easily be expressed in a diagrammatic form. In section 3 we relate the composition law to the Baker-Campbell-Hausdorff (BCH) formula [4]. We propose a standard way of expressing the generating function of a canonical transformation by means of a *componential map* $\mathcal{C}(X)$ such that $\mathcal{C}^{-1}(X) = \mathcal{C}(-X)$ and $\mathcal{C}^{-1}(\mathcal{C}(X) \circ \mathcal{C}(Y)) = \text{BCH}(X, Y)$. In section 4 we derive the relation between the componential map and the solution of the Hamilton-Jacobi equation for time-independent Hamiltonians. In section 5 we work out the diagrammatic interpretation of the perturbative expansion of the componential map around the identity map. In section 6 we generalize the formulas to time-dependent Hamiltonians,

which gives the time-ordered version of the exponential map. In section 7 we extend the analysis to the BV formalism, where the fields can have arbitrary statistics. We illustrate a number of applications to quantum field theory. Section 8 contains the conclusions.

2 Composition of canonical transformations

In this section we study the composition of canonical transformations. We first recall the basic formulas for the generating function of the composite canonical transformation, in terms of the generating functions of the components. Then we express the result as the tree-level sector of a functional integral and provide a diagrammatic interpretation of its perturbative expansion around the identity map.

Consider two canonical transformations $q_1, p_1 \rightarrow q_2, p_2$ and $q_2, p_2 \rightarrow q_3, p_3$, with generating functions $F_{12}(q_1, p_2)$ and $F_{23}(q_2, p_3)$, respectively. It is known that the generating function of the composite canonical transformation $q_1, p_1 \rightarrow q_3, p_3$ is

$$F_{13}(q_1, p_3) = F_{12}(q_1, p_2) + F_{23}(q_2, p_3) - q_2^i p_2^i, \quad (2.1)$$

where q_2^i and p_2^i are the functions of q_1, p_3 that extremize the right-hand side.¹

The proof is straightforward. Extremizing the right-hand side with respect to q_2^i and p_2^i , we obtain

$$0 = \frac{\partial F_{12}}{\partial p_2^i} - q_2^i, \quad 0 = \frac{\partial F_{23}}{\partial q_2^i} - p_2^i.$$

Thanks to these equations, the derivatives of F_{13} with respect to q_1^i and p_3^i can be worked out by keeping q_2^j and p_2^j constant. This gives the relations

$$\frac{\partial F_{13}}{\partial q_1^i} = \frac{\partial F_{12}}{\partial q_1^i} = p_1^i, \quad \frac{\partial F_{13}}{\partial p_3^i} = \frac{\partial F_{23}}{\partial p_3^i} = q_3^i,$$

which prove that $F_{13}(q_1, p_3)$ is indeed the generating function of the canonical transformation $q_1, p_1 \rightarrow q_3, p_3$.

We write the composition law as

$$F_{13} = F_{23} \circ F_{12}, \quad (2.2)$$

in the sense the F_{12} is the transformation performed first and F_{23} is the one performed last. In particular, given a scalar function $S_1(q_1, p_1) = S_2(q_2, p_2) = S_3(q_3, p_3)$, we write

$$S_2 = F_{12} \circ S_1, \quad S_3 = F_{23} \circ S_2 = F_{23} \circ F_{12} \circ S_1 = F_{13} \circ S_1.$$

¹To our knowledge, very few textbooks report this property. One is ref. [5], where it is ascribed to Hamilton. For a standard derivation, see also [6]. For a derivation from the semiclassical limit of quantum mechanics, see [7]. For elaborations from the point of view of symplectic groupoids, see [8].

These formulas mean $S_2(q_2, p_2) = S_1(q_1(q_2, p_2), p_1(q_2, p_2))$, etc.

If we describe the canonical transformations $q_1, p_1 \rightarrow q_2, p_2$ and $q_2, p_2 \rightarrow q_3, p_3$ by means of generating functions $G_{12}(q_1, q_2)$ and $G_{23}(q_2, q_3)$, then, following similar steps, it is easy to prove that the composition is generated by

$$G_{13}(q_1, q_3) = G_{12}(q_1, q_2) + G_{23}(q_2, q_3), \quad (2.3)$$

where q_2 is the function of q_1, q_3 that extremizes the right-hand side.

In this paper, we are mostly interested in formulas that may have practical uses in perturbative quantum field theory. It is more convenient to describe the canonical transformations $q, p \rightarrow Q, P$ by means of generating functions of the form $F(q, P)$, rather than $G(q, Q)$, because the former can easily be expanded around the identity transformation and allow us to express the composite canonical transformation diagrammatically. It is not possible to achieve these goals in a simple way with generating functions of the form $G(q, Q)$.

To study the expansion around the identity map, write the generating functions F_{12} and F_{23} as

$$F_A(q, P) = q^i P^i + A(q, P), \quad F_B(q, P) = q^i P^i + B(q, P), \quad (2.4)$$

respectively, and their composition F_{13} as

$$F_C(q, P) = q^i P^i + C(q, P), \quad F_C = F_B \circ F_A. \quad (2.5)$$

Below we show that the solution $C(q, P)$ can be written as the tree-level sector of a zero-dimensional functional integral. Thanks to this, the diagrams that contribute to it can easily be built, according to the following rules. (a) The diagrams, made of lines and vertices, are connected and contain no loops. (b) The vertices are of two types, denoted by u and v , and can have arbitrary numbers of legs. (c) Each line of the diagram must connect one vertex of type u with one vertex of type v .

By definition, we include the diagrams that have no lines, that is to say the vertex u and the vertex v . The number of vertices is called *order* of the diagram. The absence of loops implies that a diagram of order n contains $n - 1$ lines, with $n \geq 1$. Note that there are no external legs.

Denote the diagrams of order n by $G_{n\alpha}$, where $\alpha = 1, \dots, r_n$ is an index that labels them. Call $f_{n\alpha}$ the combinatorial factor of $G_{n\alpha}$, which can be calculated with the usual rules, by viewing $G_{n\alpha}$ as a Feynman diagram. Associate a function $C_{n\alpha}(q, P)$ with $G_{n\alpha}$ by replacing each vertex u with the function $A(q, P)$, each vertex v with the function $B(q, P)$ and each line with the operator

$$\overleftarrow{\partial} \overrightarrow{\partial} \frac{1}{\partial q^i \partial P^i}, \quad (2.6)$$

where the P derivative acts on the function A attached to the line and the q derivative acts on the function B attached to the line. We call (2.6) the *propagator*.

Then the formula of the function $C(q, P)$ is

$$C(q, P) = \sum_{n=1}^{\infty} C^{(n)}(q, P), \quad C^{(n)}(q, P) = \sum_{\alpha=1}^{r_n} f_{n\alpha} C_{n\alpha}(q, P). \quad (2.7)$$

To prove this result, consider the auxiliary Lagrangian

$$\mathcal{L}(\phi, \psi, q, P) = A(q, P + \phi) + B(q + \psi, P) - \psi\phi$$

and the zero-dimensional quantum field theory described by \mathcal{L} , where ϕ^i are ψ^i are the “fields”. We focus on the generating function $W(q, P)$ defined by

$$e^{W(q, P)} = \int [d\phi d\psi] e^{\mathcal{L}(\phi, \psi, q, P)}.$$

The square brackets around the measure mean that we consider this integral as a functional integral, rather than an ordinary one. In other words, we view it as a bookkeeping for generating diagrams and making standard operations on diagrams.

The propagator of this theory is determined by the last term of \mathcal{L} , that is to say $-\psi\phi$, so it is equal to 1. Applying the standard Feynman rules, it is easy to check that the diagrams defined above give the tree sector of $W(q, P)$. Clearly, that sector is equal to the Legendre transform of $\mathcal{L}(\phi, \psi, q, P)$ with respect to ϕ and ψ , calculated in zero. Precisely, setting

$$0 = \frac{\partial \mathcal{L}}{\partial \phi^i} = \frac{\partial A}{\partial P^i}(q, P + \phi) - \psi^i, \quad 0 = \frac{\partial \mathcal{L}}{\partial \psi^i} = \frac{\partial B}{\partial q^i}(q + \psi, P) - \phi^i, \quad (2.8)$$

and denoting the solutions of these conditions by $\phi_*(q, P)$, $\psi_*(q, P)$, we find

$$\mathcal{L}(\phi_*, \psi_*, q, P) = A(q, P + \phi_*) + B(q + \psi_*, P) - \psi_*\phi_*. \quad (2.9)$$

Now, identify q with q_1 and P with p_3 . Working out q_2 and p_2 from the canonical transformations generated by $F_A(q_1, p_2)$ and $F_B(q_2, p_3)$, given in (2.4), it is easy to check that

$$p_2^i - p_3^i = \frac{\partial B}{\partial q_2^i}(q_2, p_3), \quad q_2^i - q_1^i = \frac{\partial A}{\partial p_2^i}(q_1, p_2). \quad (2.10)$$

On the other hand, formulas (2.8) give

$$\phi_*^i = \frac{\partial B}{\partial q_1^i}(q_1 + \psi_*, p_3), \quad \psi_*^i = \frac{\partial A}{\partial p_3^i}(q_1, p_3 + \phi_*). \quad (2.11)$$

Expanding (2.10) and (2.11) in powers of A and B and comparing the two outcomes, we get the equalities

$$\phi_*^i = p_2^i - p_3^i, \quad \psi_*^i = q_2^i - q_1^i. \quad (2.12)$$

Then using (2.1), (2.4) and (2.5), formula (2.9) gives

$$\mathcal{L}(\phi_*, \psi_*, q_1, p_3) = A(q_1, p_2) + B(q_2, p_3) - (q_2^i - q_1^i)(p_2^i - p_3^i) = C(q_1, p_3).$$

We conclude that $C(q, P)$ coincides with $\mathcal{L}(\phi_*, \psi_*, q, P)$ and is given by the diagrams listed above, which proves (2.7). We can write

$$e^{C(q, P)} = \int' [d\phi d\psi] e^{A(q, P + \phi) + B(q + \psi, P) - \psi\phi}, \quad (2.13)$$

where the prime on the integral sign means that only the tree contributions are kept.

For example, the lowest order diagrams contributing to formula (2.7) are

$$(2.14)$$

More explicitly,

$$\begin{aligned} C = & A + B + A_i B^i + \frac{1}{2} A_i B^{ij} A_j + \frac{1}{2} B^i A_{ij} B^j + \frac{1}{3!} A_i A_j A_k B^{ijk} + A_i B^{ij} A_{jk} B^k + \frac{1}{3!} B^i B^j B^k A_{ijk} \\ & + \frac{1}{4!} A_i A_j A_k A_l B^{ijkl} + \frac{1}{2} A_i B^{ij} A_{jk} B^{kl} A_l + \frac{1}{2} A_i A_j A_{kl} B^{ijk} B^l \\ & + \frac{1}{2} B^i B^j B^{kl} A_{ijk} A_l + \frac{1}{2} B^i A_{ij} B^{jk} A_{kl} B^l + \frac{1}{4!} B^i B^j B^k B^l A_{ijkl} + \dots, \end{aligned} \quad (2.15)$$

where

$$A_{i_1 \dots i_n} = \frac{\partial^n A(q, P)}{\partial P_{i_1} \dots \partial P_{i_n}}, \quad B^{i_1 \dots i_n} = \frac{\partial^n B(q, P)}{\partial q_{i_1} \dots \partial q_{i_n}}.$$

A simple case is when $A(q, P) = u(q) + f^i(q) P^i$ for some functions $u(q)$ and $f^i(q)$. Then the diagrams give a Taylor expansion that can easily be resummed into

$$C(q, P) = A(q, P) + B(q^i + f^i(q), P). \quad (2.16)$$

Similarly, $B(q, P) = v(P) + q^i g^i(P)$ gives

$$C(q, P) = A(q, P^i + g^i(P)) + B(q, P). \quad (2.17)$$

Another simple case is when $B(q, P) = w B'(q, P)$, where w is a constant parameter that squares to zero, to make the first order of the Taylor expansion exact. For example, we can take $w = \varpi \varpi'$, where ϖ and ϖ' are constant and anticommuting. We find

$$C(q, P) = A(q, P) + B\left(q + \frac{\partial A}{\partial P}, P\right).$$

Similarly, if $A(q, P) = wA'(q, P)$ we have

$$C(q, P) = A\left(q, P + \frac{\partial B}{\partial q}\right) + B(q, P).$$

One may wonder if there is a relation between the composition formula (2.7) and the Baker-Campbell-Hausdorff formula. It turns out that the formula (2.7) is a sort of “primitive” of the BCH formula. The next section better clarifies this concept.

3 The componential map

The composition law of the previous section is good for a number of purposes, but not practical in other cases. For example, it does not provide a simple way to invert a canonical transformation. In this section, we propose a standard way of expressing the generating function of a canonical transformation by means of a “componential” map and rephrase the composition law in a way that makes various properties more apparent. The componential map is written as a perturbative expansion around the identity map and obeys the BCH formula. Among other things, it makes the inverse operation straightforward.

Let \mathcal{A} denote the space of C^∞ functions X, Y, \dots on phase space. Let $\{X, Y\}$ denote the Poisson brackets of X and Y , and $\text{ad}(X) : \mathcal{A} \rightarrow \mathcal{A}$, $Y \mapsto \text{ad}(X)Y = \{X, Y\}$ denote the adjoint map. Write the BCH formula as

$$e^{\text{ad}(X)}e^{\text{ad}(Y)} = e^{\text{ad}(X+Y+X\Delta Y)}, \quad (3.1)$$

where

$$X\Delta Y \equiv \frac{1}{2}\{X, Y\} + \frac{1}{12}(\{X, \{X, Y\}\} + \{Y, \{Y, X\}\}) + \dots$$

The composition law (2.2) of the previous section defines a map

$$\circ : \mathcal{A} \times \mathcal{A} \rightarrow \mathcal{A}, \quad F_{12}, F_{23} \mapsto F_{13} = F_{23} \circ F_{12}.$$

The componential map is a map $\mathcal{C} : \mathcal{A} \rightarrow \mathcal{A}$, $X \mapsto \mathcal{C}(X)$, such that $\mathcal{C}(0) = I$ and

$$\mathcal{C}(X) \circ \mathcal{C}(Y) = \mathcal{C}(X + Y + X\Delta Y). \quad (3.2)$$

We call it componential map, because it is determined by the composition law, as we prove below. Note that (3.2) implies that the inverse of $\mathcal{C}(X)$ is just $\mathcal{C}(-X)$.

Basically, we regard (3.2) as an equation for the unknown \mathcal{C} . To better appreciate what we are doing, consider

$$E(M)E(N) = E(M + N + M \times N)$$

as an equation for the unknown map E , where M and N are square matrices of some order, the left-hand side is the matrix product of $E(M)$ and $E(N)$ and $M \times N$ is the same as $M\Delta N$ with

Poisson brackets replaced by commutators. We know that the solution of this problem is the exponential of the matrix, i.e. $E(M) = e^M$. The exponential map $e^{\text{ad}(X)}$ can also be seen as the solution $\mathcal{E}(X)$ of the equation

$$\mathcal{E}(X)\mathcal{E}(Y) = \mathcal{E}(X + Y + X\Delta Y), \quad (3.3)$$

where $\mathcal{E}(X)$ and $\mathcal{E}(Y)$ are operators $\mathcal{A} \rightarrow \mathcal{A}$, and the left-hand side is their product. Similarly, the componential map is the solution of (3.3) if $\mathcal{E}(X)$ and $\mathcal{E}(Y)$ are viewed as the generating functions of some canonical transformations and the right-hand side is the generating function of their composition.

We expand $\mathcal{C}(X)$ as

$$\mathcal{C}(X) = I + c(X) = I + \sum_{n=1}^{\infty} c_n(X), \quad (3.4)$$

where I denotes the identity map, $c_1 = X$ and $c_n(X)$, $n \geq 2$, are homogeneous functions of degree n in X and its derivatives. When we need to make the arguments of the various functions explicit, we denote them by q, P . Then $I(q, P) = q^i P^i$ is the generating function of the identity canonical transformation, while the functions X , $\mathcal{C}(X)$, $c(X)$, $c_n(X)$ are written as $X(q, P)$, $\mathcal{C}(X(q, P))$, $c(X(q, P))$ and $c_n(X(q, P))$, respectively. Note that the Poisson brackets involved in the Δ operation of formula (3.2) are calculated with respect to the ‘‘mixed’’ variables q, P .

Now we prove that the functions $c_n(X(q, P))$, $n > 1$, are recursively determined by the formula

$$c_n(X(q, P)) = \frac{1}{n!} \frac{d^{n-1}}{d\xi^{n-1}} X \left(q^i, P^j + \sum_{k=1}^{n-1} \xi^k \frac{\partial}{\partial q^j} c_k(X(q, P)) \right) \Big|_{\xi=0}. \quad (3.5)$$

To achieve this goal, we apply the composition law (3.2) in the particular case where X and Y are proportional to each other, so that $X\Delta Y = 0$. If σ and τ are arbitrary constants, we have $\mathcal{C}(\sigma X) \circ \mathcal{C}(\tau X) = \mathcal{C}((\sigma + \tau)X)$. From formulas (2.9) and (3.4), we get

$$\sum_{n=1}^{\infty} (\sigma + \tau)^n c_n(X(q, P)) = \sum_{n=1}^{\infty} [\tau^n c_n(X(q, P + \phi)) + \sigma^n c_n(X(q + \psi, P))] - \psi^i \phi^i,$$

upon extremization with respect to ϕ and ψ . We differentiate this equation with respect to τ and then set $\tau = 0$. Because of the extremization, we can keep ϕ and ψ constant. The result is

$$\sum_{n=1}^{\infty} n \sigma^{n-1} c_n(X(q, P)) = X \left(q, P^i + \sum_{n=1}^{\infty} \sigma^n \frac{\partial}{\partial q^i} c_n(X(q, P)) \right), \quad (3.6)$$

having noted that

$$\phi^i = \sum_{n=1}^{\infty} \sigma^n \frac{\partial}{\partial q^i} c_n(X(q, P)), \quad \psi^i = 0,$$

at $\tau = 0$. Differentiating formula (3.6) $n - 1$ times with respect to σ and setting $\sigma = 0$ later on, we get (3.5).

The first orders are

$$\begin{aligned}
\mathcal{C}(X) &= I + X + \frac{1}{2}X_iX^i + \frac{1}{3!}(X_{ij}X^iX^j + X^jX_j^iX_i + X^{ij}X_iX_j) \\
&+ \frac{1}{4!}\left(X_iX_j^iX_k^jX^k + 3X_iX_j^iX^{jk}X_k + 3X^iX_{ij}X_k^jX^k + 5X^iX_{ij}X^{jk}X_k\right) \\
&+ \frac{1}{4!}\left(X_{ijk}X^iX^jX^k + X_iX_{jk}^iX^jX^k + X_iX_jX_k^{ij}X^k + X_iX_jX_kX^{ijk}\right) + \dots,
\end{aligned} \tag{3.7}$$

where

$$X_{j_i \dots j_m}^{i_1 \dots i_n} \equiv \frac{\partial^{n+m} X(q, P)}{\partial q^{i_1} \dots \partial q^{i_n} \partial P^{j_1} \dots \partial P^{j_m}}.$$

4 Relation with the solution of the Hamilton-Jacobi equation

As promised, the componential map is uniquely determined by the composition law. However, we still have to prove that formula (3.2) holds for arbitrary X and Y . This goal can be achieved by working out the relation between the componential map and the solution of the Hamilton-Jacobi equation.

Rescale X by a factor η . Recalling that the function c_n is homogeneous of degree n , formulas (3.4) and (3.5) give

$$\mathcal{C}(\eta X(q, P)) = q^i P^i + \sum_{n=1}^{\infty} \eta^n c_n(X(q, P)) = q^i P^i + \sum_{n=1}^{\infty} \frac{\eta^n}{n!} \frac{d^{n-1}}{d\xi^{n-1}} X\left(q^i, \frac{\partial}{\partial q^j} \mathcal{C}(\xi X(q, P))\right) \Big|_{\xi=0}.$$

This is just the solution of the Hamilton-Jacobi equation

$$\frac{\partial}{\partial \eta} \mathcal{C}(\eta X(q, P)) = X\left(q^i, \frac{\partial}{\partial q^j} \mathcal{C}(\eta X(q, P))\right) \tag{4.1}$$

with the initial condition $\mathcal{C}(0) = I$. To map formula (4.1) into the usual form of the Hamilton-Jacobi equation, it is sufficient to imagine that η is minus the time t , the function $X(q, p)$ is a (time-independent) Hamiltonian $H(q, p)$ and the componential map \mathcal{C} is the action S :

$$\frac{\partial S}{\partial t} + H\left(q, \frac{\partial S}{\partial q}\right) = 0.$$

Conversely, given a mechanical system described by the time-independent Hamiltonian $H(q, p)$, the function

$$\mathcal{C}(-tH(q, P)) = q^i P^i + \sum_{n=1}^{\infty} (-t)^n c_n(H(q, P)) \tag{4.2}$$

is the generating function of the canonical transformation that performs the time evolution from time t to time zero.

The corresponding Hamilton equations

$$\frac{dp^i}{dt} = -\{H(q, p), p^i\} = -\text{ad}(H(q, p))p^i, \quad \frac{dq^i}{dt} = -\{H(q, p), q^i\} = -\text{ad}(H(q, p))q^i, \tag{4.3}$$

are solved by the exponential map

$$Q^i = e^{t\text{ad}(H(q,p))} q^i, \quad P^i = e^{t\text{ad}(H(q,p))} p^i. \quad (4.4)$$

Indeed, the solution (4.2) of the Hamilton-Jacobi equation is the generating function of the canonical transformation that maps $q^i(t), p^i(t)$ to the initial conditions Q^i, P^i , because it makes the transformed Hamiltonian vanish. Clearly, (4.3) and (4.4) imply $dQ^i/dt = dP^i/dt = 0$. For future reference, we recall that the Hamilton equations imply

$$f(Q, P) = e^{t\text{ad}(H(q,p))} f(q, p), \quad (4.5)$$

for an arbitrary function $f \in \mathcal{A}$. Indeed, (4.5) solves $df(Q, P)/dt = 0$ and is obviously correct at $t = 0$.

Thus, the transformations generated by $\mathcal{C}(X(q, P))$ are

$$\begin{pmatrix} Q^i \\ P^i \end{pmatrix} = e^{-\text{ad}(X(q,p))} \begin{pmatrix} q^i \\ p^i \end{pmatrix}. \quad (4.6)$$

Since the exponential map satisfies the BCH formula (3.1), we can easily prove that the compositional map satisfies the BCH formula (3.2), for arbitrary functions X and Y .

To see this, let us write the transformations generated by $\mathcal{C}(Y(q_1, p_2))$ and $\mathcal{C}(X(q_2, p_3))$:

$$\begin{pmatrix} q_3^i \\ p_3^i \end{pmatrix} = e^{-\text{ad}(X(q_2,p_2))} \begin{pmatrix} q_2^i \\ p_2^i \end{pmatrix}, \quad \begin{pmatrix} q_2^i \\ p_2^i \end{pmatrix} = e^{-\text{ad}(Y(q_1,p_1))} \begin{pmatrix} q_1^i \\ p_1^i \end{pmatrix}. \quad (4.7)$$

Because of (2.2), the transformations due to $(\mathcal{C}(X) \circ \mathcal{C}(Y))(q_1, p_3)$ are then

$$\begin{pmatrix} q_3^i \\ p_3^i \end{pmatrix} = e^{-\text{ad}(X(q_2,p_2))} e^{-\text{ad}(Y(q_1,p_1))} \begin{pmatrix} q_1^i \\ p_1^i \end{pmatrix}. \quad (4.8)$$

Note that the functions X and Y have different arguments in this formula. To finalize the composition, we must convert q_2, p_2 into q_1, p_1 inside $X(q_2, p_2)$. Obviously, the variables used to calculate the Poisson brackets do not need to be specified, because the transformations are canonical. In particular, we do not need to specify the variables in the brackets of the adjoint maps. However, the arguments of X and Y are crucial, which is why we have written them explicitly starting from formula (4.6).

We have

$$X(q_2, p_2) = e^{-\text{ad}(Y(q_1,p_1))} X(q_1, p_1), \quad e^{-\text{ad}(X(q_2,p_2))} = e^{-\text{ad}(Y(q_1,p_1))} e^{-\text{ad}(X(q_1,p_1))} e^{\text{ad}(Y(q_1,p_1))}.$$

The first relation is a particular case of (4.5), while the second relation follows from the first one and

$$e^{-\text{ad}(Y)} \{f, g\} = \{e^{-\text{ad}(Y)} f, e^{-\text{ad}(Y)} g\},$$

which is another consequence of (4.5). Then the transformations (4.8) become

$$\begin{pmatrix} q_3^i \\ p_3^i \end{pmatrix} = e^{-\text{ad}(Y(q_1, p_1))} e^{-\text{ad}(X(q_1, p_1))} \begin{pmatrix} q_1^i \\ p_1^i \end{pmatrix}.$$

Since an equivalent version of (3.1) is $e^{-\text{ad}(Y)} e^{-\text{ad}(X)} = e^{-\text{ad}(X+Y+X\Delta Y)}$, the BCH formula (3.2) follows by comparison with (4.6) again.

Setting $\mathcal{C}(Y) = F_A$, $\mathcal{C}(X) = F_B$ and $F_C = \mathcal{C}(X) \circ \mathcal{C}(Y)$, we can easily check the first few orders of (3.2) by comparing the formulas (2.15) and (3.7).

Summarizing, the componential map is a sort of generating function for the exponential map. Indeed, the transformations of the coordinates and the momenta are given by the exponential map and generated by the componential map.

5 Diagrammatics of the componential map

We write the diagrammatic expansion of the componential map in the form

$$\mathcal{C}(X) = I + X + \sum_{n=2}^{\infty} \sum_{G_{nj} \in \mathcal{D}_n} e_{nj} G_{nj}(X), \quad (5.1)$$

where e_{nj} are certain coefficients, worked out below, and \mathcal{D}_n denotes the set of connected tree diagrams $G_{nj}(X)$ built with n vertices X and the propagator (2.6). Differently from the diagrams of the previous section, the propagator must carry an arrow, to distinguish where the q and the P derivatives act. For definiteness, we assume that the q derivative acts on the X toward which the arrow points and the P derivative acts on the X placed at the other endpoint of the line.

For example, the diagrams of formula (3.7) are

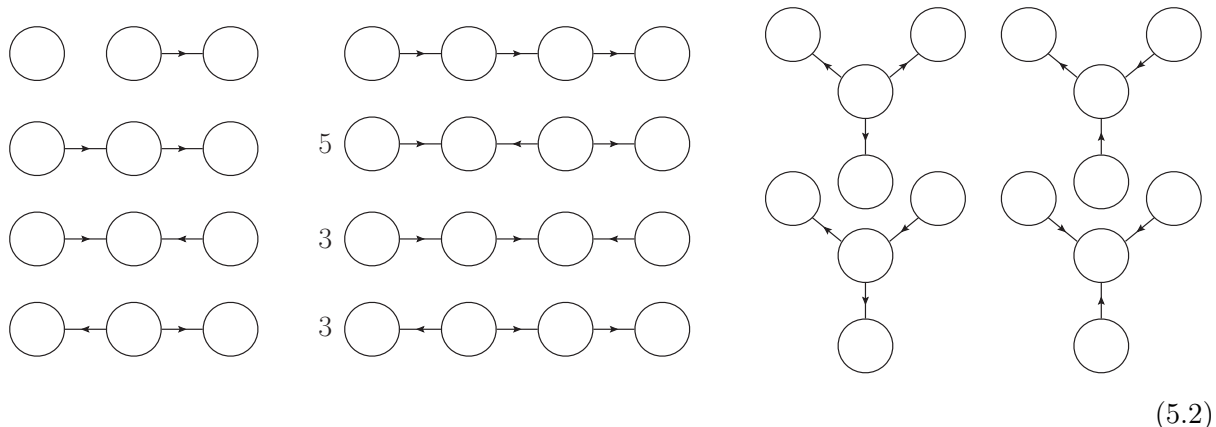

where we have included the coefficients $e_{nj}n!$ different from one. Each empty disk denotes an X .

We work out the rules to calculate the coefficients e_{nj} . It is evident that some of them are simple, others are less straightforward, such as the factor 5 appearing in the second line of formula

(3.7). It is convenient to refer to formula (3.5), which gives for $n > 1$,

$$c_n(X(q, P)) = \frac{1}{n} \sum_{m=1}^{n-1} \sum_{\substack{\{j_k\}, j_k \geq 1 \\ j_1 + \dots + j_m = n-1}} \sigma_{\{j_k\}} X_{i_1 \dots i_m}(q, P) \prod_{k=1}^m \frac{\partial c_{j_k}(X(q, P))}{\partial q^{i_k}}, \quad (5.3)$$

where the symmetry factor $\sigma_{\{j_k\}}$ is equal to one divided by the product of $\prod v_m!$, v_m being the number of times the integer m appears in the list $\{j_k\}$. We recall that $c_1(X(q, P)) = X(q, P)$.

The diagrammatic version of formula (5.3) is straightforward, because the coefficients are just the symmetry factors of the diagrams. Denote the function c_j by means of a disk numbered by j . Now the arrows can only exit X and enter c_j . For example, we have

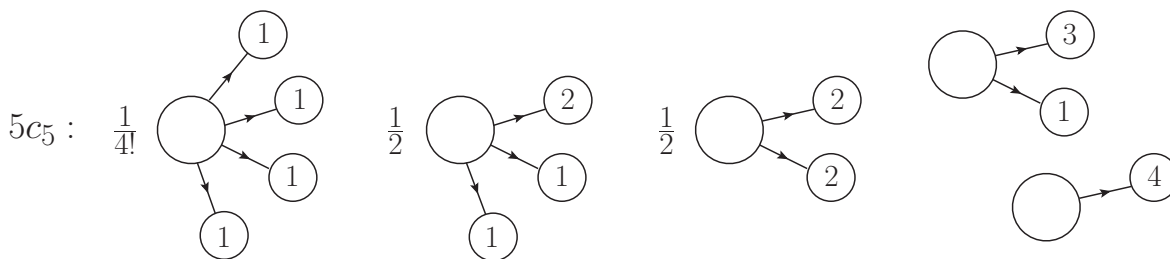

These diagrammatics generate the diagrammatics of (5.1) by iteration and allow us to find the rules to compute the coefficients e_{nj} . To formulate these rules, it is useful to define a suitable cutting procedure.

Given a diagram $G_{nj}(X)$, detect the disks to which only exiting lines are attached. Consider one of such disks at a time. Mark the disk with a symbol \times at its center and cut the lines attached to the disk in two. This operation gives a disconnected diagram. For example,

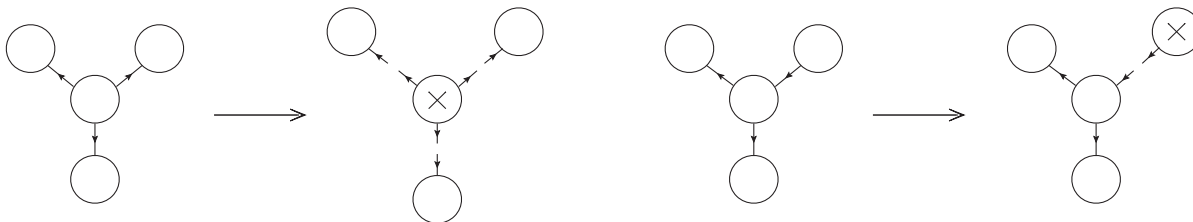

The so-obtained cut diagrams are made of two types of subdiagrams. One is the subdiagram made of the marked disk and its lines. The rest is a set of various subdiagrams $G'_{mi}(X)$, each of which is equal to a diagram of type $G_{mi}(X)$, $m < n$, with one extra incoming line.

To avoid overcounting, coinciding cut diagrams must be counted only once. For example, the cutting

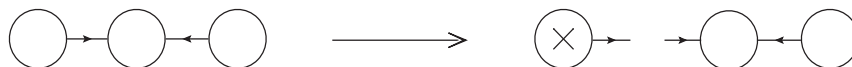

can be performed in two equivalent ways, by detaching the left disk or the right one. However, the results are the same, so we must count only one of them.

Denote the inequivalent cut diagrams by $G_{njk}^{\text{cut}}(X)$, where k is an extra label. Then the coefficient e_{nj} of G_{nj} is given by the formula

$$e_{nj} = \frac{1}{n} \sum_k e_{njk}, \quad (5.4)$$

where e_{njk} are coefficients of the cut diagrams G_{njk}^{cut} . To determine e_{njk} ,

- (i) divide by the number of permutations of the identical subdiagrams G'_{mi} , $m < n$;
- (ii) multiply by the number of ways to obtain each subdiagram G'_{mi} , $m < n$, by attaching the extra incoming line to G_{mi} ;
- (iii) multiply by the coefficients e_{mi} of the subdiagrams G_{mi} , $m < n$.

We illustrate these rules by means of a few examples. First, we see how to derive the coefficient 5 of formula (5.2), which corresponds to $e_{4j} = 5/24$. The diagram G_{4j} and its cuts are

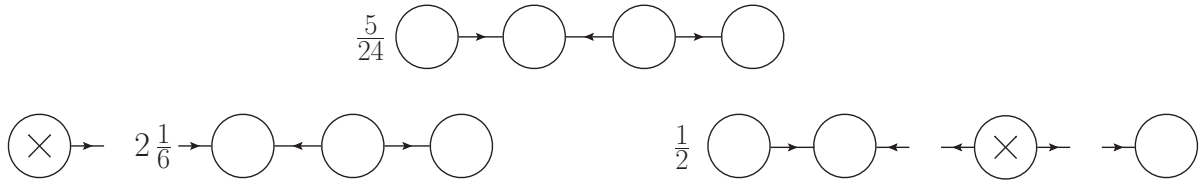

so we find

$$e_{4j} = \frac{1}{4} \left(2 \frac{1}{6} + \frac{1}{2} \right) = \frac{5}{24}.$$

The reason why the first cut diagram G'_{3i} has a factor 2, besides $e_{3i} = 1/6$, is that there are two ways of obtaining G'_{3i} by attaching the extra incoming line to G_{3i} . This is the meaning of rule (ii).

Next, consider the case

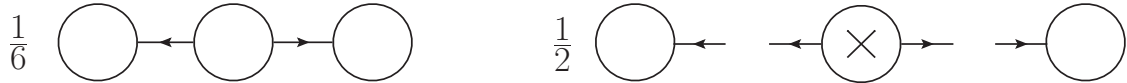

The factor $1/2$ in front of the cut diagram is due to the permutations of identical subdiagrams G'_{1i} . Thus, we have $e_{3i} = 1/3(1/2) = 1/6$. This is the meaning of rule (i).

Formula (5.4) and the rules just listed are straightforward consequences of (5.3). We have decomposed the diagram G_{nj} into its contributions as they appear on the right-hand side of (5.3), which are the cut diagrams G_{njk}^{cut} . Each of them has a simple combinatorial factor e_{njk} . The sum of those combinatorial factors, divided by n , gives e_{nj} .

An alternative, actually simpler, way to work out the diagrammatic expansion of the componential map is given in the next section. It follows from the expansion of the time-ordered componential map, which has straightforward coefficients. The coefficients of $\mathcal{C}(X)$ are the values of simple integrals that appear when the time-ordered formula is specialized to the case of a time-independent function X .

Finally, let us mention that we can define the componential logarithm of a canonical transformation, briefly called *c*-logarithm, by means of the inverse componential map. Writing $\mathcal{C} = I + c$ we can invert (3.7) recursively. The first orders of the *c*-logarithm are

$$X = c - \frac{1}{2}c_i c^i + \frac{1}{12} (c_{ij} c^i c^j + 4c^j c_j^i c_i + c^{ij} c_i c_j) - \frac{1}{12} \left(3c_i c_j^i c_k^j c^k + c_i c_j^i c^{jk} c_k + c^i c_{ij} c_k^j c^k + c^i c_{ij} c^{jk} c_k + c_i c_{jk}^i c^j c^k + c_i c_j c_k^{ij} c^k \right) + \dots$$

6 Time-ordered componential map

A canonical transformation continuously connected to the identity can be viewed as a fictitious “time” evolution associated with a suitable “Hamiltonian”. This allows us to relate the componential map to the solution of the Hamilton-Jacobi equation. In Sect. 4 we have taken advantage of this correspondence in the case of time-independent Hamiltonians, or, equivalently, η -independent functions $X(q, P)$. Generalizing the formulas of Sect. 4 to time-dependent Hamiltonians $H(q, p, t)$, we can obtain the time-ordered (precisely, η -ordered) componential map.

Start from a function $X(q, P, \eta)$ and consider the Hamilton-Jacobi equation

$$\frac{\partial}{\partial \eta} \mathcal{C}(q, P, \eta) = X \left(q^i, \frac{\partial}{\partial q^j} \mathcal{C}(q, P, \eta), \eta \right). \quad (6.1)$$

Writing $\mathcal{C}(q, P, \eta) = q^i P^i + c(q, P, \eta)$, we find

$$\begin{aligned} c(q, P, \eta) &= \int_0^\eta d\eta' X \left(q^i, P^j + \frac{\partial}{\partial q^j} c(q, P, \eta'), \eta' \right) \\ &= \int_0^\eta d\eta' X(q, P, \eta') + \sum_{n=1}^{\infty} \frac{1}{n!} \int_0^\eta d\eta' X_{i_1 \dots i_n}(q, P, \eta') \prod_{k=1}^n \frac{\partial c(q, P, \eta')}{\partial q^{i_k}}, \end{aligned}$$

which can be solved recursively with the help of the following diagrammatics.

Instead of considering the diagrams G_{nj} of the previous section, consider their η -ordered versions \tilde{G}_{nj} , determined by applying the following rules. Given a diagram G_{nj} , assign coordinates η_k to each disk. We say that

- the disk with coordinate η_k is anterior (posterior) to the disk with coordinate $\eta_{k'}$ if $\eta_k < \eta_{k'}$ ($\eta_k > \eta_{k'}$);
- a pair of disks is η -ordered if one of them is anterior to the other;

- two disks D_1 and D_2 are separated if the path connecting them (drawn by covering each line only once) contains a third disk D_3 that is posterior to both;
- the latest disk is the one with coordinate η_k such that $\eta_k > \eta_{k'}$ for every $k' \neq k$;
- given a disk D , the disk D' following D is the most anterior disk among the disks that are posterior to D and not separated from D .

Assume that the η coordinate is the horizontal one and it is oriented from the right to the left. Displace the disks of G_{nj} so that all the nonseparated pairs of disks become η -ordered and each arrow points from the posterior disk to the anterior one. Two diagrams are said to be equivalent if every pair of nonseparated disks has the same η ordering.

Then, construct all the inequivalent diagrams. Call them \tilde{G}_{nj} , where n is the number of disks and j is an extra label. Denote the set of diagrams with n disks by $\tilde{\mathcal{D}}_n$.

For example, the η -ordered versions of the diagrams of formula (5.2) are

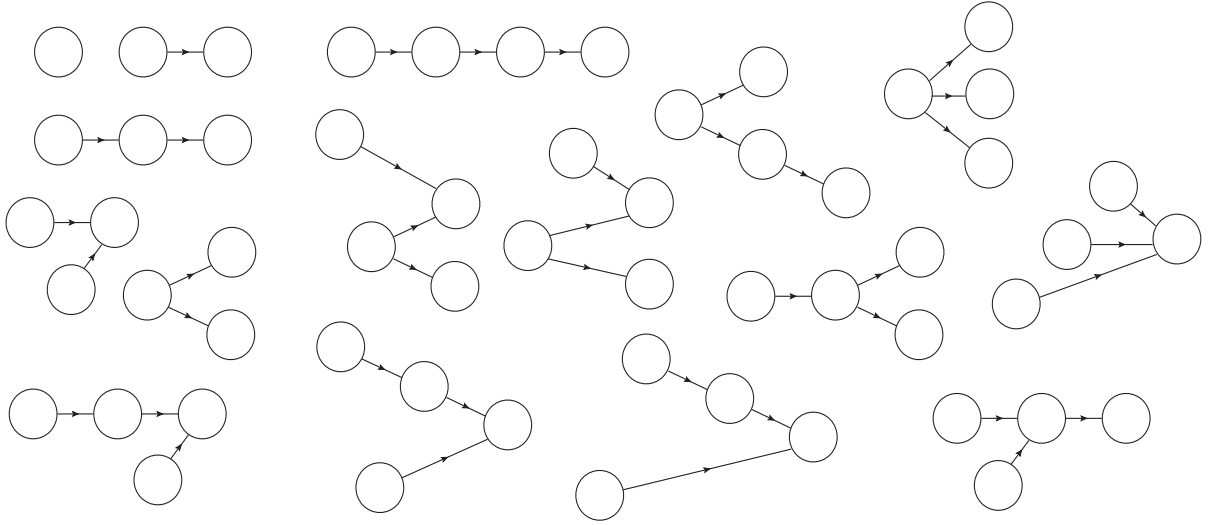

(6.2)

Given a diagram \tilde{G}_{nj} , associate a cut diagram $\tilde{G}_{nj}^{\text{cut}}$ with it by marking the latest disk with \times and detaching it from the rest as explained before. The operation generates subdiagrams \tilde{G}'_{mj} , each of which is built by adding an extra incoming line to a diagram of type \tilde{G}_{mj} , with $m < n$. The symmetry factor of \tilde{G}_{nj} is equal to the product of the symmetry factors of the subdiagrams \tilde{G}'_{mj} , divided by the number of permutations of the equivalent \tilde{G}'_{mj} s. The symmetry factor of a subdiagram \tilde{G}'_{mj} is equal to the number of ways to obtain it by adding the extra line to \tilde{G}_{mj} , times the symmetry factor of \tilde{G}_{mj} .

Finally, evaluate the diagram \tilde{G}_{nj} as follows. A disk with coordinate η_k corresponds to $X(q, P, \eta_k)$. As before, an oriented line is the propagator (2.6), the q derivative acting on the anterior disk and the P derivative acting on the posterior disk. Multiply by the symmetry factor of the diagram and integrate the coordinate η_k of each disk from 0 to the coordinate $\eta_{k'}$ of the following disk. Finally integrate the coordinate of the latest disk from 0 to η . This gives a function

$\tilde{G}_{nj}(q, P, \eta)$. The sum of these functions plus the identity map gives the η -ordered componential map, which reads

$$\mathcal{C}(q, P, \eta) = q^i P^i + \int_0^\eta d\eta' X(q, P, \eta') + \sum_{n=2}^{\infty} \sum_{\tilde{G}_{nj} \in \tilde{\mathcal{D}}_n} \tilde{G}_{nj}(q, P, \eta). \quad (6.3)$$

To order three we have

$$\begin{aligned} \mathcal{C}(q, P, \eta) &= q^i P^i + \int_0^\eta d\eta' X(q, P, \eta') + \int_0^\eta d\eta' X_i(q, P, \eta') \int_0^{\eta'} d\eta'' X^i(q, P, \eta'') \\ &\quad + \int_0^\eta d\eta' X_i(q, P, \eta') \int_0^{\eta'} d\eta'' X_j^i(q, P, \eta'') \int_0^{\eta''} d\eta''' X^j(q, P, \eta''') \\ &\quad + \int_0^\eta d\eta' X_i(q, P, \eta') \int_0^{\eta'} d\eta'' X_j(q, P, \eta'') \int_0^{\eta''} d\eta''' X^{ij}(q, P, \eta''') \\ &\quad + \frac{1}{2} \int_0^\eta d\eta' X_{ij}(q, P, \eta') \int_0^{\eta'} d\eta'' X^i(q, P, \eta'') \int_0^{\eta''} d\eta''' X^j(q, P, \eta''') + \dots \end{aligned} \quad (6.4)$$

As anticipated before, an alternative way to compute the coefficients e_{nj} and e_{njk} of formulas (5.1) and (5.4) is to use formula (6.3), assume that X is η independent, integrate the various coordinates η_k and finally set $\eta = 1$. Diagrams that are identical for the purposes of the previous section have different η orderings, which is why the coefficients of the η -ordered componential map are much simpler than e_{nj} and e_{njk} .

When we have a one-parameter family of generating functions $\mathcal{C}(q, P, \eta)$ such that $\mathcal{C}(q, P, 0) = I(q, P)$, we can give a more practical definition of logarithm. Viewing fictitiously the η dependence as a time evolution, we define the h-logarithm (h standing for ‘‘Hamiltonian’’) as the Hamiltonian $X(q, p, \eta)$ associated with it. By the Hamilton-Jacobi equation (6.1), we have

$$X(q, p, \eta) = \frac{\widetilde{\partial \mathcal{C}}}{\partial \eta}, \quad (6.5)$$

where the tilde means that the argument P must be solved in terms of q, p, η by means of the canonical transformation \mathcal{C} itself. For future use we remark that, in particular, if $f(q, p, \eta)$ is a function that behaves as a scalar under \mathcal{C} , i.e. such that $f'(Q, P, \eta) = f(q, p, \eta)$, we have

$$\frac{\partial f'}{\partial \eta} = \frac{\partial f}{\partial \eta} - \left\{ f, \frac{\widetilde{\partial \mathcal{C}}}{\partial \eta} \right\}. \quad (6.6)$$

If there is no parameter η to apply (6.5), the h-logarithm is not defined. If $\mathcal{C}(q, P, \eta, \zeta, \dots)$ depends on more parameters η, ζ, \dots and $\mathcal{C}(q, P, 0, 0, \dots)$ coincides with the identity map, we have one h-logarithm for each parameter. In the time-independent case $\mathcal{C}(\eta X(q, P))$, the h-logarithm $X(q, p, \eta)$ coincides with $X(q, p)$. Note that the c-logarithm always exists and is unique.

7 Canonical transformations and Batalin-Vilkovisky formalism

In this section we generalize the results found so far to the Batalin-Vilkovisky formalism, where the generating function(al)s are fermionic and the fields may be both bosonic and fermionic. Then we give some examples that have applications to both renormalizable and nonrenormalizable theories. We compose the canonical transformations that perform the gauge fixing with those that switch to the background field method. Then we use the componential map to interpolate between the background field approach and the standard nonbackground approach.

The Batalin-Vilkovisky formalism is convenient to study general gauge theories. The conjugate variables are the fields Φ^α and certain external sources K_α coupled to the Φ symmetry transformations. A notion of *antiparentheses*

$$(X, Y) \equiv \int \left(\frac{\delta_r X}{\delta \Phi^\alpha} \frac{\delta_l Y}{\delta K_\alpha} - \frac{\delta_r X}{\delta K_\alpha} \frac{\delta_l Y}{\delta \Phi^\alpha} \right) \quad (7.1)$$

is introduced, where X and Y are functionals of Φ and K , the integral is over spacetime points associated with repeated indices and the subscripts l and r in δ_l and δ_r denote the left and right functional derivatives, respectively. The fields Φ^α and the sources K_α have statistics ε_α and $\varepsilon_\alpha + 1$, respectively, which are equal to 0 mod 2 for bosons and 1 mod 2 for fermions.

The fields Φ^α include the classical fields ϕ^i , the Fadeev-Popov ghosts C^I , the antighosts \bar{C}^I and the Lagrange multipliers B^I for the gauge fixing. The action $S(\Phi, K)$ is a local functional that satisfies the master equation $(S, S) = 0$ and coincides with the classical action $S_c(\phi)$ at $C = \bar{C} = B = K = 0$.

The canonical transformations are the transformations $\Phi, K \rightarrow \Phi', K'$ that preserve the antiparentheses (7.1). They can be derived from a generating functional $F(\Phi, K')$ of fermionic statistics, by means of the formulas

$$\Phi^{\alpha'} = \frac{\delta F}{\delta K'_\alpha}, \quad K_\alpha = \frac{\delta F}{\delta \Phi^\alpha}.$$

The identity transformation is generated by $F(\Phi, K') = \int \Phi^\alpha K'_\alpha$.

The formulas derived in the previous sections for the componential map and the composition of canonical transformations can be immediately generalized to fermionic functionals of fields and sources of various statistics. Indeed, the basic operator, that is to say the propagator (2.6), is turned into

$$\int \frac{\overleftarrow{\delta}_r}{\delta \Phi^\alpha(x)} \frac{\overrightarrow{\delta}_l}{\delta K'_\alpha(x)}, \quad (7.2)$$

which has fermionic statistics. The functionals $F(\Phi, K')$, $\mathcal{C}(X)$ and X also have fermionic statistics. Thus, each time we add a propagator and a new disk X , the statistics are correctly preserved. As a consequence, the formulas found so far can be straightforwardly applied to the BV formalism.

Canonical transformations are used for various purposes in quantum field theory. They encode the most general (changes of) gauge fixing and changes of field variables. Moreover, they are an

important ingredient of the perturbative subtraction of divergences. Precisely, they subtract the divergences that are proportional to the field equations. The composition and the inversion of canonical transformations are operations that are met frequently. Often, it is enough to study them at the infinitesimal level, but sometimes it is necessary to handle them exactly or to all orders of the expansion. The literature on these topics is wide, both at the mathematical/formal level [1, 9] and at the level of renormalization and gauge dependence [10, 11, 12, 13, 14].

We recall that the BV formalism is quite versatile and can be used to formulate all kinds of general gauge theories, including those where the symmetry transformations close only on shell and those that have reducible gauge algebras (where the ghosts have local gauge symmetries of their own and it is necessary to introduce “ghosts of ghosts”). Our formulas hold in those cases also.

Nevertheless, we concentrate the applications of this section to the irreducible gauge symmetries that close off shell, which have the most important applications to physics. In those cases, there exists a solution $S(\Phi, K)$ of the master equation that is linear in K :

$$S(\Phi, K) = S_c(\phi) - \int R^\alpha(\Phi)K_\alpha. \quad (7.3)$$

The functions $R^\alpha(\Phi)$ are the symmetry transformations of the fields Φ^α . See for example the appendix of ref. [14] for explicit formulas in the case of general covariance, local Lorentz symmetry, Abelian gauge symmetries and non-Abelian Yang-Mills symmetries.

We give some examples of applications in the context of the background field method [15]. Two different approaches to formulate the background field method in the context of the BV formalism can be found in the literature, the one of refs. [12, 16] by Binosi and Quadri² and the one of the present author [18]. The two have properties that are good for different purposes. Here we follow the approach of [18]. One starts from the action

$$S(\Phi, K, \underline{\Phi}, \underline{K}) = S_c(\phi) - \int R^\alpha(\Phi)K_\alpha - \int R^\alpha(\underline{\Phi})\underline{K}_\alpha, \quad (7.4)$$

which is obtained from (7.3) by adding a background copy with vanishing classical action. It is not necessary to have background copies of the antighosts and the Lagrange multipliers, so we take $\underline{\Phi}^\alpha = \{\underline{\phi}^i, \underline{C}^I\}$ and $\underline{K}_\alpha = \{\underline{K}_\phi^i, \underline{K}_C^I\}$, where $\underline{\phi}^i$ and \underline{C}^I are background copies of the physical fields and the ghosts, respectively, and $\underline{K}_\phi^i, \underline{K}_C^I$ are the sources associated with them.

Then we perform the background shift, by means of the canonical transformation generated by³

$$F_b(\Phi, \underline{\Phi}, K', \underline{K}') = \int (\Phi^\alpha - \underline{\Phi}^\alpha)K'_\alpha + \int \underline{\Phi}^\alpha \underline{K}'_\alpha.$$

²See also [17] for a similar approach in the language of WTST identities and the Zinn-Justin equation.

³Differently from ref. [18], we understand that the fields and the sources with primes are the transformed ones. This originates some sign differences with respect to the formulas of [18].

Taking advantage of the componential map, we can write

$$F_b = \mathcal{C} \left(- \int \underline{\Phi}^\alpha K'_\alpha \right).$$

Indeed, the argument of \mathcal{C} does not depend on any pair of conjugate variables, so all the nontrivial diagrams of formula (5.1) vanish.

After the shift, the action is $F_b S$. The new fields Φ^α are called quantum fields. The symmetry transformations $R^i(\Phi)$ of ϕ^i are turned into the transformations $R^i(\Phi + \underline{\Phi})$ of $\phi^i + \underline{\phi}^i$. These can be decomposed as the sum of the background transformations $R^i(\underline{\Phi})$ of $\underline{\phi}^i$ plus the transformations $R^i(\Phi + \underline{\Phi}) - R^i(\underline{\Phi})$ of ϕ^i . In turn, the transformations of ϕ^i split into the sum of the quantum transformations of ϕ^i [made of the \underline{C} -independent part of $R^i(\Phi + \underline{\Phi}) - R^i(\underline{\Phi})$], plus the background transformations of ϕ^i (the \underline{C} -dependent part). Something similar happens to the symmetry transformations of the ghosts C .

The background transformations of the antighosts and the Lagrange multipliers remain trivial after F_b , and need to be adjusted by means of a further canonical transformation, generated by

$$F_{\text{nm}}(\Phi, \underline{\Phi}, K', \underline{K}') = \int \Phi^\alpha K'_\alpha + \int \underline{\Phi}^\alpha \underline{K}'_\alpha - \int \mathcal{R}_C^I(\bar{C}, \underline{C}) K'_B = \mathcal{C} \left(- \int \mathcal{R}_C^I(\bar{C}, \underline{C}) K'_B \right),$$

where $\mathcal{R}_C^I(\bar{C}, \underline{C})$ denotes the background transformation of the antighosts. Explicitly, the argument of the componential map \mathcal{C} is

$$\int (g f^{abc} \underline{C}^b \bar{C}^c + \underline{C}^\rho \partial_\rho \bar{C}^a) K'_B + \int (2 \underline{C}^{\hat{a}\hat{c}} \eta_{\hat{c}\hat{d}} \bar{C}^{\hat{d}\hat{b}} + \underline{C}^\rho \partial_\rho \bar{C}^{\hat{a}\hat{b}}) K'_{\hat{a}\hat{b}B} + \int (\underline{C}^\rho \partial_\rho \bar{C}_\mu - \bar{C}_\rho \partial_\mu \underline{C}^\rho) K_B^{\mu'}, \quad (7.5)$$

for Yang-Mills symmetries, local Lorentz symmetry and diffeomorphisms, where the hats on a, b, \dots are used to distinguish the local Lorentz indices from the Yang-Mills ones.

Finally, the theory can be gauge fixed in a background invariant way by means of the canonical transformation generated by

$$F_{\text{gf}}(\Phi, \underline{\Phi}, K', \underline{K}') = \int \Phi^\alpha K'_\alpha + \int \underline{\Phi}^\alpha \underline{K}'_\alpha - \Psi(\Phi, \underline{\phi}) = \mathcal{C}(-\Psi), \quad (7.6)$$

where $\Psi(\Phi, \underline{\phi})$ is a background invariant functional of fermionic statistics, known as gauge fermion. Typically, we choose it of the form

$$\Psi(\Phi, \underline{\phi}) = \int \bar{C}^I (G^{Ii}(\underline{\phi}, \partial) \phi^i + \zeta_{IJ}(\underline{\phi}, \partial) B^J),$$

where $G^{Ii}(\underline{\phi}, \partial) \phi^i$ are the gauge-fixing functions. It is common to choose such functions to be linear in the quantum fields ϕ^i , to simplify various properties of renormalization. The operator matrix $\zeta_{IJ}(\underline{\phi}, \partial)$ is symmetric, nonsingular at $\underline{\phi} = 0$ and proportional to the identity in every simple subgroup of the gauge symmetry group. The relation $F_{\text{gf}} = \mathcal{C}(-\Psi)$ of (7.6) follows from the fact that the gauge fermion does not depend on the sources K .

Invariance under background transformations is easy to achieve, by combining the plain derivative ∂ with the background field $\underline{\phi}$ to build the background covariant derivative. For example, we can take

$$\begin{aligned}\Psi &= \int \sqrt{|\underline{g}|} \bar{C}^a (\underline{g}^{\mu\nu} D_\mu(\underline{A}, \underline{g}) A_\nu^a + \zeta_1 B^a), \\ \Psi &= \int \sqrt{|\underline{g}|} \bar{C}_{\hat{a}\hat{b}} \left(\underline{e}^{\rho\hat{a}} \underline{g}^{\mu\nu} D_\mu(\underline{e}) D_\nu(\underline{e}) f_\rho^{\hat{b}} + \frac{\zeta_2}{2} B^{\hat{a}\hat{b}} + \frac{\zeta_3}{2} \underline{g}^{\mu\nu} D_\mu(\underline{e}) D_\nu(\underline{e}) B^{\hat{a}\hat{b}} \right), \\ \Psi &= \int \sqrt{|\underline{g}|} \bar{C}_\mu \left[\underline{g}^{\mu\nu} \underline{g}^{\rho\sigma} (D_\rho(\underline{g}) h_{\sigma\nu} + \zeta_4 D_\nu(\underline{g}) h_{\rho\sigma}) + \frac{\zeta_5}{2} \underline{g}^{\mu\nu} B_\nu \right],\end{aligned}$$

in the case of Yang-Mills symmetry (with a simple group, for simplicity), local Lorentz symmetry and diffeomorphisms, respectively, where ζ_i are constants, \underline{A}_μ^a , $\underline{e}_\mu^{\hat{a}}$ and $\underline{g}_{\mu\nu}$ are the background gauge field, vielbein and metric, A_μ^a , $f_\mu^{\hat{a}}$ and $h_{\mu\nu}$ are the respective quantum fluctuations and $D(\underline{A}, \underline{g})$, $D(\underline{g})$, $D(\underline{e})$ denote the covariant derivatives in the background fields.

The three canonical transformations F_b , F_{nm} and F_{gf} can be composed as follows. The first two commute and have a vanishing propagator, because the fields (sources) that appear nontrivially in F_{nm} have no source (field) counterpart in the nontrivial sector of F_b . Thus, the composition gives the generating functional

$$(F_b \circ F_{\text{nm}})(\Phi, \underline{\Phi}, K', \underline{K}') = \int (\Phi^\alpha - \underline{\Phi}^\alpha) K'_\alpha + \int \underline{\Phi}^\alpha \underline{K}'_\alpha - \int \mathcal{R}_{\bar{C}}^I(\bar{C}, \underline{C}) K_B^{I'}$$

and $F_b \circ F_{\text{nm}} = F_{\text{nm}} \circ F_b$.

Now we compose F_{nm} with F_{gf} . We can consider either $F_{\text{nm}} \circ F_{\text{gf}}$ or $F_{\text{gf}} \circ F_{\text{nm}}$. Applying formula (2.13), we see that in the first case there is no nontrivial diagram, since the nontrivial part of F_{gf} does not contain sources. Then formula (2.15) reduces to $C = A + B$ and we obtain

$$(F_{\text{nm}} \circ F_{\text{gf}})(\Phi, \underline{\Phi}, K', \underline{K}') = \int \Phi^\alpha K'_\alpha + \int \underline{\Phi}^\alpha \underline{K}'_\alpha - \int \mathcal{R}_{\bar{C}}^I(\bar{C}, \underline{C}) K_B^{I'} - \Psi(\Phi, \underline{\phi}).$$

Instead, when we consider $F_{\text{gf}} \circ F_{\text{nm}}$, we have one nontrivial diagram and formula (2.15) effectively reduces to $C = A + B + A_i B^i$. Note that the only nontrivial propagator is $(\overleftarrow{\delta} / \delta K_B^I)(\overrightarrow{\delta} / \delta B)$. The composed transformation is

$$(F_{\text{gf}} \circ F_{\text{nm}})(\Phi, \underline{\Phi}, K', \underline{K}') = (F_{\text{nm}} \circ F_{\text{gf}})(\Phi, \underline{\Phi}, K', \underline{K}') + \int \bar{C}^I \zeta_{IJ}(\underline{\phi}, \partial) \mathcal{R}_{\bar{C}}^J(\bar{C}, \underline{C}). \quad (7.7)$$

This result can also be found by applying the BCH formula (3.2) for the composition of the componential maps, with the Poisson brackets replaced by the antiparentheses (7.1). We find

$$(F_{\text{gf}} \circ F_{\text{nm}})(\Phi, \underline{\Phi}, K', \underline{K}') = \mathcal{C} \left(-\Psi(\Phi, \underline{\phi}) - \int \mathcal{R}_{\bar{C}}^I(\bar{C}, \underline{C}) K_B^{I'} + \frac{1}{2} \int \bar{C}^I \zeta_{IJ}(\underline{\phi}, \partial) \mathcal{R}_{\bar{C}}^J(\bar{C}, \underline{C}) \right).$$

It is easy to check that only the first two diagrams of (5.2) contribute, so formula (3.7) reduces to $\mathcal{C}(X) = I + X + (1/2)X_i X^i$, which gives (7.7).

In ref. [18] the tensor operator ζ_{IJ} was set to zero, to make F_{gf} and F_{nm} commute. However, in some applications, such as the chiral dimensional regularization of ref. [19], which is useful to treat nonrenormalizable general chiral gauge theories, it is necessary to keep ζ_{IJ} nonvanishing, to have well-behaved regularized propagators.

The gauge fixing is the last step of the construction of the action. Indeed, only after properly organizing the background transformations, it makes sense to talk about a background invariant gauge fermion. Thus, we must take $F_{\text{gf}} \circ F_{\text{nm}}$, rather than $F_{\text{nm}} \circ F_{\text{gf}}$.

The composition $F_{\text{gf}} \circ F_{\text{nm}} \circ F_{\text{b}}$ can be easily worked out by means of formula (2.16) and gives

$$\begin{aligned} F_{\text{gf}} \circ F_{\text{nm}} \circ F_{\text{b}} = & \int (\Phi^\alpha - \underline{\Phi}^\alpha) K'_\alpha + \int \underline{\Phi}^\alpha \underline{K}'_\alpha - \int \mathcal{R}_{\bar{C}}^I(\bar{C}, \underline{C}) K_B^{I'} \\ & - \Psi(\Phi - \underline{\Phi}, \underline{\phi}) + \int \bar{C}^I \zeta_{IJ}(\underline{\phi}, \partial) \mathcal{R}_{\bar{C}}^J(\bar{C}, \underline{C}). \end{aligned}$$

Applying the composed transformation to the action (7.4), we obtain the background field gauge-fixed action

$$S_{\text{b}} = (F_{\text{gf}} \circ F_{\text{nm}} \circ F_{\text{b}})S.$$

For various applications, it is useful to compare the results of the background field method with those of the standard, nonbackground approach. The nonbackground gauge fixed action is $\bar{S}_{\text{nb}} = F'_{\text{gf}}S$, where

$$F'_{\text{gf}}(\Phi, \underline{\Phi}, K', \underline{K}') = \int \Phi^\alpha K'_\alpha + \int \underline{\Phi}^\alpha \underline{K}'_\alpha - \Psi'(\Phi) = \mathcal{C}(-\Psi'(\Phi))$$

is the generating functional of the canonical transformation that performs the gauge fixing. The background fields and sources are inert here. As usual, to simplify the renormalization, it is convenient to take a quadratic gauge fermion Ψ' . We choose

$$\Psi'(\Phi) = \int \bar{C}^I (G^{Ii}(0, \partial)\phi^i + \zeta_{IJ}(0, \partial)B^J).$$

For convenience, we further make an irrelevant background shift by applying F_{b} , that is to say redefine the nonbackground action as $S_{\text{nb}} = (F_{\text{b}} \circ F'_{\text{gf}})S$. Then the relation between the background and nonbackground actions reads

$$S_{\text{b}} = (F_{\text{gf}} \circ F_{\text{nm}} \circ F_{\text{b}} \circ F'_{\text{gf}}{}^{-1} \circ F_{\text{b}}{}^{-1})S_{\text{nb}}.$$

Formulas (2.16) and (2.17) give

$$F_{\text{b}} \circ F'_{\text{gf}}{}^{-1} \circ F_{\text{b}}{}^{-1} = \int \Phi^\alpha K'_\alpha + \int \underline{\Phi}^\alpha \underline{K}'_\alpha + \Psi'(\Phi + \underline{\Phi}).$$

Using (7.7) and (2.16) again, we easily find

$$\begin{aligned} F_{\text{gf}} \circ F_{\text{nm}} \circ F_{\text{b}} \circ F'_{\text{gf}}{}^{-1} \circ F_{\text{b}}{}^{-1} = & \int \Phi^\alpha K'_\alpha + \int \underline{\Phi}^\alpha \underline{K}'_\alpha - \Delta\Psi(\Phi, \underline{\Phi}) - \int \mathcal{R}_{\bar{C}}^I(\bar{C}, \underline{C}) K_B^{I'} \\ & + \int \bar{C}^I \zeta_{IJ}(\underline{\phi}, \partial) \mathcal{R}_{\bar{C}}^J(\bar{C}, \underline{C}), \end{aligned}$$

where

$$\Delta\Psi(\Phi, \underline{\Phi}) = \int \bar{C}^I (G^{Ii}(\underline{\phi}, \partial)\phi^i - G^{Ii}(0, \partial)(\phi^i + \underline{\phi}^i) + (\zeta_{IJ}(\underline{\phi}, \partial) - \zeta_{IJ}(0, \partial))B^J) \quad (7.8)$$

is the difference between the background field gauge fermion and the nonbackground one.

Using the componential map, we find

$$F_{\text{gf}} \circ F_{\text{nm}} \circ F_{\text{b}} \circ F_{\text{gf}}^{-1} \circ F_{\text{b}}^{-1} = \mathcal{C}(X),$$

where

$$X = -\Delta\Psi(\Phi, \underline{\Phi}) - \int \mathcal{R}_{\bar{C}}^I(\bar{C}, \underline{C})K_B^{I'} + \frac{1}{2} \int \bar{C}^I (\zeta_{IJ}(\underline{\phi}, \partial) + \zeta_{IJ}(0, \partial)) \mathcal{R}_{\bar{C}}^J(\bar{C}, \underline{C}).$$

Again, formula (3.7) reduces to $\mathcal{C}(X) = I + X + (1/2)X_i X^i$, because the only nontrivial propagator is $(\overleftarrow{\delta}/\delta K_B^{I'}) (\overrightarrow{\delta}/\delta B)$ and X is linear in $B, K_B^{I'}$.

We can continuously interpolate between the background and nonbackground approaches by introducing a parameter ξ that varies from 0 to 1 and considering the canonical transformation generated by

$$F_\xi = \mathcal{C}(\xi X). \quad (7.9)$$

Explicitly, we find

$$\begin{aligned} F_\xi(\Phi, \underline{\Phi}, K', \underline{K}', \xi) &= \int \Phi^\alpha K'_\alpha + \int \underline{\Phi}^\alpha \underline{K}'_\alpha - \xi \Delta\Psi - \xi \int \mathcal{R}_{\bar{C}}^I(\bar{C}, \underline{C})K_B^{I'} \\ &\quad + \frac{\xi}{2} \int \bar{C}^I [(1 + \xi)\zeta_{IJ}(\underline{\phi}, \partial) + (1 - \xi)\zeta_{IJ}(0, \partial)] \mathcal{R}_{\bar{C}}^J(\bar{C}, \underline{C}). \end{aligned} \quad (7.10)$$

Note that the h-logarithm of (7.9) is equal to X with $K_B^{I'}$ replaced by K_B^I and plays the role of the ξ -independent Hamiltonian.

A different interpolation amounts to taking, for example,

$$F'_\xi = \int \Phi^\alpha K'_\alpha + \int \underline{\Phi}^\alpha \underline{K}'_\alpha - \xi \Delta\Psi(\Phi, \underline{\Phi}) - \xi \int \mathcal{R}_{\bar{C}}^I(\bar{C}, \underline{C})K_B^{I'} + \xi \int \bar{C}^I \zeta_{IJ}(\underline{\phi}, \partial) \mathcal{R}_{\bar{C}}^J(\bar{C}, \underline{C}). \quad (7.11)$$

The h-logarithm of this expression gives a ξ -dependent Hamiltonian, which we now calculate.

Assume that $U(\Phi, K, \xi)$ is a function that behaves as a scalar under canonical transformations $\Phi, K \rightarrow \Phi', K'$, i.e. such that $U'(\Phi', K', \xi) = U(\Phi, K, \xi)$. Then formula (6.6) turns into [11] (see also the appendix of [18])

$$\frac{\partial U'}{\partial \xi} = \frac{\partial U}{\partial \xi} - (U, Y), \quad Y(\Phi, K, \xi) = \widetilde{\frac{\partial \mathcal{F}}{\partial \xi}}, \quad (7.12)$$

where $\mathcal{F}(\Phi, K', \xi)$ is the generating functional of the canonical transformation and the tilde means that, after taking the ξ derivative, the source K' must be expressed in terms of Φ, K and ξ .

Choosing $\mathcal{F} = F'_\xi$ and enlarging the sets of fields and sources to include the background ones, we find the h-logarithm

$$Y(\Phi, K, \underline{\Phi}, \underline{K}, \xi) = -\Delta\Psi(\Phi, \underline{\Phi}) - \int \mathcal{R}_C^I(\bar{C}, \underline{C}) K_B^I + \int \bar{C}^J [(1 - \xi)\zeta_{JI}(\phi, \partial) + \xi\zeta_{JI}(0, \partial)] \mathcal{R}_C^I(\bar{C}, \underline{C}).$$

It may be more convenient to work with the interpolation (7.10), whose h-logarithm is ξ independent, rather than (7.11).

The dependence of the correlation functions on the parameters introduced by a canonical transformation is encoded into the equations of gauge dependence [20, 10, 11, 21, 13], sometimes known as Nielsen identities. The componential map and the other tools of this paper may be convenient to manipulate those equations more efficiently. In particular, the interpolation (7.9) allows us to take advantage of the background field method and prove key properties of renormalization in simpler, more powerful ways. An illustration of this fact can be found in ref. [22], where an important theorem about the cohomology of renormalization was proved. That theorem allows us to classify the structures of the counterterms and the local contributions to anomalies.

In turn, the classification of counterterms and anomalies is important to show, to all orders of the perturbative expansion, that the gauge symmetries are not affected by the subtraction of divergences (up to canonical transformations). The background field method and the interpolation (7.11) have been used [18] to achieve this goal in manifestly nonanomalous theories, renormalizable or not. In potentially anomalous nonrenormalizable theories, such as the standard model coupled to quantum gravity, which require a more involved regularization [19], the goal must be achieved together with the proof of the Adler-Bardeen theorem [23, 24] for the cancelation of anomalies to all orders (when they vanish at one loop). Within the standard, nonbackground approach, this was done for the first time in ref. [24]. The techniques of this paper and the results of [22] may be useful to upgrade the derivation of [24] to the background field approach and prepare the ground to make further progress.

8 Conclusions

Canonical transformations play an important role not only in classical mechanics, but also in quantum field theory. In several situations, it is useful to have practical formulas for the perturbative expansion of the generating functions around the identity map. In this paper we have given a number of such formulas, starting from the composition law, which we have expressed as the tree sector of a functional integral and later rephrased by means of the componential map.

The componential map is a standard way to express the generating function of a canonical transformation. It makes the inverse operation straightforward and obeys the Baker-Campbell-Hausdorff formula. It also admits a simple diagrammatic interpretation and a time-ordered generalization. It can be related to the solution of the Hamilton-Jacobi equation, expressed as a

perturbative expansion in powers of a suitable Hamiltonian, its derivatives and its integrals over time.

The formulas we have found can be straightforwardly generalized from classical mechanics to quantum field theory, where the functionals and the conjugate variables may have both bosonic and fermionic statistics. Particularly interesting are the applications to the Batalin-Vilkovisky formalism. Canonical transformations are commonly used to implement the gauge fixing, make arbitrary changes of field variables and changes of the gauge fixing itself, switch to the background field method and subtract the counterterms proportional to the field equations. Various times these operations must be composed and inverted. Practical formulas, such as the ones given in this paper, allow us to handle these operations quickly. In particular, they can be convenient in nonrenormalizable theories, where the cohomology of counterterms and anomalies involves non-polynomial functionals and the renormalization of divergences involves nonpolynomial canonical transformations.

References

- [1] I.A. Batalin and G.A. Vilkovisky, Gauge algebra and quantization, Phys. Lett. B 102 (1981) 27-31;
I.A. Batalin and G.A. Vilkovisky, Quantization of gauge theories with linearly dependent generators, Phys. Rev. D 28 (1983) 2567, Erratum-ibid. D 30 (1984) 508.
- [2] See also S. Weinberg, *The quantum theory of fields*, vol. II, Cambridge University Press, Cambridge 1995.
- [3] J.C. Ward, An identity in quantum electrodynamics, Phys. Rev. 78, (1950) 182;
Y. Takahashi, On the generalized Ward identity, Nuovo Cimento, 6 (1957) 371;
A.A. Slavnov, Ward identities in gauge theories, Theor. Math. Phys. 10 (1972) 99;
J.C. Taylor, Ward identities and charge renormalization of Yang-Mills field, Nucl. Phys. B33 (1971) 436.
- [4] J. Campbell, On a law of combination of operators bearing on the theory of continuous transformation groups, Proc. Lond. Math. Soc. 28 (1897) 381;
J. Campbell, On a law of combination of operators (second paper), Proc. Lond. Math. Soc. 29 (1898) 14;
H. Poincaré, Sur les groupes continus, Comptes Rendus Acad. Sci. Paris 128 (1899) 1065;
H. Baker, Alternants and continuous groups, Proc. Lond. Math. Soc. 3 (1905) 24;

- F. Hausdorff, Die symbolische Exponentialformel in der Gruppentheorie, Berichte über die Verhandlungen Sächsischen Akademie der Wissenschaften zu Leipzig 58 (1906) 19;
- E.B. Dynkin, Calculation of the coefficients in the Campbell–Hausdorff formula, Doklady Akademii Nauk SSSR (in Russian) 57 (1947) 323.
- [5] V. Guillemin and S. Sternberg, *Semi-classical analysis*, International Press of Boston, Inc., Somerville, MA, Usa, 2013.
- [6] Y. Uwano, N. Chekanov, V. Rostovtsev and S. Vinitzky, On normalization of a class of polynomial Hamiltonians: from ordinary and inverse points of view, in *Computer algebra in scientific computing — CASC’99* (Munich), 1999.
- [7] E.D. Davis and G.I. Ghandour, Canonical transformations and non-unitary evolution, J. Phys. A: Math. Gen. 35 (2002) 5875 and arXiv:quant-ph/9905002.
- [8] A.S. Cattaneo, B. Dherin and G. Felder, Formal symplectic groupoid, Comm. Math. Phys. 253 (2005) 645 and arXiv:math/0312380 [math.SG].
- [9] For recent developments, see I.A. Batalin, K. Bering and P.H. Damgaard, On generalized gauge-fixing in the field-antifield formalism, Nucl.Phys. B739 (2006) 389 and arXiv:hep-th/0512131;
- I.A. Batalin, P.M. Lavrov and I.V. Tyutin, Finite anticanonical transformations in field-antifield formalism, Eur. Phys. J. C75 (2015) 6, 270 and arXiv:1501.07334 [hep-th].
- [10] B.L. Voronov, P.M. Lavrov and I.V. Tyutin, Canonical transformations and the gauge dependence in general gauge theories, Yad. Fiz. 36 (1982) 498 [Sov. J. Nucl. Phys. 36 (1982) 292].
- [11] D. Anselmi, Removal of divergences with the Batalin-Vilkovisky formalism, Class. and Quantum Grav. 11 (1994) 2181, 93A2 Renormalization.com and arXiv:hep-th/9309085;
- D. Anselmi, More on the subtraction algorithm, Class. and Quantum Grav. 12 (1995) 319, 94A1 Renormalization.com and arXiv:hep-th/9407023.
- [12] D. Binosi and A. Quadri, Canonical transformations and renormalization group invariance in the presence of nontrivial backgrounds, Phys. Rev. D85 (2012) 085020 and arXiv:1201.1807 [hep-th];
- D. Binosi and A. Quadri, The background field method as a canonical transformation, Phys.Rev. D85 (2012) 121702 and arXiv:1203.6637 [hep-th].

- [13] G. Barnich and P.A. Grassi, Gauge dependence of effective action and renormalization group functions in effective gauge theories, Phys. Rev. D62 (2000) 105010 and arXiv:hep-th/0004138;
- G. Barnich, Classical and quantum aspects of the extended antifield formalism, Proceedings of the Spring School “QFT and Hamiltonian Systems”, Calimanesti, Romania, May 2000, and arXiv:hep-th/0011120;
- I.A. Batalin and K. Bering, Gauge independence in a higher-order Lagrangian formalism via change of variables in the path integral, Phys.Lett. B742 (2015) 23 and arXiv:1408.5121 [hep-th];
- A. Quadri, Canonical flow in the space of gauge parameters, Theor. Math. Phys. 182 (2015) 74 [Teor. Mat. Fiz. 182 (2014) 91] and arXiv:1412.6772.
- [14] D. Anselmi, Ward identities and gauge independence in general chiral gauge theories, Phys. Rev. D 92 (2015) 025027, 15A1 Renormalization.com and arXiv:1501.06692 [hep-th].
- [15] B.S. De Witt, Quantum theory of gravity. II. The manifestly covariant theory, Phys. Rev. 162 (1967) 1195;
- B.S. De Witt, *Dynamic theory of groups and fields*, Gordon and breach, New York, 1965;
- L.F. Abbott, The background field method beyond one loop, Nucl. Phys. B 185 (1981) 189.
- [16] D. Binosi and A. Quadri, Slavnov-Taylor constraints for nontrivial backgrounds, Phys. Rev. D84 (2011) 065017 and arXiv:1106.3240 [hep-th].
- [17] P.A. Grassi, Stability and renormalization of Yang-Mills theory with background field method: a regularization independent proof, Nucl. Phys. B 462 (1996) 524 and arXiv:hep-th/9505101;
- P.A. Grassi, Renormalization of nonsemisimple gauge models with the background field method, Nucl. Phys. B 560 (1999) 499 and arXiv:hep-th/9908188.
- [18] D. Anselmi, Background field method, Batalin-Vilkovisky formalism and parametric completeness of renormalization, Phys. Rev. D 89 (2014) 045004, 13A3 Renormalization.com and arXiv:1311.2704 [hep-th].
- [19] D. Anselmi, Weighted power counting and chiral dimensional regularization, Phys. Rev. D 89 (2014) 125024, 14A2 Renormalization.com and arXiv:1405.3110 [hep-th].
- [20] W.E. Caswell and F. Wilczek, On the gauge dependence of renormalization group parameters, Phys. Lett. B49 (1974) 291;

- N. K. Nielsen, On the gauge dependence of spontaneous symmetry breaking in gauge theories, Nucl. Phys. B 101 (1975) 173;
- O. Piguet and K. Sibold, Gauge independence in ordinary Yang-Mills theories, Nucl. Phys. B253 (1985) 517.
- [21] R. Haeussling, E. Kraus and K. Sibold, Gauge parameter dependence in the background field gauge and the construction of an invariant charge, Nucl.Phys. B539 (1999) 691 and arXiv:hep-th/9807088.
- [22] D. Anselmi, Background field method and the cohomology of renormalization, 15A4 Renormalization.com and arXiv:1511.01244 [hep-th].
- [23] S.L. Adler and W.A. Bardeen, Absence of higher order corrections in the anomalous axial vector divergence, Phys. Rev. 182 (1969) 1517;
- A. Zee, Axial-vector anomalies and the scaling property of field theory, Phys. Rev. Letters 29 (1972) 1198;
- J. Collins, *Renormalization*, Cambridge University Press, 1984, Chapter 13;
- T. Marinucci and M. Tonin, Dimensional regularization and anomalies, Il Nuovo Cimento A 31 (1976) 381;
- G. Costa, J. Julve, T. Marinucci and M. Tonin, Non-Abelian gauge theories and triangle anomalies, Nuovo Cimento A 38 (1977) 373;
- C. Lucchesi, O. Piguet and K. Sibold, The Adler-Bardeen theorem for the axial U(1) anomaly in a general non-Abelian gauge theory, Int. J. Mod. Phys. A 2 (1987) 385;
- O. Piguet and S. Sorella, Adler-Bardeen theorem and vanishing of the gauge beta function, Nucl.Phys. B 395 (1993) 661 and arXiv:hep-th/9302123;
- E. Witten, Global aspects of current algebra, Nucl. Phys. B 223 (1983) 422;
- E. Kraus, Anomalies in quantum field theory: properties and characterization, Talk presented at the Hesselberg workshop “Renormalization and regularization”, 2002, arXiv:hep-th/0211084;
- D. Anselmi, Adler-Bardeen theorem and manifest anomaly cancellation to all orders in gauge theories, Eur. Phys. J. C74 (2014) 3083, 14A1 Renormalization.com and arXiv:1402.6453 [hep-th];
- For a review till 2004, see S.L. Adler, Anomalies to all orders, in “*Fifty Years of Yang-Mills Theory*”, G. 't Hooft ed., World Scientific, Singapore, 2005, p. 187-228, and arXiv:hep-th/0405040.

- [24] D. Anselmi, Adler-Bardeen theorem and cancellation of gauge anomalies to all orders in nonrenormalizable theories, Phys. Rev. D 91 (2015) 105016, 15A2 Renormalization.com and arXiv:1501.07014 [hep-th].