

4d $\mathcal{N} = 2$ SCFT and singularity theory Part I: Classification

Dan Xie^{b,c} Shing-Tung Yau^{a,b,c}

^a*Department of Mathematics, Harvard University, Cambridge, MA 02138, USA*

^b*Center of Mathematical Sciences and Applications, Harvard University, Cambridge, 02138, USA*

^c*Jefferson Physical Laboratory, Harvard University, Cambridge, MA 02138, USA*

ABSTRACT: This is the first of a series of papers in which we systematically use singularity theory to study four dimensional $\mathcal{N} = 2$ superconformal field theories. Our main focus in this paper is to identify what kind of singularity is needed to define a SCFT. The constraint for a hypersurface singularity has been found by Sharpere and Vafa, and here the complete set of solutions are listed using a related mathematical result of Stephen S. T. Yau and Yu. We also study other type of singularities such as the complete intersection, quotient of hypersurface singularity by a finite group and non-isolated singularity. We finally conjecture that any three dimensional rational Gorenstein graded isolated singularity should define a $\mathcal{N} = 2$ SCFT. We explain how to extract various interesting physical quantities such as Seiberg-Witten geometry, central charges, exact marginal deformations, BPS quiver, RG flow trajectory, etc from the properties of singularity.

Contents

1	Introduction	2
2	Isolated hypersurface singularity and $\mathcal{N} = 2$ SCFT	4
2.1	Constraint on hypersurface singularity	5
2.2	Mini-versal deformation and Seiberg-Witten solution	6
2.3	Discriminant locus, bifurcation diagram and extra massless particles	9
2.4	Period integral and low energy effective action	11
2.5	Monodromy, vanishing cycles and BPS quiver	12
2.6	Central charge a and c	16
2.7	Exact marginal deformations, duality group and moduli of singularity	18
2.8	RG webs and adjacency of singularity	19
2.9	Summary	20
3	Classification of hypersurface singularity	22
3.1	Type I	24
3.2	Type II	26
3.3	Type III	27
3.4	Type IV	28
3.5	Type V	29
3.6	Type VI	30
3.7	Type VII	30
3.8	Type VIII	31
3.9	Type IX	32
3.10	Type X	33
3.11	Type XI	34
3.12	Type XII	35
3.13	Type XIII	36
3.14	Type XIV	37
3.15	Type XV	37
3.16	Type XVI	38
3.17	Type XVII	39
3.18	Type XVIII	39
3.19	Type XIX	39
4	Beyond hypersurface singularity	40
4.1	Complete intersection	41
4.2	Quotient by finite group	43
4.3	General isolated singularity	45
4.4	Non-isolated singularity and class \mathcal{S} theory	46

1 Introduction

The space of four dimensional $\mathcal{N} = 2$ superconformal field theory (SCFT) is becoming increasingly larger since the Seiberg-Witten (SW) solution was found [1, 2]. The two earlier examples studied in [2] are SU(2) gauge theory coupled with 4 fundamental flavors and SU(2) gauge theory coupled with an adjoint hypermultiplet. It became immediately clear that one can find many new SCFTs with Lagrangian descriptions [3, 4], and it was also soon realized that more exotic SCFTs like Argyres-Douglas theories [5–7] exist. Quite recently, the space of $\mathcal{N} = 2$ SCFT is greatly enlarged by the so-called class \mathcal{S} construction in which one can engineer 4d $\mathcal{N} = 2$ theory by putting 6d (2, 0) theory on a punctured Riemann surface [8–12]. Usually some of SCFTs in this class can be described by non-abelian gauge groups coupled to various matter contents, such as free hypermultiplets, strongly coupled matter systems like T_N theory and its cousins.

Given such rich set of theories found already, one might wonder if we can further enlarge the space of $\mathcal{N} = 2$ SCFTs. One feature of above class is that SW solution of almost all the theories considered above is given by a curve fibered over the Coulomb branch moduli space, namely, the SW curve is put in the form $F(x, z, \lambda_i) = 0$ where λ_i are the parameter spaces of Coulomb branch including couplings, masses, and Coulomb branch moduli. However, as pioneered and emphasized by Vafa and collaborators in a series of papers [13–16] back in 90s, the SW solution of general $\mathcal{N} = 2$ theory should be given by a three fold fibered over the moduli space: $F(z_0, z_1, z_2, z_3, \lambda_i) = 0$, and only in special case the solution can be reduced to a curve fibration. For example, the solution of quiver gauge theory with affine E shape might only take a form of three fold fibration [14]. Recently, this approach has been used in [11, 17–20] to find many new interesting theories.

One could greatly extend the space of $\mathcal{N} = 2$ SCFTs by looking at all possible theories whose SW solution is given by three-fold fibration. Now following the philosophy of geometric engineering [16, 21], one only need to start with a three-fold singularity, and the full SW solution is given by the deformation of the singularity [16]. So the classification of $\mathcal{N} = 2$ theory is reduced to the classification of possible singularities, and this significantly simplifies the task of classification.

The main purpose of this paper is to try to use algebraic geometry of singularity theory to systematically classify possible $\mathcal{N} = 2$ theory following the ideas in [16]. The constraints on isolated three-fold hypersurface singularities (IHS) defined by a polynomial $f(z_0, z_1, z_2, z_3)$ are already described in [15, 16]: a key feature for $\mathcal{N} = 2$ SCFT is the existence of a $U(1)_R$ symmetry and geometrically this implies that the three-fold singularity should have a \mathbb{C}^* action:

$$f(\lambda^{q_i} z_i) = \lambda f(z_i), \quad q_i > 0; \tag{1.1}$$

Moreover to get a sensible SCFT, the weights of \mathbb{C}^* action have to satisfy the following condition:

$$\sum q_i > 1. \quad (1.2)$$

Shapere and Vafa conjectured that that these are the necessary and sufficient conditions for IHS to define a $\mathcal{N} = 2$ SCFT [16]. Therefore the classification of SCFTs arising from IHS is reduced to the classification of IHS with \mathbb{C}^* action whose weights satisfy 1.2. Interestingly, such singularities have already been classified by Stephen S.T. Yau and Yu in a rather different mathematical context [22], and we simply reorganize their results here.

One of the most remarkable advantage of using singularity to define a SCFT is that the SW solution is automatically given by the mini-versal deformation of the singularity [23]. Let's take $\phi_\alpha(z)$ as the monomial basis of the Jacobi algebra $\mathbb{C}[z_0, z_1, z_2, z_3]/(\frac{\partial f}{\partial z_0}, \frac{\partial f}{\partial z_1}, \frac{\partial f}{\partial z_2}, \frac{\partial f}{\partial z_3})$, then the SW geometry is simply given by the following formula [16]:

$$F(z, \lambda) = f(z) + \sum_{i=1}^{\mu} \lambda_\alpha \phi_\alpha(z),$$

$$\Omega = \frac{dz_0 \wedge dz_1 \wedge dz_2 \wedge dz_3}{dF}; \quad (1.3)$$

Here μ is the dimension of Jacobi algebra, and Ω is the SW differential. The scaling dimensions of λ_α can also be easily computed by requiring Ω having dimension one as it gives the mass of BPS particles. Once the SW solution is given, we can study various physical quantities such as low energy effective action, central charges, BPS spectrum, RG flow, etc. It turns out that those properties are naturally related to the quantity studied in the singularity theory [23–26].

One can also consider other type of three-fold singularities¹ to engineer $\mathcal{N} = 2$ SCFTs:

- One can use an isolated complete intersection singularity (ICIS) defined by the map $f : (\mathbb{C}^{n+3}, 0) \rightarrow (\mathbb{C}^n, 0)$. Assume the singularity is defined by the equations $f_1 = f_2 = \dots = f_n = 0$, we require that these polynomials are quasi-homogeneous so that the weights of the coordinates z_i are $w_i, i = 1, \dots, n + 3$, and the degrees of f_i are $d_i, i = 1, \dots, n$. The condition for the existence of a SCFT is

$$\sum w_i - \sum d_i > 0; \quad (1.4)$$

- If the ICIS has certain discrete symmetry group G which preserves the canonical three form, we can form a quotient singularity using group G . This will produce a large number of new SCFTs.
- We can also consider non-isolated singularity, and it appears that theory of class \mathcal{S} falls in this category.
- In general, we expect that a **rational graded Gorenstein** isolated three-fold singularity would give us a four dimensional $\mathcal{N} = 2$ SCFT. Here graded means that the

¹The isolated singularity can always be described by an affine variety [27].

singularity should have a \mathbb{C}^* action, and Gorenstein means that there is a canonical well defined $(3, 0)$ form on the singularity [27], finally rational means that the weights of the $(3, 0)$ form under the \mathbb{C}^* action is positive.

For these constructions, we will discuss some basic ingredients and give some illustrative examples. We leave a complete classification to the future study.

We should emphasize that the major perspective of this paper is to explore the relation between geometric singularity theory and $\mathcal{N} = 2$ theory. More generally, one could use any 2d $(2, 2)$ SCFT with $\hat{c} < 2$ ² to construct a 4d $\mathcal{N} = 2$ theories [16, 20]³, and it would be definitely interesting to further explore along this approach.

This paper is organized as follows: section two reviews the constraints on hypersurface singularity so we can find a SCFT, and we further discuss various physical properties which can be extracted from geometry; Section three gives a complete classification for the hypersurface singularity which would define a SCFT; Section four discusses how to use other type of singularities to define new SCFTs; Finally a short conclusion is given in section five.

2 Isolated hypersurface singularity and $\mathcal{N} = 2$ SCFT

The dynamics of four dimensional $\mathcal{N} = 2$ theory is very rich, see [28] for a detailed review and here we summarize some useful facts for later use. We are interested in $\mathcal{N} = 2$ SCFT so the theory has an $SU(2)_R \times U(1)_R$ R symmetry, and the theory might also have some flavor symmetries G .

$\mathcal{N} = 2$ theory has an interesting moduli space of vacua which could be separated into Coulomb branch, Higgs branch, and mixed branches which is a direct product of a Coulomb component and a Higgs component. The IR theory on the Higgs branch is just a bunch of free hypermultiplets and the important question is to study its Hyperkahler metric. The Coulomb branch is particularly interesting: the IR theory at a generic point of the moduli space is an abelian gauge theory and the important task is to find out the photon couplings; there are also various singular points with extra massless particles where the IR theory is much more non-trivial. Seiberg-Witten discovered that for some theories the low energy effective theory on the Coulomb branch could be described by a Seiberg-Witten curve fibered over the moduli space:

$$F(x, z, \lambda_j) = 0; \tag{2.1}$$

Here λ s are the parameters including coupling constants, mass parameters, and expectation values for Coulomb branch operators. The period integral of an appropriate one form over the Riemann surface $F(x, z, \lambda) = 0$ with fixed λ determines the low energy photon coupling. The SW curve contains a lot more information such as the central charge for BPS particles, the physics at the singularities on the parameter space, etc.

²We might need to put some constraints on (c, c) ring.

³This point has been emphasized to us by C.Vafa.

So one of the most important task of studying a $\mathcal{N} = 2$ SCFT is to find its SW curve for the Coulomb branch. It was soon realized that string theory provides the most efficient way of solving a theory. One approach is to first engineer UV theory using the type IIA brane configuration and then lifting IIA configuration to a M5 brane configuration to find the SW curve [4], and this might be regarded as an open string method. The other approach is to first put type IIA string theory on a singularity to engineer a UV theory, and its SW solution is found by mirror type IIB geometry [13, 14]. One of the interesting fact about the second approach is that the SW solution of some theories can only be put in a three-fold fibration $F(z_0, z_1, z_2, z_3, \lambda) = 0$, and this suggests that the most general SW solution should be a three-fold fibration rather than a curve fibration!

Instead of starting with a UV gauge theory using type IIA theory and then try to find its SW solution using type IIB mirror, we directly try to classify all possible three fold fibration in type IIB side which can give the SW solution of a SCFT. The task is significantly simplified as it appears that the most singular points namely the SCFT point on the Coulomb branch completely determine the full SW solution, so the task of classifying a $\mathcal{N} = 2$ SCFT is reduced to classify all possible three-fold singularity! In this section, we focus on isolated hypersurface singularity.

2.1 Constraint on hypersurface singularity

Let's start with an isolated hypersurface singularity (IHS) $f : (\mathbb{C}^4, 0) \rightarrow (\mathbb{C}, 0)$, and here we summarize the condition on f that would give rise to a SCFT [16]:

- f has an isolated singularity at $z_i = 0$, $i = 0, 1, 2, 3$, which means that $f = \frac{\partial f}{\partial z_0} = \frac{\partial f}{\partial z_1} = \frac{\partial f}{\partial z_2} = \frac{\partial f}{\partial z_3} = 0$ has a unique solution at $z_i = 0$.
- 4d $\mathcal{N} = 2$ SCFT has a $U(1)_R$ symmetry, which means that the polynomial f has to have a \mathbb{C}^* action such that all the coordinates have positive weights:

$$f(\lambda^{q_i} z_i) = \lambda f(z_i), \quad q_i > 0; \quad (2.2)$$

such polynomial is called quasi-homogenous polynomial. The $U(1)_R$ charge of 4d SCFT is proportional to this \mathbb{C}^* action and the proportional constant will be determined later.

- To get a sensible SCFT, the weights has to satisfy the following condition:

$$\sum q_i > 1; \quad (2.3)$$

The third condition could be understood using string theory. Consider type IIB string theory on following background $R^{1,3} \times X^3$, where X^3 is an isolated three dimensional hypersurface singularity defined by f . It is argued in [29, 30] that in taking string coupling g_s and string scale l_s to zero, we get a non-trivial four dimensional SCFT. If we keep l_s to be finite, we get a little string theory which has a holographic description on background $R^{1,3} \times R_\phi \times S^1 \times LG(W = f)$ with proper orbifolding, here R_ϕ is the linear dilaton sector. To have a stable string theory, we require that the central charge $\hat{c} < 2$ for the Landau-Ginzburg piece. The central charge \hat{c} for the LG model defined by the superpotential $W = f$ is $4 - 2 \sum q_i$, so $\hat{c} < 2$ condition is the same as $\sum q_i > 1$ condition.

2.2 Mini-versal deformation and Seiberg-Witten solution

Let's start with a IHS with a \mathbb{C}^* action, and assume the weights satisfy the condition $\sum q_i > 1$ so we expect to get a 4d $\mathcal{N} = 2$ SCFT. The SW geometry is related to the deformation of the singularity f , and there is a distinguished class of deformations called mini-versal deformations which can be identified with the SW geometry. In the hypersurface case, the mini-versal deformation can be described easily and this is one of the most powerful advantage of using singularity to define a SCFT.

Let's now describe explicitly the form of mini-versal deformations: given a quasi-homogeneous polynomial f with an isolated singularity at the origin, we can define the following Jacobi algebra:

$$J(f) = \mathbb{C}[z_0, z_1, z_2, z_3] / \left(\frac{\partial f}{\partial z_0}, \frac{\partial f}{\partial z_1}, \frac{\partial f}{\partial z_2}, \frac{\partial f}{\partial z_3} \right); \quad (2.4)$$

here $\mathbb{C}[z_0, z_1, z_2, z_3]$ is the polynomial ring of \mathbb{C}^4 , and the above algebra has finite dimension μ since f has an isolated singularity. Let's take $\phi_1(z), \dots, \phi_\mu(z)$ as the monomial basis of the above Jacobi algebra, then the Seiberg-Witten solution is given by:

$$F(z, \lambda) = f(z_0, z_1, z_2, z_3) + \sum_{i=1}^{\mu} \lambda_i \phi_i(z) = 0; \quad (2.5)$$

There is also a canonically defined SW differential:

$$\Omega = \frac{dz_0 \wedge dz_1 \wedge dz_2 \wedge dz_3}{dF}. \quad (2.6)$$

Let's use z^α to denote one basis vector of the Jacobi algebra, and u_α to denote the coefficient before the monomial in SW geometry. The coefficient u_α corresponds to physical parameter that would deform Coulomb branch of a $\mathcal{N} = 2$ SCFT.

The scaling dimension of $\Delta(u_\alpha)$ can be easily found from the charge Q_α of z^α under the \mathbb{C}^* action presented in 2.2. The $U(1)_R$ charge is proportional to the charge under \mathbb{C}^* action, and so the scaling dimension of an operator on Coulomb branch is also proportional to its \mathbb{C}^* charge as those operators are chiral primary. Based on above fact, we assume that the scaling dimension Δ of an operator is proportional to the \mathbb{C}^* charge: $\Delta = \delta Q_\alpha$. δ can be found using the following condition: the canonical differential Ω has Q charge ($\sum q_i - 1$), and Ω is required to have scaling dimension 1 as the integration of this three form on three cycles would give the mass for the BPS particle, so we have $(\sum_{i=0}^3 q_i - 1)\delta = 1$, and we find

$$\delta = \frac{1}{\sum_{i=0}^3 q_i - 1} = \frac{2}{2 - \hat{c}}. \quad (2.7)$$

with $\hat{c} = 4 - 2 \sum_{i=0}^3 q_i$, here \hat{c} is the normalized central charge for the two dimensional (2,2) Landau-Ginzburg model defined by f . For a deformation $u_\alpha z^\alpha$, the \mathbb{C}^* charge of u_α is $1 - Q_\alpha$ so that the total weights of this deformation term is one, then the scaling dimension of u_α is

$$[u_\alpha] = (1 - Q_\alpha)\delta = \frac{1 - Q_\alpha}{\sum q_i - 1} = \frac{2(1 - Q_\alpha)}{2 - \hat{c}}. \quad (2.8)$$

Notice that generically there could be deformations whose coefficients have negative scaling dimensions.

The Jacobi algebra plays a crucial role in defining the mini-versal deformations, and the Poincare polynomial of the algebra $J(f)$ can be computed using the weights information. To define this polynomial, we introduce the following equivalent \mathbb{C}^* action

$$f(\lambda^{w_0} z_0, \dots, \lambda^{w_3} z_3) = \lambda^d f(x_0, \dots, x_n). \quad (2.9)$$

Now the weights w_i and degree d are all positive integers, and one can recover previous weights using the relation $q_i = \frac{w_i}{d}$. Define the Poincare polynomial based on \mathbb{C}^* action

$$P(t) = \sum_{\alpha} (\dim H_{\alpha}) t^{\alpha}; \quad (2.10)$$

Here α is the weight of \mathbb{C}^* action and $\dim H_{\alpha}$ is the dimension of the subspace with charge α . The Poincare polynomial is [23]:

$$P(t) = \prod_{i=0}^3 \frac{1 - t^{d-w_i}}{1 - t^{w_i}}. \quad (2.11)$$

The dimension of Jacobi algebra is then

$$\mu = \prod_{i=0}^3 \left(\frac{d}{w_i} - 1 \right) = \prod_{i=0}^3 \left(\frac{1}{q_i} - 1 \right); \quad (2.12)$$

and the maximal degree of the monomial basis vector is

$$d_{max} = 4d - 2 \sum w_i. \quad (2.13)$$

The minimal degree is obviously zero.

There are several simple comments on the possible spectrum:

- The deformations are paired except for the deformation with scaling dimension 1, and these pairs satisfy the following condition

$$[m] + [u] = 2; \quad (2.14)$$

This is required by $\mathcal{N} = 2$ supersymmetry.

- There is a unique operator with highest scaling dimension which is given by the constant deformation $\lambda \cdot 1$, and its scaling dimension is

$$[u]_{max} = 2/(2 - \hat{c}). \quad (2.15)$$

The spectrum of operators with positive scaling dimensions could be classified according to their scaling dimensions:

- $[u] > 1$: Coulomb branch operators, and this happens if $Q_{\alpha} < \frac{\hat{c}}{2}$. Among them, we call an operator with scaling dimension $1 < [u] < 2$ relevant operator.

- The deformation $[u] = 1$ is called mass parameter, this happens if $Q_\alpha = \frac{\hat{c}}{2}$.
- The deformation $0 \leq [u] < 1$ are called coupling constants, and this happens if $Q_\alpha > \frac{\hat{c}}{2}$; An operator with scaling dimension $[u] = 0$ is called exact marginal deformation, and this happens if $Q_\alpha = 1$.

In the following we use r to denote the number of deformations with scaling dimension bigger than one, and r is called dimension of the Coulomb branch; We also use f to denote the number of deformations with scaling dimension one which are mass parameters. The rank of the charge lattice of the theory is then

$$R = 2r + f = \mu; \tag{2.16}$$

and the relation between the dimension of Jacobi algebra and the rank of the charge lattice is due to the pairing of mini-versal deformations.

Let's make some comments on the spectrum of the theory engineered using hypersurface singularity: first, all kinds of possibilities can happen: it is possible to have mass parameters or not to have mass parameters; it is possible to have the exact marginal deformations or not have exact marginal deformations; the theory can have relevant or not have relevant operators. If there is an exact marginal deformation in our theory, it is possible to find a weakly coupled gauge theory description and it is interesting to study the S duality behavior of the theory; If the theory has mass parameters, it is interesting to study whether there is non-abelian flavor symmetry, etc.

One could try to classify $\mathcal{N} = 2$ SCFT based on the property of the spectrum on the Coulomb branch:

- One could classify the theory based on the dimension of the Coulomb branch (the number of operators on Coulomb branch with scaling dimension bigger than one). An attempt of trying to classify rank one theory based on Kodaira's classification of singular elliptic fibre has been given in [31]. Some of them can be realized using IHS:

$$\begin{aligned} H_0 : f &= z_0^2 + z_1^2 + z_2^2 + z_3^3, \\ H_1 : f &= z_0^2 + z_1^2 + z_2^2 + z_3^4, \\ H_2 : f &= z_0^2 + z_1^2 + z_2^3 + z_3^3. \end{aligned} \tag{2.17}$$

It is interesting to classify all rank one, rank two theories which can be realized by IHS.

- One could also classify the theory based on the number of irrelevant and exact marginal deformations of the mini-versal deformations. For SCFT without any marginal and irrelevant deformations in mini-versal deformation, one has the fol-

lowing ADE sequences and their SW solutions:

$$\begin{aligned}
A_k: \quad & f = z_0^2 + z_1^2 + z_2^2 + z_3^{k+1}, \\
& F(z, \lambda) = f + \lambda_1 + \lambda_2 z_3 + \dots + \lambda_k z_3^{k-1}; \\
D_k: \quad & f = z_0^2 + z_1^2 + z_2^{k-1} + z_2 z_3^2, \\
& F(z, \lambda) = f + \lambda_1 + \lambda_2 z_3 + \lambda_3 z_2 + \dots + \lambda_k z_2^{k-2}; \\
E_6: \quad & f = z_0^2 + z_1^2 + z_2^3 + z_3^4, \\
& F(z, \lambda) = f + \lambda_1 + \lambda_2 z_2 + \lambda_3 z_3 + \lambda_4 z_3^2 + \lambda_5 z_2 z_3 + \lambda_6 z_2 z_3^2; \\
E_7: \quad & f = z_0^2 + z_1^2 + z_2^3 + z_2 z_3^3, \\
& F(z, \lambda) = f + \lambda_1 + \lambda_2 z_2 + \lambda_3 z_3 + \lambda_4 z_3^2 + \lambda_5 z_3^3 + \lambda_6 z_3 z_2^2 + \lambda_7 z_2 z_3; \\
E_8: \quad & f = z_0^2 + z_1^2 + z_2^3 + z_3^5. \\
& F(z, \lambda) = f + \lambda_1 + \lambda_2 z_2 + \lambda_3 z_3 + \lambda_4 z_3^2 + \lambda_5 z_3^3 + \lambda_6 z_2 z_3 + \lambda_7 z_2 z_3^2 + \lambda_8 z_2 z_3^3; \quad (2.18)
\end{aligned}$$

These ADE Argyres-Douglas SCFTs are found as the maximal singular point at the corresponding pure $\mathcal{N} = 2$ ADE gauge theory [7]. The next class would be the SCFT whose spectrum consists of operators with **non-negative** scaling dimension. Those theories are actually called complete theory in [32]. In general, we would try to classify the theory by the number of deformations with non-positive scaling dimensions, and we denote this number as m . This number is actually the modality in singularity theory [23].

Example: Let's consider the singularity $f = z_0^a + z_1^b + z_2^c + z_3^d$ with the constraint $\frac{1}{a} + \frac{1}{b} + \frac{1}{c} + \frac{1}{d} > 1$, and the Milnor number is $\mu = (a-1)(b-1)(c-1)(d-1)$. The relation from Jacobi ideal generated by $\frac{\partial f}{\partial z_i} = 0$ is simply

$$z_0^{a-1} = 0, \quad z_1^{b-1} = 0, \quad z_2^{c-1} = 0, \quad z_3^{d-1} = 0. \quad (2.19)$$

So the corresponding Jacobi algebra has the following monomial basis:

$$z_0^\alpha z_1^\beta z_2^\gamma z_3^\delta, \quad 0 \leq \alpha \leq a-2, \quad 0 \leq \beta \leq b-2, \quad 0 \leq \gamma \leq c-2, \quad 0 \leq \delta \leq d-2, \quad (2.20)$$

The total dimension of this algebra is $(a-1)(b-1)(c-1)(d-1)$. The scaling dimension of the coefficient for the above deformation is

$$[u]_{\alpha\beta\gamma\delta} = \frac{1 - (\frac{\alpha}{a} + \frac{\beta}{b} + \frac{\gamma}{c} + \frac{\delta}{d})}{\frac{1}{a} + \frac{1}{b} + \frac{1}{c} + \frac{1}{d} - 1}. \quad (2.21)$$

2.3 Discriminant locus, bifurcation diagram and extra massless particles

Let $f : (\mathbb{C}^4, 0) \rightarrow (\mathbb{C}, 0)$ be a IHS defining a $\mathcal{N} = 2$ SCFT, and let's denote the basis of the Jacobi algebra as $\phi_\alpha(z)$, $\alpha = 1, \dots, \mu$; The miniversal deformation of f is written as

$$F(z, \lambda) = f(z) + \sum_{i=0}^{\mu-1} \lambda_\alpha \phi_\alpha(z) = 0; \quad (2.22)$$

here we take $\phi_0(z) = 1$. The parameters λ_i control the deformation of SCFT in Coulomb branch (some of λ_i are coupling constants, and we treat them at the same footing as the operator with dimension larger than one as they all could change the low energy effective theory). The subspace Σ on S at which $F(z, \lambda)$ is singular is called as the discriminant locus. It is known that Σ is an irreducible hypersurface and its multiplicity is equal to the Milnor number μ , see figure. 1. On the space $S' = S/\Sigma$, the fibre is non-singular, and its only non-vanishing homology class is H^0 and H^3 . An amazing fact about the non-singular fibre is that it is a bouquet of μS^3 , so one can get BPS particle by wrapping $D3$ branes on these S^3 s.

At the discriminant locus Σ , some of the S^3 have vanishing area, and there are extra massless particles coming from D3 brane wrapping on vanishing cycle. The IR theory would be quite different at those special points. The study of the the structure of discriminant locus is an important part in understanding the interesting dynamics of a $\mathcal{N} = 2$ theory. In singularity theory, the structure of the discriminant locus is called bifurcation diagram which is also a quite important subject. The result from singularity literature could definitely teach us about the dynamics of $\mathcal{N} = 2$ theory.

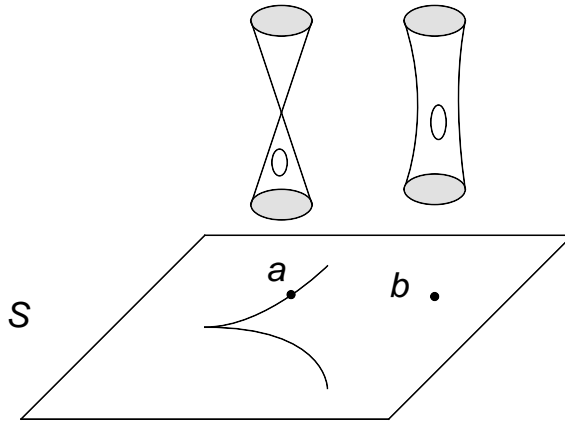

Figure 1. S : the Coulomb branch moduli space for $\mathcal{N} = 2$ theory. Here the curve on S means the discriminant locus; a is a point on which the Milnor fiber becomes singular, b is a point where the Milnor fiber is smooth.

Example: Let's consider A_2 AD theory defined by the IHS $f = z_0^2 + z_1^2 + z_2^2 + z_3^3$, and the mini-versal deformation of this singularity is $z_0^2 + z_1^2 + z_2^2 + z_3^3 + \lambda_1 z_3 + \lambda_2 = 0$. The quadratic terms will not change the discriminant locus, and we can focus on the geometry $z_3^3 + \lambda_1 z_3 + \lambda_2 = 0$, and the discriminant locus is given by the equation

$$\lambda_1^3 + \frac{27}{4}\lambda_2^2 = 0. \quad (2.23)$$

which is simply the condition that the roots of the above cubic equations are degenerate, see illustration in figure. 2.

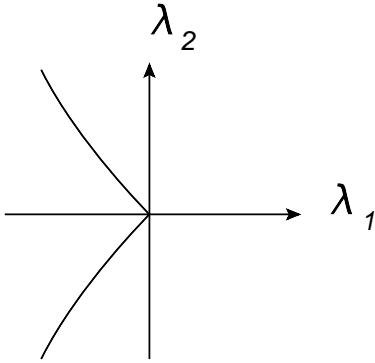

Figure 2. The discriminate locus of A_2 SCFT, here the parameters λ_1, λ_2 are taken to be real.

2.4 Period integral and low energy effective action

Let's denote the moduli space as S , and the discriminant locus as Σ . The hypersurface $F(z, \lambda) = 0$ over fixed λ is smooth away from Σ , see figure. 1. This is called central Milnor fibration whose middle homology $H^3(F_\lambda, C)$ has dimension μ , which is called the Milnor number.

We would like to understand the low energy spectrum from type IIB string theory point of view. Type IIB string theory has a self-dual four form $A_{\mu\nu\rho\sigma}$, and if we compactify IIB string theory on a compact Calabi-Yau manifold, we get $h^{2,1}$ vector multiplet. This is due to the fact that there is a hodge structure on the manifold such that $h^{2,1} = h^{1,2}$, and the self-duality condition could be solved automatically by this Hodge structure. In our current context, there is no standard Hodge structure, but one can define a mixed Hodge structure [24]. We do not explain the detail about mixed hodge structure here, and we just point out a crucial fact that the paired hodge number is nothing but r which is equal to the dimension of the coulomb branch (number of operators with scaling dimension bigger than one). The unpaired Hodge number is equal to the number of mass parameters. With this Hodge structure, we now have r vector multiplets in four dimension from compactification of self-dual four form. From $\mathcal{N} = 2$ field theory point of view, at a non-singular point of the moduli space S , the IR theory is described by a $U(1)^r$ gauge theory.

The low energy coupling for the photons is related to the period integral associated with the $\mathcal{N} = 2$ geometry. Let's discuss this period integral in more detail: take the vector space of middle homology of the Milnor fibration, one can get a homology bundle; Similarly, take the vector space of middle cohomology, one can a cohomology bundle. The period integral is basically a pairing between the cohomology bundle and homology bundle. Let's take a continuous integral basis $\delta_1(\lambda), \dots, \delta_\mu(\lambda)$ of the middle homology group of Milnor fibration, and one can form the following period integral:

$$\lambda \rightarrow \left(\int_{\delta_1(\lambda)} \Omega, \dots, \int_{\delta_\mu(\lambda)} \Omega \right). \quad (2.24)$$

Here $\Omega = \frac{dz_0 \wedge dz_1 \wedge dz_2 \wedge dz_3}{dF(z, \lambda)}$ is the canonical holomorphic three form on the fibre. The low energy effective action of the theory could be read from the information of these period

integrals. There is an intersection form (possibly degenerate) on the middle homology, and we can choose a basis such that they have the following intersection form:

$$\begin{aligned} A^i \cdot B_j &= \delta_{ij}, \quad i = 1, 2, \dots, r; \\ L_\alpha \cdot A^i &= 0, \quad L_\alpha \cdot B_i = 0, \quad L_\alpha \cdot L_\beta = 0, \quad \alpha = 1, \dots, f. \end{aligned} \tag{2.25}$$

Locally on the moduli space, We might identify the periods as the electric, magnetic and the mass coordinates on the moduli space:

$$\begin{aligned} a^i(\lambda) &= \int_{A^i(\lambda)} \Omega, \quad a_i^D(\lambda) = \int_{B_i(\lambda)} \Omega, \\ m_\alpha(\lambda) &= \int_{L_\alpha(\lambda)} \Omega. \end{aligned} \tag{2.26}$$

In this basis, the photon coupling would be

$$\tau^{ij} = \frac{da_i^D}{du_k} \frac{du_k}{da^i}, \quad i, j = 1, \dots, r. \tag{2.27}$$

Here u_i are the operators with scaling dimension bigger than one. For IHS and its deformation, these period integral has important property such as holomorphy dependence on the parameters, etc.

2.5 Monodromy, vanishing cycles and BPS quiver

The physical interpretation of the singularity on the base of the miniversal deformation of IHS f is that there are extra massless particles [1]. These massless particles are from the stable massive BPS particles on the non-singular locus of the moduli space. From type IIB string point of view, the BPS particle comes from D3 brane wrapping on special Lagrangian three cycle of the geometry $F(z, \lambda) = 0$, and therefore the existence of extra particle is related to the vanishing cycle on the singularity.

To make this picture more precise, let's focus on co-dimensional one singularity on S . Let's fix a point s_0 and form a path $\alpha(t)$ connecting s_0 and a co-dimension one singularity. Certain three cycle becomes vanishing along the path, see figure. 3. One get an extra massless particles from D3 brane wrapping on this vanishing cycle.

There is a monodromy action on the homology of the fibration which is associated with the loop β_i around one singularity s_i , see figure. 3. The monodromy action is given by the Picard-Lefschetz transformation:

$$T_i(x) = x + \langle x, \Delta_i \rangle \Delta_i, \tag{2.28}$$

here x is an element of integral homology and Δ_i is the vanishing cycle, and $\langle x, \Delta_i \rangle$ is the intersection number between x and Δ_i . Considering the period integral, we have the following monodromy transformation

$$\int_x \Omega \rightarrow \int_{x + \langle x, \Delta_i \rangle \Delta_i} \Omega = \int_x \Omega + \langle x, \Delta_i \rangle \int_{\Delta_i} \Omega; \tag{2.29}$$

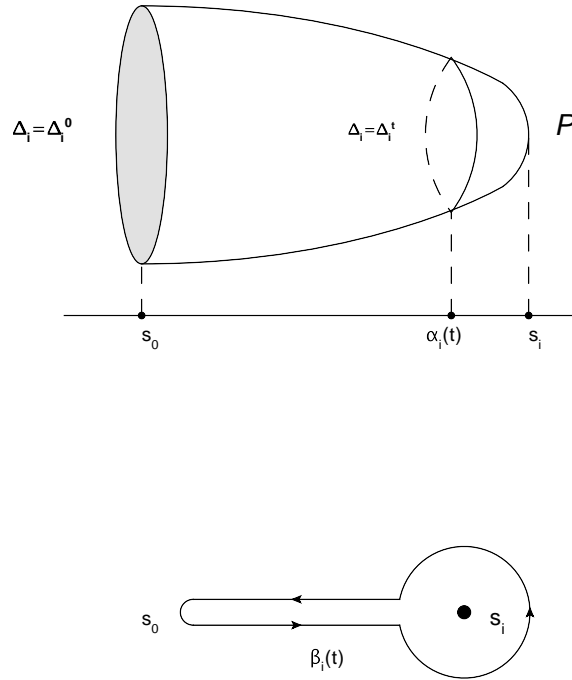

Figure 3. Up: The three cycle becomes vanishing cycle in approaching the singular point s_i . Bottom: A path around the singular point on the moduli space.

These are just the electric-magnetic duality actions on the low energy effective $U(1)$ theories.

More generally, for IHS, one can turn on deformations such that there are a total of μ codimensional one singularities. These singularities are the so-called A_1 singularity around which the equation can be denoted as

$$z_0'^2 + z_1'^2 + z_2'^2 + z_3'^2 = \lambda_0; \quad (2.30)$$

here z_i' is the local coordinates around the singularity. This kind of deformation is called Morsification of the singularity. Let's fix a point s_0 which is sufficiently closed to origin. One can choose a line L close to the origin which meets discriminant Σ in μ points s_1, \dots, s_μ . We can take a non self-intersecting path α_i from a fixed point s_0 to s_i , see figure. 4. The ordering of s_i and α_i is given by rule such that they start from s_0 and counting clockwise. Since each path gives us a vanishing cycle, we therefore get a ordered basis $\Delta_i, i = 1, \dots, \mu$ of the middle homology of the Milnor fibration. Given these paths, one can form a bunch of loops which generate $\pi_1(S/\Sigma)$ and there is a total monodromy

$$T = T_1 T_2 \dots T_\mu. \quad (2.31)$$

This monodromy matrix plays an important role in characterizing the singularity.

The above product of the monodromy is related to the total monodromy of singularity, which is defined using a so-called Milnor fibration. The Milnor fibration is defined as follows: Let's take a disc $D_\delta = \{t \in \mathbb{C}; 0 < |t| < \delta\}$, and the Milnor fibration associated

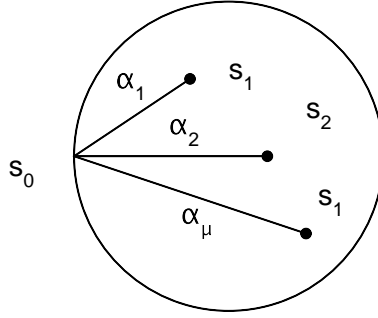

Figure 4. A set of loops around various A_1 singularities, and these generate the π_1 of the base of the fibration.

with a IHS is

$$\Psi : \{|z_0|^2 + |z_1|^2 + |z_2|^2 + |z_3|^2 = \epsilon^2\} \cap f^{-1}(D_\delta) \rightarrow D_\delta. \quad (2.32)$$

This map is a topologically locally trivial fibration for any $\epsilon \gg \delta > 0$. It is not hard to see that this fibration is the fibration around the origin of the Coulomb branch by turning on constant deformation. Choosing a small cycle around the origin, then the monodromy acts on the homology of the Milnor fibration as

$$T : H_3(\Psi^{-1}(t), C) \rightarrow H_3(\Psi^{-1}(t), C). \quad (2.33)$$

This monodromy group is just the one defined earlier using the Picard-Lefschetz transformations around co-dimensional one singularity. There are several important features about the monodromy:

- The eigenvalues of the monodromy matrix is a root of unity, and the eigenvalues are related to basis of Jacobi algebra. Consider a monomial basis z^α , then the eigenvalue associated with it is $\exp(2\pi i l_i)$ with

$$l_i = \sum_{j=0}^3 (n_j + 1) q_j - 1, \quad (2.34)$$

here n_j is the exponent of z^α . It is easy to check that the number of unity eigenvalues is equal to the number of mass parameters by noting the following two facts: a: $l_i = 1$ gives us a mass parameter; b: $0 < l_i < 2$.

- The monodromy matrix satisfies the condition $(T^N - I)^k = 0$ for some N and k , namely $(T^N - I)$ is an nilpotent matrix.

Those vanishing cycles are the distinguished basis of the middle homology of the Milnor fibration. The important data is the intersection form on the set $(\Delta_1, \dots, \Delta_\mu)$, and one can form an antisymmetric intersection matrix as follows:

$$\begin{aligned} I_\Delta = & \langle \Delta_i, \Delta_j \rangle_{1 \leq i, j \leq \mu, i \neq j} \\ & \langle \Delta_i, \Delta_i \rangle = 0 \end{aligned} \quad (2.35)$$

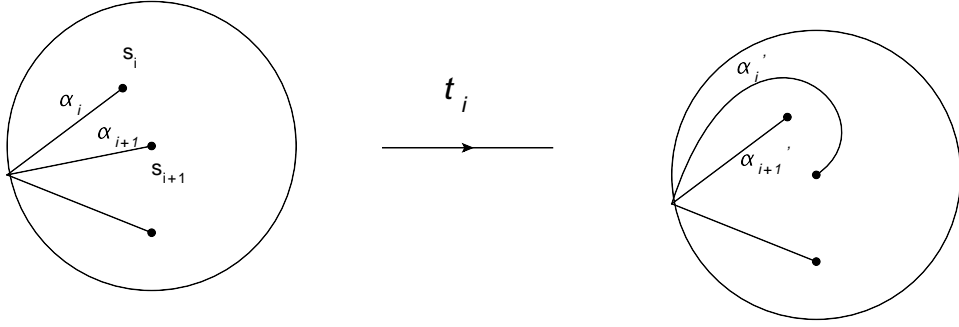

Figure 5. Braiding operation which changes the basis of vanishing cycle.

These intersection form depends on the choices of paths and is not unique. There are two operations which can be used to change the basis. The first operation is to change the orientation of the cycle:

$$s_i : (\Delta_1, \dots, \Delta_i, \dots, \Delta_\mu) \rightarrow (\Delta_1, \dots, -\Delta_i, \dots, \Delta_\mu) \quad (2.36)$$

The second transformation is more nontrivial, and it acts the path by the so-called braiding, and see figure. 5 for how the path is changed. The basis is changed as

$$t_i : (\Delta_1, \dots, \Delta_i, \Delta_{i+1}, \dots, \Delta_\mu) \rightarrow (\Delta_1, \dots, \Delta_{i+1} + \langle \Delta_{i+1}, \Delta_i \rangle \Delta_i, \Delta_i, \dots, \Delta_\mu) \quad (2.37)$$

It is straightforward to derive the change of the intersection form under this change of basis.

We now conjecture that the intersection form of vanishing cycle might be identified with the BPS quiver. Let's choose the distinguished basis and perform the period integral

$$\lambda \rightarrow \left(\int_{\Delta_1(\lambda)} \Omega, \dots, \int_{\Delta_\mu(\lambda)} \Omega \right) = (a_1(\lambda), \dots, a_\mu(t)). \quad (2.38)$$

Consider a special Lagrangian three cycle in Homology class $L = n_1 \Delta_1 + \dots n_\mu \Delta_\mu$, then the central charge of it is given by the integral of (3,0) form on L

$$Z = \int_L \Omega = \int_{\sum n_i \Delta_i} \Omega = \sum n_i a_i. \quad (2.39)$$

Due to special Lagrangian condition, the mass of this particle is equal to the absolute value of the central charge. The task of counting BPS spectrum is to determine which n_i are allowed in certain region of the moduli space, and study the wall crossing behavior of various BPS particles. The BPS quiver plays a crucial role in finding the spectrum, so knowing the BPS quiver is a first step. For many known theories in this class, the BPS quiver is actually the intersection form of the vanishing cycle [17? –19], and we would like to conjecture that this fact is true for all the theories defined by IHS, other evidences will be given elsewhere.

We hope that the combination of geometric interpretation of the BPS quiver and the representation theory of the quiver would give us more information about the full BPS spectrum of these theories.

Example: Consider A_2 SCFT, the Milnor number is 2, and the intersection form associated with vanishing cycle is $\langle \Delta_1, \Delta_2 \rangle = 1$. The monodromy group can be easily found using Picard-Lefschetz transformation:

$$\begin{aligned} T_1 &= \begin{pmatrix} 1 & 0 \\ 1 & 1 \end{pmatrix}, \\ T_2 &= \begin{pmatrix} 1 & -1 \\ 0 & 1 \end{pmatrix}, \\ T &= T_1 T_2 = \begin{pmatrix} 1 & -1 \\ 1 & 0 \end{pmatrix}. \end{aligned} \tag{2.40}$$

2.6 Central charge a and c

For four dimensional conformal field theory, there are two important central charges a, c which measure the degree of freedom of a theory, usually it is pretty difficult to compute those quantities. For $\mathcal{N} = 2$ SCFTs, the central charges can be computed using various methods such as free theory limit, three dimensional mirror, etc. Here we are going to give an extremely simple formula for the central charges for all the theory defined using IHS.

The formula which we are going to use is the one discovered in [33]:

$$a = \frac{R(A)}{4} + \frac{R(B)}{6} + \frac{5r}{24} + \frac{h}{24}, \quad c = \frac{R(B)}{3} + \frac{r}{6} + \frac{h}{12}, \tag{2.41}$$

Here $R(A)$ is given by the Coulomb branch spectrum consists of operators with scaling dimension bigger than one:

$$R(A) = \sum_i ([u_i] - 1), \tag{2.42}$$

and r, h are the number of free vector multiplets and free hypermultiplets at the generic point of Coulomb branch. Notice that there is no free hypermultiplet for the class of theories we considered in this paper, which can be verified by the fact that there is only non-vanishing middle homology class. The above remarkable formula is derived using the topological twisting of a $\mathcal{N} = 2$ theory [33, 34].

For theories defined by IHS, $R(A)$ and r can be easily found from the mini-versal deformation; Using the deformation pattern of singularity theory, we are going to give a simple formula for $R(B)$. $R(B)$ is related to the co-dimensional one singularity on which there is an extra massless hypermultiplet, and is given by the R charge of local coordinate near such singularity $\frac{1}{4}R(\delta z)$. $R(B)$ is the sum of contribution from all co-dimensional one singularities:

$$R(B) = \mu \frac{1}{4} R(\delta z); \tag{2.43}$$

Here μ is the number of co-dimensional one singularity, $R(\delta z)$ is the R charge of the local coordinates. The crucial fact for us is that there are a total of μ co-dimension one A_1 singularity at the Coulomb branch [25]. Near the singularity, the three fold takes the following simple form:

$$\delta z_0^2 + \delta z_1^2 + \delta z_2^2 + \delta z_3^2 = \lambda_0. \tag{2.44}$$

We would like to know the $U(1)_R$ charge of the local coordinates δz_i . It is easy to see that this singularity is the A_1 singularity which represents a massless hypermultiplet. The only deformations are constant deformation whose scaling dimension is

$$\Delta(\lambda_0) = \frac{2}{2 - \hat{c}}, \quad (2.45)$$

so the local coordinates δz_i has scaling dimension $[\delta z_i] = \frac{1}{2}\Delta(\lambda_0)$ and therefore its $U(1)_R$ charge is $R(\delta z_i) = 2[\delta z_i] = \frac{2}{2 - \hat{c}}$, so $R(B)$ is equal to

$$R(B) = \frac{\mu}{2(2 - \hat{c})} = \frac{\mu}{4(\sum q_i - 1)} = \frac{1}{4}\mu[u]_{max}. \quad (2.46)$$

Here $[u]_{max}$ is the operator with maximal scaling dimension on the Coulomb branch.

Example I: Let's check our formula for the simplest theory defined by $f = z_0^2 + z_1^2 + z_2^2 + z_3^2$, and this is the free hypermultiplet. The "Coulomb branch" is described by the formula $F = z_0^2 + z_1^2 + z_2^2 + z_3^2 + \lambda$, and λ has scaling dimension one, so $R(A) = 0$. There is only one A_1 singularity on the origin, so $R(B) = \frac{1}{4}$. We have $r = h = 0$, and using the formula in 2.41, we find the central charge

$$a = \frac{1}{24}, \quad c = \frac{1}{12}. \quad (2.47)$$

This is nothing but the central charge for a free hypermultiplet.

Example II: Let's check our formula for a more complicated example. The singularity is given by $f = z_0^3 + z_1^3 + z_2^3 + z_3^{3k}$, and the Milnor number is $\mu = 8(3k - 1)$. Using singularity and its mini-versal deformation, we find:

$$R(A) = -6k + 12k^2, \quad R(B) = 6k(3k - 1), \quad r = 12k - 7, \quad (2.48)$$

and the central charge is given by

$$a = 6k^2 - \frac{35}{24}, \quad c = 6k^2 - \frac{7}{6}. \quad (2.49)$$

It is known [20] that this is affine E_6 quiver gauge theory, see figure. 6 for the quiver. This theory has a Lagrangian description and its central charge can be easily found using the following formula

$$a = \frac{n_h}{24} + \frac{5n_v}{24}, \quad c = \frac{n_h}{12} + \frac{n_v}{6}. \quad (2.50)$$

Substitute $n_h = 24k^2$, $n_v = 24k^2 - 7$ into above formula, we find

$$a = 6k^2 - \frac{35}{24}, \quad c = 6k^2 - \frac{7}{6}; \quad (2.51)$$

which agrees with the result derived above using totally different method.

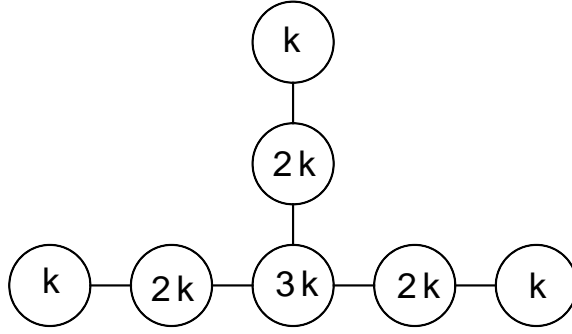

Figure 6. Lagrangian description for the singularity $f = z_0^3 + z_1^3 + z_2^3 + z_3^{3k}$.

2.7 Exact marginal deformations, duality group and moduli of singularity

If we can find a monomial z^α with weights 1 in the monomial basis of Jacobi algebra, there is an exact marginal deformation in our theory. The space of exact marginal deformations is therefore identified with the following family of singularity.

$$f(z_0, z_1, z_2, z_3) + \sum \lambda_\alpha z^\alpha = 0, \quad (2.52)$$

Here the sum is over the monomials with weight 1. This family of deformations have a distinguished feature that the Milnor number is constant along this deformation (notice that the irrelevant deformation also gives rise to μ constant deformation). The coupling constant space is therefore identified as \mathbb{C}^p , where p is the number of weight one deformations. However, these points do not give singularity with different complex structures as two different number λ and λ' could give bi-holomorphic equivalent singularity. An important question is to determine an invariant function so that two isomorphic coupling constant would give the same answer (this is the analog of the J invariant for the elliptic curve). After finding the invariant, one can find out the modular group G and the the space of exact marginal deformations is therefore \mathbb{C}^p/G . This G is nothing but the duality group.

On the other hand, the equation defines a weighted homogeneous variety if we quotient the above hypersurface by the defining \mathbb{C}^* action, therefore the space of exact marginal deformations are the space of complex structure deformations of the corresponding variety. This is a generalization of class \mathcal{S} theory in which the space of exact marginal deformations are identified with the complex structure moduli of curves, here we would find the complex structure moduli space of surfaces.

Whenever there is an exact marginal deformation, the theory should have a weakly coupled gauge theory description and the exact marginal deformation could be identified with the gauge coupling. It appears that the mirror symmetry for f plays a important role in finding the gauge theory description. The detailed study of space of exact marginal deformation and the gauge theory description of these theories will be left to a separate publication, see also [20, 35, 36] for the studies of gauge theory descriptions of some singularities.

Example I: Let's consider the singularity $f = z_0^2 + z_1^3 + z_2^3 + z_3^3$, and there is one weight one deformation $z_1 z_2 z_3$. So we have a family of singularities $F = z_0^2 + z_1^3 + z_2^3 + z_3^3 + \lambda z_1 z_2 z_3$ with the constraint $\lambda^3 + 27 \neq 0$ so that there is an isolated singularity at the origin. Let's ignore z_0 term as it does not contribute anything to our problem. The projective variety defined by $z_1^3 + z_2^3 + z_3^3 = 0$ is a torus, and λ is the complex structure of this variety. The invariant for this singularity has been calculated by Saito [37]:

$$J(\lambda) = -\frac{\lambda^3(\lambda^3 - 216)^3}{1728(t^3 + 27)}; \quad (2.53)$$

Example II: Let's consider following singularities:

$$\begin{aligned} z_0^3 + z_1^3 + z_2^3 + z_3^3 &= 0, \\ z_0^2 + z_2^4 + z_3^4 + z_3^4 &= 0, \\ z_0^2 + z_2^3 + z_3^6 + z_3^6 &= 0. \end{aligned} \quad (2.54)$$

These IHS define quiver gauge theory of affine E_6, E_7, E_8 shape respectively [14, 20]. The number of exact marginal deformations are 4, 6, 8 respectively. The corresponding weighted projective variety is the smooth Del Pezzo surface dP_6, dP_7, dP_8 respectively. So the space of gauge coupling is identified with the complex structure of those algebraic surfaces.

2.8 RG webs and adjacency of singularity

If there is a relevant deformation in our spectrum, we can turn on this deformation and flow to other theories. Such RG flow has been studied in [38] for some theories, here we will give a more general illustration.

One can turn on a relevant deformation of a $\mathcal{N} = 2$ SCFT and flow to a new fixed point in the infrared, i.e. one can turn on the deformation [6]:

$$\int d^4\theta \frac{\langle v \rangle}{\mu^\sigma} U, \quad (2.55)$$

where $\langle v \rangle$ is the expectation value of certain operator with dimension 1. The coupling constant is identified as $m = \frac{\langle v \rangle}{\mu^\sigma}$ with scaling dimension

$$[m] = 1 - \sigma, \quad (2.56)$$

and the operator U has dimension $[U] = 1 + \sigma$. U is an irrelevant operator when $[U] > 2$, marginal when $[U] = 2$, and relevant when $[U] < 2$. Here U is operator for which we can turn on its expectation value which parameterizes the Coulomb branch. The scaling dimensions of m and U satisfy the relation $[m] + [U] = 2$. We would like to study the IR theory in the limit $\mu \rightarrow 0$.

Let's now consider a SCFT defined by a IHS. If we turn on the relevant deformation m (without turning on the expectation value of U), the curve becomes

$$f(z_0, z_1, z_2, z_3) + \frac{\langle v \rangle}{\mu^\sigma} z^\alpha = 0 \quad (2.57)$$

with $0 < \sigma < 1$ whose value is determined by the monomial z^α . We would like to know the new SCFT at the deep IR, which could be achieved by a scaling limit as we have done in [38].

Here we give a much easier method to determine the IR SCFT. Let's first define a semi-quasihomogeneous isolated singularity f as the following type of polynomial

$$f = f_1 + f_2; \quad (2.58)$$

Here f_1 defines a quasi-homogeneous isolated singularity, and f_2 consists of monomials with weights bigger than one. f_0 is called quasi-homogeneous piece of f . Now let's start with a quasi-homogeneous singularity f_0 , and deform it using relevant deformations, and we have

$$f_{def} = f_0 + f_1. \quad (2.59)$$

If f_{def} is a semi-quasihomogeneous singularity, f_{def} can be written as $f_{def} = f'_1 + f'_2$ and the IR theory is described by the quasi-homogeneous piece f'_1 . Using this method, it is easy to determine the singularity corresponding to the IR theory by turning on relevant deformation m .

More generally we could also form a deformation by turning on deformations involving more than one terms, this means that we also turn on expectation value for operators with scaling dimension bigger than one. For example, let's consider the A_2 singularity and the following deformation

$$\begin{aligned} F(z, t) &= z_0^2 + z_1^2 + z_2^2 + z_3^3 + 3tz_3^2 \rightarrow \\ F(z, t) &= z_0^2 + z_1^2 + z_2^2 + z_3'^3 - 3t^2z_3' + 2t^3, \quad z_3' = z_3 + t. \end{aligned} \quad (2.60)$$

Notice that the deformation in first line is not a form of mini-versal deformation, while the second one is written in the mini-versal deformation form by changing the coordinates. Physically, it means that we turn on the relevant and the coulomb branch expectation value simultaneously. We can take a scaling limit such that z_3^3 term becomes irrelevant, and the new singularity is just the A_1 singularity. Alternatively, since the new singularity is semi-quasihomogeneous, and the quasi-homogeneous piece is just A_1 singularity.

Using the above type of RG flow, one can connect the singularities, in particular, we would like to find two theories whose charge lattice differ by dimension one and they can be connected by a RG flow. This web is the adjacencies of singularities studied by Arnold et al [23], see figure. 7 for an example.

2.9 Summary

Let's summarize how to compute various physical quantities of $\mathcal{N} = 2$ SCFT from singularity theory:

- The SW geometry is given by the mini-versal deformation of the singularity:

$$F(z, \lambda) = f(z) + \sum_{i=1}^{\mu} \lambda_i \phi_i(z) = 0, \quad (2.61)$$

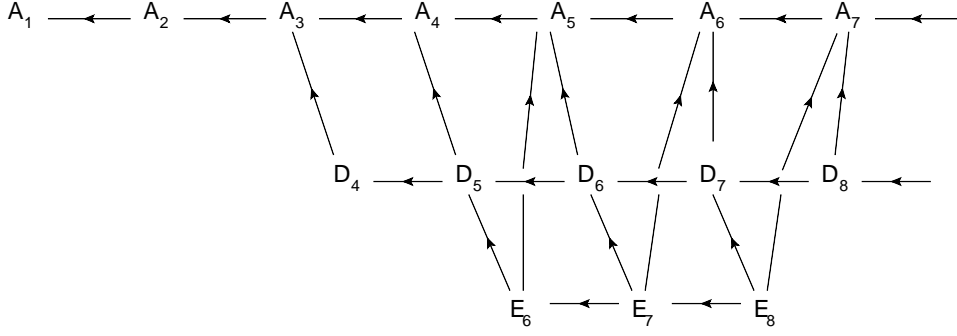

Figure 7. Adjacency of singularities which is interpreted as a RG web.

here ϕ_i is the basis for the Jacobi algebra $J(f) = \mathbb{C}[z_0, z_1, z_2, z_3]/(\frac{\partial f}{\partial z_0}, \frac{\partial f}{\partial z_1}, \frac{\partial f}{\partial z_2}, \frac{\partial f}{\partial z_3})$. The scaling dimension of λ_α is given by the formula:

$$[\lambda_\alpha] = \frac{1 - Q_\alpha}{\sum_{i=1}^3 q_i - 1}. \quad (2.62)$$

- The SW differential is $\Omega = \frac{dz_0 \wedge dz_1 \wedge dz_2 \wedge dz_3}{dF}$ and the low energy effective action is encoded in period integral

$$\lambda \rightarrow \left(\int_{\delta_1(\lambda)} \Omega, \dots, \int_{\delta_\mu(\lambda)} \Omega \right); \quad (2.63)$$

- The monodromy around a co-dimensional one singularity is given by the Picard-Lefschetz transformation,

$$T : x \rightarrow x + \langle x, \Delta_i \rangle \Delta_i. \quad (2.64)$$

- The intersection form on the distinguished basis associated with vanishing cycle is conjectured to be the BPS quiver.

- The central charge a, c can be found using the formula

$$R(A) = \sum_{[u_i] > 1} ([u_i] - 1), \quad R(B) = \frac{\mu}{2(2 - \hat{c})} = \frac{\mu}{4(\sum q_i - 1)}; \\ a = \frac{R(A)}{4} + \frac{R(B)}{6} + \frac{5r}{24}, \quad c = \frac{R(B)}{3} + \frac{r}{6}. \quad (2.65)$$

The Milnor number μ of the singularity plays a crucial role for the physical property of $\mathcal{N} = 2$ theory. Here let's summarize its various meanings:

- It is the dimension of the Jacobi algebra and the dimension of the base of mini-versal deformation of the singularity. Physically, it is equal to the number of deformations (those with negative scaling dimensions are irrelevant deformations) in $\mathcal{N} = 2$ geometry;
- It is equal to the dimension of middle cohomology of Milnor fibration. Physically, it is equal to the dimension of the charge lattice.

- It is equal to the number of co-dimension one A_1 singularity in the mini-versal deformations. Physically, this is equal to the number of co-dimensional one singularity at which there is an extra massless hypermultiplet.

3 Classification of hypersurface singularity

As discussed in last section, the isolated hypersurface singularity $f(z_0, z_1, z_2, z_3)$ which seems to define a $\mathcal{N} = 2$ SCFT has to satisfy the following conditions:

- It has a good \mathbb{C}^* action, namely

$$f(\lambda^{q_i} z_i) = \lambda f_i(z), \quad q_i > 0; \quad (3.1)$$

- The weights satisfy the following condition: $\sum q_i > 1$;

We would like to classify all such hypersurface singularity. Interestingly, same type of singularities have been studied by Yau and Yu [22], and they give a full classification. Mathematically, what they are interested are rational isolated hypersurface singularity with a \mathbb{C}^* action. The rational condition for the hypersurface is nothing but the condition two listed above. In the following, we simply take their results and reorganize them appropriately.

To start with, we first classify isolated hypersurface singularity f with a \mathbb{C}^* action. It is easy to see that in order that there is an isolated singularity at $z_0 = 0$, f has to include one of the following terms $(z_0^k, z_1 z_0^k, z_2 z_0^k, z_3 z_0^k)$. Similar condition is applied to other three variables. So we need to select one monomial within four possibilities for one variable, and there are a total of 256 possibilities. After eliminating the simple equivalence class after permuting the variables, the polynomials are classified into 19 types, see table. 1. The weights q_i of them are listed in table. 1. Once the weights are given, the Milnor number μ is easy to compute, and it is equal to

$$\mu = \prod \left(\frac{1}{q_i} - 1 \right) \quad (3.2)$$

See table. 2. This classification solves the first condition. In the following subsections, we are going to impose the condition $\sum q_i > 1$ for each type and list all possible solutions.

Not all the solutions in different types are distinct. An important criteria for the equivalence of two isolated hypersurface singularity is that their Jacobi algebra is isomorphic as a graded algebra [39]. Since the basis of Jacobi algebra determines the $\mathcal{N} = 2$ geometry and the spectrum on the Coulomb branch, this indicates that the Coulomb branch spectrum determines the theory which can be defined by hypersurface singularity. Since the Poincare polynomial for the Jacobi algebra of IHS with a \mathbb{C}^* action is determined only by the weights w_i and degree d , if we find the weights and degree of two different polynomials f and f' are the same, we know that they are isomorphic. In practice, one can also find simple isomorphism between f and f' if $f - f'$ are sum of weight one monomials.

One can represent the singularity by Newton polytope in R^4 . Let's assume that the singularity takes the following form

$$f = \sum a_\alpha z^\alpha \quad (3.3)$$

The lattice points of the Newton polytope are a_α with $a_\alpha \neq 0$. For the hypersurface singularity with a \mathbb{C}^* action, the points are on the hyperplane defined by the following equation

$$x_0q_0 + x_1q_1 + x_2q_2 + x_3q_3 = 1. \quad (3.4)$$

The Newton polytope is formed by the points $(a_\alpha + b)$, $a_\alpha \neq 0$, $b \in R^{4+}$. The condition $\sum q_i > 1$ implies that there are no points (n_0, n_1, n_2, n_3) outside Newton polytope such that $(n_0 + 1, n_1 + 1, n_2 + 1, n_3 + 1)$ is in the interior of Newton polytope.

Once the normal form and Milnor number of a IHS is given, one can easily compute various interesting physical quantities:

- The monomial basis of Jacobi algebra can be computed using Singular [40], and $\mathcal{N} = 2$ geometry is given by

$$F(z, \lambda) = f(z) + \sum_{i=1}^{\mu} \lambda_i \phi_i(z), \quad (3.5)$$

and one can also find the scaling dimensions of λ_i pretty easily. Once the spectrum is known, one can list the number of Coulomb branch operators, the number of mass parameters, and the number of exact marginal deformations, etc. This is helpful for the classification purpose.

- The central charge a and c can be extracted from the information of spectrum and the Milnor number.

The above computations can be made using the computer software Singular [40].

Type	$f(z_0, z_1, z_2, z_3)$	$\sum q_i$
I	$z_0^a + z_1^b + z_2^c + z_3^d$	$\frac{1}{a} + \frac{1}{b} + \frac{1}{c} + \frac{1}{d}$
II	$z_0^a + z_1^b + z_2^c + z_2 z_3^d$	$\frac{1}{a} + \frac{1}{b} + \frac{1}{c} + \frac{c-1}{cd}$
III	$z_0^a + z_1^b + z_2^c z_3 + z_2 z_3^d$	$\frac{1}{a} + \frac{1}{b} + \frac{d-1}{cd-1} + \frac{c-1}{cd-1}$
IV	$z_0^a + z_0 z_1^b + z_2^c + z_2 z_3^d$	$\frac{1}{a} + \frac{a-1}{ab} + \frac{1}{c} + \frac{c-1}{cd}$
V	$z_0^a z_1 + z_0 z_1^b + z_2^c + z_2 z_3^d$	$\frac{b-1}{ab-1} + \frac{a-1}{ab-1} + \frac{1}{c} + \frac{c-1}{cd}$
VI	$z_0^a z_1 + z_0 z_1^b + z_2^c z_3 + z_2 z_3^d$	$\frac{b-1}{ab-1} + \frac{a-1}{ab-1} + \frac{d-1}{c} + \frac{cd-1}{cd}$
VII	$z_0^a + z_1^b + z_1 z_2^c + z_2 z_3^d$	$\frac{1}{a} + \frac{1}{b} + \frac{b-1}{bc} + \frac{b(c-1)+1}{bcd}$
VIII	$z_0^a + z_1^b + z_1 z_2^c + z_1 z_3^d + z_2^p z_3^q,$ $\frac{p(b-1)}{bc} + \frac{q(b-1)}{bd} = 1$	$\frac{1}{a} + \frac{1}{b} + \frac{b-1}{bc} + \frac{b-1}{bd}$
IX	$z_0^a + z_1^b z_3 + z_2^c z_3 + z_1 z_3^d + z_1^p z_2^q,$ $\frac{p(d-1)}{bd-1} + \frac{qb(d-1)}{c(bd-1)} = 1$	$\frac{1}{a} + \frac{d-1}{bd-1} + \frac{b(d-1)}{c(bd-1)} + \frac{b-1}{bd-1}$
X	$z_0^a + z_1^b z_2 + z_2^c z_3 + z_1 z_3^d$	$\frac{1}{a} + \frac{d(c-1)+1}{bcd+1} + \frac{b(d-1)+1}{bcd+1} + \frac{c(b-1)+1}{bcd+1}$
XI	$z_0^a + z_0 z_1^b + z_1 z_2^c + z_2 z_3^d$	$\frac{1}{a} + \frac{a-1}{ab} + \frac{a(b-1)+1}{abc} + \frac{ab(c-1)+(a-1)}{abcd}$
XII	$z_0^a + z_0 z_1^b + z_0 z_2^c + z_1 z_3^d + z_1^p z_2^q$ $\frac{p(a-1)}{ab} + \frac{q(a-1)}{ac} = 1$	$\frac{1}{a} + \frac{a-1}{ab} + \frac{a-1}{ac} + \frac{a(b-1)+1}{abd}$
XIII	$z_0^a + z_0 z_1^b + z_1 z_2^c + z_1 z_3^d + z_2^p z_3^q$ $\frac{p(a(b-1)+1)}{abc} + \frac{q(a(b-1)+1)}{abd} = 1$	$\frac{1}{a} + \frac{a-1}{ab} + \frac{a-1}{ac} + \frac{a(b-1)+1}{abd}$
XIV	$z_0^a + z_0 z_1^b + z_0 z_2^c + z_0 z_3^d + z_1^p z_2^q + z_2^r z_3^s$ $\frac{p(a-1)}{ab} + \frac{q(a-1)}{ac} = 1 = \frac{r(a-1)}{ac} + \frac{s(a-1)}{ad}$	$\frac{1}{a} + \frac{a-1}{ab} + \frac{a-1}{ac} + \frac{a-1}{ad}$
XV	$z_0^a z_1 + z_0 z_1^b + z_0 z_2^c + z_2 z_3^d + z_1^p z_2^q$ $\frac{p(a-1)}{ab-1} + \frac{qb(a-1)}{c(ab-1)} = 1$	$\frac{b-1}{ab-1} + \frac{a-1}{ab-1} + \frac{b(a-1)}{c(ab-1)} + \frac{c(ab-1)-b(a-1)}{cd(ab-1)}$
XVI	$z_0^a z_1 + z_0 z_1^b + z_0 z_2^c + z_0 z_3^d + z_1^p z_2^q + z_2^r z_3^s$ $\frac{p(a-1)}{ab-1} + \frac{qb(a-1)}{c(ab-1)} = 1 = \frac{r(a-1)}{ac} + \frac{s(a-1)}{ad}$	$\frac{b-1}{ab-1} + \frac{a-1}{ab-1} + \frac{b(a-1)}{c(ab-1)} + \frac{b(a-1)}{d(ab-1)}$
XVII	$z_0^a z_1 + z_0 z_1^b + z_1 z_2^c + z_0 z_3^d + z_1^p z_2^q + z_0^r z_2^s$ $\frac{p(a-1)}{ab-1} + \frac{qb(a-1)}{d(ab-1)} = 1 = \frac{r(b-1)}{ab-1} + \frac{sa(b-1)}{c(ab-1)}$	$\frac{b-1}{ab-1} + \frac{a-1}{ab-1} + \frac{a(b-1)}{c(ab-1)} + \frac{b(a-1)}{d(ab-1)}$
XVIII	$z_0^a z_2 + z_0 z_1^b + z_1 z_2^c + z_1 z_3^d + z_2^p z_3^q$ $\frac{p(a(b-1)+1)}{abc+1} + \frac{qc[a(b-1)+1]}{d(abc+1)} = 1$	$\frac{b(c-1)+1}{abc+1} + \frac{c(a-1)+1}{abc+1} + \frac{a(b-1)+1}{c(abc+1)} + \frac{c(a(b-1)+1)}{d(abc+1)}$
XIX	$z_0^a + z_0 z_1^b + z_2^c z_1 + z_2 z_3^d$	$\frac{[b(d(c-1)+1)-1]}{abcd-1} + \frac{[d(c(a-1)+1)-1]}{abcd-1}$ $+ \frac{[a(b(d-1)+1)-1]}{abcd-1} + \frac{[c(a(b-1)+1)-1]}{abcd-1}$

Table 1. The canonical form for isolated hypersurface singularity with a good \mathbb{C}^* action whose weights on coordinates z_i are also given.

3.1 Type I

Here $f = z_0^a + z_1^b + z_2^c + z_3^d$, and $a, b, c, d \geq 2$ so that there is isolated singularity at the origin. The $\sum q_i > 1$ condition is

$$\frac{1}{a} + \frac{1}{b} + \frac{1}{c} + \frac{1}{d} > 1. \quad (3.6)$$

Type	$f(z_0, z_1, z_2, z_3)$	μ
I	$z_0^a + z_1^b + z_2^c + z_3^d$	$\mu = (a-1)(b-1)(c-1)(d-1)$
II	$z_0^a + z_1^b + z_2^c + z_2 z_3^d$	$\mu = (a-1)(b-1)[c(d-1)+1]$
III	$z_0^a + z_1^b + z_2^c z_3 + z_2 z_3^d$	$\mu = (a-1)(b-1)cd$
IV	$z_0^a + z_0 z_1^b + z_2^c + z_2 z_3^d$	$\mu = [a(b-1)+1][c(d-1)+1]$
V	$z_0^a z_1 + z_0 z_1^b + z_2^c + z_2 z_3^d$	$\mu = ab[c(d-1)+1]$
VI	$z_0^a z_1 + z_0 z_1^b + z_2^c z_3 + z_2 z_3^d$	$\mu = abcd$
VII	$z_0^a + z_1^b + z_1 z_2^c + z_2 z_3^d$	$\mu = (a-1)[bc(d-1)+b-1]$
VIII	$z_0^a + z_1^b + z_1 z_2^c + z_1 z_3^d + z_2^p z_3^q,$ $\frac{p(b-1)}{bc} + \frac{q(b-1)}{bd} = 1$	$\mu = \frac{(a-1)[b(c-1)+1][b(d-1)+1]}{b-1}$
IX	$z_0^a + z_1^b z_3 + z_2^c z_3 + z_1 z_3^d + z_1^p z_2^q,$ $\frac{p(d-1)}{bd-1} + \frac{qb(d-1)}{c(bd-1)} = 1$	$\mu = \frac{(a-1)d[c(bd-1)-b(d-1)]}{d-1}$
X	$z_0^a + z_1^b z_2 + z_2^c z_3 + z_1 z_3^d$	$\mu = (a-1)bcd$
XI	$z_0^a + z_0 z_1^b + z_1 z_2^c + z_2 z_3^d$	$\mu = abc(d-1) + a(b-1) + 1$
XII	$z_0^a + z_0 z_1^b + z_0 z_2^c + z_1 z_3^d + z_1^p z_2^q$ $\frac{p(a-1)}{ab} + \frac{q(a-1)}{ac} = 1$	$\mu = \frac{(a(c-1)+1)(ab(d-1)+a-1)}{a-1}$
XIII	$z_0^a + z_0 z_1^b + z_1 z_2^c + z_1 z_3^d + z_2^p z_3^q$ $\frac{p(a(b-1)+1)}{abc} + \frac{q(a(b-1)+1)}{abd} = 1$	$\mu = \frac{[ab(c-1)+a-1][ab(d-1)+a-1]}{a(b-1)+1}$
XIV	$z_0^a + z_0 z_1^b + z_0 z_2^c + z_0 z_3^d + z_1^p z_2^q + z_2^r z_3^s$ $\frac{p(a-1)}{ab} + \frac{q(a-1)}{ac} = 1 = \frac{r(a-1)}{ac} + \frac{s(a-1)}{ad}$	$\mu = \frac{[a(b-1)+1][a(c-1)+1][a(d-1)+1]}{(a-1)^2}$
XV	$z_0^a z_1 + z_0 z_1^b + z_0 z_2^c + z_2 z_3^d + z_1^p z_2^q$ $\frac{p(a-1)}{ab-1} + \frac{qb(a-1)}{c(ab-1)} = 1$	$\mu = \frac{a[c(d-1)(ab-1)+b(a-1)]}{a-1}$
XVI	$z_0^a z_1 + z_0 z_1^b + z_0 z_2^c + z_0 z_3^d + z_1^p z_2^q + z_2^r z_3^s$ $\frac{p(a-1)}{ab-1} + \frac{qb(a-1)}{c(ab-1)} = 1 = \frac{r(a-1)}{ac} + \frac{s(a-1)}{ad}$	$\mu = \frac{a[c(ab-1)-b(a-1)][d(ab-1)-b(a-1)]}{b(a-1)^2}$
XVII	$z_0^a z_1 + z_0 z_1^b + z_1 z_2^c + z_0 z_3^d + z_1^p z_2^q + z_0^r z_2^s$ $\frac{p(a-1)}{ab-1} + \frac{qb(a-1)}{d(ab-1)} = 1 = \frac{r(b-1)}{ab-1} + \frac{sa(b-1)}{c(ab-1)}$	$\mu = \frac{[c(ab-1)-a(b-1)][d(ab-1)-b(a-1)]}{(a-1)(b-1)}$
XVIII	$z_0^a z_2 + z_0 z_1^b + z_1 z_2^c + z_1 z_3^d + z_2^p z_3^q$ $\frac{p(a(b-1)+1)}{abc+1} + \frac{qc[a(b-1)+1]}{d(abc+1)} = 1$	$\mu = \frac{ab[abc(d-1)+c(a-1)+d]}{a(b-1)+1}$
XIX	$z_0^a + z_0 z_1^b + z_2^c z_1 + z_2 z_3^d$	$\mu = abcd$

Table 2. The Milnor number of the Hypersurface singularities.

There is an obvious symmetry exchanging (a, b, c, d) , so we can require $a \leq b \leq c \leq d$.

The solutions to inequality 3.6 are separated in seven infinite sequences which are actually already studied (we also list their names used in literature) The first four classes have been studied in [17], and they can be also engineered using M5 brane with the *ADE* type on a sphere with a single irregular singularity [10, 11]. The last three classes always have exact marginal deformations and can be described by a weakly coupled gauge theories,

Solution	Other name
$(2,2,p,q)$	(A_{p-1}, A_{q-1})
$(2,3,3,k)$	(D_4, A_{k-1})
$(2,3,4,k)$	(E_6, A_{k-1})
$(2,3,5,k)$	(E_8, A_{k-1})
$(2,3,6,k)$	$(E_8^{1,1}, A_{k-1})$
$(2,4,4,k)$	$(E_7^{1,1}, A_{k-1})$
$(3,3,3,k)$	$(E_6^{1,1}, A_{k-1})$

Table 3. Infinite sequence of type I singularity.

and some aspects of these theories are studied in [20]. There are also 13 class of sporadic examples, see table. 4.

$(2,3,7,k)$	$6 < k < 42$	$(2,3,8,k)$	$7 < k < 24$	$(2,3,9,k)$	$8 < k < 18$
$(2,3,10,k)$	$9 < k < 15$	$(2,3,11,k)$	$10 < k < 14$	$(2,4,5,k)$	$4 < k < 20$
$(2,4,6,k)$	$5 < k < 12$	$(2,4,7,k)$	$6 < k < 10$	$(2,5,5,k)$	$4 < k < 10$
$(2,5,6,k)$	$5 < k < 8$	$(3,3,4,k)$	$3 < k < 12$	$(3,3,5,k)$	$4 < k < 8$
$(3,4,4,k)$	$3 < k < 6$				

Table 4. Sporadic sequence of type I singularity.

3.2 Type II

Here $f = z_0^a + z_1^b + z_2^c + z_3^d$, and we require $a, b, c \geq 2$, $d \geq 1$ to have an isolated singularity at the origin. There are some overlap with Type I singularity. Since the weights of z_3 is $\frac{c-1}{dc}$, if we can find integer n such that $\frac{n(c-1)}{dc} = 1$, then z_3^n is an exact marginal deformation and the singularity can be put in the equivalent form $f' = z_0^a + z_1^b + z_2^c + z_3^n$, which is a type I singularity. It is easy to find out that the reducible condition is

$$\frac{d}{c-1} \in \mathbb{Z}. \quad (3.7)$$

The $\sum q_i > 1$ inequality is

$$\frac{1}{a} + \frac{1}{b} + \frac{1}{c} + \frac{c-1}{cd} > 1, \quad (3.8)$$

This equation is symmetric in exchanging (a, b) and (c, d) , so we could require $a \leq b$ and $c \leq d$ in solving the inequality. The exchange of a, b gives us equivalent singularity, while the exchange of (c, d) gives us different singularity.

We list the solutions by requiring $a \leq b$ and $c \leq d$ and one should keep in mind that exchanging c and d would give us inequivalent theory. Some of the solutions can be reduced to type I using the reduction discussed above. More generally, if we find the same spectrum from the deformations with certain type I singularity, then those two singularities give the same 4d SCFT.

(r,s,t,1)	(2,2,r,s)	(2, r, 2, s)	(3,s,2,2)	(4,s,2,2)
(2,3,3,s)	(2,3,4,s)	((2,3,5,s)	(2,3,6,s)	(2,4,3,s)
(2,5,3,s)	(2,6,3,s)	(2,s,3,3)	(2,s,3,4)	(3,3,2,s)
(3,4,2,s)	(3,5,2,s)	(3,6,2,s)	(3,s,2,3)	(2,4,4,s)
(4,4,2,s)	(3,3,3,s)			

Table 5. Infinite sequences of type II singularity.

(5,k,2,2)	$4 < k < 20$	(6,k,2,2)	$5 < k < 12$	(7,k,2,2)	$6 < k < 10$
(2,3,7,k)	$6 < k < 36$	(2,3,8,k)	$7 < k < 21$	(2,3,9,k)	$8 < k < 16$
(2,3,10,k)	$9 < k < 14$	(2,3,11,k)	$10 < k < 12$	(2,7,3,k)	$6 < k < 28$
(2,8,3,k)	$7 < k < 16$	(2,9,3,k)	$8 < k < 12$	(2, k, 3, 5)	$5 < k < 30$
(2, k, 3, 6)	$6 < k < 18$	(2, k, 3, 7)	$7 < k < 14$	(2, k, 3, 8)	$8 < k < 12$
(2, k, 3, 9)	$9 < k < 11$	(3,7,2,k)	$6 < k < 21$	(3,8,2,k)	$7 < k < 12$
(3,k,2,4)	$4 < k < 24$	(3,k,2,5)	$5 < k < 15$	(3,k,2,6)	$6 < k < 12$
(3,k,2,8)	$8 < k < 10$	(4,k,2,3)	$3 < k < 12$	(5,k,2,3)	$4 < k < 8$
(2,4,5,k)	$4 < k < 16$	(2,4,6,k)	$5 < k < 10$	(2, 4, 7, k)	$6 < k < 8$
(2,6,4,k)	$5 < k < 9$	(2,k,4,4)	$4 < k < 16$	(2,k,4,5)	$5 < k < 10$
(2,k,4,6)	$6 < k < 8$	(4,5,2,k)	$4 < k < 10$	(4,k,2,4)	$4 < k < 8$
(4,k,2,5)	$5 < k < 7$	(2,5,5, k)	$4 < k < 8$	(2,5,6,k)	$5 < k < 7$
(2,k,5,5)	$5 < k < 8$	(3,3,4,k)	$3 < k < 9$	(3,3,5,k)	$4 < k < 6$
(3,4,3,k)	$3 < k < 8$	(3,k,3,3)	$3 < k < 9$	(3,k,3,4)	$4 < k < 6$
(4,k,3,3)	$3 < k < 6$	(3,4,4,4)	(5,5,2,4)	(2,5,4,k)	$4 < k < 16$

Table 6. Sporadic sequences of type II singularity.

The infinite sequences of solutions are listed in table. 5, and the sporadic sequences are listed in table. 6.

3.3 Type III

Here $f = z_0^a + z_1^b + z_2^c z_3 + z_2 z_3^d$, and we require $a, b, c, d \geq 2$ so that there is only an isolated singularity at the origin. There is an obvious symmetry exchanging a, b , and c, d , so we require $b \geq a$ and $d \geq c$. The weights of z_2 and z_3 are

$$q(z_2) = \frac{d-1}{cd-1}, \quad q(z_3) = \frac{c-1}{cd-1} \quad (3.9)$$

If we can find an integer n such that $nq(z_2)$ or $nq(z_3) = 1$, we can reduce it to type II singularity. The solutions can be easily found, i.e

$$\frac{c-1}{d-1} \text{ or } \frac{d-1}{c-1} \in \mathbb{Z} \quad (3.10)$$

The inequality we are going to solve is

$$\frac{1}{a} + \frac{1}{b} + \frac{d-1}{cd-1} + \frac{c-1}{cd-1} > 1. \quad (3.11)$$

(2,2,r,s)	(2,r,2,s)	(3, s, 2, 2)	(2,3,3,s)	(2,3,4,s)
(2,3,5,s)	(2,3,6,s)	(2,4,3,s)	(2,5,3,s)	(2,6,3,s)
(2,s,3,3)	(3,3,2,s)	(3,4,2,s)	(3,5,2,s)	(3,6,2,s)
(2,4,4,s)	(4,4,2,s)	(3,3,3,s)		

Table 7. Infinite sequence of type III singularity.

(4,k,2,2)	$3 < k < 12$	(5,k,2,2)	$4 < k < 8$	(2,3,7,k)	$6 < k < 31$
(2,3,8,k)	$7 < k < 19$	(2,3,9,k)	$8 < k < 15$	(2,3,10,k)	$9 < k < 13$
(2,7,3,k)	$6 < k < 19$	(2,8,3,k)	$7 < k < 11$	(2,k,3,4)	$4 < k < 22$
(2,k,3,5)	$5 < k < 14$	(2,k,3,6)	$6 < k < 12$	(2,k,3,7)	$7 < k < 10$
(2,k,3,8)	$8 < k < 10$	(3,7,2,k)	$6 < k < 11$	(3,k,2,3)	$3 < k < 15$
(3,k,2,4)	$4 < k < 11$	(3,k,2,5)	$5 < k < 9$	(3,k,2,6)	$6 < k < 9$
(2,4,5,k)	$4 < k < 13$	(2,4,6,k)	$5 < k < 9$	(2,5,4,k)	$4 < k < 12$
(2,6,4,k)	$5 < k < 7$	(2,k,4,4)	$4 < k < 10$	(2,k,4,5)	$5 < k < 8$
(2,5,5,k)	$4 < k < 7$	(3,3,4,k)	$3 < k < 7$	(3,4,3,k)	$3 < k < 6$
(3,k,3,3)	$3 < k < 6$	(4,5,2,5)	(4,5,2,4)		

Table 8. Finite sequence of type III singularity.

The infinite sequences of solutions are listed in table . 7, and the sporadic sequences are listed in table . 8 Here again we list the possible theories and it is easy to identify them with some of type II theories.

3.4 Type IV

Here $f = z_0^a + z_0 z_1^b + z_2^c + z_2 z_3^d$, and we have $a, c \geq 2$ and $b, d \geq 1$ so that there is an isolated singularity at the origin. There is an symmetry exchanging the pair (a, b) and (c, d) , so we also require $d \geq b$. Again his can be reduced to the first two types if

$$\frac{b-1}{a} \in \mathbb{Z} \quad \text{or} \quad \frac{d-1}{c} \in \mathbb{Z} \quad (3.12)$$

The inequality we want to solve is

$$\frac{1}{a} + \frac{a-1}{ab} + \frac{1}{c} + \frac{c-1}{cd} > 1, \quad (3.13)$$

For this inequality, there is an symmetry exchanging (a, b) and (c, d) , so we require $b \geq a$ and $d \geq c$ for the solutions. One should keep in mind that the exchange of (a, b) or (c, d) give us inequivalent singularity! The infinite sequence of solutions are listed in table .9, and the sporadic sequence of solutions are listed in table . 10.

(r,1,s,t)	(r,1,s,1)	(2, 2, 2, s)	(2,2,3,s)	(2,2,4,s)
(2,r,2,s)	(2,3,3,s)	(2,s,3,3)	(2,s,3,4)	

Table 9. Infinite sequence of type IV singularity.

(2,2,5,k)	$4 < k < 16$	(2,2,6,k)	$5 < k < 10$	(2,2,7,k)	$6 < k < 8$
(2,3,4,k)	$3 < k < 9$	(2,3,5,k)	$4 < k < 6$	(2,4,3,k)	$3 < k < 16$
(2,5,3,k)	$5 < k < 15$	(2,6,3,k)	$6 < k < 9$	(2,4,4,k)	$3 < k < 7$
(2,k,4,4)	$4 < k < 8$	(3,3,3,k)	$2 < k < 6$		

Table 10. Sporadic sequence of type IV singularity.

3.5 Type V

The polynomial is $f = z_0^a z_1 + z_0 z_1^b + z_2^c + z_2 z_3^d$, we have $a, b, c \geq 2$, $d \geq 1$ so that there is an isolated singularity at the origin. There is a symmetry exchanging the pair (a, b) . The singularity is reduced to previous type if

$$\frac{b-1}{a-1} \in \mathbb{Z} \text{ or } \frac{d}{c-1} \in \mathbb{Z} \quad (3.14)$$

The inequality we want to solve is

$$\frac{b-1}{ab-1} + \frac{a-1}{ab-1} + \frac{1}{c} + \frac{c-1}{cd} > 1, \quad (3.15)$$

and this inequality is invariant under exchange of c and d , so the solution is listed by requiring $d \geq c$, however the singularity associated with these two different ordering are different! The infinite sequence of solutions are listed in table. 11, and the sporadic sequence of solutions are listed in table. 12.

(r,s,t,1)	(2,2,2,s)	((2,2,3,s)	(2,r,2,s)	(3,s,2,2)
(4,s,2,2)	(2,s,3,3)	(2,s,3,4)	(3,3,2,s)	(3,s,2,3)

Table 11. Infinite sequence of type V singularity.

(2,2,4,k)	$3 < k < 9$	(2,2,5,k)	$4 < k < 6$	(5,k,2,2)	$4 < k < 13$
(5,k,2,2)	$4 < k < 13$	(6,k,2,2)	$5 < k < 9$	(2,3,3,k)	$2 < k < 10$
(2,3,4,4)	$3 < k < 5$	(2,4,3,k)	$3 < k < 7$	(2,5,3,k)	$4 < k < 6$
(2,k,3,5)	$5 < k < 8$	(3,4,2,k)	$4 < k < 11$	(3,5,2,k)	$5 < k < 8$
(4,k,2,3)	$3 < k < 7$	(2,4,4,4)	(4,4,2,4)	(3,3,3,3)	(3,4,3,3)

Table 12. Sporadic sequence of type V singularity.

3.6 Type VI

The polynomial is $f = z_0^a z_1 + z_0 z_1^b + z_2^c z_3 + z_2 z_3^d$, we have $a, b, c, d \geq 2$ so that there is an isolated singularity at the origin. Due to symmetry, we require $b \geq a$, $d \geq c$, and $c \geq a$. The singularity is reduced to previous type if

$$\frac{b-1}{a-1} \in \mathbb{Z} \text{ or } \frac{d-1}{c-1} \in \mathbb{Z}. \quad (3.16)$$

The inequality we want to solve is

$$\frac{b-1}{ab-1} + \frac{a-1}{ab-1} + \frac{d-1}{c} + \frac{cd-1}{cd} > 1 \quad (3.17)$$

The infinite sequence of solutions are listed in table. 13. All of them can be reduced to previous type, so there is no new infinite sequence of solutions. The sporadic set of examples are listed in table. 14, and all of them can also be reduced to previous type of singularities. Therefore there is no new solutions for this class of singularity.

(2,2,2,s)	(2,2,3,s)	(2,r,2,s)	(2,s,3,3)
-----------	-----------	-----------	-----------

Table 13. Infinite sequence of type VI singularity.

(2,2,4,k)	$3 < k < 7$	(2,3,3,k)	$2 < k < 7$	(2,4,3,4)	(2,5,3,4)
-----------	-------------	-----------	-------------	-----------	-----------

Table 14. Sporadic sequence of type VI singularity.

3.7 Type VII

The singularity has the form $f = z_0^a + z_1^b + z_1 z_2^c + z_2 z_3^d$. We have $a \geq 2, b \geq 2, c \geq 1, d \geq 1$ so that there is an isolated singularity at the origin. The singularity can be reduced to previous type if

$$\frac{c}{b-1} \in \mathbb{Z}, \quad \text{or} \quad \frac{d(b-1)}{b(c-1)+1} \in \mathbb{Z} \quad (3.18)$$

The inequality we want to solve is

$$\frac{1}{a} + \frac{1}{b} + \frac{b-1}{bc} + \frac{b(c-1)+1}{bcd} > 1. \quad (3.19)$$

This inequality is invariant under exchange of (b, d) , so the solution is listed by requiring $d \geq b$. However, two orderings give different solutions. The infinite sequence of solutions are listed in table. 15, and the sporadic examples are listed in table. 16.

(r,s,1,t)	(r,s,t,1)	(2,r,2,s)	(2,2,r,s)	(3,2,2,s)
(4,2,2,s)	(s,2,2,2)	(s,2,2,3)	(r,2,s,2)	(2,3,3,s)
(2,4,3,s)	(3,3,2,s)	(2,3,4,s)	(2,3,s,3)	(2,3,s,4)
(2,3,s,5)	(2,3,s,6)	(3,2,3,s)	(3,2,s,3)	(3,2,s,4)
(3,2,s,5)	(3,2,s,6)	(4,2,s,3)	(5,2,s,3)	(6,2,s,3)
(2,4,s,4)	(4,2,s,4)	(3,3,s,3)		

Table 15. Infinite sequence of type VII singularity.

(5,2,2,k)	$4 < k < 15$	(6,2,2,k)	$5 < k < 9$	(k,2,2,4)	$4 < k < 16$
(k,2,2,5)	$5 < k < 10$	(k,2,2,6)	$6 < k < 8$	(2,5,3,k)	$4 < k < 22$
(2,6,3,k)	$5 < k < 13$	(2,7,3,k)	$6 < k < 10$	(2,8,3,k)	$7 < k < 9$
(3,4,2,k)	$3 < k < 15$	(3,5,2,k)	$4 < k < 9$	(3,6,2,k)	$5 < k < 7$
(2,3,5,k)	$4 < k < 26$	(2,3,6,k)	$5 < k < 16$	(2,3,7,k)	$6 < k < 13$
(2,3,8,k)	$7 < k < 11$	(2,3,9,k)	$8 < k < 10$	(4,3,2,k)	$3 < k < 8$
(2,3,k,7)	$7 < k < 24$	(2,3,k,8)	$8 < k < 14$	(2,3,k,9)	$1 < k < 11$
(k,3,2,3)	$3 < k < 9$	(k,3,2,4)	$4 < k < 6$	(3,2,4,k)	$3 < k < 21$
(3,2,5,k)	$4 < k < 14$	(3,2,6,k)	$5 < k < 11$	(3,2,7,k)	$6 < k < 10$
(3,2,8,k)	$7 < k < 9$	(4,2,3,k)	$3 < k < 10$	(5,2,3,k)	$4 < k < 7$
(3,2,k,7)	$7 < k < 18$	(3,2,k,8)	$8 < k < 11$	(k,2,3,3)	$3 < k < 18$
(k,2,3,4)	$4 < k < 8$	(7,2,k,3)	$6 < k < 14$	(k,2, 4,3)	$4 < k < 12$
(k,2,5,3)	$5 < k < 10$	(k,2,6,3)	$6 < k < 9$	(k,2,7,3)	$7 < k < 9$
(2,4,4,k)	$3 < k < 13$	(2,5,4,k)	$4 < k < 8$	(2,6,4,k)	$5 < k < 7$
(4,4,2,4)		(2,4,5,k)	$4 < k < 9$	(2,4,6,k)	$5 < k < 7$
(2,4,k,5)	$5 < k < 12$	(2,4,k,6)	$6 < k < 8$	(4,2,4,k)	$3 < k < 7$
(4,2,5,k)	$4 < k < 6$	(4,2,k,5)	$5 < k < 8$	(k,2,4,4)	$4 < k < 7$
(5,2,k,4)	$4 < k < 8$	(2,5,5,5)		(2,5,6,5)	
(3,3,3,k)	$2 < k < 7$	(3,4,3,4)		(3,3,4,4)	
(3,3,5,4)		(k,3,3,3)	$3 < k < 6$	(4,3,k,3)	$3 < k < 6$

Table 16. Sporadic sequence for type VII singularity.

3.8 Type VIII

The singularity has the form $f = z_0^a + z_1^b + z_1 z_2^c + z_1 z_3^d + z_2^p z_3^q$ with constraint $\frac{p(b-1)}{bc} + \frac{q(b-1)}{bd} = 1$. We require $a, b \geq 2$, and $c, d \geq 1$ such that there is an isolated singularity at the origin. The singularity is reduced to previous class if

$$\frac{c}{b-1} \in \mathbb{Z}, \quad \text{or}, \quad \frac{d}{b-1} \in \mathbb{Z} \quad (3.20)$$

Here c and d are totally symmetric, and we assume $d \geq c$. Notice that it is not always possible to find a pair of integer (p, q) for a given set of integers (a, b, c, d) .

The inequality we want to solve is:

$$\frac{1}{a} + \frac{1}{b} + \frac{b-1}{bc} + \frac{b-1}{bd} > 1, \quad (3.21)$$

The infinite sequence of solutions are listed in table. 17, and the sporadic examples are listed in table. 18

(r,s,1,t)	(r,s,t,1)	(2,2,r,s)	(3,2,2,s)	(4,2,2,s)
(2,r,2,s)	(s,2,2,2)	(r,s,2,2)	(2,3,3,s)	(2,3,4,s)
(3,2,3,s)	(2,4,3,s)	(2,s,3,3)	(2,s,3,4)	(2,s,3,5)
(2,s,3,6)	(3,3,2,s)	(3,s,2,3)	(3,s,2,4)	(3,s,2,5)
(3,s,2,6)	(4,s,2,3)	(5,s,2,3)	(6,s,2,3)	(2,s,4,4)
(4,s,2,4)	(3,s,3,3)			

Table 17. Infinite sequence of type VIII singularity.

(5,2,2,k)	$5 < k < 12$	(k,2,2,3)	$3 < k < 12$	(k,2,2,4)	$4 < k < 8$
(k,2,2,5)	$5 < k < 7$	(2,3,5,k)	$4 < k < 20$	(2,3,6,k)	$5 < k < 12$
(2,3,7,k)	$6 < k < 10$	(3,2,4,k)	$3 < k < 12$	(3,2,5,k)	$4 < k < 8$
(2,5,3,k)	$4 < k < 24$	(2,6,3,k)	$5 < k < 15$	(2,7,3,k)	$6 < k < 12$
(2,8,3,k)	$7 < k < 11$	(2,9,3,k)	$8 < k < 10$	(4,2,3,k)	$3 < k < 6$
(2,k,3,7)	$7 < k < 22$	(2,k,3,8)	$8 < k < 13$	(k,2,3,3)	$3 < k < 6$
(3,4,2,k)	$3 < k < 18$	(3,5,2,k)	$4 < k < 12$	(3,6,2,k)	$5 < k < 10$
(3,7,2,k)	$6 < k < 9$	(3,8,2,k)	$7 < k < 9$	(4,3,2,k)	$3 < k < 8$
(3,k,2,7)	$7 < k < 15$	(k,3,2,3)	$3 < k < 9$	(k,3,2,4)	$4 < k < 6$
(k,4,2,3)	$4 < k < 8$	(k,5,2,3)	$5 < k < 8$	(k,6,2,3)	$6 < k < 8$
(2,4,4,k)	$3 < k < 12$	(2,4,5,k)	$4 < k < 8$	(2,5,4,k)	$4 < k < 8$
(2,6,4,k)	$5 < k < 7$	(2,k,4,5)	$5 < k < 11$	(4,4,2,k)	$3 < k < 6$
(4,5,2,k)	$4 < k < 6$	(5,4,2,4)	(2,5,5,5)	(3,3,3,k)	$2 < k < 6$
(3,4,3,4)	(4,3,3,3)				

Table 18. Sporadic sequence of type VIII singularity.

3.9 Type IX

The singularity is $f = z_0^a + z_1^b z_3 + z_2^c z_3 + z_1 z_3^d + z_2^p z_3^q$, with constraint $\frac{p(d-1)}{bd-1} + \frac{qb(d-1)}{c(bd-1)} = 1$. To have an isolated singularity at the origin, we need $a, b, d \geq 2, c \geq 1$. The simple reduction condition is that

$$\frac{b-1}{d-1} \in \mathbb{Z}, \quad \frac{d-1}{b-1} \in \mathbb{Z}, \quad \frac{c(b-1)}{b(d-1)} \in \mathbb{Z} \quad (3.22)$$

The inequality we want to solve is

$$\frac{1}{a} + \frac{d-1}{bd-1} + \frac{b(d-1)}{c(bd-1)} + \frac{b-1}{bd-1} > 1, \quad (3.23)$$

The infinite sequences of solutions (before imposing the constraint) are listed in table. 19, and the sporadic solutions are listed in table. 20.

(r,s,1,t)	(2,2,r,s)	(2,r,2,s)	(r,2,2,s)	(3,2,s,2)
(3,s,2,2)	(4,s,2,2)	(2,3,3,s)	(2,3,,4,s)	(2,3,5,s)
(2,3,6,s)	(2,3,s,3)	(3,2,3,s)	(3,2,4,s)	(3,2,5,s)
(3,2,6,s)	(2,4,3,s)	(2,5,3,s)	(2,6,3,s)	(4,2,3,s)
(5,2,3,s)	(6,2,3,s)	(2,s,3,3)	(2,s,3,4)	(2,s,4,3)
(3,3,2,s)	(3,4,2,s)	(3,5,2,s)	(3,6,2,s)	(4,3,2,s)
(5,3,2,s)	(6,3,2,s)	(3,s,2,3)	(3,s,3,2)	(2,4,4,s)
(4,2,4,s)	(4,4,2,s)	(3,3,3,s)		

Table 19. Infinite sequence of type IX singularity.

(k,2,3,2)	$3 < k < 9$	(k,2,4,2)	$4 < k < 6$	(5,k,2,2)	$4 < k < 8$
(k,3,2,2)	$3 < k < 10$	(k,4,2,2)	$4 < k < 7$	(2,3,7,k)	$6 < k < 15$
(2,3,8,k)	$7 < k < 9$	(2,3,k,4)	$4 < k < 18$	(2,3,k,5)	$5 < k < 12$
(2,3,k,6)	$6 < k < 10$	(2,3,k,7)	$7 < k < 9$	(3,2,7,k)	$6 < k < 8$
(3,2,k,3)	$3 < k < 12$	(3,2,k,4)	$4 < k < 9$	(3,2,k,5)	$5 < k < 8$
(3,2,k,6)	$6 < k < 8$	(2,7,3,k)	$6 < k < 19$	(2,8,3,k)	$7 < k < 12$
(2,4,k,3)	$3 < k < 16$	(2,5,k,3)	$4 < k < 10$	(2,6,k,3)	$5 < k < 8$
(4,2,k,3)	$3 < k < 6$	(2,k,3,5)	$5 < k < 21$	(2,k,3,6)	$6 < k < 14$
(2,k,3,7)	$7 < k < 11$	(2,k,3,8)	$8 < k < 10$	(2,k,5,3)	$5 < k < 15$
(2,k,6,3)	$6 < k < 9$	(k,2,3,3)	$3 < k < 8$	(k,2,3,4)	$4 < k < 7$
(k,2,3,5)	$5 < k < 7$	(3,7,2,k)	$6 < k < 13$	(3,3,k,2)	$2 < k < 9$
(3,4,k,2)	$3 < k < 6$	(3,k,2,4)	$4 < k < 16$	(3,k,2,5)	$5 < k < 11$
(3,k,2,6)	$6 < k < 10$	(3,k,2,7)	$7 < k < 9$	(3,k,4,2)	$4 < k < 8$
(k,3,2,3)	$3 < k < 8$	(k,3,2,4)	$4 < k < 8$	(k,3,2,5)	$5 < k < 7$
(4,3,3,2)	(4,4,3,2)	(5,4,2,3)	(2,5,5,4)	(4,k,2,3)	$3 < k < 7$
(2,4,5,k)	$4 < k < 9$	(2,4,k,4)	$4 < k < 8$	(2,4,k,5)	$5 < k < 7$
(2,5,4,k)	$4 < k < 9$	(2,k,4,4)	$4 < k < 10$	(2,k,4,5)	$5 < k < 7$
(2,6,5,4)	(4,5,2,4)	(3,3,4,3)	(3,4,3,3)		

Table 20. Sporadic sequence of type IX singularity.

3.10 Type X

The singularity is $f = z_0^a + z_1^b z_2 + z_2^c z_3 + z_1 z_3^d$. We require $a \geq 2$ and $b, c, d \geq 2$ so that there is an isolated singularity at the origin. The singularity is reduced to previous type if

$$\frac{b(d-1)+1}{d(c-1)+1} \in \mathbb{Z}, \quad \text{or} \quad \frac{c(b-1)+1}{b(d-1)+1} \in \mathbb{Z} \quad \text{or} \quad \frac{d(c-1)+1}{c(b-1)+1} \in \mathbb{Z}. \quad (3.24)$$

The inequality we would like to solve is:

$$\frac{1}{a} + \frac{d(c-1)+1}{bcd+1} + \frac{b(d-1)+1}{bcd+1} + \frac{c(b-1)+1}{bcd+1} > 1. \quad (3.25)$$

There is a symmetry in exchanging (b, c, d) so we only label the solution with $b \leq c \leq d$. Notice that there are two inequivalent singularity labeled by (b, c, d) and (b, d, c) though (if two triples are related by cyclic permutation, then they define the same singularity). The infinite sequence of solutions are listed in table. 21, and the sporadic sequence of solutions are listed in table. 22.

(r,1,s,t)	(2,2,r,s)	(3,2,2,s)	(4,2,2,s)	(s,2,2,2)
(2,3,3,s)	(2,3,4,s)	(2,3,s,4)	(3,2,3,s)	(3,2,s,3)

Table 21. Infinite sequence of type X singularity

(5,2,2,k)	$4 < k < 11$	(6,2,2,k)	$5 < k < 7$	(k,2,2,3)	$3 < k < 13$
(k,2,2,4)	$4 < k < 9$	(k,2,2,5)	$5 < k < 7$	(2,3,5,k)	$4 < k < 19$
(2,3,6,k)	$5 < k < 12$	(2,3,7,k)	$6 < k < 9$	(2,3,k,5)	$5 < k < 19$
(2,3,k,6)	$6 < k < 12$	(2,3,k,7)	$7 < k < 9$	(3,2,4,k)	$3 < k < 13$
(3,2,5,k)	$4 < k < 8$	(3,2,6,k)	$5 < k < 7$	(3,2,k,4)	$4 < k < 13$
(3,2,k,5)	$5 < k < 8$	(4,2,3,k)	$3 < k < 7$	(4,2,k,3)	$3 < k < 7$
(k,2,3,3)	$3 < k < 7$	(2,4,4,k)	$3 < k < 11$	(2,4,5,k)	$4 < k < 7$
(2,4,6,5)	(4,2,4,4)	(3,3,3,k)	$2 < k < 6$		

Table 22. Sporadic sequence of type X singularity

3.11 Type XI

The singularity is $f = z_0^a + z_0 z_1^b + z_1 z_2^c + z_2 z_3^d$. We require $a \geq 2, b, c, d \geq 1$ so that there is an isolated singularity at the origin. The singularity is reduced to previous type if

$$\frac{b}{(a-1)} \in \mathbb{Z} \text{ or } \frac{c(a-1)}{a(b-1)+1} \in \mathbb{Z}, \quad \frac{d(a(b-1)+1)}{ab(c-1)+(a-1)} \in \mathbb{Z}. \quad (3.26)$$

The inequality we want to solve is

$$\frac{1}{a} + \frac{a-1}{ab} + \frac{a(b-1)+1}{abc} + \frac{ab(c-1)+(a-1)}{abcd} > 1 \quad (3.27)$$

The infinite sequence of solutions are listed in table. 23, and the sporadic sequence of solutions are listed in table. 24.

(r,1,s,t)	(r,s,1,t)	(r,s,t,1)	(2,2,2,s)	(2,2,3,s)
(2,2,s,2)	(2,2,s,3)	(2,2,s,4)	(2,r,2,s)	(3,2,2,s)
(r,2,s,2)	(s,2,2,2)	(s,2,2,3)	(3,s,2,2)	(4,s,2,2)
(s,3,2,2)	(2,3,s,3)	(3,2,s,3)	(2,s,3,3)	(2,s,3,4)
(2,s,4,3)	(3,3,s,2)	(3,4,s,2)	(4,3,s,2)	(3,s,2,3)
(3,s,3,2)				

Table 23. Infinite sequence of type XI singularity.

(2,2,4,k)	$3 < k < 13$	(2,2,5,k)	$4 < k < 9$	(2,2,6,k)	$5 < k < 7$
(2,2,k,5)	$5 < k < 12$	(2,2,k,6)	$6 < k < 8$	(4,2,2,k)	$3 < k < 11$
(5,2,2,k)	$4 < k < 7$	(k,2,2,4)	$4 < k < 11$	(k,2,2,5)	$5 < k < 7$
(5,k,2,2)	$4 < k < 12$	(6,k,2,2)	$5 < k < 8$	(k,4,2,2)	$4 < k < 13$
(k,5,2,2)	$5 < k < 9$	(2,3,3,k)	$2 < k < 13$	(2,3,4,k)	$3 < k < 7$
(2,3,k,4)	$4 < k < 8$	(3,2,3,k)	$2 < k < 7$	(3,2,4,k)	$3 < k < 5$
(3,2,k,4)	$4 < k < 6$	(2,4,3,k)	$3 < k < 9$	(2,5,3,k)	$4 < k < 7$
(2,6,3,k)	$5 < k < 7$	(2,4,k,3)	$3 < k < 13$	(2,5,k,3)	$4 < k < 9$
(2,6,k,3)	$5 < k < 8$	(4,2,3,4)	(5,2,5,3)	(4,2,k,3)	$3 < k < 10$
(2,k,3,5)	$5 < k < 11$	(2,k,5,3)	$5 < k < 13$	(2,k,6,3)	$6 < k < 8$
(k,2,3,3)	$3 < k < 11$	(k,2,4,3)	$4 < k < 7$	(3,3,2,k)	$2 < k < 11$
(3,4,2,k)	$3 < k < 7$	(3,5,2,k)	$4 < k < 6$	(3,5,k,2)	$4 < k < 13$
(3,6,k,2)	$5 < k < 8$	(4,3,2,4)	(6,3,6,2)	(5,3,k,2)	$4 < k < 11$
(3,k,2,4)	$4 < k < 10$	(3,k,4,2)	$4 < k < 14$	(3,k,5,2)	$5 < k < 9$
(3,k,6,2)	$6 < k < 8$	(k,3,2,3)	$3 < k < 7$	(k,3,3,2)	$3 < k < 13$
(k,3,4,2)	$4 < k < 9$	(k,3,5,2)	$5 < k < 7$	(4,k,2,3)	$3 < k < 6$
(4,k,3,2)	$3 < k < 8$	(k,4,3,2)	$4 < k < 7$	(2,4,4,4)	(2,4,5,4)
(2,k,4,4)	$4 < k < 7$	(4,4,k,2)	$3 < k < 7$	(4,5,4,2)	(3,3,3,3)
(3,3,4,3)	(3,4,3,3)				

Table 24. Sporadic sequence of type XI singularity.

3.12 Type XII

Here $f = z_0^a + z_0 z_1^b + z_0 z_2^c + z_1 z_3^d + z_1^p z_2^q$ with constraint $\frac{p(a-1)}{ab} + \frac{q(a-1)}{ac} = 1$. The inequality we want to solve is

$$\frac{1}{a} + \frac{a-1}{ab} + \frac{a-1}{ac} + \frac{a(b-1)+1}{abd} > 1 \quad (3.28)$$

The infinite sequence of solutions are listed in table. 25, while the sporadic solutions are listed in table. 26.

(r,1,s,t)	(r,s,1,t)	(r,s,t,1)	(2,2,2,s)	(2,2,s,2)
(2,2,s,2)	(2,2,s,3)	(2,r,s,2)	(r,2,2,s)	(3,2,s,2)
(2,s,2,2)	(2,s,2,3)	(2,s,2,4)	(s,2,3,2)	(s,2,4,2)
(r,s,2,2)	(2,s,3,3)	(s,2,3,3)	(3,s,2,3)	(3,s,3,2)
(3,s,4,2)	(s,3,2,3)	(s,3,2,4)	(s,3,3,2)	(4,s,3,2)
(s,3,3,2)	(4,s,3,2)	(s,4,2,3)		

Table 25. Infinite sequence of type XII singularity

(2,2,3,k)	$2 < k < 9$	(2,2,4,k)	$3 < k < 6$	(2,2,k,4)	$4 < k < 8$
(2,3,2,k)	$2 < k < 10$	(2,4,2,k)	$3 < k < 7$	(2,5,2,k)	$4 < k < 6$
(4,2,k,2)	$3 < k < 12$	(5,2,k,2)	$4 < k < 8$	(6,2,k,2)	$5 < k < 7$
(2,k,2,5)	$5 < k < 8$	(k,2,5,2)	$5 < k < 11$	(2,3,3,k)	$2 < k < 5$
(2,3,k,3)	$3 < k < 9$	(3,2,3,k)	$2 < k < 6$	(3,2,k,3)	$3 < k < 6$
(2,4,k,3)	$3 < k < 6$	(2,k,3,3)	$4 < k < 8$	(k,2,3,4)	$4 < k < 7$
(3,3,2,k)	$2 < k < 7$	(3,4,2,k)	$3 < k < 5$	(3,3,k,2)	$2 < k < 12$
(3,4,k,2)	$3 < k < 8$	(3,5,k,2)	$4 < k < 7$	(4,3,2,k)	$3 < k < 6$
(5,3,2,k)	$4 < k < 6$	(4,3,k,2)	$3 < k < 6$	(3,k,2,4)	$3 < k < 6$
(3,k,5,2)	$5 < k < 10$	(k,3,2,5)	$5 < k < 7$	(k,3,4,2)	$4 < k < 7$
(4,k,2,3)	$3 < k < 12$	(5,k,2,3)	$4 < k < 8$	(6,k,2,3)	$5 < k < 7$
(5,k,3,2)	$4 < k < 12$	(6,k,3,2)	$5 < k < 8$	(k,5,2,3)	$5 < k < 9$
(4,4,2,4)	(4,4,4,2)	(4,5,4,2)	(3,3,3,3)		

Table 26. Sporadic sequence of type XII singularity

3.13 Type XIII

Here $f = z_0^a + z_0 z_1^b + z_1 z_2^c + z_1 z_3^d + z_2^p z_3^q$ with constraint $\frac{p(a(b-1)+1)}{abc} + \frac{q(a(b-1)+1)}{abd} = 1$. The inequality we want to solve is

$$\frac{1}{a} + \frac{a-1}{ab} + \frac{a-1}{ac} + \frac{a(b-1)+1}{abd} > 1. \quad (3.29)$$

The infinite sequence of solutions are listed in table. 27, while the finite sequence of solutions are listed in table. 28.

(r,1,s,t)	(r,s,1,t)	(r,s,t,1)	(2,2,2,s)	(2,2,3,s)
(2,r,2,s)	(3,2,2,s)	(s,2,2,2)	(r,s,2,2)	(2,s,3,3)
(2,s,3,4)	(2,s,3,5)	(2,s,3,6)	(3,s,2,3)	(3,s,2,4)
(3,s,2,5)	(3,s,2,6)	(4,s,2,3)	(5,s,2,3)	(6,s,2,3)
(2,s,4,4)	(4,s,2,4)	(3,s,3,3)		

Table 27. Infinite sequence of type XIII singularity.

(2,2,4,k)	$3 < k < 12$	(2,2,5,k)	$4 < k < 8$	(4,2,2,k)	$3 < k < 10$
(5,2,2,k)	$4 < k < 8$	(k,2,2,3)	$3 < k < 11$	(k,2,2,4)	$4 < k < 7$
(2,3,3,k)	$2 < k < 15$	(2,3,4,k)	$3 < k < 7$	(3,2,3,k)	$2 < k < 6$
(2,4,3,k)	$3 < k < 11$	(2,5,3,k)	$4 < k < 9$	(2,6,3,k)	$5 < k < 9$
(2,7,3,k)	$6 < k < 8$	(4,2,3,3)	(2,5,4,5)	(3,3,2,k)	$2 < k < 14$
(3,4,2,k)	$3 < k < 10$	(3,5,2,k)	$4 < k < 9$	(3,6,2,k)	$5 < k < 8$
(3,7,2,k)	$6 < k < 8$	(4,3,2,k)	$3 < k < 6$	(3,k,2,7)	$7 < k < 10$
(k,3,2,3)	$3 < k < 9$	(k,3,2,4)	$4 < k < 6$	(k,4,2,3)	$4 < k < 8$
(k,5,2,3)	$5 < k < 8$	(2,4,4,k)	$3 < k < 6$	(4,4,2,k)	$3 < k < 6$
(3,3,3,k)	$2 < k < 5$				

Table 28. Sporadic sequence of type XIII singularity.

3.14 Type XIV

Here $f = z_0^a + z_0 z_1^b + z_0 z_2^c + z_0 z_3^d + z_1^p z_2^q + z_2^r z_3^s$ with constraint $\frac{p(a-1)}{ab} + \frac{q(a-1)}{ac} = 1 = \frac{r(a-1)}{ac} + \frac{s(a-1)}{ad}$. The inequality we want to solve is

$$\frac{1}{a} + \frac{a-1}{ab} + \frac{a-1}{ac} + \frac{a-1}{ad} > 1. \quad (3.30)$$

The infinite sequence of solutions are listed in table. 29, while the sporadic ones are listed in table. 30.

(r,1,s,t)	(r,s,1,t)	(r,s,t,1)	(2,2,2,s)	(r,2,2,s)
(s,2,3,3)	(s,2,3,4)	(s,2,3,5)		

Table 29. Infinite sequence of type XIV singularity.

(3,2,3,k)	$2 < k < 6$	(4,2,3,k)	$3 < k < 6$	(5,2,3,k)	$4 < k < 6$
-----------	-------------	-----------	-------------	-----------	-------------

Table 30. Sporadic sequence of type XIV singularity.

3.15 Type XV

Here $f = z_0^a z_1 + z_0 z_1^b + z_0 z_2^c + z_2 z_3^d + z_1^p z_2^q$ with the constraint $\frac{p(a-1)}{ab-1} + \frac{qb(a-1)}{c(ab-1)} = 1$. The inequality we want to solve is

$$\frac{b-1}{ab-1} + \frac{a-1}{ab-1} + \frac{b(a-1)}{c(ab-1)} + \frac{c(ab-1) - b(a-1)}{cd(ab-1)} > 1. \quad (3.31)$$

The infinite sequence of solutions are listed in table. 31, and the sporadic sequence of solutions are listed in table. 32. There are following sporadic solutions

(r,s,1,t)	(r,s,t,1)	(2,2,2,s)	(2,2,s,2)	(2,2,s,3)
(2,r,s,2)	(r,2,2,s)	(2,s,2,2)	(2,s,2,3)	(3,s,2,2)
(s,3,2,2)	(s,3,2,2)	(s,4,2,2)	(s,2,3,3)	(s,2,3,4)
(s,2,4,3)	(3,3,s,2)	(s,3,2,3)	(s,3,3,2)	

Table 31. Infinite sequence of type XV singularity.

(2,2,3,k)	$2 < k < 7$	(2,2,4,k)	$3 < k < 5$	(2,2,k,4)	$4 < k < 6$
(2,3,2,k)	$2 < k < 7$	(2,4,2,k)	$3 < k < 5$	(2,k,2,4)	$4 < k < 6$
(4,k,2,2)	$3 < k < 10$	(5,k,2,2)	$4 < k < 7$	(k,5,2,2)	$5 < k < 9$
(2,3,k,3)	$3 < k < 6$	(3,2,3,k)	$2 < k < 6$	(3,2,k,3)	$3 < k < 8$
(4,2,k,3)	$3 < k < 6$	(5,2,k,3)	$4 < k < 6$	(2,k,3,3)	$3 < k < 6$
(3,3,2,k)	$2 < k < 5$	(3,4,k,2)	$3 < k < 8$	(4,3,k,2)	$3 < k < 9$
(5,3,k,2)	$4 < k < 6$	(3,k,3,2)	$3 < k < 9$	(3,k,4,2)	$4 < k < 6$
(k,3,4,2)	$4 < k < 9$	(2,3,3,3)	(4,2,3,4)	(4,3,2,4)	(3,4,2,3)
(4,4,3,2)	(5,4,3,2)				

Table 32. Sporadic sequence of type XV singularity.

3.16 Type XVI

Here $f = z_0^a z_1 + z_0 z_1^b + z_0 z_2^c + z_0 z_3^d + z_1^p z_2^q + z_2^r z_3^s$ with the constraint $\frac{p(a-1)}{ab-1} + \frac{qb(a-1)}{c(ab-1)} = 1 = \frac{r(a-1)}{ac} + \frac{s(a-1)}{ad}$. The inequality we want to solve is

$$\frac{b-1}{ab-1} + \frac{a-1}{ab-1} + \frac{b(a-1)}{c(ab-1)} + \frac{b(a-1)}{d(ab-1)} > 1; \quad (3.32)$$

The infinite sequence of solutions are listed in table. 33, and the finite sequence of solutions are listed in table. 34.

(r,s,1,t)	(r,s,t,1)	(2,2,2,s)	(r,2,2,s)	(2,s,2,2)
(r,s,2,2)	(s,2,3,3)	(s,2,3,4)	(s,2,3,5)	(s,3,2,3)
(s,3,2,4)	(s,3,2,5)	(s,4,2,3)	(s,5,2,3)	

Table 33. Infinite sequence of type XVI singularity.

(2,2,3,k)	$2 < k < 6$	(2,3,2,k)	$2 < k < 6$	(2,k,2,3)	$3 < k < 6$
(3,2,3,k)	$3 < k < 6$	(4,2,3,k)	$3 < k < 6$	(5,2,3,k)	$4 < k < 6$
(3,3,2,k)	$2 < k < 6$	(4,3,2,k)	$3 < k < 6$	(5,3,2,k)	$4 < k < 6$
(3,k,2,3)	$3 < k < 6$	(4,k,2,3)	$3 < k < 6$	(5,k,2,3)	$4 < k < 6$

Table 34. Sporadic sequence of type XVI singularity.

3.17 Type XVII

Here $f = z_0^a z_1 + z_0 z_1^b + z_1 z_2^c + z_0 z_3^d + z_1^p z_2^q + z_0^r z_3^s$ with the constraint $\frac{p(a-1)}{ab-1} + \frac{qb(a-1)}{d(ab-1)} = 1 = \frac{r(b-1)}{ab-1} + \frac{sa(b-1)}{c(ab-1)}$. The inequality we want to solve is

$$\frac{b-1}{ab-1} + \frac{a-1}{ab-1} + \frac{a(b-1)}{c(ab-1)} + \frac{b(a-1)}{d(ab-1)} > 1; \quad (3.33)$$

The infinite sequence of solutions are listed in table. 35, and the sporadic solutions are listed in table. 36.

(r,s,1,t)	(r,s,t,1)	(2,2,2,s)	(2,2,s,2)	(2,r,2,s)
(r,2,s,2)	(2,s,3,2)	(2,s,4,2)	(s,2,2,2)	(s,2,2,3)
(s,2,2,4)	(r,s,2,2)	(2,s,3,3)	(s,2,3,3)	(3,s,2,3)
(3,s,2,4)	(3,s,3,2)	(s,3,2,3)	(s,3,3,2)	(s,3,4,2)
(4,s,2,3)	(s,4,3,2)			

Table 35. Infinite sequence of type XVII singularity.

(2,3,k,2)	$2 < k < 8$	(2,4,k,2)	$3 < k < 6$	(2,5,k,2)	$4 < k < 6$
(3,2,2,k)	$2 < k < 8$	(4,2,2,k)	$3 < k < 6$	(2,3,3,k)	$2 < k < 5$
(3,3,2,k)	$2 < k < 6$	(3,4,2,k)	$3 < k < 6$	(3,3,k,2)	$2 < k < 6$
(3,4,k,2)	$3 < k < 5$	(4,3,k,2)	$3 < k < 6$	(5,k,2,3)	$4 < k < 9$
(4,k,3,2)	$3 < k < 10$	(5,k,3,2)	$4 < k < 7$	(k,4,2,3)	$4 < k < 10$
(k,5,2,3)	$5 < k < 7$	(k,5,3,2)	$5 < k < 9$	(3,2,3,3)	(3,2,4,3)
(4,3,2,4)					

Table 36. Sporadic sequence of type XVII singularity.

3.18 Type XVIII

The singularity has the form $f = z_0^a z_2 + z_0 z_1^b + z_1 z_2^c + z_1 z_3^d + z_2^p z_3^q$ with the constraint $\frac{p(a(b-1)+1)}{abc+1} + \frac{qc[a(b-1)+1]}{d(abc+1)} = 1$. The inequality we want to solve is

$$\frac{b(c-1)+1}{abc+1} + \frac{c(a-1)+1}{abc+1} + \frac{a(b-1)+1}{c(abc+1)} + \frac{c(a(b-1)+1)}{d(abc+1)} > 1; \quad (3.34)$$

The infinite sequence of solutions are listed in table. 37, while the sporadic sequence of solutions are listed in table. 38.

3.19 Type XIX

The singularity is $f = z_0^a z_2 + z_0 z_1^b + z_2^c z_1 + z_2 z_3^d$, and the inequality is

$$\left(\frac{[b(d(c-1)+1)-1]}{abcd-1}, \frac{[d(c(a-1)+1)-1]}{abcd-1}, \frac{[a(b(d-1)+1)-1]}{abcd-1}, \frac{[c(a(b-1)+1)-1]}{abcd-1} \right) > 1. \quad (3.35)$$

$(1,r,s,t)$	$(r,1,s,t)$	$(r,s,1,t)$	$(r,s,t,1)$	$(2,2,2,s)$
$(2,2,s,2)$	$(2,2,s,3)$	$(2,r,s,2)$	$(3,2,s,2)$	$(2,s,2,2)$
$(2,s,2,3)$	$(2,s,2,4)$	$(s,2,2,2)$	$(r,s,2,2)$	$(2,s,3,3)$
$(3,s,2,3)$	$(3,s,3,2)$	$(3,s,4,2)$	$(4,s,3,2)$	

Table 37. Infinite sequence of type XVIII singularity.

$(2,2,3,k)$	$2 < k < 9$	$(2,2,4,k)$	$3 < k < 6$	$(2,2,k,4)$	$4 < k < 8$
$(2,3,2,k)$	$2 < k < 10$	$(2,4,2,k)$	$3 < k < 7$	$(2,5,2,k)$	$4 < k < 6$
$(3,2,2,k)$	$2 < k < 8$	$(4,2,2,k)$	$3 < k < 5$	$(4,2,k,2)$	$3 < k < 8$
$(2,k,2,5)$	$5 < k < 8$	$(k,2,2,3)$	$3 < k < 8$	$(k,2,3,2)$	$3 < k < 9$
$(k,2,4,2)$	$4 < k < 6$	$(2,3,3,k)$	$2 < k < 5$	$(2,3,k,3)$	$3 < k < 9$
$(2,4,k,3)$	$3 < k < 6$	$(2,k,4,3)$	$4 < k < 8$	$(3,3,2,k)$	$2 < k < 5$
$(3,3,k,2)$	$2 < k < 10$	$(3,4,k,2)$	$3 < k < 7$	$(3,5,k,2)$	$4 < k < 6$
$(3,k,5,2)$	$5 < k < 8$	$(k,3,2,3)$	$3 < k < 6$	$(k,3,3,2)$	$3 < k < 7$
$(4,k,2,3)$	$3 < k < 6$	$(5,k,3,2)$	$4 < k < 6$	$(3,2,3,3)$	$(3,2,4,3)$
$(2,4,3,4)$	$(4,3,4,2)$	$(5,4,3,2)$			

Table 38. Sporadic sequence of type XVIII singularity.

The infinite sequence of solutions are listed in table. 39, and the sporadic sequence of solutions are listed in table. 40.

$(1,r,s,t)$	$(2,r,s,2)$	$(2,2,s,3)$
-------------	-------------	-------------

Table 39. Infinite sequence of type XIX singularity.

$(2,2,k,4)$	$3 < k < 9$	$(2,3,k,3)$	$2 < k < 8$	$(2,3,3,k)$	$3 < k < 6$
$(2,2,5,5)$	$(2,4,4,3)$				

Table 40. Sporadic sequence of type XIX singularity.

4 Beyond hypersurface singularity

After classifying the hypersurface singularity, we would like to generalize the story to other type of singularities. We will discuss three other constructions: a): Isolated complete intersection singularity (ICIS) with a \mathbb{C}^* action. b): If there is a finite group action G acting on ICIS and G is also required to preserve the canonical three form, we can form the quotient and this seems to also define new theories; ; c): Instead of considering isolated singularity, we could consider non-isolated singularity. Finally we conjecture that most

general type of isolated singularity that would give us a $\mathcal{N} = 2$ SCFT is rational graded Gorenstein singularity.

After describing the structure of singularity, there are three quantities which are of importance to us:

- $\mathcal{N} = 2$ Geometry: The first object is the mini-versal deformation of the singularity, and we would like to determine the dimension of the base and the scaling dimension of the parameters parameterizing the base.
- The second important quantity is the dimension of the middle homology group of Milnor fibration, and we would also like to determine the intersection form using distinguished basis associated with the vanishing cycle.
- The third quantity is the number of co-dimension one singularities after the generic deformations.

For Hypersurface singularity, the above three dimensions are the same and equal to the Milnor number μ . For other more general singularities considered in this section, these three quantities are usually not the same. The story for ICIS is almost the same as the hypersurface case, and the quotient singularity has also been studied but less well understood, finally the non-isolated singularity has least understanding.

We do not attempt here to provide full classification of all these constructions, we simply discuss the major features and provide simple examples, and we hope to classify them in the future work.

4.1 Complete intersection

The theory for isolated completed intersection singularity (ICIS) can be found in [24, 25]. The singularity is defined as the map $f : (\mathbb{C}^{n+3}, 0) \rightarrow (\mathbb{C}^n, 0)$. Let's take the coordinates on \mathbb{C}^{n+3} as z_1, \dots, z_{n+3} , the singularity is defined as

$$f_1(z_1, \dots, z_{n+3}) = f_2(z_1, \dots, z_{n+3}) = \dots = f_n(z_1, \dots, z_{n+3}) = 0 \quad (4.1)$$

We require f_i to satisfy the following conditions:

- Each polynomial f_i is quasi-homogeneous with degree d_i , and the weights of the coordinates z_i are w_i . We assume that d_i and w_i are integers.
- The variety is required to be complete intersection, namely for the Jacobi matrix

$$\frac{\partial f_a}{\partial z_i}, \quad a = 1, \dots, n, \quad i = 1, \dots, n+3 \quad (4.2)$$

has rank n everywhere except origin.

- There is an isolated singularity at the origin, namely, there is a unique solution $z_i = 0$ for the equations

$$\begin{aligned} f_1 = f_2 = \dots = f_n = 0 \\ \frac{\partial f_a}{\partial z_i} = 0, \quad a = 1, \dots, n, \quad i = 1, \dots, n+3. \end{aligned} \quad (4.3)$$

- The weights have to satisfy the condition $\sum w_i - \sum d_i > 0$, and a derivation of this fact will be given later.

The deformations are again related to the Jacobi module of the defining equations.

$$J(f) = C^n(z_0, z_1, \dots, z_{n+3}) / \left(\frac{\partial f_\alpha}{\partial z_j} \right). \quad (4.4)$$

This vector space is finite dimensional if the singularity is isolated. Let's use f to denote the Column vector (f_1, \dots, f_n) , and e_i to denote the basis of Jacobi module, then the mini-versal deformation of the singularity is

$$F(z, \lambda) = f + \sum_{i=1}^{\mu} \lambda_i e_i, \quad (4.5)$$

here again μ is the Milnor number which is equal to the dimension of the Jacobi module.

We would like to find the scaling dimension for the coefficient before each deformation. As the $U(1)_R$ symmetry of $\mathcal{N} = 2$ theory is proportional to the \mathbb{C}^* action, we would like to find the proportional constant. To do that, we again require that the canonical three form has scaling dimension one. There is a canonical $(3, 0)$ form which is defined as

$$\Omega = \frac{dz_1 \wedge dz_2 \dots \wedge dz_{n+3}}{df_1 \wedge df_2 \dots \wedge df_n}, \quad (4.6)$$

The weights of Ω is $\sum_i w_i - \sum d_i$, and we require Ω to have scaling dimension one:

$$\left(\sum_i w_i - \sum d_i \right) \delta = 1, \quad (4.7)$$

so $\delta = \frac{1}{(\sum_i w_i - \sum d_i)}$. For a deformation $\lambda_\alpha e_\alpha$, the scaling dimension would be

$$[\lambda_\alpha] = \frac{d_\alpha - Q_\alpha}{(\sum_i w_i - \sum d_i)}, \quad (4.8)$$

Here d_α is the degree of the polynomial f_α such that λ_α appears. We require Ω to have positive scaling dimension, so $\sum_i w_i - \sum_i d_i > 0$ which is a simple generalization of the constraint on hypersurface singularity.

Other physical quantities such as the central charges, low energy effective actions and the BPS quiver have the similar identifications as the geometric quantity, though the details are often much more involved than the hypersurface case. We are not going to discuss any details here, and we only make two comments: The first comment is that the number of co-dimensional one singularities are not equal to the Milnor number, which is different from the hypersurface case. The number is $m = \mu + \mu'$ with μ the Milnor number and μ' is the Milnor number of ICIS defined by taking a polynomial out. This polynomial is chosen such that the remaining equations still define an isolated complete intersection singularity. The second comment is that the constraint $\sum w_i - \sum d_i$ is pretty strong, and we conjecture that maximal number of defining polynomials are two.

Example: Let's consider a complete intersection of two quadratics $I = (f_1, f_2) = (z_1^2 + z_2^2 + z_3^2 + z_4^2, a_1 z_1^2 + a_2 z_2^2 + a_3 z_3^2 + a_4 z_4^2 + a_5 z_5^2)$, and a_i is required to be distinct so that there is an isolated singularity at the origin. The miniversal deformations of this singularity can be found using the software **Singular** [40]. The Milnor number is 9, and the basis of the Jacobi module is

$$\begin{pmatrix} 0 \\ z_5^2 \end{pmatrix}, \begin{pmatrix} 0 \\ z_5 \end{pmatrix}, \begin{pmatrix} 0 \\ z_4^2 \end{pmatrix}, \begin{pmatrix} 0 \\ z_4 \end{pmatrix}, \begin{pmatrix} 0 \\ z_3 \end{pmatrix}, \begin{pmatrix} 0 \\ z_2 \end{pmatrix}, \begin{pmatrix} 0 \\ z_1 \end{pmatrix}, \begin{pmatrix} 0 \\ 1 \end{pmatrix}, \begin{pmatrix} 1 \\ 0 \end{pmatrix}. \quad (4.9)$$

So the miniversal deformations are

$$(f_1 + \lambda_1, f_2 + \lambda_2 z_5^2 + \lambda_3 z_5 + \lambda_4 z_4^2 + \lambda_5 z_4 + \lambda_6 z_3 + \lambda_7 z_2 + \lambda_8 z_1 + \lambda_9). \quad (4.10)$$

Using our formula for the scaling dimensions 4.8, we find that there are five mass parameters, two operators with scaling dimension two and two operators with scaling dimension zero. There is a theory with the same type of spectrum: in class S theory, one can engineer a theory by putting 6d A_1 theory on a sphere with five regular punctures, and this theory has the same spectrum as the the above theory engineered using the ICIS. We compute the central charges of these two theories and they are equal, and this is a strong evidence that these two theories are the same. It would be interesting to find more evidence to check whether these two theories are the same or not.

4.2 Quotient by finite group

If the ICIS has finite group symmetries G preserving the three form Ω , we can consider new singularity formed by quotient of this group G . For simplicity, we only consider hypersurface singularity, then the invariance under finite group G implies that

$$f(T_g(z)) = f(z). \quad (4.11)$$

One can get a quotient space X/G which also has an isolated singularity at the origin. Similarly one can define the Milnor fibration of the quotient space, and we would like to determine the dimension $\hat{\mu}$ of the middle homology of the Milnor fibration. In the case of hypersurface, this number is equal to the dimension of Jacobi algebra of the singularity. In the quotient case, it is shown that the group action also acts on the homology, and the invariant subspace is shown to be given by the following formula [41]:

$$\hat{\mu} = \frac{1}{|G|} \sum_g (-1)^{d_g} \mu_g; \quad (4.12)$$

Here d_g is the codimension of the space in \mathbb{C}^4 which is fixed by the group element g , and μ_g is the dimension of the following vector space

$$V_g / \left(\frac{\partial f}{\partial z_i} \right)_g; \quad (4.13)$$

Here V_g is the space invariant under the group element g and $(\frac{\partial f}{z_i})_g$ is the Jacobi ideal which is invariant under g . This formula is the generalization of the formula of the hypersurface singularity in which the Milnor number is equal to the dimension of the Jacobi algebra. However, this is only part of middle homology groups of Milnor fibration, and we need to add more elements which is an analog of twisted sector in the study of orbifold. We do not have a complete story to discuss here, and in the following we give a simple example to illustrate the major point.

Example I: Consider a case where there is a \mathbb{Z}_2 action acting on a single coordinates z_3 , then there are two elements $(1, g)$, and the space fixed by g is a three dimensional space specified by the coordinates z_0, z_1, z_2 , so its codimension is one. Then the dimension of invariant part of homology group is given by $\hat{\mu}$:

$$\begin{aligned}\hat{\mu} &= \frac{1}{2}(\mu - \mu_g); \\ \mu &= \dim \frac{C(z_0, z_1, z_2, z_3)}{(\frac{\partial f}{z_0}, \frac{\partial f}{z_1}, \frac{\partial f}{z_2}, \frac{\partial f}{z_3})}; \\ \mu_g &= \dim \frac{C(z_0, z_1, z_2)}{(\frac{\partial f}{\partial z_0}|_{z_3=0}, \frac{\partial f}{\partial z_1}|_{z_3=0}, \frac{\partial f}{\partial z_2}|_{z_3=0}, \frac{\partial f}{\partial z_3}|_{z_3=0})}.\end{aligned}\quad (4.14)$$

This gives the number of vanishing three cycle, there are also hemi-cycles whose number can be determined by the fact that the dimension of middle homology of the Milnor vibration is equal to the dimension of mini-versal deformation.

We can give an explicit description for the deformation if there is only a \mathbb{Z}_2 action acting on one of the coordinates z_3 , then using the coordinates $\hat{z}_3 = z_3^2$, the singularity is represented by a polynomial \hat{f} . The basis for the mini-versal deformation is given by the basis of the following Jacobi algebra

$$C(z_0, z_1, z_2, \hat{z}_3) / \left(\frac{\partial \hat{f}}{\partial z_0}, \frac{\partial \hat{f}}{\partial z_1}, \frac{\partial \hat{f}}{\partial z_2}, \hat{z}_3 \frac{\partial \hat{f}}{\partial \hat{z}_3} \right) \quad (4.15)$$

Let's use ϕ_i as the basis of this algebra, then the miniversal deformation is

$$F(z_0, z_1, z_2, \hat{z}_3, \lambda) = f(z_0, z_1, z_2, \tilde{z}_3) + \sum_{i=1}^{\mu(\hat{f})} \lambda_i \phi_i. \quad (4.16)$$

Once we find out the number $\mu(\hat{f})$, and we know the number of vanishing homology group, we can easily find out the number of hemispheres $\mu_{hemi} = \mu(\hat{f}) - \hat{\mu}$. More general discussion on the quotient appearing in the Landau-Ginzburg context can be found in [42].

Example II: Let's consider the following ADE singularity

$$\begin{aligned}A_{2k-1} : & \quad f = z_0^2 + z_1^2 + z_2^2 + z_3^{2k}, \\ D_{k+1} : & \quad f = z_0^2 + z_1^2 + z_2^k + z_3^2, \\ E_6 : & \quad f = z_0^2 + z_1^2 + z_2^3 + z_3^4.\end{aligned}\quad (4.17)$$

There is a Z_2 acting on above singularity whose action is simply $Z_2 : z_3 \rightarrow -z_3$ (One can impose $z_0 \rightarrow -z_0$ to ensure the invariance for the three form.). The new singularity and the miniversal deformations are

$$\begin{aligned}
B_k : \quad & \hat{f} = z_0^2 + z_1^2 + z_2^2 + \hat{z}_3^k, \\
& F(z, \lambda) = \hat{f} + \lambda_1 \hat{z}_3^{k-1} + \dots + \lambda_{k-1} \hat{z}_3 + \lambda_k, \\
C_k : \quad & \hat{f} = z_0^2 + z_1^2 + z_2^k + z_2 \hat{z}_3, \\
& F(z, \lambda) = \hat{f} + \lambda_1 z_2^{k-1} + \dots + \lambda_{k-1} z_2 + \lambda_k, \\
F_4 : \quad & \hat{f} = z_0^2 + z_1^2 + z_2^3 + \hat{z}_3^2, \\
& F(z, \lambda) = \hat{f} + \lambda_1 z_2 + \lambda_2 \hat{z}_3 + \lambda_3 z_2 \hat{z}_3 + \lambda_4.
\end{aligned} \tag{4.18}$$

The scaling dimension of the coefficients can be found from the original theory, i.e. the spectrum is a truncation of the original theory. We conjecture that those theories are the maximal AD points at the Coulomb branch of the corresponding pure G gauge theory. The name is reflected in the fact that the intersection form of them have the same form as the corresponding Dynkin diagram. The remaining G_2 theory could be derived from taking a Z_3 quotient of D_4 singularity. We actually find several new rank one examples associated with B_2, B_3, C_2, C_3, G_2 Dynkin diagrams. Notice that B_k and C_k theory have the same spectrum from the SW curve, but their BPS quivers are different. We have seen before that for the hypersurface singularity, the spectrum of SW solution seem to complete characterize a theory, here we found theories which share the same $\mathcal{N} = 2$ geometry, but with different massive spectrum. It is interesting to further clarify what this means for the classification of $\mathcal{N} = 2$ theory.

4.3 General isolated singularity

One might ask what is the most general type of isolated singularity that would give us a four dimensional $\mathcal{N} = 2$ SCFT? As we described earlier, the necessary conditions are

- The singularity should have a \mathbb{C}^* action to reflect the existence of $U(1)_R$ symmetry of the SCFT.
- The SW geometry is described by the certain minimal deformation of the singularity, and the spectrum from the singularity should satisfy the pairing condition $[m] + [u] = 2$.
- One need to have a SW differential defined on SW geometry to describe the mass of BPS particles, and we expect that this differential is also well defined on the singularity.

Let's now assume that the singularity is defined by an affine ring $R = \mathbb{C}[x_1, x_2, \dots, x_n]/I$, and the first condition means that the ring is graded, i.e. there is a \mathbb{C}^* action on the ring. The third condition means that the ring is Gorenstein ⁴ so that there is a canonical form

⁴See [43] for the definition of Gorenstein ring.

Ω , and since there is a \mathbb{C}^* action on the ring, Ω is graded and has weight t . We require that this grading to be positive

$$t > 0; \tag{4.19}$$

mathematically this defines a rational singularity [27]. The integration of Ω over three cycles in the deformed geometry should give the mass of BPS particle, so we require the scaling dimension of it to be one. Using the above condition, we can find the proportional constant between the scaling dimension and the \mathbb{C}^* charge:

$$t\delta = 1 \rightarrow \delta = \frac{1}{t}. \tag{4.20}$$

The deformation is now described by the Jacobi algebra, which is also graded. The scaling dimension of a coefficient before a basis vector ϕ_i in Jacobi algebra is

$$[\lambda_i] = \frac{Q_i}{t}; \tag{4.21}$$

An extremely interesting property of this Jacobi algebra is that there is a perfect paring between the charges of the deformations [44]

$$Q(m) + Q(u) = 2t \rightarrow [m] + [u] = 2. \tag{4.22}$$

So a rational Gorenstein graded isolated three-fold singularity seems to define a $\mathcal{N} = 2$ SCFT.

For the hypersurface isolated singularity with a \mathbb{C}^* action $f(\lambda_i^q z_i) = f(z_i)$, the rational condition is simply $\sum q_i > 1$ as we discussed in section II. One must be careful that usually there is a stabilization of singularity $f(z_i) + w_1^2$, and the base of deformation space is not affected, namely the Jacobi algebra is the same, however, the property of rationally is not invariant under the stabilization. For example, a three dimensional singularity $z_0^2 + z_1^3 + z_2^7$ is not a two dimensional rational singularity, but its stabilization $z_0^2 + z_1^3 + z_2^7 + z_3^2$ is a three dimensional rational singularity.

The specially about the rational singularity is that the dual graph is homotopy to a point [45], and this might be the indication that we can get a local SCFT. From string theory point of view, this condition is equivalent to that the string theory on it is stable [30]. We are not aware of any other obstruction to the existence of SCFT. It would be interesting to further classify all possible $\mathcal{N} = 2$ theory which can be engineered using three fold singularity. Among the interesting rational graded Gorenstein singularities are the toric singularities, quotient singularity \mathbb{C}^3/G where G is a finite subgroup of $SU(3)$, and we hope to come to study these singularities and its relation to $\mathcal{N} = 2$ SCFT in the future.

4.4 Non-isolated singularity and class \mathcal{S} theory

One could also consider the non-isolated singularity, and the interesting case is that there is a one-dimensional singular locus Σ . These type of singularities are less understood, see

[46] for some preliminary discussions. We would like to rephrase the class \mathcal{S} construction in the form of singularity theory. Consider the following singularity

$$x^2 + y^2 + v^N (t^n + \sum_{i=1}^n c_i t^{n-i} + 1) = 0 \quad (4.23)$$

here t is a \mathbb{C}^* variable and parameterizes a sphere with several punctures. If $f(t) = (t^n + \sum_{i=1}^n c_i t^{n-i} + 1) \neq 0$, we get a A_{N-1} singularity, so the singular locus is not a point but a one dimensional manifold. When $f(t)|_{t^*} = 0$ the singularity behavior needs further study. This singularity has a \mathbb{C}^* action if we assign charge 0 to the t variable, and the scaling dimension of v would be simply 1. This singularity describes the following quiver:

$$N - \underbrace{SU(N) - SU(N)}_{n-1} - N \quad (4.24)$$

The deformation of this singularity is described in [4], and it takes the following form

$$x^2 + y^2 + \prod_{i=1}^N (v - m_{Li}) t^n + \sum_{i=1}^{n-1} f_i(v) t^{n-i} + \prod_{i=1}^N (v - m_{Ri}) = 0 \quad (4.25)$$

with $f_v(i) = c_i v^N + m_i v^{N-1} + u_{2i} v^{N-2} + \dots + u_{Ni}$. The deformation theory of non-isolated singularity is quite complicated, and we hope that the above example could help us to understand better the non-isolated singularity.

5 Conclusion

Our philosophy of classifying 4d SCFT is similar to what is discussed in [31] in which they first define an isolated singularity with a good \mathbb{C}^* action, and then constrain the possible deformations. In our case, we only specify the singularity, and the deformations are taken as the mini-versal deformations, namely the minimal deformations such that all the other deformations are induced from it. It would be interesting to explore whether we can find new theories by allowing different deformation pattern. Alternatively, it might be the case that different deformation pattern actually gives us different singularities, and the deformation pattern is automatically encoded in the deformation theory of the singularities.

For the hypersurface singularities, we have listed all possible solutions which can define a SCFT. It would be very interesting to completely classify other construction such as complete intersection, quotient by discrete group, etc. The non-isolated singularity is much less understood in mathematical literature, and it is definitely interesting to understand better this situation as it would teach us about the structure of class \mathcal{S} theory.

In this paper, our main approach is to use geometric singularity and its deformation to study 4d SCFT. Alternatively, it seems that we can define a 4d SCFT by using any two dimensional $(2, 2)$ SCFT with central charge $\hat{c} < 2$, and the deformation of the field theory is related to the (c, c) chiral ring of 2d theory. It would be definitely interesting to try to classify 4d SCFT from this perspective.

The major point of this paper is to try to classify the singularities that lead to SCFT. There are many interesting physical questions such as structure of conformal manifold, RG flow, BPS spectrum, etc, and as we have shown here, the singularity theory plays an amazing role in understanding those physical quantities. The detailed study will be left for the other papers of this series. Other aspects such the calculation of superconformal index [47–51] and associated chiral algebra [52] are also interesting to study from singularity theory point of view.

Acknowledgements

We would like to thank Stephen S.T. Yau, Y.F. Wang and especially C. Vafa for helpful discussions. The work of S.T Yau is supported by NSF grant DMS-1159412, NSF grant PHY- 0937443, and NSF grant DMS-0804454. The work of DX is supported by Center for Mathematical Sciences and Applications at Harvard University, and in part by the Fundamental Laws Initiative of the Center for the Fundamental Laws of Nature, Harvard University.

References

- [1] N. Seiberg and E. Witten, “Monopole condensation, and confinement in $N = 2$ supersymmetric Yang-Mills theory,” *Nucl. Phys.* **B426** (1994) 19–52, [arXiv:hep-th/9407087](#).
- [2] N. Seiberg and E. Witten, “Monopoles, duality and chiral symmetry breaking in $N=2$ supersymmetric QCD,” *Nucl.Phys.* **B431** (1994) 484–550, [arXiv:hep-th/9408099](#) [[hep-th](#)].
- [3] P. C. Argyres, M. Plesser, and A. D. Shapere, “The Coulomb phase of $N=2$ supersymmetric QCD,” *Phys.Rev.Lett.* **75** (1995) 1699–1702, [arXiv:hep-th/9505100](#) [[hep-th](#)].
- [4] E. Witten, “Solutions of four-dimensional field theories via M-theory,” *Nucl. Phys.* **B500** (1997) 3–42, [arXiv:hep-th/9703166](#).
- [5] P. C. Argyres and M. R. Douglas, “New phenomena in $SU(3)$ supersymmetric gauge theory,” *Nucl.Phys.* **B448** (1995) 93–126, [arXiv:hep-th/9505062](#) [[hep-th](#)].
- [6] P. C. Argyres, M. Ronen Plesser, N. Seiberg, and E. Witten, “New $N=2$ superconformal field theories in four-dimensions,” *Nucl.Phys.* **B461** (1996) 71–84, [arXiv:hep-th/9511154](#) [[hep-th](#)].
- [7] T. Eguchi, K. Hori, K. Ito, and S.-K. Yang, “Study of $N = 2$ Superconformal Field Theories in 4 Dimensions,” *Nucl. Phys.* **B471** (1996) 430–444, [arXiv:hep-th/9603002](#).
- [8] D. Gaiotto, “ $\mathcal{N} = 2$ dualities,” [arXiv:0904.2715](#) [[hep-th](#)].
- [9] D. Gaiotto, G. W. Moore, and A. Neitzke, “Wall-crossing, hitchin Systems, and the WKB approximation,” [arXiv:0907.3987](#) [[hep-th](#)].
- [10] D. Xie, “General Argyres-Douglas Theory,” *JHEP* **01** (2013) 100, [arXiv:1204.2270](#) [[hep-th](#)].
- [11] Y. Wang and D. Xie, “Classification of Argyres-Douglas theories from M5 branes,” [arXiv:1509.00847](#) [[hep-th](#)].

- [12] O. Chacaltana, J. Distler, and Y. Tachikawa, “Nilpotent orbits and codimension-two defects of 6d $N=(2,0)$ theories,” *Int.J.Mod.Phys. A* **28** (2013) 1340006, [arXiv:1203.2930 \[hep-th\]](#).
- [13] A. Klemm, W. Lerche, P. Mayr, C. Vafa, and N. P. Warner, “Selfdual strings and $N=2$ supersymmetric field theory,” *Nucl. Phys. B* **477** (1996) 746–766, [arXiv:hep-th/9604034 \[hep-th\]](#).
- [14] S. Katz, P. Mayr, and C. Vafa, “Mirror symmetry and exact solution of 4D $N = 2$ gauge theories. I,” *Adv. Theor. Math. Phys.* **1** (1998) 53–114, [arXiv:hep-th/9706110](#).
- [15] S. Gukov, C. Vafa, and E. Witten, “CFT’s from Calabi-Yau four folds,” *Nucl. Phys. B* **584** (2000) 69–108, [arXiv:hep-th/9906070 \[hep-th\]](#). [Erratum: Nucl. Phys. B608,477(2001)].
- [16] A. D. Shapere and C. Vafa, “BPS structure of Argyres-Douglas superconformal theories,” [arXiv:hep-th/9910182](#).
- [17] S. Cecotti, A. Neitzke, and C. Vafa, “R-Twisting and 4d/2d Correspondences,” [arXiv:1006.3435 \[hep-th\]](#).
- [18] S. Cecotti and M. Del Zotto, “On Arnold’s 14 ‘exceptional’ $N=2$ superconformal gauge theories,” *JHEP* **10** (2011) 099, [arXiv:1107.5747 \[hep-th\]](#).
- [19] M. Del Zotto, “More Arnold’s $N = 2$ superconformal gauge theories,” *JHEP* **11** (2011) 115, [arXiv:1110.3826 \[hep-th\]](#).
- [20] M. Del Zotto, C. Vafa, and D. Xie, “Geometric Engineering, Mirror Symmetry and 6d $(1,0) \rightarrow 4d, N=2$,” [arXiv:1504.08348 \[hep-th\]](#).
- [21] S. H. Katz, A. Klemm, and C. Vafa, “Geometric engineering of quantum field theories,” *Nucl. Phys. B* **497** (1997) 173–195, [arXiv:hep-th/9609239 \[hep-th\]](#).
- [22] S. S.-T. YAU and Y. YU, “Classification of 3-dimensional isolated rational hypersurface singularities with c -action,” *JOURNAL OF MATHEMATICS* **35** (2005) no. 5, .
- [23] V. I. Arnold, A. Varchenko, and S. Gusein-Zade, *Singularities of Differentiable Maps: Volume I: The Classification of Critical Points Caustics and Wave Fronts*, vol. 82. Springer Science & Business Media, 2012.
- [24] V. I. Arnold, A. N. Varchenko, and S. M. Gusein-Zade, *Singularities of Differentiable Maps: Volume II Monodromy and Asymptotic Integrals*, vol. 83. Springer Science & Business Media, 2012.
- [25] E. Looijenga, *Isolated singular points on complete intersections*, vol. 77. Cambridge University Press, 1984.
- [26] A. Dimca, *Singularities and topology of hypersurfaces*. Springer Science & Business Media, 2012.
- [27] S. Ishii, “Introduction to singularity theory,” 1997.
- [28] Y. Tachikawa, “ $N=2$ supersymmetric dynamics for pedestrians,” in *Lecture Notes in Physics, vol. 890, 2014*, vol. 890, p. 2014. 2013. [arXiv:1312.2684 \[hep-th\]](#).
- [29] H. Ooguri and C. Vafa, “Two-dimensional black hole and singularities of CY manifolds,” *Nucl. Phys. B* **463** (1996) 55–72, [arXiv:hep-th/9511164 \[hep-th\]](#).
- [30] A. Giveon, D. Kutasov, and O. Pelc, “Holography for noncritical superstrings,” *JHEP* **10** (1999) 035, [arXiv:hep-th/9907178 \[hep-th\]](#).

- [31] P. Argyres, M. Lotito, Y. L., and M. Martone, “Geometric constraints on the space of N=2 SCFTs I: physical constraints on relevant deformations,” [arXiv:1505.04814 \[hep-th\]](#).
- [32] S. Cecotti and C. Vafa, “Classification of complete N=2 supersymmetric theories in 4 dimensions,” [arXiv:1103.5832 \[hep-th\]](#).
- [33] A. D. Shapere and Y. Tachikawa, “Central charges of N=2 superconformal field theories in four dimensions,” *JHEP* **0809** (2008) 109, [arXiv:0804.1957 \[hep-th\]](#).
- [34] E. Witten, “On S duality in Abelian gauge theory,” *Selecta Math.* **1** (1995) 383, [arXiv:hep-th/9505186 \[hep-th\]](#).
- [35] M. Buican, S. Giacomelli, T. Nishinaka, and C. Papageorgakis, “Argyres-Douglas Theories and S-Duality,” *JHEP* **02** (2015) 185, [arXiv:1411.6026 \[hep-th\]](#).
- [36] S. Cecotti and M. Del Zotto, “Higher S-dualities and Shephard-Todd groups,” *JHEP* **09** (2015) 035, [arXiv:1507.01799 \[hep-th\]](#).
- [37] K. Saito, “Einfach-elliptische singularitäten,” *Inventiones mathematicae* **23** (1974) no. 3, 289–325.
- [38] D. Xie and P. Zhao, “Central charges and RG flow of strongly-coupled N=2 theory,” *JHEP* **03** (2013) 006, [arXiv:1301.0210](#).
- [39] J. N. Mather and S. S.-T. Yau, “Classification of isolated hypersurface singularities by their moduli algebras,” *Inventiones mathematicae* **69** (1982) no. 2, 243–251.
- [40] W. Decker, G.-M. Greuel, G. Pfister, and H. Schönemann, “SINGULAR 4-0-2 — A computer algebra system for polynomial computations.” <http://www.singular.uni-kl.de>, 2015.
- [41] C. Wall, “A note on symmetry of singularities,” *Bulletin of the London Mathematical Society* **12** (1980) no. 3, 169–175.
- [42] K. Intriligator and C. Vafa, “Landau-ginzburg orbifolds,” *Nuclear Physics B* **339** (1990) no. 1, 95–120.
- [43] D. Eisenbud, *Commutative Algebra: with a view toward algebraic geometry*, vol. 150. Springer Science & Business Media, 1995.
- [44] J. M. Wahl *et al.*, “The jacobian algebra of a graded gorenstein singularity,” *Duke Mathematical Journal* **55** (1987) no. 4, 843–871.
- [45] D. Stepanov, “A note on resolution of rational and hypersurface singularities,” *Proceedings of the American Mathematical Society* **136** (2008) no. 8, 2647–2654.
- [46] V. Arnold, “Dynamical system viii: Singularity theory ii-applications,”.
- [47] A. Gadde, L. Rastelli, S. S. Razamat, and W. Yan, “Gauge Theories and Macdonald Polynomials,” *Commun. Math. Phys.* **319** (2013) 147–193, [arXiv:1110.3740 \[hep-th\]](#).
- [48] M. Buican and T. Nishinaka, “On the Superconformal Index of Argyres-Douglas Theories,” [arXiv:1505.05884 \[hep-th\]](#).
- [49] C. Cordova and S.-H. Shao, “Schur Indices, BPS Particles, and Argyres-Douglas Theories,” [arXiv:1506.00265 \[hep-th\]](#).
- [50] M. Buican and T. Nishinaka, “Argyres-Douglas Theories, the Macdonald Index, and an RG Inequality,” [arXiv:1509.05402 \[hep-th\]](#).
- [51] J. Song, “Superconformal indices of generalized Argyres-Douglas theories from 2d TQFT,” [arXiv:1509.06730 \[hep-th\]](#).

- [52] C. Beem, W. Peelaers, L. Rastelli, and B. C. van Rees, “Chiral algebras of class S,” *JHEP* **05** (2015) 020, [arXiv:1408.6522 \[hep-th\]](#).