

# Non-Abelian $SU(3)_k$ anyons: inversion identities for higher rank face models

Holger Frahm and Nikos Karaiskos\*

*Institut für Theoretische Physik, Leibniz Universität Hannover,  
Appelstraße 2, 30167 Hannover, Germany*

(Dated: August 26, 2015)

The spectral problem for an integrable system of particles satisfying the fusion rules of  $SU(3)_k$  is expressed in terms of exact inversion identities satisfied by the commuting transfer matrices of the integrable fused  $A_2^{(1)}$  interaction round a face (IRF) model of Jimbo, Miwa and Okado. The identities are proven using local properties of the Boltzmann weights, in particular the Yang-Baxter equation and unitarity. They are closely related to the consistency conditions for the construction of eigenvalues obtained in the Separation of Variables approach to integrable vertex models.

## I. INTRODUCTION

Studies of integrable models [1–4] in low dimensions have provided important insights into the exotic properties of the quasiparticle excitations in a correlated many-body system subject to strong quantum fluctuations. Particularly exotic objects are the non-Abelian anyons with unconventional quantum statistics expected to be realized in certain fractional quantum Hall states [5, 6]: interchanging these quasi-particles can be described by a unitary rotation on the manifold of robust degenerate states supported by a collection of a few of them. These degeneracies will be lifted by interactions between the anyons and the formation of collective states has been studied in models of interacting anyons with given fusion and braiding properties [7–12].

In this context, the local lattice Hamiltonians generated by the commuting transfer matrix of integrable restricted solid on solid (RSOS) models [13] and their generalizations [14–17] have recently attracted renewed interest, see e.g. [7, 18, 19]. In these lattice models the local state variables (spins) take values from a given set of representations of a Lie algebra  $\mathfrak{g}$ . The possible pairs of spins on adjacent sites are constrained by the fusion rules of the algebra [14, 16, 17], leading e.g. to the RSOS condition for  $SU(2)_k$  anyons. Below we consider such models relevant to anyons satisfying higher rank fusion rules, specifically of  $SU(n)_k$  for  $n = 3$ . This fusion algebra is a truncation of the category of irreducible representations (irreps) of the quantum group  $U_q[su(n)]$

---

\* Present Address: Max-Delbrück-Center for Molecular Medicine, Berlin, Germany

with  $q = \exp(2\pi i/(n+k))$  or, equivalently, the level- $k$  integrable representations of the Kac-Moody algebra  $A_{n-1}^{(1)} = \widehat{SU(n)}$ . Local Boltzmann weights for IRF models based on this algebra for anyons corresponding to the fundamental vector representation which satisfy a Yang-Baxter equation have been constructed by Jimbo, Miwa and Okado [15]. Using the fusion procedure the model has been further generalized to allow for arbitrary  $SU(n)_k$  anyons relating the admissible spins on neighbouring sites in the horizontal and vertical direction, respectively [20]. Based on the fusion hierarchy of functional equations satisfied by the corresponding transfer matrices the central charge and conformal weights of the conformal field theories describing the low energy collective excitations of the model have been computed [21, 22].

The goal of this paper is to provide a basis for a different approach towards the solution of the spectral problem of this model based on a set exact inversion identities satisfied by the transfer matrices (or their eigenvalues) of inhomogeneous generalizations of these models. For the six-vertex model and the related RSOS models with integrable periodic or open boundary conditions such identities have recently been derived from the underlying Yang-Baxter or reflection equations for the local vertex weights using certain physical assumptions such as crossing symmetry and unitarity [23, 24], for the vertex models they also arise in Sklyanin's separation of variables (SoV) approach [25]. Complemented with information on the analytical properties of the transfer matrix they can be related to the formulation of the spectral problem in the form of Baxter's TQ-equation [26] or inhomogeneous generalizations thereof which arise in models with non-diagonal boundary conditions breaking the  $U(1)$  bulk-symmetry of the vertex model [23, 27, 28]. For the six-vertex model, the equivalence of these formulations can be shown using the SoV approach where, in addition, the completeness of the spectrum has been proven [29].

Just as in these cases the Boltzmann weights of the  $SU(n)_k$  models considered below satisfy a unitarity condition. There is, however, no crossing symmetry for the face weights which prevents the straightforward extension of the results of Refs. [23, 24] to higher rank symmetries. Motivated by relations obtained from the fusion hierarchy of the integrable  $SU(3)$ -invariant vertex model and the corresponding SoV [30–32], we find that a closed set of discrete inversion identities can be formulated for *two* transfer matrices from the fusion hierarchy of the IRF model corresponding to adjacency conditions in the vertical direction induced by the anyon in the fundamental vector representation and its dual, respectively.<sup>1</sup>

Our paper is organized as follows: to introduce our notation we first briefly recall the definition of the  $SU(n)_k$  anyon (or  $A_{n-1}^{(1)}$  IRF) model and its algebraic structure. Then, motivated by the results

<sup>1</sup> Related identities for  $SU(n)$  vertex models with various boundary conditions have been constructed in Ref. [33].

for the  $SU(3)$  vertex model [30, 31, 34] summarized in the appendix, we introduce a generalized model based on fused Boltzmann weights and define the transfer matrices appearing in the inversion identities for the  $SU(3)_k$  model. The main result of this paper is the proof of these identities in Section IV A. The paper ends with a brief discussion.

## II. $SU(n)_k$ ANYON MODELS

Anyonic models can be decomposed into a finite set of topological sectors. The corresponding conserved charges obey a commutative and associative fusion algebra

$$\psi_a \otimes \psi_b \cong \bigoplus_c N_{ab}^c \psi_c \quad (2.1)$$

with non-negative integers  $N_{ab}^c$ . In a graphical representaton (to be read from top left to right) of fusion the vertex

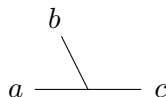

may occur provided that  $N_{ab}^c \neq 0$ . The fusion algebra places constraints on the allowed sequence of charges in the basis of fusion path states for a model of anyons  $\psi_x$

$$|\cdots a_{n-1} a_n a_{n+1} \cdots\rangle = \cdots \frac{\psi_x}{a_{n-1}} \frac{\psi_x}{a_n} \frac{\psi_x}{a_{n+1}} \cdots \quad (2.2)$$

i.e.  $\psi_{a_{n+1}}$  has to appear in the fusion  $\psi_{a_n} \otimes \psi_x$ .

### A. Local states and admissible pairs in the IRF model

For the  $SU(n)_k$  anyons considered in this paper the sectors are identified with certain irreducible representations of the quantum group  $U_q[su(n)]$  and the fusion algebra is given by the decomposition of their tensor products into irreps. Just as the level  $k$  dominant integral weights of  $A_{n-1}^{(1)}$  the topological sectors in the  $SU(n)_k$  anyon models are represented by vectors

$$a = \sum_{i=0}^{n-1} a_i \omega_i, \quad \sum_{i=0}^{n-1} a_i = k \quad (2.3)$$

with nonnegative integers  $a_i$  and  $\{\omega_i\}_{i=0}^{n-1}$  being the fundamental weights of  $A_{n-1}^{(1)}$  with  $\omega_n = \omega_0$ . For given  $k \geq 1$  the topological charges (or the spin variables in the IRF model) take values in the set

$\otimes$	[0, 0]	[1, 0]	[1, 1]	[2, 0]	[2, 1]	[2, 2]
[1, 0]	[1, 0]	[1, 1] $\oplus$ [2, 0]	[0, 0] $\oplus$ [2, 1]	[2, 1]	[1, 0] $\oplus$ [2, 2]	[1, 1]
[1, 1]	[1, 1]	[0, 0] $\oplus$ [2, 1]	[1, 0] $\oplus$ [2, 2]	[1, 0]	[1, 1] $\oplus$ [2, 0]	[2, 1]

TABLE I. Fusion rules for  $SU(3)_2$  anyons involving the fundamental anyons and their adjoints corresponding to the Young diagrams [1, 0] and [1, 1], respectively.

$P_+(n; k)$  of dominant weights (2.3). A convenient representation of these local states is in terms of Young diagrams  $[\lambda_1, \dots, \lambda_{n-1}]$  with  $\lambda_i$  nodes in the  $i^{\text{th}}$  row: for  $k \equiv \lambda_0 \geq \lambda_1 \geq \dots \geq \lambda_{n-1} \geq \lambda_n \equiv 0$  this diagram can be identified with the local state

$$a = \sum_{i=0}^{n-1} (\lambda_i - \lambda_{i+1}) \omega_i = \lambda_0 \omega_0 + \sum_{i=1}^{n-1} \lambda_i e_i \in P_+(n; k) \quad (2.4)$$

with the elementary vectors  $e_i = \omega_i - \omega_{i-1}$ . Two diagrams represent the same element if and only if one is obtained from the other by removal of columns of height  $n$ .

As discussed above the fusion algebra (2.1) leads to a set of constraints for an ordered pair of local states  $(a, b)$  with  $a, b \in P_+(n; k)$  to be admissible as a configuration on neighbouring sites of the lattice model. For a system of anyons  $\psi_{[\lambda]}$  corresponding to the Young diagram  $[\lambda]$  such a pair is allowed if  $N_{a[\lambda]}^b \neq 0$ . Considering anyons in the fundamental vector representation  $[1] \equiv [1, 0, \dots, 0]$  the vertex

$$\begin{array}{c} \psi_{[1]} \\ \diagdown \quad \diagup \\ a \text{ --- } b \end{array}$$

may occur in a fusion path state provided that

$$b = a + e_i, \quad \text{for some } i = 1, \dots, n, \quad (2.5)$$

see e.g. Table I for  $SU(3)_2$  anyons.

The set of local states and the constraints for a given type of anyons can be represented in an oriented graph with nodes labeled by elements of  $P_+(n; k)$  and arrows from node  $a$  to  $b$  representing an admissible pair  $(a, b)$ . The underlying fusion rules for  $\psi_{[\lambda]}$  anyons are encoded in the corresponding adjacency matrix  $A^{[\lambda]}$  with elements

$$\left( A^{[\lambda]} \right)_{ab} = N_{a[\lambda]}^b. \quad (2.6)$$

Note that for  $[\lambda]$  being a symmetric tensor or antisymmetric tensor the decomposition  $\psi_a \otimes \psi_{[\lambda]}$  is multiplicity free and the elements of the adjacency matrix are 0 or 1. The adjacency graph for the local states  $P_+(3; 2)$  in a system of  $\psi_{[1]}$  anyons is shown in Figure 1.

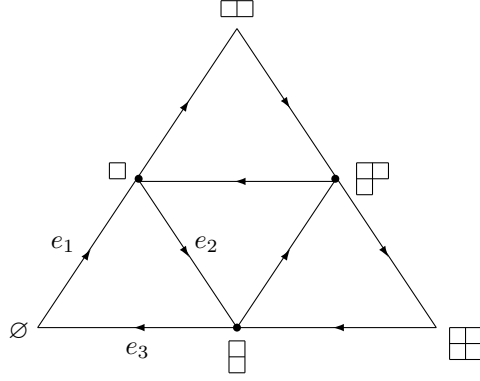

FIG. 1. Adjacency graph for the set of local states  $P_+(3;2)$ . Admissible pairs of states in the anyon model corresponding to the fundamental vector representation [1] are denoted by an arrow connecting the corresponding vertices. For anyons  $\psi_{[1^2]}$  in the adjoint representation the arrows would have to be reversed.

### B. Boltzmann weights

The  $A_{n-1}^{(1)}$  IRF model for  $SU(n)_k$  anyons in the vector representation [1] is defined on a square lattice, such that the spins on the corners of a face take values in  $P_+(n; k)$ . A Boltzmann weight corresponding to a configuration  $a, b, c, d$  round a face is depicted as

$$W \left( \begin{array}{cc|c} c & d & u \\ b & a & \end{array} \right) = \begin{array}{ccc} & c & d \\ \leftarrow & & \rightarrow \\ \uparrow & u & \uparrow \\ \leftarrow & & \rightarrow \\ & b & a \end{array}$$

It is non-vanishing if and only if the four pairs of variables  $(a, b)$ ,  $(b, c)$ ,  $(d, c)$ ,  $(a, d)$  are all admissible in the sense of (2.5). Their explicit expressions read [15]

$$\begin{aligned} W \left( \begin{array}{cc|c} a + 2e_i & a + e_i & u \\ a + e_i & a & \end{array} \right) &= r_1(u)[u + 1] \\ W \left( \begin{array}{cc|c} a + e_i + e_j & a + e_i & u \\ a + e_i & a & \end{array} \right) &= r_1(u) \frac{[u + a_{ji}][1]}{[a_{ji}]}, \quad \text{for } i \neq j \\ W \left( \begin{array}{cc|c} a + e_i + e_j & a + e_j & u \\ a + e_i & a & \end{array} \right) &= r_1(u) \frac{[u][a_{ji} - 1]}{[a_{ji}]}, \quad \text{for } i \neq j. \end{aligned} \quad (2.7)$$

For a state  $a \in P_+(n; k)$  given by Eq. (2.4),  $a_{ij}$  is defined as the inner product

$$a_{ij} = \langle a + \rho, e_i - e_j \rangle = j - i + \lambda_i - \lambda_j, \quad (2.8)$$

with  $\rho$  being the sum of fundamental weights. At criticality, the dependence of the Boltzmann weights on the spectral parameter  $u$  is given by trigonometric functions

$$[u] = \sin(u\eta), \quad \eta = \frac{\pi}{n+k}. \quad (2.9)$$

These weights satisfy the initial condition

$$W \left( \begin{array}{cc|c} c & d & \\ b & a & 0 \end{array} \right) \sim \delta_{bd}. \quad (2.10)$$

Notice also that at the special value  $u = -1$  the weights containing straight paths, that is from  $a \rightarrow a + 2e_i$ , are automatically excluded. The Boltzmann weights (2.7) satisfy the Yang-Baxter equation (YBE)

$$\begin{aligned} \sum_g W \left( \begin{array}{cc|c} a & g & \\ f & e & v \end{array} \right) W \left( \begin{array}{cc|c} a & b & \\ g & c & u \end{array} \right) W \left( \begin{array}{cc|c} g & c & \\ e & d & u+v \end{array} \right) \\ = \sum_g W \left( \begin{array}{cc|c} a & b & \\ f & g & u+v \end{array} \right) W \left( \begin{array}{cc|c} f & g & \\ e & d & u \end{array} \right) W \left( \begin{array}{cc|c} b & c & \\ g & d & v \end{array} \right), \end{aligned} \quad (2.11)$$

and an inversion relation which can be used to fix the normalization function  $r_1(u)$

$$\sum_g W \left( \begin{array}{cc|c} d & g & \\ a & b & u \end{array} \right) W \left( \begin{array}{cc|c} d & c & \\ g & b & -u \end{array} \right) = \delta_{ac} r_1^2(u) [1-u][1+u]. \quad (2.12)$$

There are additional symmetries, e.g. symmetrizability,  $Z_n$ -invariance and a duality, see [15] for details.

For the proof of the inversion identities below we use graphical representation of these local relations. In particular, the YBE may be depicted as

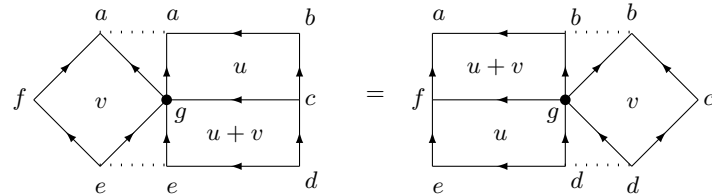

In this and in the following figures, nodes marked with a dot ( $\bullet$ ) represent spin variables which are summed over all possible local states and nodes with equal spins are connected with a dotted line.

Unitarity condition is depicted in a similar fashion as

$$= \delta_{ac} r_1^2(u) [1-u][1+u].$$

### C. Hecke algebra and projectors

The algebraic structure underlying the  $A_{n-1}^{(1)}$  RSOS models is connected with a quotient of the braid group, namely the Hecke algebra [21, 35, 36]. This connection leads to the construction of projection operators, which are used later in the text in order to prove the inversion identities satisfied by the transfer matrices.

Let first  $|a_0 \cdots a_{L+1}\rangle$  be a fusion path state (2.2) for the anyons considered, i.e. a sequence of local states  $a_i$  such that each pair  $(a_i, a_{i+1})$  is admissible. We define the Yang-Baxter operators by their action on these states as

$$W_i(u)|a_0 \cdots a_{L+1}\rangle = \sum_{b_i \in P_+(n;k)} W \left( \begin{array}{cc|c} a_{i-1} & a_i & u \\ b_i & a_{i+1} & \end{array} \right) |a_0 \cdots a_{i-1} b_i a_{i+1} \cdots a_{L+1}\rangle \quad (2.13)$$

for  $i = 1, \dots, L$ . In terms of the Yang-Baxter operators, the YBE (2.11) takes the form

$$W_i(u) W_{i+1}(u+v) W_i(v) = W_{i+1}(v) W_i(u+v) W_{i+1}(u), \quad (2.14)$$

which is reminiscent of the braid relation satisfied by the generators of the braid group. In fact, by proper choice of the normalization  $r_1(u)$  of the Boltzmann weights (2.7) these operators can be written as

$$W_i(u) = e^{-i\eta u} \mathbb{I} + e^{-i\eta} \frac{[u]}{[1]} X_i. \quad (2.15)$$

Here the  $X_i$ 's are independent of the spectral parameter and satisfy

$$\begin{aligned} X_i X_{i+1} X_i &= X_{i+1} X_i X_{i+1} \\ X_i^2 - (q-1)X_i - q &= 0 \\ [X_i, X_j] &= 0, \quad |i-j| > 1 \end{aligned} \quad (2.16)$$

with  $q = \exp(2i\eta) = \exp(2\pi i/(n+k))$  being the deformation parameter of the underlying quantum group  $U_q[su(n)]$ . This set of relations gives rise to a representation of the Hecke algebra  $H_{L+1}(q)$ . Note that in the  $n=2$  case, that is in the RSOS models, the Hecke algebra truncates essentially to the Temperley-Lieb algebra. As was pointed out in [21] one actually obtains the representation of the quotient of the Hecke algebra in which  $q$ -analogues of the full Young (anti-)symmetrizers  $(P_\ell^\pm)^2 = P_\ell^\pm$  for the  $SU(n)_k$  model can be defined. They act on (admissible) sequences of local states of length  $\ell+2$  and satisfy

$$\begin{aligned} P_n^-(i, \dots, i+n+1) &= 0, \quad \forall i \\ P_\ell^+(i, \dots, i+\ell+1) &= 0, \quad \forall i, \quad \ell = k+1, \dots, n+k-1. \end{aligned} \quad (2.17)$$

In terms of the Yang-Baxter operators they can be formally written as

$$P_\ell^\pm(0, \dots, \ell + 1) = \prod_{m=0}^{\ell-1} \left( \prod_{j=1}^{\ell-m} \frac{[1]}{[j+1]} W_j(\pm j) \right). \quad (2.18)$$

As an example, we have the following schematic representation for  $P_{1,2}^-$  (as before the spin variables  $c_j$  on dotted nodes are being summed over)

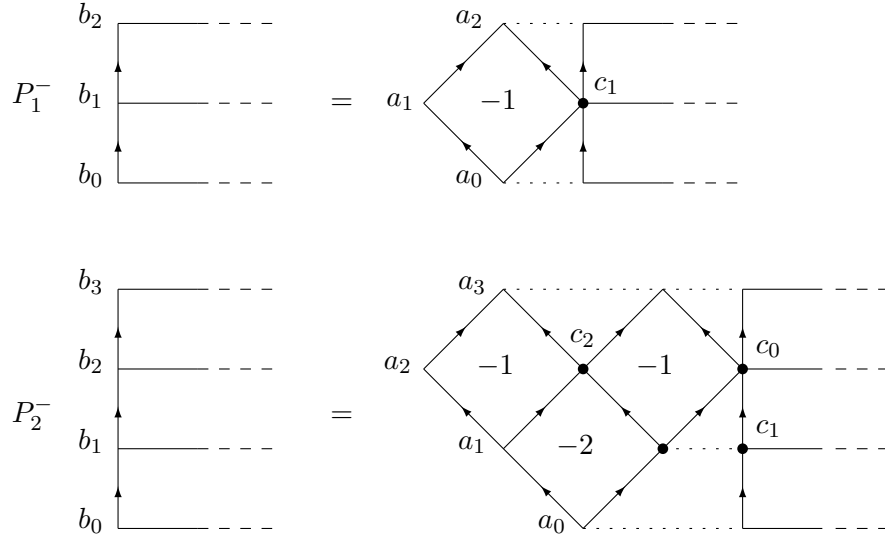

The action of the projectors can be deduced from the explicit expressions of the Boltzmann weights (2.7). First, one may observe that for  $u = -1$ , the first of the weights (2.7) is always zero. Hence the operator  $P_1^-$  projects out all states  $(a_2, a_0)$  which are connected by a straight line in the adjacency graph of local states  $P_+(n; k)$ , see Figure 1. Similarly, it can be shown that  $P_{n-1}^- |a_0 \cdots a_n\rangle \propto \delta_{a_n a_0}$  for any fusion path state  $|a_0 \cdots a_n\rangle$  of  $SU(n)_k$  anyons.

### III. FUSED $A_{n-1}^{(1)}$ IRF MODELS

#### A. Commuting transfer matrices

Starting with the set of Boltzmann weights (2.7) satisfying the Yang-Baxter equation we can define a family of transfer matrices generating the commuting integrals for a system of  $SU(n)_k$  anyons in the vector representation. Introducing local inhomogeneities  $\{u_k\}_{k=1}^L$  the first transfer





type of  $SU(n)_k$  anyons considered, for the present case of  $\psi_{[1]}$  we find

$$\Delta(u) = \prod_{k=1}^L \left( [u - u_k + 1] \prod_{\ell=1}^{n-1} [u - u_k - \ell] \right). \quad (3.5)$$

## B. Fusion of weights

Alternatively, the fused  $A_{n-1}^{(1)}$  IRF models can be constructed by means of the fusion procedure [20]. Boltzmann weights  $W^{[\lambda][\mu]}(u)$  with admissible pairs corresponding to fusion with the anyon  $\psi_{[\lambda]}$  ( $\psi_{[\mu]}$ ) along horizontal (vertical) links are obtained from the partition function for a suitably chosen rectangular block of the elementary ones (2.7) with properly shifted spectral parameters by projection onto the Young diagram  $[\lambda]$  ( $[\mu]$ ). In the present context where the admissible fusion path states in the horizontal direction are those of the  $SU(n)_k$  anyons  $\psi_{[1]}$  we can restrict ourselves to the vertically fused Boltzmann weights  $W^{[1][\mu]}(u)$ . Specifically, we consider the case of  $[\mu] = [1^2] \equiv [1, 1, 0, \dots]$  which can be obtained by fusion of two elementary weights.

Following the prescription used in Ref. [37] the fused Boltzmann weights are constructed graphically as follows (fused edges are represented by double lines on the corresponding link, as before arrows indicate the direction in which the constraint for admissible pairs is to be read)

$$W^{[1][1^2]} \left( \begin{array}{cc|c} a_2 & b_2 & \\ \hline a_0 & b_0 & u \end{array} \right) \equiv W_v \left( \begin{array}{cc|c} a_2 & b_2 & \\ \hline a_0 & b_0 & u \end{array} \right)$$

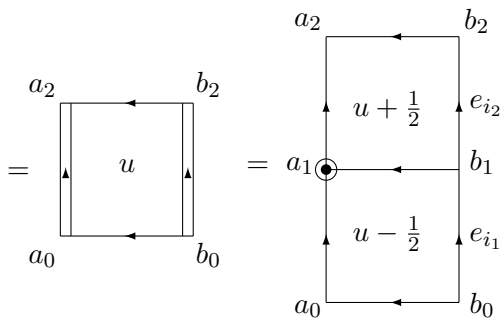

Here one has to perform an antisymmetrization on the nodes marked by  $\odot$ , in addition to summation over all possible values, corresponding to the projection onto  $[1^2]$ . The fused weights do not

depend on the spin  $b_1$ . They can be written in the compact form

$$\begin{aligned}
W_v \left( \begin{array}{cc|c} a + e_{i_k} + e_\Lambda & a + e_\Lambda & u \\ a + e_{i_k} & a & \end{array} \right) &= -r_2(u) \left[ u - \frac{1}{2} \right] \left[ u + \frac{1}{2} \right] \prod_{j=1}^2 \frac{[a_{i_j i_k} - 1]}{[a_{i_j i_k}]} \\
W_v \left( \begin{array}{cc|c} a + e_{i_k} + e_\Lambda & a + e_\Lambda & u \\ a + e_{i_m} & a & \end{array} \right) &= -r_2(u) \left[ u - \frac{1}{2} \right] \left[ u + \frac{1}{2} + a_{i_k i_m} \right] \frac{[1]}{[a_{i_k i_m}]} \prod_{\substack{j=1 \\ j \neq m}}^2 \frac{[a_{i_j i_m} - 1]}{[a_{i_j i_m}]} \\
W_v \left( \begin{array}{cc|c} a + e_\Lambda + e_{i_m} & a + e_\Lambda & u \\ a + e_{i_m} & a & \end{array} \right) &= -r_2(u) \left[ u - \frac{1}{2} \right] \left[ u + \frac{3}{2} \right] \prod_{\substack{j=1 \\ j \neq m}}^2 \frac{[a_{i_j i_m} - 1]}{[a_{i_j i_m}]},
\end{aligned} \tag{3.6}$$

where we have defined  $e_\Lambda = e_{i_1} + e_{i_2}$  and require that  $m \in \{1, 2\}$  and  $i_k \notin \{i_1, i_2\}$ . The spectral parameter dependent scalar factor  $r_2(u)$  is fixed by our choice of normalization of the elementary weights (2.7), see [37].

The antisymmetrization of the vertically fused weights allows to write them as a column of two weights, multiplied by the projector  $P_1^-$ , Eq. (2.18), excluding straight paths in the adjacency graph. In terms of a graphical representation, we have

This equivalence will turn out to be particularly useful when we consider the transfer matrices and their algebraic relations in the next section.

As a final note, it should be stressed out that these fused weights satisfy a set of Yang-Baxter relations, ensuring the preservation of integrability. In Figure 2 we represent the Yang-Baxter relations satisfied by the elementary and fused Boltzmann weights in addition to the initial one (2.11).

In terms of the vertically fused Boltzmann weights the transfer matrix (3.3) is written as

$$\begin{aligned}
\mathbf{U}(u) &= \left[ \begin{array}{cccccc} a_0 & a_1 & \dots & a_{k-1} & a_k & \dots & a_{L-1} & a_L \\ \left| \left| \left| \left| \left| \left| \left| \left| \right. \right. \right. \right. \right. \right. \right. \\ u - u_1 - \frac{1}{2} & \dots & u - u_k - \frac{1}{2} & \dots & u - u_L - \frac{1}{2} \\ \left| \left| \left| \left| \left| \left| \left| \left| \right. \right. \right. \right. \right. \right. \right. \\ c_0 & c_1 & \dots & c_{k-1} & c_k & \dots & c_{L-1} & c_L \end{array} \right] \\
&= \prod_{k=1}^L W_v \left( \begin{array}{cc|c} a_{k-1} & a_k & u - u_k - \frac{1}{2} \\ c_{k-1} & c_k & \end{array} \right),
\end{aligned} \tag{3.7}$$

relating it to the fused  $A_{n-1}^{(1)}$  IRF model based on fusion paths of  $\psi_{[1]}$  and  $\psi_{[12]}$  anyons in the horizontal and vertical direction, respectively. Similarly, the transfer matrices  $\mathbf{T}_\ell(u)$  are obtained



FIG. 2. The additional Yang-Baxter relations containing the fused Boltzmann weights (3.6). Double lines represent fusion along the particular direction. Indices and spectral parameters are suppressed for the sake of clarity.

from the IRF model with  $\psi_{[1^e]}$  anyons on the vertical links. We do not consider transfer matrices with anyons other than those related to these fundamental representations on the vertical links here. Based on our results below we conjecture that they are algebraic functions of the  $\mathbf{T}_\ell(u)$ , similar as in the integrable  $SU(n)$  vertex models [30, 34], thus do not provide additional information on the system.

Note that as a consequence of (3.6) we have  $\mathbf{U}(u_k+1) = 0$  for  $k = 1, \dots, L$ , resembling Eq. (A12) for the vertex model. This allows to extract a spectral parameter dependent factor from the second transfer matrix

$$\mathbf{U}(u) = \left( \prod_{k=1}^L [u - u_k - 1] \right) \tilde{\mathbf{U}}(u). \quad (3.8)$$

#### IV. INVERSION IDENTITIES FOR THE $A_2^{(1)}$ IRF MODEL

Motivated by the results for the  $SU(3)$  vertex model given in the Appendix, our aim is to transfer them to the face model. Initially, the  $A_1^{(1)}$  or RSOS models have been introduced by Baxter in order to solve the eight-vertex model [38–40]. The observed correspondence between Boltzmann weights of faces in the RSOS models and vertices in the eight-vertex model turns out to be quite generic and can be formulated based on the identification of equivalent operators in face and vertex models, respectively [41]. For the  $A_{n-1}^{(1)}$  IRF models the face/vertex correspondence was stated in Ref. [20].

As we have seen above many of the quantities arising from the integrable structures in the  $SU(n)$  vertex models can be defined similarly in the (fused) IRF models. Inspired by this observation and the identities (A13) satisfied by the transfer matrices of the  $SU(3)$  vertex model we now show that similar relations hold for the transfer matrices  $\mathbf{T}(u)$  and  $\mathbf{U}(u)$  of the inhomogeneous  $A_2^{(1)}$  IRF

models, namely:

$$\begin{aligned}
\mathbf{T}(u_k) \mathbf{T}(u_k - 1) &= \mathbf{U}(u_k), \\
\mathbf{T}(u_k) \mathbf{U}(u_k - 1) &= \Delta(u_k), \\
\mathbf{U}(u_k) \mathbf{U}(u_k - 1) &= \Delta(u_k) \mathbf{T}(u_k - 1),
\end{aligned} \tag{4.1}$$

for  $k = 1, \dots, L$ . Not all of these identities are independent: as in the vertex model each relation for given  $k$  can be obtained from the other two. Furthermore, due to the translational invariance of the model, one has e.g.

$$\prod_{k=1}^L \mathbf{T}(u_k) = \left( \prod_{k,\ell=1}^L [u_k - u_\ell + 1] \right) \mathbb{I}. \tag{4.2}$$

For the proof of these identities we make use of the properties of the Boltzmann weights introduced above adapted to the rank  $n - 1 = 2$  case: First, we note that for the case of the  $A_2^{(1)}$  model the anyon  $\psi_{[1^2]}$  corresponds to the adjoint of the vector representation. Therefore the anti-symmetrization in the fusion of Boltzmann weights effectively reverses the order of local states in the admissible pairs or, graphically,

$$\begin{array}{c} \longrightarrow \\ \longleftarrow \\ \longrightarrow \end{array} = \begin{array}{c} \longleftarrow \\ \longrightarrow \end{array}$$

This can be used to show that, upon proper normalization of the  $W_v$ , we have in particular

$$\begin{array}{c} a \qquad d \\ \left\{ \begin{array}{l} \longrightarrow \\ \longleftarrow \\ \longrightarrow \end{array} \right. \begin{array}{l} u \\ u - \frac{3}{2} \end{array} \\ g \bullet \qquad c \\ \left\{ \begin{array}{l} \longrightarrow \\ \longleftarrow \\ \longrightarrow \end{array} \right. \\ a \qquad b \end{array} = \delta_{bd} \mathcal{C}_{ab} [u + 1][u - 1][u - 2], \tag{4.3}$$

where the coefficients  $\mathcal{C}$  are given by

$$\mathcal{C}_{ab} = \begin{cases} \begin{array}{l} [1] \\ [2] \end{array} & \text{if } a \text{ is a corner state in the adjacency graph} \\ \begin{array}{l} [2] \\ [1] \end{array} & \text{if } b \text{ is a corner state in the adjacency graph} \\ 1 & \text{otherwise.} \end{cases} \tag{4.4}$$

Furthermore, since  $\sum_{k=1}^n e_n = 0$ , the definition (3.6) of the fused weights implies that, for  $n = 3$ , they satisfy the initial condition for  $u = -\frac{3}{2}$

$$W_v \left( \begin{array}{c|c} c & d \\ \hline b & a \end{array} \middle| -\frac{3}{2} \right) \sim \delta_{ac}. \tag{4.5}$$

Note that a similar relation holds for the Boltzmann weights obtained by fusing  $n - 1$  faces in the  $SU(n)_k$  anyon model.

### A. Proof of the inversion identities

The first of the inversion identities (4.1) follows trivially from the definition (3.3) and the fact that the  $k$ -th column of  $\mathbf{T}(u_k)\mathbf{T}(u_k - 1)$  reduces to the projection operator  $P_1^-$ . Using the Yang-Baxter equation (2.11) and  $(P_1^-)^2 = P_1^-$  yields the desired result.

To prove the second of the inversion identities (4.1), it is useful to employ the expression of  $\mathbf{U}$  in terms of the vertically fused weights (3.7) and exploit the inversion relation (4.3) satisfied by them. Define also  $u_{ij} = u_i - u_j$ . We have then

$$\mathbf{T}(u_k)\mathbf{U}(u_k - 1) =$$

Directly from the definitions of the elementary Boltzmann weights (2.7) and the vertically fused ones (3.6), it follows that the above expression contains a factor  $\delta_{a_k, b_{k-1}} \delta_{c_k, b_{k-1}} \sim \delta_{a_k c_k}$ . Repeated use of the inversion relation (4.3) between  $W_v$  and  $W$  then leads to

$$\begin{aligned} \mathbf{T}(u_k)\mathbf{U}(u_k - 1) &= \prod_{\ell=1}^L [u_{k\ell} + 1] [u_{k\ell} - 1] [u_{k\ell} - 2] \mathcal{C}_{c_\ell c_{\ell+1}} \\ &= \Delta(u_k) \mathbb{I}, \end{aligned} \quad (4.6)$$

where we have used the fact that, as a consequence of periodic boundary conditions for our model,

$$\prod_{\ell=1}^L \mathcal{C}_{c_\ell c_{\ell+1}} = 1. \quad (4.7)$$

Alternatively, the proof can be done using the projector operators discussed in Section II C (in fact, this form will turn out to be more convenient in order to prove the third of the inversion identities

below):

$$\mathbf{T}(u_k) \mathbf{U}(u_k - 1) =$$

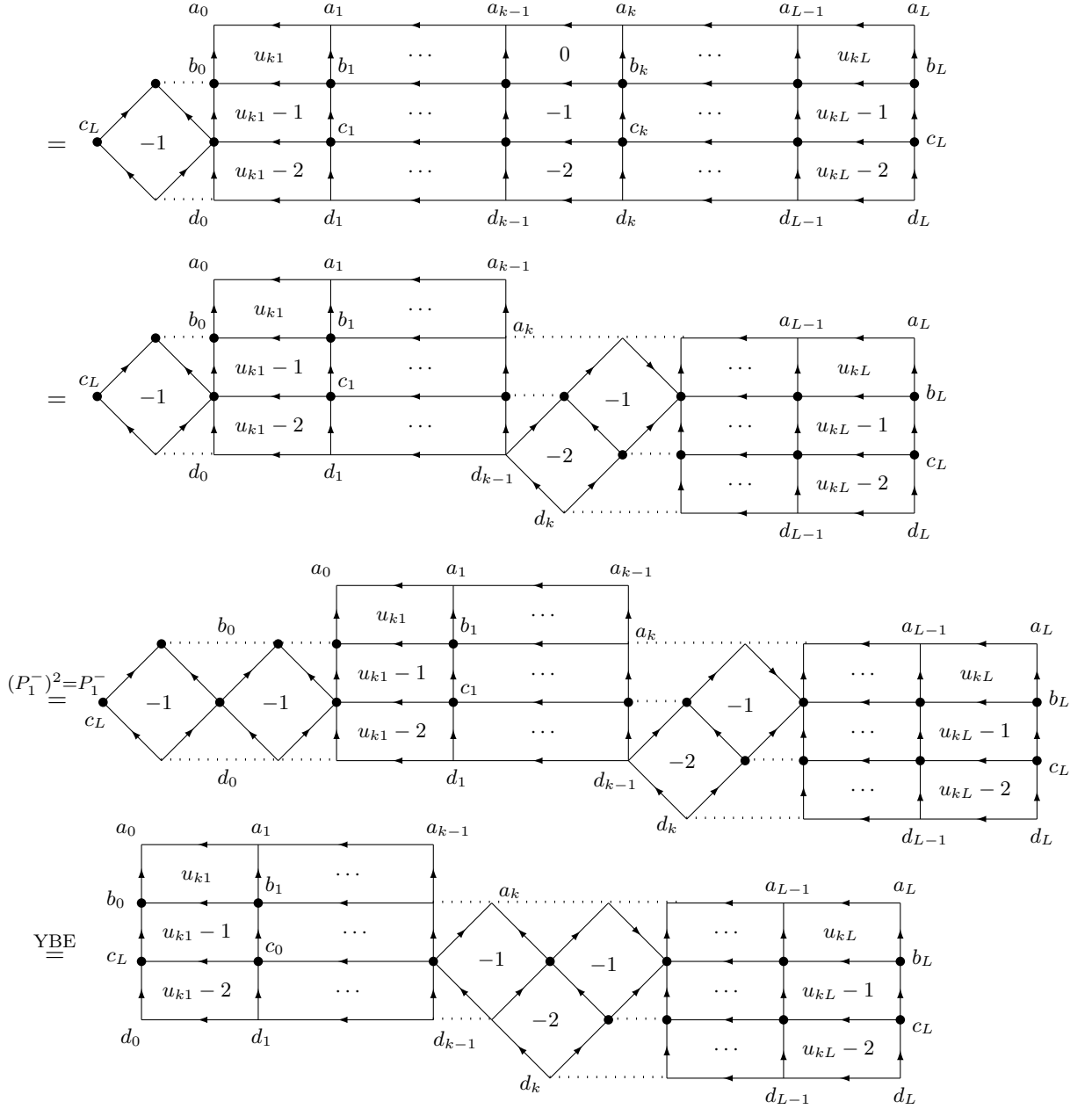

In the last step we have repetitively used the Yang-Baxter relation in order to push the left projector faces,  $P_1^-$ , to the right, and exploited once again the fact that  $(P_1^-)^2 = P_1^-$ . One immediately recognizes then the formation of the second projector operator,  $P_2^-$ , constructed in Section II C. As already noticed in that section, the action of  $P_2^-$  on a sequence  $(a_0, \dots, a_3)$  is proportional to  $\delta_{a_0 a_3}$ , the exact factor of proportionality being the one derived above through the use of the vertically fused weights.

For the third of Eqs. (4.1) we have in the same spirit

$$\mathbf{U}(u_k) \mathbf{U}(u_k - 1) =$$

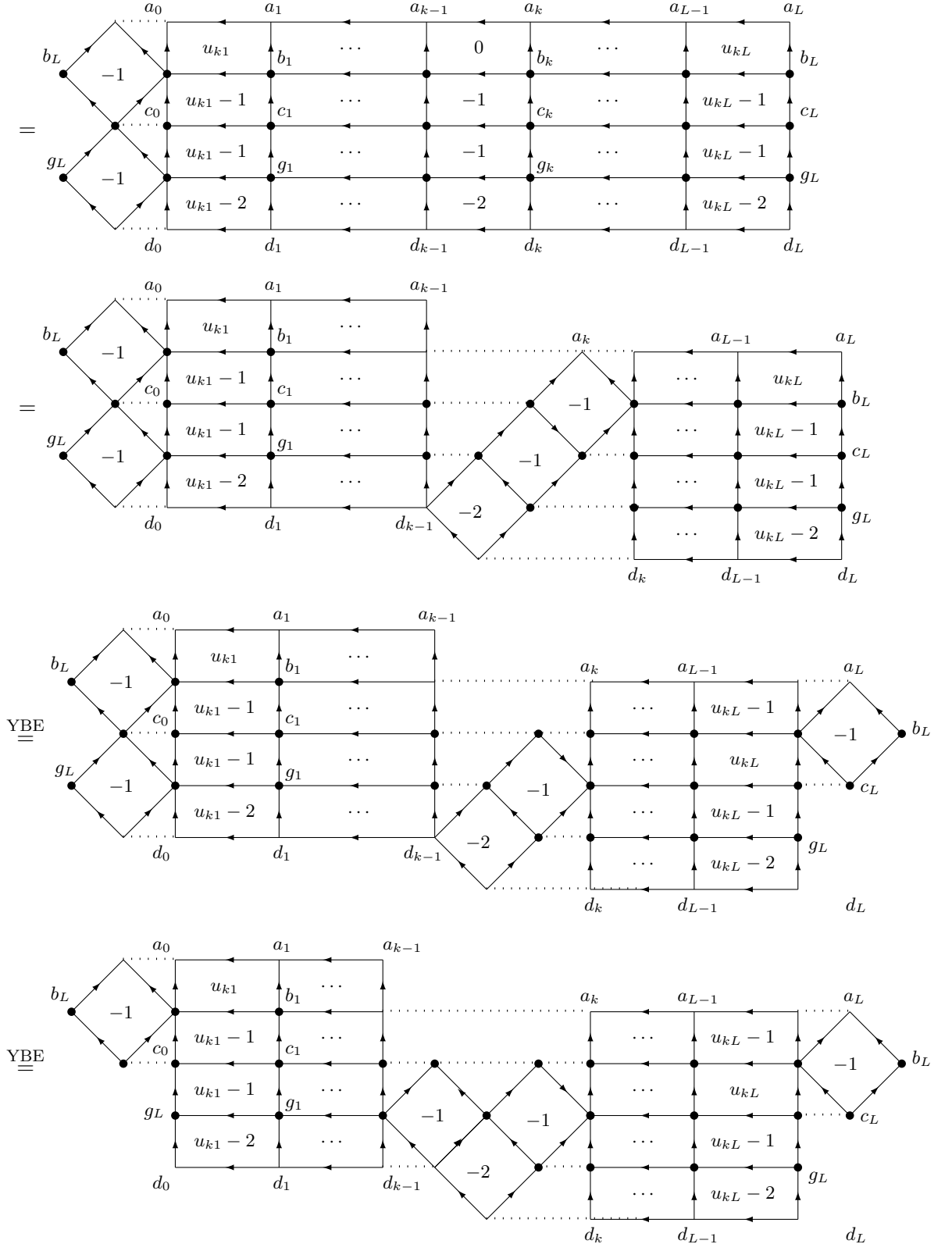





in the appendix, related identities can be derived using the quantum inverse scattering method (QISM) for the  $SU(3)$  quantum spin chain (or vertex model).

Similar identities have been obtained for the six-vertex model within Sklyanin's separation of variables solution and for the RSOS models starting from local properties of the corresponding Boltzmann weights [24, 25]. In these cases, both with underlying rank-1 quantum group, the inversion identities, when complemented by information on the analytical properties of the transfer matrix, have been found to provide a formulation of the spectral problem which allows to compute all eigenvalues. We emphasize, however, that such purely functional approach has to be complemented by an independent check that a given solution actually corresponds to an eigenvalue of the quantum chain. For the six-vertex model the latter is provided by the SoV approach.

To what extent similar results can be established for the rank  $n - 1 = 2$  models considered here remains to be studied: for the  $SU(3)$  vertex model some evidence exists from the SoV approach [31] but various open questions, e.g. concerning the actual construction of the separated variables in the fundamental spin representation (which is necessary to compute eigenstates) and the nature of their common spectrum, remain to be addressed. In addition, eigenvalues obtained within the functional approach for the vertex model can be checked, for the periodic boundary conditions considered here, against those from the algebraic Bethe ansatz [30].

For the IRF model we have some preliminary numerical results for small systems, but there remains the practical issue that identities such as (4.1) (or (A13) for the vertex model) are not well suited for an efficient computation of the transfer matrix eigenvalues. Reversing the line of arguments used to obtain the inversion identities in the appendix, however, they can be related to generalized TQ-equations such as (A11) for the  $SU(3)$  vertex model. This requires to find a factorization of (3.5) compatible with the asymptotic behaviour of the transfer matrices. Part of the additional input required to address this question for the critical IRF models is available: by definition the transfer matrices appearing in the inversion identities are Fourier polynomials in the spectral parameter. The underlying fusion algebra allows to split the spectrum into topological sectors [16] where the asymptotics of the transfer matrix can be given in terms of the eigenvalues of the adjacency matrix (2.6). As a consequence, the effect of the anyonic statistics on the spectrum of the IRF model as compared to the vertex case is similar to that of a twist in the boundary conditions (depending on the sector), in agreement with the results for the  $A_n^{(1)}$  IRF models obtained from the fusion procedure [21].

Finally let us note that – while we have concentrated in this paper on the derivation of inversion identities for the critical rank-2 IRF models with generic inhomogeneities and subject to

periodic boundary conditions – we expect that similar identities can be derived for the transfer matrices  $\mathbf{T}_\ell(u)$ ,  $\ell = 1, \dots, n-1$ , for the  $A_{n-1}^{(1)}$  IRF model and for models with open boundary conditions [42] – similar as in the case of the  $SU(n)$  vertex models [33].

We plan to address some of these questions in future work.

### ACKNOWLEDGMENTS

This work has been supported by the Deutsche Forschungsgemeinschaft under grant no. Fr 737/7.

### Appendix A: The $SU(3)$ vertex model

In this appendix we recall the structures underlying the integrability of the  $SU(3)$  invariant quantum spin chains and related two-dimensional vertex models and their Bethe ansatz solutions [30, 31, 34, 43]. The Hilbert space of the vertex models is the tensor product  $\mathcal{H} = \otimes_{j=1}^L V_j$ . To be specific we consider the case where  $V_j \simeq \mathbb{C}^3$  is the space of quantum states at site  $j$  of the lattice corresponding to the fundamental three-dimensional (vector) representation of  $SU(3)$  (corresponding to the Young diagram  $[1] = [1, 0]$ ). In the framework of the quantum inverse scattering method (QISM) we define the monodromy matrix acting on the tensor product of the auxiliary space  $V_a \simeq \mathbb{C}^3$  and the Hilbert space  $\mathcal{H}$  of the model as

$$\mathcal{T}_a(u) = \mathcal{L}_{aL}(u - u_L) \mathcal{L}_{a,L-1}(u - u_{L-1}) \cdots \mathcal{L}_{a1}(u - u_1). \quad (\text{A1})$$

Here the  $\mathcal{L}_{aj}(u)$  are operators acting non-trivially only on  $V_a \otimes V_j$ . They are given as

$$\mathcal{L}_{aj}(u) = u \mathbb{I} \otimes \mathbb{I} + \sum_{k,\ell=1}^3 e_{k\ell}^{(a)} \otimes e_{\ell k}^{(j)} \quad (\text{A2})$$

with  $3 \times 3$  matrices  $\left( e_{k\ell}^{(\alpha)} \right)_{mn} = \delta_{km} \delta_{\ell n}$  acting on  $V_\alpha$ . The complex parameters  $u_j$ ,  $j = 1, \dots, L$ , define inhomogeneities in the lattice.

The monodromy matrix (as well as the local  $\mathcal{L}$ -operators) is a representation of the Yangian  $\mathcal{Y}(su(3))$

$$R_{ab}(u - v) \mathcal{T}_a(u) \mathcal{T}_b(v) = \mathcal{T}_b(v) \mathcal{T}_a(u) R_{ab}(u - v). \quad (\text{A3})$$

The  $R$ -matrix comprises the structure constants of this algebra

$$R_{ab}(u) = u \mathbb{I} \otimes \mathbb{I} + \mathbb{P}_{ab}, \quad (\text{A4})$$

where  $\mathbb{P}_{ab}$  is the permutation operator acting on the tensor product  $\mathbb{C}^3 \otimes \mathbb{C}^3$  as  $\mathbb{P}_{ab}(x \otimes y) = y \otimes x, \forall x, y \in \mathbb{C}^3$ . As a consequence of the Yang-Baxter relations (A3) the transfer matrix

$$T(u) = \text{tr}_a[\mathcal{T}_a(u)] \quad (\text{A5})$$

forms a family of commuting operators,  $[T(u), T(v)] = 0$ . Starting from the reference state  $\otimes_{j=1}^L |0\rangle_j$ , where each spin is in the highest or lowest weight state of the local  $SU(3)$  irrep, the spectrum of the transfer matrices can be obtained by means of the nested (coordinate or) algebraic Bethe ansatz (ABA) [34, 43, 44].

An alternative solution of the spectral problem relies on functional relations between (A5) and more general  $SU(3)$  symmetric transfer matrices acting on the Hilbert space  $\mathcal{H}$  of the vertex model [30, 45]. With the projectors

$$\begin{aligned} P_{ab}^- &= \frac{1}{2}(\mathbb{I} \otimes \mathbb{I} - \mathbb{P}_{ab}) = -\frac{1}{2}R(-1) \\ P_{abc}^- &= \frac{1}{6}(\mathbb{I} \otimes \mathbb{I} \otimes \mathbb{I} + \mathbb{P}_{ab}\mathbb{P}_{bc} + \mathbb{P}_{bc}\mathbb{P}_{ab} - \mathbb{P}_{ab} - \mathbb{P}_{ac} - \mathbb{P}_{bc}), \end{aligned} \quad (\text{A6})$$

onto the antisymmetric subspaces of the product  $V_a \otimes V_b$  and  $V_a \otimes V_b \otimes V_c$ ,  $V_\alpha \simeq \mathbb{C}^3$ , respectively, we define a second transfer matrix  $U(u)$

$$U(u) = \text{tr}_{ab} [P_{ab}^- \mathcal{T}_a(u-1) \mathcal{T}_b(u)] \quad (\text{A7})$$

generated by  $\mathcal{L}$ -operators corresponding to the adjoint  $[1^2]$  of the vector representation of  $SU(3)$  in auxiliary space  $V_a \simeq \mathbb{C}^3$  and, similarly, the quantum determinant of the monodromy matrix  $\mathcal{T}(u)$ ,

$$\Delta(u) = \text{tr}_{abc} [P_{abc}^- \mathcal{T}_a(u-2) \mathcal{T}_b(u-1) \mathcal{T}_c(u)] \quad (\text{A8})$$

which generates the center of the Yangian  $\mathcal{Y}(su(3))$ . By construction  $\Delta(u)$  is a polynomial in the spectral parameter. It has  $c$ -number valued coefficients and can be factorized as

$$\Delta(u) = d_1(u-2)d_2(u-1)d_3(u)\mathbb{I}. \quad (\text{A9})$$

The polynomials  $d_j(u)$  depend on the representation of the Yangian in question. Here, i.e. for the inhomogeneous model (A1) based on the vector representation of  $SU(3)$  in all components of the quantum space, they are found to be [30]

$$d_1(u) = \prod_{j=1}^L (u - u_j) = d_2(u), \quad d_3(u) = \prod_{j=1}^L (u - u_j + 1). \quad (\text{A10})$$

The transfer matrices  $T(u)$  and  $U(u)$  generate the complete set of commuting integrals of the  $SU(3)$  spin chain. They satisfy functional equations with auxiliary operators  $Q_{1,2}(u)$  [30–32]

$$\begin{aligned}
& d_2(u-2) d_3(u-1) Q_1(u-3) - U(u-1) Q_1(u-2) \\
& \quad + d_1(u-2) T(u-1) Q_1(u-1) - d_1(u-1) d_1(u-2) Q_1(u) = 0, \\
& d_3(u-2) d_3(u-1) Q_2(u-3) - d_3(u-1) T(u-2) Q_2(u-2) \\
& \quad + U(u-1) Q_2(u-1) - d_1(u-2) d_2(u-1) Q_2(u) = 0,
\end{aligned} \tag{A11}$$

similar to Baxter’s TQ-equations for the transfer matrix of the eight-vertex model [26]. As a consequence of the commutativity of the transfer matrices and the  $Q$ -operators among each other for different arguments, analogous third order difference equations holds for their corresponding eigenvalues. Using the analytical properties of the transfer matrices these eigenvalues can be computed reproducing the result obtained from the ABA [30].

Note that the actual solution of the spectral problem for the transfer matrices by means the Bethe ansatz methods introduced so far is not possible for all integrable lattice models: the ABA relies on the existence of a suitable (highest or lowest weight) reference state which does not always exist, e.g. for models with boundary conditions breaking all possible  $U(1)$  symmetries. Similarly, the functional approach based on the TQ-equations (A11) requires a sufficiently simple (e.g. polynomial) parametrization of the eigenvalues of the  $Q$ -operators. Neither of these requirements is met, e.g., for spin chains with open boundary conditions subject to non-diagonal boundary fields. For models with  $U_q[su(2)]$ -symmetry this issue has been addressed recently using separation of variables (SoV) and through the derivation of inversion identities satisfied by the transfer matrices for certain arguments, both leading to certain generalizations of the TQ-equations [24, 28, 29, 46]. An added value of the formulation of the spectral problem within the SoV approach is that it provides a basis for the proof that the solution is complete [25, 29, 47, 48].

Application of Sklyanin’s SoV approach to integrable  $SU(3)$  models leads to equations similar to the TQ-equations but with  $Q_{1,2}$ -eigenvalues being functions on the discrete set of common eigenvalues of the separated coordinates [31]. By explicit construction for small systems we find that, similar as in the  $SU(2)$  case, this set is contained in the integer spaced lattice of  $u$ -values enclosed by the singular points of the difference equations (A11). For the model with local spins carrying the fundamental representation, i.e. (A10), the spectral parameter  $u$  takes values from  $\{u_k, u_k + 1, u_k + 2\}_{k=1}^L$ . Eliminating the corresponding amplitudes  $Q_{1,2}(u)$  one finds that

$$U(u_k + 1) = 0, \tag{A12}$$

and arrives at the following set of inversion identities for the transfer matrices

$$\begin{aligned}
 T(u_k)T(u_k - 1) &= U(u_k), \\
 T(u_k)U(u_k - 1) &= \Delta(u_k), \\
 U(u_k)U(u_k - 1) &= \Delta(u_k)T(u_k - 1),
 \end{aligned}
 \tag{A13}$$

for  $k = 1, \dots, L$ . Using the projection property (A6) of the  $R$ -matrix and the Yang-Baxter relations satisfied by the transfer matrices  $T(u)$  and  $U(u)$  these product identities have been derived before by Cao *et al.* [33] (note that the third identity can be obtained from the two other ones). These equations, together with the analytical properties of the transfer matrix are sufficient to compute their eigenvalues.

We end this appendix by noting that – while we have considered the  $SU(3)$ -invariant rational vertex model – it is straightforward to extend the discussion to the anisotropic ( $q$ -deformed) model with trigonometric dependence of the vertex weights on the spectral parameter [35, 49–51].

- 
- [1] H. Bethe, “Zur Theorie der Metalle. I. Eigenwerte und Eigenfunktionen der linearen Atomkette,” *Z. Phys.* **71**, 205–226 (1931).
  - [2] R. J. Baxter, *Exactly Solved Models in Statistical Mechanics* (Academic Press, London, 1982).
  - [3] V. E. Korepin, N. M. Bogoliubov, and A. G. Izergin, *Quantum Inverse Scattering Method and Correlation Functions* (Cambridge University Press, Cambridge, 1993).
  - [4] Fabian H. L. Essler, Holger Frahm, Frank Göhmann, Andreas Klümper, and Vladimir E. Korepin, *The One-Dimensional Hubbard Model* (Cambridge University Press, Cambridge (UK), 2005).
  - [5] Gregory Moore and Nicholas Read, “Nonabelions in the fractional quantum Hall effect,” *Nucl. Phys. B* **360**, 362–396 (1991).
  - [6] N. Read and E. Rezayi, “Beyond paired quantum Hall states: parafermions and incompressible states in the first excited Landau level,” *Phys. Rev. B* **59**, 8084–8092 (1999), cond-mat/9809384.
  - [7] Adrian Feiguin, Simon Trebst, Andreas W. W. Ludwig, Matthias Troyer, Alexei Kitaev, Zhenghan Wang, and Michael H. Freedman, “Interacting anyons in topological quantum liquids: The golden chain,” *Phys. Rev. Lett.* **98**, 160409 (2007), cond-mat/0612341.
  - [8] Charlotte Gils, Eddy Ardonne, Simon Trebst, Andreas W. W. Ludwig, Matthias Troyer, and Zhenghan Wang, “Collective States of Interacting Anyons, Edge States, and the Nucleation of Topological Liquids,” *Phys. Rev. Lett.* **103**, 070401 (2009), arXiv:0810.2277.
  - [9] Eytan Grosfeld and Kareljan Schoutens, “Non-Abelian anyons: when Ising meets Fibonacci,” *Phys. Rev. Lett.* **103**, 076803 (2009), arXiv:0810.1955.
  - [10] F. A. Bais and J. K. Slingerland, “Condensate-induced transitions between topologically ordered phases,” *Phys. Rev. B* **79**, 045316 (2009), arXiv:0808.0627.

- [11] Charlotte Gils, Eddy Ardonne, Simon Trebst, David A. Huse, Andreas W. W. Ludwig, Matthias Troyer, and Zhenghan Wang, “Anyonic quantum spin chains: Spin-1 generalizations and topological stability,” *Phys. Rev. B* **87**, 235120 (2013), arXiv:1303.4290.
- [12] Peter E. Finch, Holger Frahm, Marius Lewerenz, Ashley Milsted, and Tobias J. Osborne, “Quantum phases of a chain of strongly interacting anyons,” *Phys. Rev. B* **90**, 081111(R) (2014), arXiv:1404.2439.
- [13] G. E. Andrews, R. J. Baxter, and P. J. Forrester, “Eight-vertex SOS model and generalized Rogers-Ramanujan-type identities,” *J. Stat. Phys.* **35**, 193–266 (1984).
- [14] V. Pasquier, “Etiology of IRF models,” *Comm. Math. Phys.* **118**, 355–364 (1988).
- [15] Michio Jimbo, Tetsuji Miwa, and Masato Okado, “Local state probabilities of solvable lattice models: An  $A_{n-1}^{(1)}$  family,” *Nucl. Phys. B* **300**, 74–108 (1988).
- [16] P. di Francesco and J.-B. Zuber, “SU(N) lattice integrable models associated with graphs,” *Nucl. Phys. B* **338**, 602–646 (1990).
- [17] Doron Gepner, *Foundations of Rational Quantum Field Theory, I*, Preprint CALT-68-1825 (Caltech, 1992) hep-th/9211100.
- [18] Peter E. Finch and Holger Frahm, “The  $D(D_3)$ -anyon chain: integrable boundary conditions and excitation spectra,” *New J. Phys.* **15**, 053035 (2013), arXiv:1211.4449.
- [19] Peter E. Finch, Michael Flohr, and Holger Frahm, “Integrable anyon chains: from fusion rules to face models to effective field theories,” *Nucl. Phys. B* **889**, 299–332 (2014), arXiv:1408.1282.
- [20] M. Jimbo, A. Kuniba, T. Miwa, and M. Okado, “The  $A_n^{(1)}$  Face Models,” *Comm. Math. Phys.* **119**, 543–565 (1988).
- [21] V. V. Bazhanov and N. Reshetikhin, “Restricted solid-on-solid models connected with simply laced algebras and conformal field theory,” *J. Phys. A* **23**, 1477–1492 (1990).
- [22] Yu-kui Zhou and Paul Pearce, “Solution of functional equations of restricted  $A_{n-1}^{(1)}$  fused lattice models,” *Nucl. Phys. B* **446**, 485–510 (1995), hep-th/9502067.
- [23] Junpeng Cao, Wen-Li Yang, Kangjie Shi, and Yupeng Wang, “Off-diagonal Bethe ansatz solutions of the anisotropic spin-1/2 chains with arbitrary boundary fields,” *Nucl. Phys. B* **877**, 152–175 (2013), arXiv:1307.2023.
- [24] Holger Frahm and Nikos Karaiskos, “Inversion identities for inhomogeneous face models,” *Nucl. Phys. B* **887**, 423–440 (2014), arXiv:1407.6883.
- [25] E. K. Sklyanin, “Quantum Inverse Scattering Method. Selected Topics,” in *Quantum Group and Quantum Integrable Systems*, Nankai Lectures in Mathematical Physics, edited by Mo-Lin Ge (World Scientific, Singapore, 1992) pp. 63–97, hep-th/9211111.
- [26] Rodney J. Baxter, “Partition function of the Eight-Vertex lattice model,” *Ann. Phys.* **70**, 193–228 (1972).
- [27] Junpeng Cao, Wen-Li Yang, Kangjie Shi, and Yupeng Wang, “Off-diagonal Bethe ansatz and exact solution of a topological spin ring,” *Phys. Rev. Lett.* **111**, 137201 (2013), arXiv:1305.7328.
- [28] Junpeng Cao, Wen-Li Yang, Kangjie Shi, and Yupeng Wang, “Off-diagonal Bethe ansatz solution

- of the XXX spin-chain with arbitrary boundary conditions,” Nucl. Phys. B **875**, 152–165 (2013), arXiv:1306.1742.
- [29] N. Kitanine, J. M. Maillet, and G. Niccoli, “Open spin chains with generic integrable boundaries: Baxter equation and Bethe ansatz completeness from SOV,” J. Stat. Mech. , P05015 (2014), arXiv:1401.4901.
- [30] P. P. Kulish and N. Yu. Reshetikhin, “ $GL_3$ -invariant solutions of the Yang–Baxter equation and associated quantum systems,” J. Sov. Math. **34**, 1948–1971 (1986), [Zap. Nauch. Semin. LOMI **120**, 92-121 (1982)].
- [31] E. K. Sklyanin, “Separation of variables in the quantum integrable models related to the Yangian  $\mathcal{Y}[sl(3)]$ ,” J. Math. Sci. **80**, 1861–1871 (1996), [Zap. Nauch. Sem. LOMI **205** (1993) 166-178], hep-th/9212076.
- [32] G. P. Pronko and Yu. G. Stroganov, “Families of solutions of the nested Bethe ansatz for the  $A_2$  spin chain,” J. Phys. A **33**, 8267–8273 (2000).
- [33] Junpeng Cao, Wen-Li Yang, Kangjie Shi, and Yupeng Wang, “Nested off-diagonal Bethe ansatz and exact solutions of the  $su(n)$  spin chain with generic integrable boundaries,” JHEP04 , 143 (2014), arXiv:1312.4770.
- [34] P. P. Kulish and N. Yu. Reshetikhin, “Diagonalisation of  $GL(N)$  invariant transfer matrices and quantum  $N$ -wave system (Lee model),” J. Phys. A **16**, L591–L596 (1983).
- [35] Michio Jimbo, “A  $q$ -analogue of  $U(\mathfrak{g}[(N + 1)])$ , Hecke algebra, and the Yang-Baxter equation,” Lett. Math. Phys. **11**, 247–252 (1986).
- [36] V. Pasquier, “Continuum limit of lattice models built on quantum groups,” Nucl. Phys. B **295**, 491–510 (1988).
- [37] Y. Asai, M. Jimbo, T. Miwa, and Y. Pugai, “Bosonization of vertex operators for the  $A_{n-1}^{(1)}$  face model,” J. Phys. A **29**, 6595–6616 (1996), hep-th/9606095.
- [38] Rodney Baxter, “Eight-Vertex Model in Lattice Statistics and One-Dimensional Anisotropic Heisenberg Chain. I. Some Fundamental Eigenvectors,” Ann. Phys. (NY) **76**, 1–24 (1973).
- [39] Rodney Baxter, “Eight-Vertex Model in Lattice Statistics and One-Dimensional Anisotropic Heisenberg Chain. II. Equivalence to a Generalized Ice-type Lattice Model,” Ann. Phys. (NY) **76**, 25–47 (1973).
- [40] Rodney Baxter, “Eight-Vertex Model in Lattice Statistics and One-Dimensional Anisotropic Heisenberg Chain. III. Eigenvectors of the Transfer Matrix and Hamiltonian,” Ann. Phys. (NY) **76**, 48–71 (1973).
- [41] Peter E. Finch, “From spin to anyon notation: The XXZ Heisenberg model as a  $D_3$  (or  $su(2)_4$ ) anyon chain,” J. Phys. A **46**, 055305 (2013), arXiv:1201.4470.
- [42] M. T. Batchelor, V. Fridkin, A. Kuniba, and Y. K. Zhou, “Solutions of the reflection equation for face and vertex models associated with  $A_n^{(1)}, B_n^{(1)}, C_n^{(1)}, D_n^{(1)}$  and  $A_n^{(2)}$ ,” Phys. Lett. B **376**, 266–274 (1996), hep-th/9601051.
- [43] Bill Sutherland, “Model for a multicomponent quantum system,” Phys. Rev. B **12**, 3795–3805 (1975).
- [44] C. N. Yang, “Some exact results for the many-body problem in one dimension with repulsive delta-



- function interaction,” *Phys. Rev. Lett.* **19**, 1312–1315 (1967).
- [45] P. P. Kulish, N. Yu. Reshetikhin, and E. K. Sklyanin, “Yang-Baxter equation and representation theory: I,” *Lett. Math. Phys.* **5**, 393–403 (1981).
- [46] G. Niccoli, “Non-diagonal open spin-1/2 XXZ quantum chains by separation of variables: complete spectrum and matrix elements of some quasi-local operators,” *J. Stat. Mech.* , P10025 (2012), arXiv:1206.0646.
- [47] H. Frahm, A. Seel, and T. Wirth, “Separation of Variables in the open XXX chain,” *Nucl. Phys. B* **802**, 351–367 (2008), arXiv:0803.1776.
- [48] S. Faldella, N. Kitanine, and G. Niccoli, “The complete spectrum and scalar products for the open spin-1/2 XXZ quantum chains with non-diagonal boundary terms,” *J. Stat. Mech.* , P01011 (2014), arXiv:1307.3960.
- [49] A. A. Belavin, “Dynamical symmetry of integrable quantum systems,” *Nucl. Phys. B* **180**, 189–200 (1981).
- [50] O. Babelon, H. J. de Vega, and C. M. Viallet, “Solutions of the factorization equations from Toda field theory,” *Nucl. Phys. B* **190**, 542–552 (1981).
- [51] Jacques H. H. Perk and Cherie L. Schultz, “New families of commuting transfer matrices in  $q$ -state vertex models,” *Phys. Lett. A* **84**, 407–410 (1981).