

# DIAGRAM CATEGORIES FOR $U_q$ -TILTING MODULES AT ROOTS OF UNITY

HENNING HAAHR ANDERSEN AND DANIEL TUBBENHAUER

ABSTRACT. We give a diagrammatic presentation of the category of  $U_q(\mathfrak{sl}_2)$ -tilting modules  $\mathfrak{T}$  for  $q$  being a root of unity and introduce a grading on  $\mathfrak{T}$ . This grading is a “root of unity phenomenon” and might lead to new insights about link and 3-manifold invariants deduced from  $\mathfrak{T}$ . We also give a diagrammatic category for the (graded) projective endofunctors on  $\mathfrak{T}$ , indicate how our results could generalize and collect some “well-known” facts to give a reasonably self-contained exposition.

## CONTENTS

1. Introduction	1
1.1. The framework	1
1.2. An outline of the paper	5
2. The tilting category $\mathfrak{T}$	5
2.1. Quantum groups at roots of unity	5
2.2. Weyl modules, dual Weyl modules and simple modules	6
2.3. Tilting modules and the tilting category $\mathfrak{T}$	8
2.4. The linkage principle and blocks	10
2.5. Translation functors	14
3. The Khovanov-Seidel quiver algebra and gradings	17
3.1. The quiver algebras $Q_m$ and $Q_\infty$	17
3.2. Combinatorics of the graded, right $Q_m$ - and $Q_\infty$ -modules	19
3.3. Endofunctors on $p\text{Mod}_{\text{gr}}\text{-}Q_m$ and $p\text{Mod}_{\text{gr}}\text{-}Q_\infty$	20
3.4. $Q_\infty$ and the tilting category $\mathfrak{T}$	22
3.5. The tilting category $\mathfrak{T}$ and its graded counterpart $\mathfrak{T}^{\text{gr}}$	27
4. Diagrams for the graded tilting category $\mathfrak{T}^{\text{gr}}$	31
4.1. The basics: diagrammatic categories, additive closures and Karoubi envelopes	31
4.2. The dihedral cathedral $\mathfrak{D}(\infty)$	32
4.3. The quotient $\mathfrak{QD}(\infty)$	37
4.4. $\mathfrak{QD}(\infty)$ and the tilting category $\mathfrak{T}^{\text{gr}}$	41
4.5. Diagram categories for $p\text{End}(\mathfrak{T}_\lambda^{\text{gr}})$	46
References	48

## 1. INTRODUCTION

1.1. **The framework.** In this paper we study the quantum group  $U_q = U_q(\mathfrak{sl}_2)$ , where  $q$  is a root of unity, its category of tilting modules  $\mathfrak{T}$  and the category of projective endofunctors  $p\text{End}(\mathfrak{T})$  combinatorially and diagrammatically.

---

The authors were partially supported by the center of excellence grant “Centre for Quantum Geometry of Moduli Spaces (QGM)” from the “Danish National Research Foundation (DNRF)”.

Everything we do is completely explicit and “down to earth”, but motivated and deduced from a general machinery that comes, from the side of representation theory, from pioneering work of Soergel [53], Beilinson-Ginzburg-Soergel [7], Kazhdan-Lusztig [29] and Stroppel [57], and from the side of combinatorics and diagrammatics, from work of Soergel [55], Khovanov-Lauda [33] and Elias-Khovanov [19].

Let us motivate and explain our approach.

1.1.1. *Quantum groups at roots of unity: non-semisimplicity, modular representation theory and affine Weyl groups.* Fix a simple complex Lie algebra  $\mathfrak{g}$ . Then the finite-dimensional<sup>1</sup> representation theory of the quantum deformation  $U_v(\mathfrak{g})$  of  $U(\mathfrak{g})$  is, for *generic* parameter  $v$ , semisimple and very similar to the classical representation theory for  $U(\mathfrak{g})$ .

This drastically changes when specializing  $v$  to an  $l$ -th (we allow any  $l > 2$  throughout the paper) root of unity  $q$ : the representation theory of  $U_q(\mathfrak{g})$  is non-semisimple. This is mostly due to the fact that the so-called Weyl modules at roots of unity are, in general, *not simple* and filtrations by Weyl modules *do not necessarily split*. A lot of questions remain open about the representation theory at roots of unity. In fact, the representation theory of  $U_q(\mathfrak{g})$  over  $\mathbb{C}$  has many similarities to the representation theory of a corresponding almost simple, simply connected algebraic group  $G$  over an algebraically closed field  $K$  of prime characteristic, see for example [3] or [40].

It turns out, when studying the representation theory of  $U_q(\mathfrak{g})$ , a certain category of *tilting modules*  $\mathfrak{T}$  comes up naturally. The category  $\mathfrak{T}$  is inspired by the corresponding category of tilting modules for reductive algebraic groups due to Donkin [17] (see also Ringel [49]) and shares most of its properties, see for example [1]. It is our main object under study in this paper.

Note that the “combinatorics” (the irreducible characters) of  $G$  and  $U_q(\mathfrak{g})$  was conjectured by Lusztig (see [42] for  $G$  and [40] for  $U_q(\mathfrak{g})$ ) to be related to values at 1 of the Kazhdan-Lusztig polynomial associated to the *affine* Weyl group for  $\mathfrak{g}$ . In addition, Kazhdan and Lusztig proved later that the category of finite-dimensional  $U_q(\mathfrak{g})$ -modules (of type 1) is equivalent to a category of modules for the corresponding affine Kac-Moody algebra, see [29].

This combined with the solution of Kashiwara and Tanisaki [28] of the Kazhdan-Lusztig conjecture in the affine Kac-Moody case then solved the above mentioned conjecture for the irreducible characters of  $U_q(\mathfrak{g})$ . Even closer related to our work: Soergel first conjectured in [54] and later proved in [52] a corresponding statement about indecomposable tilting modules. In our little  $\mathfrak{sl}_2$  case we do not need these deep results because we can work out both, the irreducible characters and the indecomposable tilting modules, “*by hand*”.

1.1.2. *Categorification and graded categories.* A ground-breaking development towards giving an *algebraic* proof of the Kazhdan-Lusztig conjectures was initiated by Soergel in [55]. He defines a combinatorial category  $\mathcal{S}$  consisting of objects that are bimodules over a polynomial ring  $R$ . These bimodules are nowadays commonly called Soergel bimodules and are indecomposable direct summands of tensor products of certain algebraically/combinatorially defined  $R$ -bimodules.

His category is additive, monoidal and graded and he proves that its Grothendieck group  $K_0$  is isomorphic to an integral form of the Hecke algebra  $H_v(W)$  associated to the Weyl group  $W$  of the simple Lie algebra  $\mathfrak{g}$  in question. Here the grading and the corresponding shifting functors give on the level of Grothendieck groups rise to the indeterminate  $v$  of  $H_v(W)$ . Thus, we can say that

---

<sup>1</sup>If not otherwise stated: modules in this paper are assumed to be finite-dimensional. There are only few exceptions in this paper, e.g.  $T_q(\infty)$  from Definition 2.25. We hope it is clear from the context.

Soergel’s has *categorified*  $H_v(W)$  (actually, the categorification works for any Coxeter group  $W$  and its associated Hecke algebra  $H_v(W)$ ).

In fact, in the spirit of categorification outlined by Crane and Frenkel in the mid-nineties, *graded* categories  $\mathcal{C}$  (or *graded 2-categories*) give rise to a structure of a  $\mathbb{Z}[v, v^{-1}]$ -module on  $K_0(\mathcal{C})$  (where “shifting decategorifies” to multiplication by  $v$ ). Many examples of this kind of categorification are known. For example, Khovanov’s categorification of the Jones polynomial (sometimes also called  $\mathfrak{sl}_2$ -polynomial) [30], Khovanov-Rozansky’s categorification of the  $\mathfrak{sl}_n$ -polynomial in [35] (all of these, although originally defined differently, can be obtained using 2-functors on graded 2-categories), or Khovanov-Lauda and Rouquier’s categorification of  $U_v(\mathfrak{g})$  and its highest weight modules, see for example [33] and [50] using the so-called Khovanov-Lauda Rouquier algebra, are among the more popular ones and have opened new directions of research.

Thus, it is natural to ask if we can introduce a *non-trivial grading* on  $\mathfrak{T}$  as well. We do this in Section 3 by using an argument pioneered by Soergel (see [53]) in the ungraded and Stroppel (see [57]) in the graded case for category  $\mathcal{O}$ . Namely, the usage of Soergel’s combinatorial functor  $\mathbb{V}$  that gives rise to an equivalence of a block of  $\mathcal{O}$  (for  $\mathfrak{g}$ ) and a certain full subcategory of  $\text{Mod-}A$ . The algebra  $A$  is the endomorphism ring of the *anti-dominant projective* in the block and it can be explicitly (when the block is regular) identified with the algebra of coinvariants for the Weyl group associated to  $\mathfrak{g}$ . This algebra can be given a  $\mathbb{Z}$ -grading and, as Stroppel explains in [57], this set-up gives rise to *graded* versions of blocks of category  $\mathcal{O}$  and the categories of *graded* endofunctors on these blocks. In fact, as Stroppel explains in [57], her approach is a combinatorial alternative to the approach of Beilinson, Ginzburg and Soergel given in [7].

As in the other cases above, the *grading* is the crucial point: in category  $\mathcal{O}$  the multiplicity  $[\Delta_q(\lambda) : L_q(\mu)]$  of the simple module  $L_q(\mu)$  inside of the Verma  $\Delta_q(\lambda)$  is given by evaluating the corresponding Kazhdan-Lusztig polynomial at 1. The Kazhdan-Lusztig polynomial is a polynomial and not just a number and the grading of  $\mathcal{O}$  “explains” now the *individual coefficients* of these polynomials as well.

In our case the role of  $A$  is, as we explain in Section 3, played by an “infinite version”  $Q_\infty$  of a quiver algebra  $Q_m$  that Khovanov and Seidel introduced in [36] in their study of Floer homology<sup>2</sup>. Its “Koszul version” appears in various contexts related to symplectic topology, algebraic geometry and representation theory. In particular, it appears as a subquotient of Khovanov’s arc algebra that he introduced in [31] to give an algebraic structure underlying Khovanov homology and whose representation theory is known to be highly interesting as outlined in a series of papers by Brundan and Stroppel, see [12], [13], [14], [15] and [11]. The grading can be seen as coming from the corresponding grading of some Khovanov-Lauda Rouquier algebra and we use it to introduce the grading on  $\mathfrak{T}$  (for each block  $\mathfrak{T}_\lambda$ ) and we obtain a graded category  $\mathfrak{T}^{\text{gr}}$ .

We stress that this grading is a “*root of unity phenomenon*”: the category of finite-dimensional  $U_v$ -modules is semisimple and has therefore no interesting grading. On the other hand, the grading on  $\mathfrak{T}^{\text{gr}}$  is non-trivial and gives for example rise (as mentioned above) to a grading for similar modules of reductive algebraic groups over algebraical closed fields  $K$  of prime characteristic.

Thus, an intriguing question is if one can use the grading on  $\mathfrak{T}^{\text{gr}}$  to obtain new information about link invariants or about the Witten-Reshetikhin-Turaev invariants of 3-manifolds that can be deduced from  $\mathfrak{T}$ , see [1] or [61]. Note that, as we deduce in Remark 3.29, each block  $\mathfrak{T}_\lambda^{\text{gr}}$  of  $\mathfrak{T}^{\text{gr}}$

---

<sup>2</sup>Around the same time this quiver algebra was considered independently by Braden in [10]. We stay with Khovanov and Seidel’s formulation (but write  $Q_m$  instead of  $A_m$  as they do) because the functors they considered on the category of representations of this algebra are closely connected to translation functors in our context.

deategorifies to the Burau representation of the braid group  $B_\infty$  with  $\infty$ -many strands (the split Grothendieck group  $K_0^\oplus$  carries an action of  $B_\infty$ ), which already gives a hint how these topological invariants could be related to our work.

1.1.3. *Diagram categories, biadjoint functors and diagrammatic categorification.* Khovanov and Lauda have categorified  $\mathbb{U}_v(\mathfrak{sl}_k)$ , see [33]. Their approach, that has turned out to be very fruitful, was to use *diagrammatic categorification*: they defined a certain 2-category  $\mathcal{U}(\mathfrak{sl}_k)$  consisting of a certain type of so-called string diagrams whose (split) Grothendieck group  $K_0^\oplus(\mathcal{U}(\mathfrak{sl}_k))$  gives the idempotent, integral form  $\dot{\mathbb{U}}_v(\mathfrak{sl}_k)_\mathbb{Z}$  of  $\mathbb{U}_v(\mathfrak{sl}_k)$ . One of their main observations was that the  $E$ 's and  $F$ 's of  $\dot{\mathbb{U}}_v(\mathfrak{sl}_k)_\mathbb{Z}$  behave like biadjoint induction and restriction functors on certain categories. As outlined in an even more general framework by Khovanov in [32] (although it was folklore knowledge for some years and appears in a more rigorous form in for example [27] or [46]), biadjoint functors have a “*built-in topology*” since, roughly, biadjointness means that we can straighten out diagrams.

Let us denote by  $B_i$  the bimodules from Soergel’s categorification of the Hecke algebra  $H_v(W)$  from above. A main feature of the  $B_i$ ’s is that tensoring with  $B_i$  is a self-adjoint endofunctor and, even stronger, a *Frobenius object*, i.e. there are morphisms

$$B_i \rightarrow R, \quad R \rightarrow B_i, \quad B_i \rightarrow B_i \otimes_R B_i \quad \text{and} \quad B_i \otimes_R B_i \rightarrow B_i$$

pictured as (we read from bottom to top and right to left)

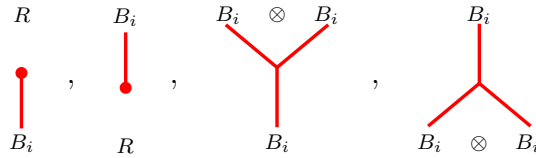

that satisfy the *Frobenius relations* (plus reflections of these)

$$\mathbf{Frob1} : \begin{array}{c} \diagup \quad \diagdown \\ | \\ \diagdown \quad \diagup \end{array} = \begin{array}{c} \diagdown \quad \diagup \\ | \\ \diagup \quad \diagdown \end{array}, \quad \mathbf{Frob2} : \begin{array}{c} \bullet \\ \diagdown \quad \diagup \\ | \\ \bullet \end{array} = | = \begin{array}{c} \diagdown \quad \diagup \\ | \\ \bullet \end{array}$$

It is tempting to ask if one can give a *diagrammatic categorification* in the spirit of  $\mathbb{U}_v(\mathfrak{sl}_n)$ -string diagrams of Khovanov-Lauda (see [33]) for Soergel’s categorification as well. The observations from above, as Khovanov explains in [32, Section 3], were the main reason why Elias and Khovanov started to look for such a description.

They were (very) successful in their search and their diagrammatic categorification given in [19] (in fact, the diagrams above are the ones they use) has inspired many successive works. Most mentionable for this paper: Elias’ categorification  $\mathfrak{D}(\infty)$  of the Hecke algebra  $H_v(D_\infty)$  (where  $D_\infty$  is the infinite dihedral group) from [18] called the *dihedral cathedral* or, alternatively, the presentation in terms of generators and relations of the same category given by Libedinsky [39].

This has already led to seminal results: as Elias and Williamson explain in [23, Subsection 1.3], their algebraic proof that the Kazhdan-Lusztig polynomials have positive coefficients for *arbitrary* Coxeter systems was discovered using the diagrammatic framework from [21] and [22].

In our context: the combinatorics of the blocks  $\mathfrak{T}_\lambda$ , as explained in Subsection 2.5, is mostly governed by two functors  $\Theta_s$  and  $\Theta_t$  called translation through the  $s$  and  $t$ -wall respectively. Here  $s$  and  $t$  are the two reflections that generate the *affine* Weyl group  $W_1 \cong D_\infty$  of  $\mathfrak{sl}_2$ . These functors, motivated from the category  $\mathcal{O}$  analogs, are *biadjoint* and satisfy *Frobenius relations*. Moreover, we show in Lemma 3.8 and Theorem 3.12 that this *still holds* in the graded setting. Thus, it seems

reasonable to expect that  $\mathfrak{T}_\lambda^{\text{gr}}$  and its category of (graded) projective endofunctors  $p\text{End}(\mathfrak{T}_\lambda^{\text{gr}})$  have a *diagrammatic* description as well. And, since  $W_l \cong D_\infty$ , it seems reasonable to expect a relation to Elias’ *dihedral cathedral*  $\mathfrak{D}(\infty)$  from [18]. We prove this in Section 4 by introducing certain quotients of  $\mathfrak{D}(\infty)$  giving rise to a diagrammatic presentation of  $\mathfrak{T}_\lambda^{\text{gr}}$  and  $p\text{End}(\mathfrak{T}_\lambda^{\text{gr}})$ .

**1.2. An outline of the paper.** The paper is organized as follows.

- Section 2 contains the definition and some basic properties of the category of  $U_q$ -tilting modules  $\mathfrak{T}$  as well as the category of projective endofunctors of it. Most of Section 2 is known, but we have included some new observations.
- In Section 3 we recall Khovanov-Seidel’s  $m$ -quiver algebra  $Q_m$  and introduce the “infinite version”  $Q_\infty$ . We show that the regular blocks of  $\mathfrak{T}$  embed into the module category of  $Q_\infty$ . Since  $Q_\infty$  is naturally graded, we thus, define blockwise a grading on  $\mathfrak{T}$  and  $p\text{End}(\mathfrak{T}_\lambda)$ .
- Section 4 finally provides the diagrammatic interpretation of the results from before. That is, we introduce a diagram category  $\mathfrak{QD}(\infty)$  which is a quotient of the diagram category studied by Elias [18] and show that the additive closure of  $\mathfrak{QD}(\infty)$  and  $\mathfrak{T}_\lambda^{\text{gr}}$  are equivalent as graded categories. Similarly, we enrich  $\mathfrak{QD}(\infty)$  and obtain a diagrammatic description of the (graded) category of endofunctors as well.

Everything is very explicit and we try to illustrate this with examples along the way.

**Remark 1.1.** We use colors in this paper. Some of them are not important and only for illustration. But in Section 4 we need red and green and it is crucial that they are different. The reader who has a black-and-white version can distinguish these since green appears lightly shaded.  $\blacktriangle$

**Acknowledgements:** We thank Christian Blanchet, Ben Elias, Gregor Masbaum, Catharina Stroppel, Pedro Vaz and Geordie Williamson for many helpful discussions. Special thanks to Geordie Williamson for pointing out a connection of the tilting category to an anti-spherical quotient of Elias’ dihedral cathedral. We are also grateful to the anonymous referees for many careful comments and corrections. D.T. thanks the Danish summer for, positively formulated, not distracting him from typing this paper.

## 2. THE TILTING CATEGORY $\mathfrak{T}$

In this section we describe the category  $\mathfrak{T}$  of  $U_q = U_q(\mathfrak{sl}_2)$ -tilting modules for the quantum enveloping algebra<sup>3</sup> of  $\mathfrak{sl}_2$  at a fixed root of unity  $q$ . We give a hopefully self-contained summary of the results in the  $\mathfrak{sl}_2$  case since most results are either spread out over the literature or only mentioned implicitly. But we have also included some new observations related to our context.

We mostly follow [25, Chapters 1, 2, 3] with our notation,  $v$  denotes an indeterminate,  $q \in \mathbb{Q}(q)$  denotes a fixed root of unity and all module categories in this section are categories of *left* modules.

**2.1. Quantum groups at roots of unity.** Before we start, let us fix some notions. Given  $a \in \mathbb{Z}$  and  $b \in \mathbb{Z}_{\geq 0}$ , let

$$[a] = \frac{v^a - v^{-a}}{v - v^{-1}} = v^{a-1} + v^{a-3} + \dots + v^{-a+1} + v^{-a+1}, \quad [b]! = [1][2] \cdots [b-1][b],$$

$$\begin{bmatrix} a \\ b \end{bmatrix} = \frac{[a][a-1] \cdots [a-b+2][a-b+1]}{[b]!} \in \mathbb{Z}[v, v^{-1}].$$

be the *quantum integer*, the *quantum factorial* and the *quantum binomial*. By convention,  $[0]! = 1$ .

---

<sup>3</sup>We like to work over the cyclotomic field  $\mathbb{Q}(q)$ , but any field of characteristic zero containing  $q$  would work.

**Definition 2.1.** The *quantum special linear algebra*  $\mathbf{U}_v(\mathfrak{sl}_2)$  is the associative, unital  $\mathbb{Q}(v)$ -algebra generated by  $K, K^{-1}, E$  and  $F$  subject to the relations

$$KK^{-1} = K^{-1}K = 1, \quad KE = v^2EK, \quad KF = v^{-2}FK, \quad EF - FE = \frac{K - K^{-1}}{v - v^{-1}}.$$

We write  $\mathbf{U}_v = \mathbf{U}_v(\mathfrak{sl}_2)$  for short. ▲

Recall that  $\mathbf{U}_v$  is a Hopf algebra with coproduct  $\Delta$ , antipode  $S$  and the counit  $\varepsilon$  given by

$$\begin{aligned} \Delta(E) &= E \otimes 1 + K \otimes E, & \Delta(F) &= F \otimes K^{-1} + 1 \otimes F, & \Delta(K) &= K \otimes K, \\ S(E) &= -K^{-1}E, & S(F) &= -FK, & S(K) &= K^{-1}, & \varepsilon(E) &= \varepsilon(F) = 0, & \varepsilon(K) &= 1. \end{aligned}$$

This allows to extend actions to tensor products and to duals, and there is a trivial  $\mathbf{U}_v$ -module.

We want to “specialize” the  $v$  to be a root of unity  $q \in \mathbb{Q}(q)$ . To this end, let  $\mathbf{A} = \mathbb{Z}[v, v^{-1}]$  and we consider Lusztig’s  $\mathbf{A}$ -form  $\mathbf{U}_{\mathbf{A}}$  from [41].

**Definition 2.2. (Lusztig’s  $\mathbf{A}$ -form  $\mathbf{U}_{\mathbf{A}}$ )** Define for  $j \in \mathbb{Z}_{>0}$  the  $j$ -th divided powers

$$E^{(j)} = \frac{E^j}{[j]!}, \quad F^{(j)} = \frac{F^j}{[j]}.$$

$\mathbf{U}_{\mathbf{A}}$  is defined as the  $\mathbf{A}$ -subalgebra of  $\mathbf{U}_v$  generated by  $K, K^{-1}, E^{(j)}$  and  $F^{(j)}$ . ▲

**Definition 2.3.** Fix a root of unity  $q \in \mathbb{Q}(q)$ ,  $q \neq \pm 1$  and denote by  $l$  the order<sup>4</sup> of  $q^2$ . Consider  $\mathbb{Q}(q)$  as an  $\mathbf{A}$ -module by specializing  $v$  to  $q$ . Define

$$\mathbf{U}_q = \mathbf{U}_{\mathbf{A}} \otimes_{\mathbf{A}} \mathbb{Q}(q).$$

We abuse notation and write  $E^{(j)}$  instead of  $E^{(j)} \otimes 1$ . Analogously for the other generators. ▲

**Remark 2.4.** It is easy to check that  $\mathbf{U}_{\mathbf{A}}$  is a Hopf subalgebra of  $\mathbf{U}_v$ . Thus,  $\mathbf{U}_q$  inherits a Hopf algebra structure from  $\mathbf{U}_v$ . In particular, if one has a  $\mathbf{U}_q$ -module  $M$ , then  $M^* = \text{Hom}_{\mathbf{U}_q}(M, \mathbb{Q}(q))$  has the usual induced action. It follows that, if  $m \in M$  is an eigenvector of  $K$  with eigenvalue  $\alpha$  and  $m^* \in M^*$  a dual vector with respect to some  $K$ -stable complement of  $\mathbb{Q}(q)m$  in  $M$ , then

$$(1) \quad Km = \alpha m \iff Km^* = \alpha^{-1}m^*.$$

Moreover, note that  $[j] = 0 \in \mathbf{U}_q$  iff  $l|j$ . This implies  $E^l = [l]!E^{(l)} = 0$  and  $F^l = [l]!F^{(l)} = 0$ . It is also true that  $K^{2l} = 1$ , see [40, Lemma 4.4 (a)]. ▲

## 2.2. Weyl modules, dual Weyl modules and simple modules.

**Definition 2.5. (Weyl, dual Weyl and simple modules)** Let  $i \in \mathbb{Z}_{\geq 0}$  and denote by  $\Delta_q(i)$  the  $i$ -th Weyl module. This is the  $\mathbb{Q}(q)$ -vector space with basis  $m_0, \dots, m_i$  and an  $\mathbf{U}_q$ -action defined by

$$Km_k = q^{i-2k}m_k, \quad E^{(j)}m_k = \begin{bmatrix} i - k + j \\ j \end{bmatrix} m_{k-j}, \quad F^{(j)}m_k = \begin{bmatrix} k + j \\ j \end{bmatrix} m_{k+j},$$

with the convention that  $m_{<0} = m_{>i} = 0$ . The  $i$ -th dual Weyl module, denoted by  $\nabla_q(i)$ , is obtained from  $\Delta_q(i)$  by taking the dual, that is,  $\text{Hom}_{\mathbb{Q}(q)}(\Delta_q(i), \mathbb{Q}(q)) = (\Delta_q(i))^* = \nabla_q(i)$ . ▲

It is easy to check directly that  $\Delta_q(i)$  has a *unique simple head*  $L_q(i)$  which is also the *unique simple socle* of  $\nabla_q(i)$ . See also [5, Section 4].

<sup>4</sup>The square is only important for roots of unity of even order, but not for roots of unity of odd order (for these the order of  $q^2$  is the same as the order of  $q$ ), e.g. we have  $l = 3$  for third as well as for sixth roots of unity.

**Example 2.6.** Let  $q = \frac{-1+\sqrt{-3}}{2}$  (we use this  $q$  in all examples with  $l = 3$  in what follows).

The Weyl module  $\Delta_q(3)$  can be visualized as

$$(2) \quad \begin{array}{ccccccc} \binom{q^{-3}}{m_3} & \xrightleftharpoons[0]{+1} & \binom{q^{-1}}{m_2} & \xrightleftharpoons[-1]{-1} & \binom{q^0}{m_1} & \xrightleftharpoons[+1]{0} & \binom{q^3}{m_0} \end{array}$$

Here the action of  $E$  points right, the action of  $F$  left,  $E^{(3)}m_3 = m_0$ ,  $F^{(3)}m_0 = m_3$ ,  $K$  acts as a loop and all other actions are zero. Thus, the  $\Lambda$ -span of  $\{m_1, m_2\}$  is now, in contrast to the classical case, stable under the action of  $U_q$ . The complement however is not an  $U_q$ -submodule.

Another example (where we have excluded the actions of the divided powers) is  $\Delta_q(4)$ :

$$(3) \quad \begin{array}{ccccccccc} \binom{q^{-4}}{m_4} & \xrightleftharpoons[+1]{+1} & \binom{q^{-2}}{m_3} & \xrightleftharpoons[0]{-1} & \binom{q^0}{m_2} & \xrightleftharpoons[-1]{0} & \binom{q^2}{m_1} & \xrightleftharpoons[+1]{+1} & \binom{q^4}{m_0} \end{array}$$

We note that  $\Delta_q(4)$  has the trivial  $U_q$ -module spanned by  $m_2$  as a  $U_q$ -submodule. ▲

$K$  acts on  $\Delta_q(i)$  via the eigenvalues  $q^{-i}, q^{-i+2}, \dots, q^{i-2}, q^i$ . Thus, by (1), the same is true for  $\nabla_q(i)$ . Moreover, the  $L_q(i)$  are self-dual, see e.g. [5, Section 4].

**Proposition 2.7.** We have the following.

- (a)  $\Delta_q(i) \cong L_q(i)$  iff  $i < l$  or  $i \equiv -1 \pmod{l}$ .
- (b) Suppose  $i = al + b$  for some  $a, b \in \mathbb{Z}_{\geq 0}$  with  $b \leq l - 2$ . Set  $i' = (a + 2)l - b - 2$ . Then there exists a short exact sequence

$$0 \longrightarrow L_q(i) \hookrightarrow \Delta_q(i') \twoheadrightarrow L_q(i') \longrightarrow 0.$$

Moreover,  $L_q(i')$  is the head and  $L_q(i)$  is the socle of  $\Delta_q(i')$ . □

*Proof.* This is [5, Corollary 4.6]. ■

**Corollary 2.8.** We have the following.

- (a)  $\nabla_q(i) \cong L_q(i)$  iff  $i < l$  or  $i \equiv -1 \pmod{l}$ .
- (b) Suppose  $i = al + b$  for some  $a, b \in \mathbb{Z}_{\geq 0}$  with  $b \leq l - 2$ . Set  $i' = (a + 2)l - b - 2$ . Then there exists a short exact sequence

$$0 \longrightarrow L_q(i') \hookrightarrow \nabla_q(i') \twoheadrightarrow L_q(i) \longrightarrow 0.$$

Moreover,  $L_q(i')$  is the socle and  $L_q(i)$  is the head of  $\nabla_q(i')$ . □

*Proof.* This follows from  $L_q(i) \cong (L_q(i))^*$  and the fact that  $*$  is an exact, contravariant functor. ■

**Example 2.9.** For  $i = 0$  and  $l = 3$  we have  $i' = 4$ . The trivial  $U_q$ -module  $L_q(0)$  appears as a submodule of  $\Delta_q(4)$ , compare to (3). ▲

We should note here that there are two different types of  $U_q$ -modules known as *type 1* and  $-1$ , see for example [5, Section 1]. For us the difference between the two types is not important in this paper and we *only* consider  $U_q$ -modules of type 1. The (more general) treatment in [5, Section 1] ensures that the consideration of only type 1 is still enough to get results for both types.

**Corollary 2.10.** The set  $\{L_q(i) \mid i \in \mathbb{Z}_{\geq 0}\}$  is a complete set of simple, pairwise non-isomorphic, finite-dimensional  $U_q$ -modules (of type 1). □

*Proof.* See [5, Corollary 6.3]. ■

**Remark 2.11.** The category of  $U_q$ -modules is *far* from being semisimple: Proposition 2.7 says that  $\Delta_q(i)$  is never simple whenever we are in the case (b). See also (2).  $\blacktriangle$

### 2.3. Tilting modules and the tilting category $\mathfrak{T}$ .

**Definition 2.12. ( $\Delta$ - and  $\nabla$ -filtration)** We say that a  $U_q$ -module  $M$  has a  $\Delta$ -filtration if there exists a descending sequence of  $U_q$ -submodules

$$M = F_0 \supset F_1 \supset \cdots \supset F_i \supset \cdots, \quad \bigcap_{i=0}^{\infty} F_i = 0,$$

such that for all  $i = 0, 1, \dots$  we have  $F_i/F_{i+1} \cong \Delta_q(i')$  for some  $i' \in \mathbb{Z}_{\geq 0}$ . A  $\nabla$ -filtration is defined similarly, but using  $\nabla_q(i')$  instead of  $\Delta_q(i')$  and an ascending sequence of  $U_q$ -submodules, that is

$$0 = F_0 \subset F_1 \subset \cdots \subset F_i \subset \cdots, \quad \bigcup_{i=0}^{\infty} F_i = M,$$

such that for all  $i = 0, 1, \dots$  we have  $F_{i+1}/F_i \cong \nabla_q(i')$  for some  $i' \in \mathbb{Z}_{\geq 0}$ .  $\blacktriangle$

One can prove, following similar arguments as in [26, Proposition II.4.16], that such filtrations are unique up to reordering. It is clear that a finite-dimensional  $U_q$ -module  $M$  has a  $\Delta$ -filtration iff  $M^*$  has a  $\nabla$ -filtration.

**Definition 2.13. (Tilting modules)** We call a  $U_q$ -module  $M$  a  $U_q$ -tilting module if it has a  $\Delta$ - and a  $\nabla$ -filtration. We say for short that  $M$  is *tilting*.  $\blacktriangle$

**Example 2.14.** Recall that the category of finite-dimensional  $U_v$ -modules is semisimple. It follows that all finite-dimensional  $U_v$ -modules are tilting. Moreover, for  $i < l$  or  $i \equiv -1 \pmod{l}$ , by Proposition 2.7 and Corollary 2.8, we see that  $\Delta_q(i) \cong L_q(i) \cong \nabla_q(i)$  is tilting.  $\blacktriangle$

It is easy to see (in our  $\mathfrak{sl}_2$  case - in general this is non-trivial, see e.g. [47, Theorem 3.3]) that  $\Delta_q(i) \otimes_{\mathbb{Q}(q)} \Delta_q(i')$  has a  $\Delta$ -filtration with factors (likewise for  $\nabla_q(i) \otimes_{\mathbb{Q}(q)} \nabla_q(i')$ )

$$(4) \quad \Delta_q(|i - i'|), \Delta_q(|i - i'| + 2), \dots, \Delta_q(i + i' - 2), \Delta_q(i + i'), \quad i, i' \geq 0.$$

**Definition 2.15. (Full tilting category)** We denote by  $\mathfrak{T}^{\text{all}}$  the full subcategory of all  $U_q$ -modules that are tilting. We denote its class of objects by  $\text{Ob}(\mathfrak{T}^{\text{all}})$ .  $\blacktriangle$

**Proposition 2.16.** The category  $\mathfrak{T}^{\text{all}}$  has the following properties.

(a) If  $M, M' \in \text{Ob}(\mathfrak{T}^{\text{all}})$ , then  $M \oplus M' \in \text{Ob}(\mathfrak{T}^{\text{all}})$ .

(b) If  $M \oplus M' \in \text{Ob}(\mathfrak{T}^{\text{all}})$ , then  $M, M' \in \text{Ob}(\mathfrak{T}^{\text{all}})$ .

(c) If  $M, M' \in \text{Ob}(\mathfrak{T}^{\text{all}})$ , then  $M \otimes_{\mathbb{Q}(q)} M' \in \text{Ob}(\mathfrak{T}^{\text{all}})$ .  $\square$

*Proof.* Part (a) is immediate. For part (b) one can, for example, argue as in [24, Proposition 3.7], and the non-trivial part (c) can be deduced from (4) and the corresponding statement for the dual Weyl modules  $\nabla_q(i)$ .  $\blacksquare$

**Definition 2.17. (The tilting category  $\mathfrak{T}$ )** Let  $\mathfrak{T}$  be the full subcategory of  $\mathfrak{T}^{\text{all}}$  consisting of:

- The objects  $\text{Ob}(\mathfrak{T})$  are all finite-dimensional  $U_q$ -tilting modules  $M \in \text{Ob}(\mathfrak{T}^{\text{all}})$ .
- The morphisms  $\text{Hom}_{\mathfrak{T}}(M, N)$  are all  $U_q$ -intertwiners  $f \in \text{Hom}_{U_q}(M, N)$ .

The objects of  $\mathfrak{T}$  have finite filtrations, i.e.  $F_N = F_{N+i}$  for some  $N \in \mathbb{Z}_{\geq 0}$  and all  $i \in \mathbb{Z}_{\geq 0}$ .  $\blacktriangle$



Recall that an additive category is *Krull-Schmidt*, if each object can be uniquely decomposed (up to permutation) into a finite direct sum of *indecomposable objects*, i.e. objects  $O$  such that  $O \cong O' \oplus O''$  implies that  $O' \cong 0$  or  $O'' \cong 0$ .

**Lemma 2.18.** We have the following.

- (a) The category  $\mathfrak{T}$  is additive (but not abelian), closed under finite direct sums, finite tensor products and under duals.
- (b)  $\mathfrak{T}$  is a Krull-Schmidt category whose indecomposable objects are parametrized by  $\mathbb{Z}_{\geq 0}$ .
- (c)  $\Delta_q(i)$ ,  $\nabla_q(i)$  and  $L_q(i)$  are in  $\mathfrak{T}$  iff  $i < l$  or  $i \equiv -1 \pmod{l}$ .  $\square$

*Proof.* (a). From Proposition 2.16 and the fact that  $\text{Hom}_{\mathbf{U}_q}(\cdot, \mathbb{Q}(q))$  commutes with finite sums.

(b). The Krull-Schmidt property follows from finite-dimensionality and (b) of Proposition 2.16. By Proposition 2.20 below, all finite-dimensional indecomposable tiltings are of the form  $T_q(i)$ .

(c). A direct consequence of Proposition 2.7 and Corollary 2.8.  $\blacksquare$

**Remark 2.19.** It follows from Lemma 2.18 part (a) that  $\mathfrak{T}$  is a *rigid category* (a monoidal category with duals and certain compatibility properties). Moreover,  $\mathfrak{T}$  is even a *ribbon (tensor) category* and  $\mathfrak{T}$  gives rise to a *modular category* (roughly: one mods out by tiltings whose quantum trace is zero) and thus, gives a  $2 + 1$ -dimensional TQFT and can be used to define the *Witten-Reshetikhin-Turaev invariants* of 3-manifolds. Good treatments of this are [1, Section 4] or [51, Section 7].  $\blacktriangle$

Define, using Propositions 2.7 and 2.16 and (4), a family  $(T_q(i))_{i \in \mathbb{Z}_{\geq 0}}$  of indecomposable tiltings as follows. We start by setting  $T_q(0) = \Delta_q(0)$  and  $T_q(1) = \Delta_q(1)$ . Then we denote by  $m_q \in T_q(1)$  any eigenvector for  $K$  with eigenvalue  $q$ . For each  $i > 1$  we define  $T_q(i)$  to be the indecomposable summand of  $(T_q(1))^{\otimes i}$  which contains the vector  $m_q \otimes \cdots \otimes m_q \in (T_q(1))^{\otimes i}$ .

Denote by  $(T : \Delta_q(i)) \in \mathbb{Z}_{\geq 0}$  the *filtration multiplicity* for an  $\mathbf{U}_q$ -tilting module  $T$ . It is clear, by using (4), that

$$(5) \quad ((T_q(1))^{\otimes i} : \Delta_q(i)) = 1, \quad ((T_q(1))^{\otimes i} : \Delta_q(i')) = 0, \quad \text{for } i' > i.$$

Hence,  $T_q(i)$  may also be described as the unique indecomposable summand of  $(T_q(1))^{\otimes i}$  that contains  $\Delta_q(i)$ . We note the following more precise statement.

**Proposition 2.20.**

- (a)  $\Delta_q(i) \cong L_q(i) \cong T_q(i) \cong \nabla_q(i)$  iff  $i < l$  or  $i \equiv -1 \pmod{l}$ .
- (b) Suppose  $i = al + b$  for some  $a, b \in \mathbb{Z}_{\geq 0}$  with  $b \leq l - 2$ . Set  $i' = (a + 2)l - b - 2$ . Then there exist short exact sequences

$$0 \longrightarrow \Delta_q(i') \hookrightarrow T_q(i') \twoheadrightarrow \Delta_q(i) \longrightarrow 0, \quad 0 \longrightarrow \nabla_q(i) \hookrightarrow T_q(i') \twoheadrightarrow \nabla_q(i') \longrightarrow 0.$$

- (c) We have  $T_q(i) \cong T_q(i')$  iff  $i = i'$ . Moreover, if  $M \in \text{Ob}(\mathfrak{T})$  is indecomposable, then there exists an  $i \in \mathbb{Z}_{\geq 0}$  such that  $M \cong T_q(i)$ .  $\square$

*Proof.* (a). Clear by Proposition 2.7 and Corollary 2.8.

(b). First let  $T = \Delta_q((a + 1)l - 1) \otimes \Delta_q(1)$ . Then  $T = T_q((a + 1)l - 1) \otimes T_q(1)$  by (a), and, by (4), we see that  $T$  has a  $\Delta_q$ -filtration giving us the short exact sequence

$$0 \longrightarrow \Delta_q((a + 1)l) \hookrightarrow T \twoheadrightarrow \Delta_q((a + 1)l - 2) \longrightarrow 0.$$

By duality,  $T$  has an analogous  $\nabla_q$ -filtration, showing that  $T$  is tilting. It is also indecomposable since otherwise the summand  $T_q((a + 1)l)$  of  $T$  would be equal to  $\Delta_q((a + 1)l)$ , forcing it to be simple, which contradicts (b) of Proposition 2.7. This proves the claim in case  $b = l - 2$ .

Now, if  $b < l - 2$ , then consider the diagram

$$\begin{array}{ccccccc}
0 & \longrightarrow & \Delta_q(i') & \hookrightarrow & \Delta_q(i' - 1) \otimes \Delta_q(1) & \twoheadrightarrow & \Delta_q(i' - 2) \longrightarrow 0 \\
& & & & \downarrow & & \\
& & & & T_q(i' - 1) \otimes T_q(1) & & \\
& & & & \downarrow & & \\
0 & \longrightarrow & \nabla_q(i' - 2) & \hookrightarrow & \nabla_q(i' - 1) \otimes \nabla_q(1) & \twoheadrightarrow & \nabla_q(i') \longrightarrow 0.
\end{array}$$

Here the bottom and top sequences come from (4). A computation shows that these split. This gives an inclusion  $\Delta_q(i' - 2) \hookrightarrow T_q(i' - 1) \otimes T_q(1)$  which extends to  $T_q(i' - 2)$ , and a surjection  $T_q(i' - 1) \otimes T_q(1) \twoheadrightarrow \nabla_q(i' - 2)$  factoring through  $T_q(i' - 2)$ . The resulting endomorphism of  $T_q(i' - 2)$  is non-zero on the  $i' - 2$  weight space (the reader unfamiliar with this notion might consider Remark 2.29 where the notation is  $M_i$  for the  $i$ -th weight space) and thus, an isomorphism. Hence,  $T_q(i' - 1) \otimes T_q(1) \cong T_q(i' - 2) \oplus T$  for some  $\mathbf{U}_q$ -module  $T$ , which is tilting by (a) of Lemma 2.18. Using an inductive argument, we have that  $T$  has two  $\Delta_q$ - and  $\nabla_q$ -factors as in the statement of (b). As above, we see that  $T = T_q(i')$ , which proves the claim.

(c). To see the first statement note that it suffices to show that  $T_q(i) \not\cong T_q(i')$  for  $i \neq i'$ . To this end, assume without loss of generality that  $i' > i$ . By (5), we see that  $\Delta_q(i')$  appears with multiplicity 1 in  $T_q(i')$ , but not in  $T_q(i)$ . Thus,  $T_q(i) \not\cong T_q(i')$ . That every finite-dimensional indecomposable tilting is of this form needs a little bit more treatment. But it is a standard argument that appears in various contexts and can be adopted for example from [24, Section 11.2] or, alternatively, from [26, Chapter II, Section E.6].  $\blacksquare$

**Example 2.21.** Let  $l = 3$  again. The  $\mathbf{U}_q$ -tilting module  $T_q(2)$  can be visualized as

$$\begin{array}{c}
\otimes \cdots \cdots \cdots \begin{array}{ccc} \overset{q^{-1}}{\curvearrowright} & & \overset{q^{+1}}{\curvearrowright} \\ m_1 & \xrightleftharpoons[1]{1} & m_0 \end{array} \\
\vdots \\
\begin{array}{ccccc} \overset{q^{-1}}{\curvearrowright} m_1 & & \overset{q^{-2}}{\curvearrowright} m_{11} & \xrightleftharpoons[1]{1} & m_{01} \overset{q^0}{\curvearrowright} \\ \uparrow 1 & & \uparrow 1 & & \uparrow 1 \\ \overset{q^{+1}}{\curvearrowright} m_0 & & \overset{q^0}{\curvearrowright} m_{10} & \xrightleftharpoons[1]{1} & m_{00} \overset{q^{+2}}{\curvearrowright} \end{array}
\end{array}$$

where we use  $m_{ij} = m_i \otimes m_j$ . By construction,  $T_q(2)$  contains  $m_{00}$  and it therefore has to be the span of  $\{m_{00}, q^{-1}m_{10} + m_{01}, m_{11}\}$  as indicated above (which is isomorphic to  $L_q(2)$ ).  $\blacktriangle$

**Remark 2.22.** One can show that the category of all finite-dimensional projective  $\mathbf{U}_q$ -modules is a full subcategory of  $\mathfrak{T}$ . The same is true for finite-dimensional injective  $\mathbf{U}_q$ -modules:  $\mathfrak{T}$  has enough injectives and projectives. In fact,  $T_q(i)$  is injective and projective for all  $i \geq l - 1$ . Hence,  $\{T_q(i) \mid i \geq l - 1\}$  is a complete set of pairwise non-isomorphic, projective-injective indecomposable, finite-dimensional  $\mathbf{U}_q$ -modules. See for example [1, Section 5]  $\blacktriangle$

**2.4. The linkage principle and blocks.** Consider the alcove  $\mathcal{A}_0$  and its closure  $\bar{\mathcal{A}}_0$  given by

$$\mathcal{A}_0 = \{k \in \mathbb{Z} \mid -1 < k < l - 1\}, \quad \bar{\mathcal{A}}_0 = \{k \in \mathbb{Z} \mid -1 \leq k \leq l - 1\}.$$

We call  $\mathcal{A}_0$  the *fundamental alcove*. Any other alcove in  $\mathbb{Z}_{\geq -1}$  is clearly of the form  $\mathcal{A}_0 + il$  for some  $i \in \mathbb{Z}_{\geq 0}$ . Moreover, we call  $-1, l - 1 \in \bar{\mathcal{A}}_0 - \mathcal{A}_0$  *walls of  $\mathcal{A}_0$* .

The *affine Weyl group* is  $W_l = \langle s_r, t_r \mid r \in \mathbb{Z} \rangle$  where  $s_r$  and  $t_r$  act on  $\mathbb{Z}$  via

$$s_r.k = -k - 2 + (4r + 2)l, \quad t_r.k = -k - 2 + 4rl, \quad k \in \mathbb{Z}$$

Note that  $W_l$  is isomorphic to the infinite dihedral group  $D_\infty$ : we have  $W_l \cong \mathbb{Z}/2\mathbb{Z} \ltimes l\mathbb{Z} \cong D_\infty$  (with  $\mathbb{Z}/2\mathbb{Z}$  being the Weyl group of  $\mathfrak{sl}_2$ ) and we denote the two generators of  $D_\infty$  by  $s$  and  $t$  (with the evident association). They act ‘‘alcove-wise’’ as indicated in (6).

We denote by  $W_l.x$  the orbits in  $\mathbb{Z}_{\geq -1}$  under the action of the affine Weyl group acting on  $x \in \mathbb{Z}_{\geq -1}$ . For  $l = 3$  this can be visualized as

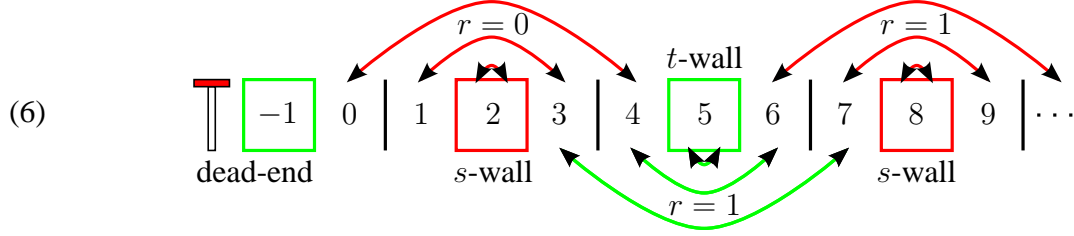

with red (or top) action by  $s$  and green (or bottom) action by  $t$ .

We say  $i \in \mathbb{Z}_{\geq 0}$  is *linked* to  $i' \in \mathbb{Z}_{\geq 0}$  if there exists  $w \in W_l$  such that  $w.i = i'$ . We, by convention, set all  $U_q$ -modules indexed by negative numbers to be zero.

The following is known as the  *$\mathfrak{sl}_2$ -linkage principle*. The more general (and highly non-trivial) statement can be found in [2, Corollaries 4.4 and 4.6].

**Theorem 2.23. (The linkage principle)** All composition factors of  $T_q(i)$  have maximal weights  $i'$  linked to  $i$ . Moreover,  $T_q(i)$  is a simple  $U_q$ -module if  $i \in W_l.(\bar{\mathcal{A}}_0 - \mathcal{A}_0)$ .

In addition, if  $i$  is linked to an element of  $\mathcal{A}_0$ , then  $T_q(i)$  is a simple  $U_q$ -module iff  $i \in \mathcal{A}_0$ .  $\square$

*Proof.* Use Propositions 2.7 and 2.20 and Corollary 2.8.  $\blacksquare$

**Notation 2.24.** We *always* use  $\lambda$  for elements in the fundamental alcove  $\mathcal{A}_0$  and  $\mu$  for elements on the walls of the fundamental alcove  $\bar{\mathcal{A}}_0 - \mathcal{A}_0$ . Moreover, set

$$\mathcal{A}_i = \{i' \mid il - 1 < i' < (i+1)l - 1\} = \mathcal{A}_0 + il, \quad \bar{\mathcal{A}}_i = \{i' \mid il - 1 \leq i' \leq (i+1)l - 1\} = \bar{\mathcal{A}}_0 + il,$$

for each  $i \in \mathbb{Z}_{\geq 0}$ . Suppose  $\lambda \in \mathcal{A}_0$  and  $\mu \in \bar{\mathcal{A}}_0 - \mathcal{A}_0$ . We write  $\lambda_i$  and  $\mu_i$  for the unique elements in  $\mathcal{A}_i \cap W_l.\lambda$  and  $\bar{\mathcal{A}}_i \cap W_l.\mu$ . Note that, if  $\mu = \mu_0 = -1$ , then  $\mu_1 = \mu_2, \mu_3 = \mu_4$  and so forth, while for  $\mu = \mu_0 = l - 1$  we have  $\mu_0 = \mu_1, \mu_2 = \mu_3$  etc. See also (6).  $\blacktriangle$

We define the tilting generator  $T_q(\infty)$  and its cut-off's  $T_q(\leq \mathbf{m})$  that will play a crucial role in Section 3. By abuse of notation, we denote them in the same way for all  $\lambda$  and  $\mu$  and hope that it is clear from the context which ones we consider.

**Definition 2.25. (The tilting generator)** Let  $m \in \mathbb{Z}_{\geq 0} \cup \{\infty\}$ . We call the  $U_q$ -modules given by

$$T_q(\infty) = \bigoplus_{i=0}^{\infty} T_q(\lambda_i) \quad \text{and} \quad T_q(\leq \mathbf{m}) = \bigoplus_{i=0}^m T_q(\lambda_i)$$

the *tilting generator* and its *m-th cut-off*, respectively. Likewise for  $\mu$ 's instead of  $\lambda$ 's.  $\blacktriangle$

Denote by  $\mathfrak{T}_\lambda$  for  $\lambda \in \mathcal{A}_0$  the  $\lambda$  *block of  $\mathfrak{T}$* : all indecomposable summands of objects of  $\mathfrak{T}_\lambda$  should be of the form  $T_q(i)$  for  $i \in W_l.\lambda$ . Note that blocks are in general not indecomposable as categories. We, using a similar notation on walls, note the following.

**Lemma 2.26.** We have

$$\mathfrak{T} = \bigoplus_{\lambda \in \mathcal{A}_0} \mathfrak{T}_\lambda \oplus \mathfrak{T}_{-1} \oplus \mathfrak{T}_{l-1}$$

with semisimple categories  $\mathfrak{T}_{-1}$  and  $\mathfrak{T}_{l-1}$  equivalent to the corresponding  $U_v$ -module categories. We have for all  $\lambda \in \mathcal{A}_0$  (similar for  $\mathfrak{T}_{-1}$  and  $\mathfrak{T}_{l-1}$ ):

- (a) The categories  $\mathfrak{T}_\lambda$  are additive, closed under finite direct sums and under duals.
- (b) The categories  $\mathfrak{T}_\lambda$  are full Krull-Schmidt subcategories of  $\mathfrak{T}$ . Moreover, every indecomposable tilting in  $\mathfrak{T}_\lambda$  is of the form  $T_q(i)$  for some  $i \in \mathbb{Z}_{\geq 0}$  and  $i \in W_l \cdot \lambda$ .  $\square$

*Proof.* This is now only a combination of Theorem 2.23 and Lemma 2.18. Note that  $\mathfrak{T}_{-1}$  and  $\mathfrak{T}_{l-1}$  are equivalent to categories of  $U_v$ -modules by Proposition 2.20 part (a).  $\blacksquare$

**Notation 2.27.** If it is clear from the context which  $\lambda$  we consider, then we, by abuse of notation, write  $T_q(\lambda_i) = T_q(\mathbf{i})$  for short. Similarly for simple and (dual) Weyl modules, and on walls.  $\blacktriangle$

**Example 2.28.** Take  $l = 3$  again. Then we only have to consider  $\lambda = 0, 1$  and  $\mu = -1, 2$ .

The indecomposable tiltings in  $\mathfrak{T}_0$  are  $T_q(i)$  for  $i = 0, 4, 6, \dots$  as a look at (6) indicates. For  $\mathfrak{T}_1$  they are  $T_q(i)$  for  $i = 1, 3, 7, \dots$ . The two blocks  $\mathfrak{T}_{-1}$  and  $\mathfrak{T}_2$  are semisimple and consist of direct sums of  $L_q(i) \cong T_q(i)$  for  $i = 5, 11, \dots$  and for  $i = 2, 8, \dots$  respectively.  $\blacktriangle$

**Remark 2.29.** As in the usual case for an indeterminate  $v$ , we have a triangular decomposition  $U_q = U_q^- U_q^0 U_q^+$ , see for example [5, Section 1]. There is a character  $\chi_i: U_q^0 \rightarrow \mathbb{Q}(q)$  for any  $i \in \mathbb{Z}_{\geq 0}$  (how the character is determined by  $i$  can be found in [5, Lemma 1.1]). We note that the Weyl module  $\Delta_q(i)$  has the following *universal property*: for any  $U_q$ -module  $M$  there is an isomorphism of vector spaces

$$\mathrm{Hom}_{U_q}(\Delta_q(i), M) \cong \{m \in M_i \mid E^{(j)}m = 0 \text{ for all } j \in \mathbb{Z}_{\geq 0}\},$$

where  $M_i = \{m \in M \mid um = \chi_i(u)m, u \in U_q^0\}$  is the  $i$  weight space of  $M$ . This together with Definition 2.5, Proposition 2.7 and Corollary 2.8 imply that

$$\mathrm{Hom}_{U_q}(\Delta_q(i), L_q(j)) \cong \mathrm{Hom}_{U_q}(\Delta_q(i), \nabla_q(j)) \cong \delta_{ij} \mathbb{Q}(q)$$

for all  $i, j \in \mathbb{Z}_{\geq 0}$ . In particular,

$$(7) \quad \mathrm{Hom}_{U_q}(L_q(i), L_q(j)) \cong \delta_{ij} \mathbb{Q}(q),$$

i.e. Schur's Lemma holds in our set-up (although  $\mathbb{Q}(q)$  is not algebraically closed). Note that this is true for general quantum groups over arbitrary fields, see [5, Corollary 7.4]. In addition<sup>5</sup>, we get

$$\mathrm{Hom}_{U_q}(\nabla_q(i), \Delta_q(i)) \cong \mathbb{Q}(q).$$

for all  $i \in \mathbb{Z}_{\geq 0}$  (by using Proposition 2.7 and Corollary 2.8).  $\blacktriangle$

We call the following maps *up*  $u_i^\lambda$ , *down*  $d_i^\lambda$  and *loop*  $\varepsilon_i^\lambda$  (or simply  $u_i, d_i$  and  $\varepsilon_i$ ) respectively.

**Proposition 2.30.** There exist up to scalars unique  $U_q$ -intertwiners  $u_i^\lambda, d_i^\lambda$  with

$$\begin{aligned} u_i^\lambda: T_q(\lambda_i) &\rightarrow T_q(\lambda_{i+1}), \quad i = 0, 1, \dots, & d_i^\lambda: T_q(\lambda_i) &\rightarrow T_q(\lambda_{i-1}), \quad i = 1, 2, \dots, \\ u_i^\lambda \circ u_{i-1}^\lambda &= 0 = d_i^\lambda \circ d_{i+1}^\lambda, \quad i = 1, 2, \dots, & d_{i+1}^\lambda \circ u_i^\lambda &= \varepsilon_i^\lambda = u_{i-1}^\lambda \circ d_i^\lambda, \quad i = 1, 2, \dots \\ \varepsilon_i^\lambda \circ \varepsilon_i^\lambda &= 0, \quad i = 1, 2, \dots, & d_1^\lambda \circ u_0^\lambda &= 0, \end{aligned}$$

for  $\lambda \in \mathcal{A}_0$ . The equation on the bottom right is called the *dead-end relation*.  $\square$

<sup>5</sup>We point out that this fails in general. An explicit counterexample can be found for example in [4, Section 5].

*Proof.* First let us assume that we are not in case of the dead-end relation (in fact, we leave it to the reader to verify this special case), that is, the indices  $i$  are at least 1. We want to use Proposition 2.7 and Corollary 2.8. Moreover, we note that the  $U_q$ -morphisms below will only be unique up to scalars and their precise form does not matter. We only assume that they are non-zero. In fact, by abuse of notation, we always use the same symbols, but the maps are of course different in general.

We consider

$$\begin{array}{c}
L_q(\lambda_i) \hookrightarrow \nabla_q(\lambda_i) \xrightarrow{a} L_q(\lambda_{i-1}) \\
\downarrow b \\
L_q(\lambda_{i-1}) \xrightarrow{c} \Delta_q(\lambda_i) \xrightarrow{d} L_q(\lambda_i) \\
\downarrow e \\
L_q(\lambda_i) \xrightarrow{f} \nabla_q(\lambda_i) \twoheadrightarrow L_q(\lambda_{i-1}).
\end{array}$$

Hence, we see that  $\text{Hom}_{U_q}(\nabla_q(\lambda_i), \Delta_q(\lambda_i))$  is one dimensional: as noted in Remark 2.29, the hom-spaces between Weyl and dual Weyl modules are at most 1-dimensional. The composite  $cba$  ensures that the dimension is exactly 1 since it spans the hom-space.

Likewise for  $\text{Hom}_{U_q}(\Delta_q(\lambda_i), \nabla_q(\lambda_i))$  by using  $fed$ . Note that the composite  $fedcba = 0$  due to the fact that the middle row is exact. The same holds when the roles of  $\Delta_q(\lambda_i)$  and  $\nabla_q(\lambda_i)$  are exchanged. Moreover, note that the morphism from  $\nabla_q(\lambda_i)$  to  $\Delta_q(\lambda_i)$  uses only  $L_q(\lambda_{i-1})$  while the other way around uses only  $L_q(\lambda_i)$ . Thus, up to scalars, morphisms from  $\nabla_q(\lambda_i)$  to  $\Delta_q(\lambda_i)$  are the “same” as morphisms from  $\Delta_q(\lambda_{i-1})$  to  $\nabla_q(\lambda_{i-1})$ . We can now construct, by using Proposition 2.20, up  $u_i^\lambda$  and down  $d_i^\lambda$  as a composition of the following maps.

$$\begin{array}{c}
\Delta_q(\lambda_i) \hookrightarrow T_q(\lambda_i) \xrightarrow{a} \Delta_q(\lambda_{i-1}) \\
\downarrow b \\
\Delta_q(\lambda_{i-1}) \xrightarrow{c} T_q(\lambda_{i-1}) \xrightarrow{d} \Delta_q(\lambda_{i-2}) \\
\downarrow e \\
\Delta_q(\lambda_{i-2}) \xrightarrow{f} T_q(\lambda_{i-2}) \twoheadrightarrow \Delta_q(\lambda_{i-3}).
\end{array}$$

We define  $d_i^\lambda$  to be the composite  $cba$ . Similar for  $u_i^\lambda$ , but using the right-hand side of part (b) of Proposition 2.20. By the same reasoning as above we see that they are unique up to scalars.

We have to check the relations between the various up  $u_i^\lambda$  and down  $d_i^\lambda$  maps now. To see that  $u_i^\lambda \circ u_{i-1}^\lambda = 0$  and  $d_i^\lambda \circ d_{i+1}^\lambda = 0$  we can simply use the second diagram above and its dual counterpart and the fact that the rows are exact. Now consider

$$\begin{array}{ccccccc}
T_q(\lambda_{i-1}) & \longleftarrow & \Delta_q(\lambda_{i-1}) & \longleftarrow & T_q(\lambda_i) & \twoheadrightarrow & \nabla_q(\lambda_i) \hookrightarrow T_q(\lambda_{i+1}) \\
\uparrow \text{id} & & L_q(\lambda_{i-1}) \downarrow L_q(\lambda_{i-1}) & & \uparrow \text{id} & & L_q(\lambda_{i-1}) \downarrow L_q(\lambda_{i-1}) & \uparrow \text{id} \\
T_q(\lambda_{i-1}) & \twoheadrightarrow & \nabla_q(\lambda_{i-1}) & \hookrightarrow & T_q(\lambda_i) & \longleftarrow & \Delta_q(\lambda_i) & \longleftarrow T_q(\lambda_{i+1})
\end{array}$$

Combining everything, we see that (up to scalars)  $d_{i+1}^\lambda \circ u_i^\lambda = \varepsilon_i^\lambda = u_{i-1}^\lambda \circ d_i^\lambda \neq 0$ . Moreover, by the reasoning above, the  $\varepsilon_i^\lambda$  is an up to scalars unique non-zero  $U_q$ -morphism  $T_q(\lambda_i)$  to  $T_q(\lambda_i)$  that squares to zero.  $\blacksquare$

**Corollary 2.31.** Let  $i, i' \in \mathbb{Z}_{\geq 0}$ . Then we have the following.

(a) Outside of walls:

$$\mathrm{Hom}_{\mathbf{U}_q}(T_q(\lambda_i), T_q(\lambda_{i'})) \cong \begin{cases} \mathbb{Q}(q)[\varepsilon], & \text{if } |i - i'| = 0 \text{ and } i = i' \neq 0, \\ \mathbb{Q}(q), & \text{if } |i - i'| = 1 \text{ or } i = i' = 0, \\ 0, & \text{if } |i - i'| > 1, \end{cases}$$

where  $\mathbb{Q}(q)[\varepsilon] \cong \mathbb{Q}(q)[X]/(X^2)$  denotes the  $\mathbb{Q}(q)$ -algebra of dual numbers.

(b) On walls:

$$\mathrm{Hom}_{\mathbf{U}_q}(T_q(\mu_i), T_q(\mu_{i'})) \cong \begin{cases} \mathbb{Q}(q), & \text{if } |i - i'| = 0, \\ 0, & \text{if } |i - i'| > 0, \end{cases}$$

where  $\mathbb{Q}(q)$  is the trivial  $\mathbf{U}_q$ -module.  $\square$

*Proof.* Because of Proposition 2.30, we only need to verify (b). But since the  $T_q(\mu_i)$  are simple on walls (by Proposition 2.20), part (b) follows from ‘‘Schur’s Lemma’’ (7).  $\blacksquare$

**2.5. Translation functors.** Fix  $\lambda \in \mathcal{A}_0$  and  $\mu \in \bar{\mathcal{A}}_0 - \mathcal{A}_0$ . Set  $\nu = |\lambda - \mu|$  (in fact,  $\nu = |\lambda_i - \mu_i|$  for all  $i \in \mathbb{Z}_{\geq 0}$  and  $\nu$  will stay in  $\bar{\mathcal{A}}_0$ ). Recall that there is a unique simple  $\mathbf{U}_q$ -module  $L_q(\nu) \cong T_q(\nu)$ . Denote by  $p_\lambda: \mathfrak{T} \rightarrow \mathfrak{T}_\lambda$  the *projection onto the block*  $\mathfrak{T}_\lambda$  functor. Similarly for  $\mu$ .

**Definition 2.32. (Onto and out of the wall)** Given  $\lambda$  and  $\mu$ , we define two functors via

$$\mathcal{T}_\lambda^\mu: \mathfrak{T}_\lambda \rightarrow \mathfrak{T}_\mu, M \mapsto p_\mu(M \otimes_{\mathbb{Q}(q)} T_q(\nu)), \quad \mathcal{T}_\mu^\lambda: \mathfrak{T}_\mu \rightarrow \mathfrak{T}_\lambda, M \mapsto p_\lambda(M \otimes_{\mathbb{Q}(q)} T_q(\nu)).$$

We call them *translation onto* the  $\mu$ -wall  $\mathcal{T}_\lambda^\mu$  and *translation out of* the  $\mu$ -wall  $\mathcal{T}_\mu^\lambda$ .  $\blacktriangle$

**Definition 2.33. (Through the wall)** Define  $\Theta_s^\lambda = \mathcal{T}_{-1}^\lambda \circ \mathcal{T}_\lambda^{-1}$  and  $\Theta_t^\lambda = \mathcal{T}_{l-1}^\lambda \circ \mathcal{T}_\lambda^{l-1}$ . We call them *translation through the wall functors*.  $\blacktriangle$

If it is clear which  $\lambda$  we are using we, abusing notation, denote them by  $\Theta_s, \Theta_t$ .

**Proposition 2.34.** For all  $i \in \mathbb{Z}_{\geq 0}$  we have the following.

- (a) The functors  $\mathcal{T}_\lambda^\mu$  and  $\mathcal{T}_\mu^\lambda$  are well-defined (their definition gives  $\mathbf{U}_q$ -tilting modules in the right blocks), adjoints (left and right) and exact. Thus,  $\Theta_s^\lambda$  and  $\Theta_t^\lambda$  are exact and self-adjoint.
- (b) We have (recalling that  $L_q(\mu_i) \cong T_q(\mu_i)$ )

$$\mathcal{T}_\lambda^\mu(T_q(\lambda_i)) \cong \begin{cases} T_q(\mu_{i-1}) \oplus T_q(\mu_{i+1}), & \text{if } \mu_i > \lambda_i, \\ T_q(\mu_i) \oplus T_q(\mu_i), & \text{if } \mu_i < \lambda_i, \end{cases} \quad \mathcal{T}_\mu^\lambda(T_q(\mu_i)) \cong \begin{cases} T_q(\lambda_{i+1}), & \text{if } \mu_i > \lambda_i, \\ T_q(\lambda_i), & \text{if } \mu_i < \lambda_i. \end{cases}$$

- (c) The dead-end relations  $\Theta_s^\lambda(T_q(\lambda_0)) \cong 0$ ,  $\Theta_s^\lambda(T_q(\lambda_1)) \cong T_q(\lambda_2)$ , and  $\Theta_t^\lambda(T_q(\lambda_0)) \cong T_q(\lambda_1)$ . Moreover, we have

$$\Theta_{s \text{ or } t}^\lambda(T_q(\lambda_i)) \cong \begin{cases} T_q(\lambda_{i-1}) \oplus T_q(\lambda_{i+1}), & \text{if } i > 1 \text{ is odd for } s \text{ and even for } t, \\ T_q(\lambda_i) \oplus T_q(\lambda_i), & \text{if } i > 0 \text{ is odd for } t \text{ and even for } s. \end{cases}$$

Here we set  $T_q(-1) = T_q(\lambda_{-1}) = T_q(\mu_{-1}) = 0$ .  $\square$

Note that biadjoint functors have in addition some other nice properties, see e.g. [32, Section 2]. Moreover, in the case  $\mu = -1$  we have  $\mu_i > \lambda_i$  iff  $i$  is odd whereas in the case  $\mu = l - 1$  we have  $\mu_i > \lambda_i$  iff  $i$  is even as a look at (6) should convince the reader.

*Proof.* (a). The functors are well-defined by (c) of Proposition 2.16 and part (b) of Lemma 2.18, i.e. tensor products of tiltings are tiltings. The other statements can be verified as in the case of category  $\mathcal{O}$ , i.e. we can adopt [24, Sections 7.1 and 7.2] without difficulties.

(b). Use Propositions 2.7 and 2.20, Corollary 2.8 and Theorem 2.23.

(c). This is just a direct application of the finer list of statements given in (b).  $\blacksquare$

We use the convention that  $\Theta_{k-tst}^\lambda$  denotes an *alternating* composition of length  $k$  of translation through the wall functors starting with  $\Theta_t^\lambda$ . Likewise for  $\Theta_{k-sts}^\lambda$ . Using (c) of Proposition 2.34, we get the following.

**Corollary 2.35. (Combinatorics of the translation through the wall functors)** We have:

(a)  $\Theta_s^\lambda \circ \Theta_s^\lambda \cong \Theta_s^\lambda \oplus \Theta_s^\lambda$  and  $\Theta_t^\lambda \circ \Theta_t^\lambda \cong \Theta_t^\lambda \oplus \Theta_t^\lambda$  as functors.

(b) We have for  $i \in \mathbb{Z}_{\geq 0}$  even respectively odd, that (with  $k \geq 0$  terms  $\Theta_{t \text{ or } s}^\lambda$ ) there exist multiplicities  $m_j \in \mathbb{Z}_{\geq 0}$  (that can be zero) such that

$$\Theta_{k-tst}^\lambda T_q(\lambda_i) = (\Theta_{s \text{ or } t}^\lambda \circ \dots \circ \Theta_t^\lambda \circ \Theta_s^\lambda \circ \Theta_t^\lambda) T_q(\lambda_i) \cong T_q(\lambda_{i+k}) \oplus \bigoplus_{j < i+k} T_q(\lambda_j)^{\oplus m_j},$$

$$\Theta_{k-tst}^\lambda T_q(\lambda_i) = (\Theta_{s \text{ or } t}^\lambda \circ \dots \circ \Theta_t^\lambda \circ \Theta_s^\lambda \circ \Theta_t^\lambda) T_q(\lambda_i) \cong T_q(\lambda_{i-1+k})^{\oplus 2} \oplus \bigoplus_{j < i-1+k} T_q(\lambda_j)^{\oplus m_j}.$$

Similarly for  $i \in \mathbb{Z}_{\geq 0}$  odd respectively even and  $\Theta_{k-sts}^\lambda$ .  $\square$

*Proof.* Clear from Proposition 2.34.  $\blacksquare$

Define the following functors:

$$\begin{aligned} \mathcal{T}_\lambda^{\mu,i} &= p_i \circ \mathcal{T}_\lambda^\mu, & \mathcal{T}_\mu^{\lambda,i}(T_q(\mu_j)) &= \begin{cases} \delta_{i,j} T_q(\lambda_i), & \text{if } \mu = -1, i \text{ even,} \\ \delta_{i,j} T_q(\lambda_i), & \text{if } \mu = l-1, i \text{ odd,} \end{cases} \\ \Theta_{s \text{ or } t}^{\lambda,i} &= \begin{cases} p_i \circ \Theta_s^\lambda, & \text{if } i \text{ is even,} \\ p_i \circ \Theta_t^\lambda, & \text{if } i \text{ is odd.} \end{cases} \end{aligned}$$

Here  $p_i$  denotes the projection to the  $T_q(\mathbf{i})$ -part.

**Definition 2.36.** Given a  $U_q$ -tilting module  $T$ , denote by  $\mathcal{F}_T$  any functor  $\mathcal{F}_T \cong \cdot \otimes_{\mathbb{Q}(q)} T$ . A functor  $\mathcal{F}: \mathfrak{T} \rightarrow \mathfrak{T}$  is called *projective* if it is a direct summand of functors of the form  $\mathcal{F}_T$ . We denote by  $p\text{End}(\mathfrak{T})$  the *category of projective endofunctors*  $\mathcal{F}: \mathfrak{T} \rightarrow \mathfrak{T}$  whose morphisms  $\text{Hom}_{p\text{End}(\mathfrak{T})}(\mathcal{F}, \mathcal{F}')$  are natural transformations  $\eta: \mathcal{F} \rightarrow \mathcal{F}'$ . Moreover, we denote by  $p\text{End}(\mathfrak{T}_\lambda)$  the *category of projective endofunctors*  $\mathcal{F}: \mathfrak{T}_\lambda \rightarrow \mathfrak{T}_\lambda$  that can be obtained via compositions and countable direct sums of functors of the form  $\Theta_{s \text{ or } t}^{\lambda,i}$ . Similarly for walls  $\mu$ . Here we count the empty sum as the identity functor.  $\blacktriangle$

It follows from Lemma 2.37 below that these are actually categories. Moreover, by construction, the translation through the wall functors  $\Theta_s^\lambda$  or  $\Theta_t^\lambda$  are objects in  $p\text{End}(\mathfrak{T}_\lambda)$ , since

$$(8) \quad \Theta_s^\lambda = \bigoplus_{i \in \mathbb{Z}_{\geq 1}} \Theta_s^{\lambda,2i}, \quad \Theta_t^\lambda = \bigoplus_{i \in \mathbb{Z}_{\geq 0}} \Theta_s^{\lambda,2i+1},$$

as follows by Proposition 2.34. Similarly,

$$(9) \quad \mathcal{T}_\lambda^\mu = \bigoplus_{i \in \mathbb{Z}_{\geq 0}} \mathcal{T}_\lambda^{\mu,i}, \quad \mathcal{T}_\mu^\lambda = \begin{cases} \bigoplus_{i \in \mathbb{Z}_{\geq 0}} \mathcal{T}_\mu^{\lambda,2i}, & \text{if } \mu = -1, \\ \bigoplus_{i \in \mathbb{Z}_{\geq 0}} \mathcal{T}_\mu^{\lambda,2i+1}, & \text{if } \mu = l-1. \end{cases}$$

**Lemma 2.37.**  $p\mathbf{End}(\mathfrak{T}), p\mathbf{End}(\mathfrak{T}_\lambda), p\mathbf{End}(\mathfrak{T}_\mu)$  are additive categories of exact functors.  $\square$

*Proof.* That  $p\mathbf{End}(\mathfrak{T})$  is closed under composition follows from part (b) of Lemma 2.18, and the identity functor is projective because of  $\text{id} \cong \cdot \otimes_{\mathbb{Q}(q)} T_q(0)$ . Hence,  $p\mathbf{End}(\mathfrak{T})$  is a category. That  $p\mathbf{End}(\mathfrak{T})$  is preserved under finite direct sums (showing that the category is additive) follows from part (a) of Lemma 2.18. The statement for the  $\lambda$  and  $\mu$  versions follow by construction. Last, that functors in  $p\mathbf{End}(\mathfrak{T})$  are exact follows because tensoring over a field always respects exact sequences. Likewise for the  $\lambda$  and  $\mu$  versions which come from projections of such functors.  $\blacksquare$

The following lemma is true in more generality (see for example [6, Chapter 4, Section 6]), but we restrict to our case here. Recall that a functor between additive categories  $\mathcal{F}: \mathcal{C} \rightarrow \mathcal{D}$  is called *indecomposable* if any decomposition  $\mathcal{F} \cong \mathcal{F}_1 \oplus \mathcal{F}_2$  implies that  $\mathcal{F}_1 \cong 0$  or  $\mathcal{F}_2 \cong 0$ . Moreover, we call a category *infinite Krull-Schmidt* if each object can be uniquely decomposed (up to permutation) into a countably infinite direct sum of indecomposable objects.

**Lemma 2.38.** A functor  $\mathcal{F} \cong \cdot \otimes_{\mathbb{Q}(q)} T$  is indecomposable iff  $T$  is an indecomposable  $U_q$ -module. Thus,  $p\mathbf{End}(\mathfrak{T})$  is Krull-Schmidt. In contrast, the  $\lambda$  and  $\mu$  versions are infinite Krull-Schmidt.  $\square$

*Proof.* Assume that  $T$  decomposes into  $T_1 \oplus T_2$ . Then  $\mathcal{F} \cong (\cdot \otimes_{\mathbb{Q}(q)} T_1) \oplus (\cdot \otimes_{\mathbb{Q}(q)} T_2)$ . On the other hand, by Yoneda and the tensor-hom adjunction, the  $T$  representing  $\mathcal{F}$  is uniquely determined up to isomorphism. Thus, a decomposition of  $\mathcal{F}$  induces a decomposition of  $T$ . This implies, by using part (a) of Lemma 2.18, that  $p\mathbf{End}(\mathfrak{T})$  is Krull-Schmidt.

The statement for the  $\lambda$  and  $\mu$  versions follow again by construction.  $\blacksquare$

**Proposition 2.39.** The functors  $\mathcal{T}_\lambda^{\mu,i}, \mathcal{T}_\mu^{\lambda,i}$  and  $\Theta_{s \text{ or } t}^{\lambda,i}$  are all indecomposable.

*Proof.* Any non-trivial decomposition  $\Theta_{s \text{ or } t}^{\lambda,i} = F_1 \oplus F_2$  gives rise to a non-trivial idempotent  $\eta \in p\mathbf{End}(\Theta_{s \text{ or } t}^{\lambda,i})$ . By using Proposition 2.34 together with Corollary 2.31 we see that such a natural transformation can not exist (most of the  $U_q$ -intertwiners are nilpotent). Let us illustrate this in an explicit calculation for  $\Theta_t^{\lambda,i}$  with  $i \neq 0$ . Applying  $\Theta_t^{\lambda,i}$  on the sequence

$$(10) \quad T_q(\mathbf{i} - 1) \begin{array}{c} \xleftarrow{u_{i-1}} \\ \xrightarrow{d_i} \end{array} T_q(\mathbf{i}) \begin{array}{c} \xrightarrow{u_i} \\ \xleftarrow{d_{i+1}} \end{array} T_q(\mathbf{i} + 1)$$

gives us (with bottom and top row given by applying  $\Theta_t^{\lambda,i}$  to (10))

$$(11) \quad \begin{array}{ccccc} & \begin{pmatrix} 0 \\ 1 \end{pmatrix} & & \begin{pmatrix} 1 & 0 \end{pmatrix} & \\ & \begin{array}{c} \xrightarrow{\quad} \\ \xleftarrow{\quad} \end{array} & T_q(\mathbf{i}) \oplus T_q(\mathbf{i}) & \begin{array}{c} \xrightarrow{\quad} \\ \xleftarrow{\quad} \end{array} & T_q(\mathbf{i}) \\ & \begin{pmatrix} 1 & 0 \end{pmatrix} & & \begin{pmatrix} 0 \\ 1 \end{pmatrix} & \\ \eta_{T_q(\mathbf{i}-1)} \uparrow & & \eta_{T_q(\mathbf{i})} \uparrow & & \eta_{T_q(\mathbf{i}+1)} \uparrow \\ & \begin{pmatrix} 0 \\ 1 \end{pmatrix} & & \begin{pmatrix} 1 & 0 \end{pmatrix} & \\ \eta_{T_q(\mathbf{i}-1)} \downarrow & \begin{array}{c} \xrightarrow{\quad} \\ \xleftarrow{\quad} \end{array} & T_q(\mathbf{i}) \oplus T_q(\mathbf{i}) & \begin{array}{c} \xrightarrow{\quad} \\ \xleftarrow{\quad} \end{array} & T_q(\mathbf{i}) \\ & \begin{pmatrix} 1 & 0 \end{pmatrix} & & \begin{pmatrix} 0 \\ 1 \end{pmatrix} & \end{array}$$

Here we used Proposition 2.34 to calculate  $\Theta_t^{\lambda,i}(T_q(i))$ , while the images of the  $U_q$ -intertwiners can be calculated as in Example 3.15. Note that  $\eta$  above is assumed to be a natural transformation, i.e. all squares in (11) commute. Now, under the assumption that  $\eta$  is an idempotent, we have  $\eta_{T_q(\mathbf{i}-1)}$



equals 0 or 1 because of Corollary 2.31. In the first case we obtain that all others components of  $\eta$  are zero as well, while in the second case we obtain that all others components of  $\eta$  are the identity as well (both follow via direct computation using Corollary 2.31, the assumption that all components of  $\eta$  are idempotents and the commutativity of all squares in (11)). The same arguments and calculations show the claim for the functors  $\Theta_s^{\lambda,i}$  and  $\mathcal{T}_\lambda^{\mu,i}$  (except that our job is even easier for the latter since all involved tiltings are simple). The claim for the functor  $\mathcal{T}_\mu^{\lambda,i}$  is left to the reader. This shows the statement.  $\blacksquare$

**Remark 2.40.** The category  $p\mathbf{End}(\mathfrak{T}_\lambda)$  is the Karoubi envelope (in the sense of Definition 4.2) of the category  $p\mathbf{End}_\Theta(\mathfrak{T}_\lambda)$  generated (via direct sums and compositions) by the translation through the wall functors  $\Theta_{s \text{ or } t}^\lambda$ . This follows from (8) and Proposition 2.39. We call  $p\mathbf{End}(\mathfrak{T}_\lambda)$  the category of projective endofunctors although it would be historical more accurate to call  $p\mathbf{End}_\Theta(\mathfrak{T}_\lambda)$  the category of projective endofunctors. This convention is due to the fact that, in contrast to the case of category  $\mathcal{O}$  (see e.g. [9]), our buildings blocks are the various  $\Theta_{s \text{ or } t}^{\lambda,i}$  and not the functors  $\Theta_{s \text{ or } t}^\lambda$  themselves.  $\blacktriangle$

### 3. THE KHOVANOV-SEIDEL QUIVER ALGEBRA AND GRADINGS

In the present section<sup>6</sup> we identify the quiver for the blocks  $\mathfrak{T}_\lambda$ . We show how the quiver description can be used to define a grading on  $\mathfrak{T}$ . We obtain a grading on  $p\mathbf{End}(\mathfrak{T})$  as well.

Additionally, we show how the translation functors of  $\mathfrak{T}_\lambda$  can be used to get a categorification of the action of the braid group on the (split) Grothendieck group of  $\mathfrak{T}_\lambda$  which realizes the Burau representation on the (split) Grothendieck group. Moreover, we show how the category of projective endofunctors on  $\mathfrak{T}_\lambda$  can be used to categorify (parts of) the Temperley-Lieb  $\mathbb{Q}(v)$ -algebras (where the grading decategorifies to the indeterminate  $v$ ).

By an algebra we always mean an associative, but not necessarily unital  $\mathbb{Q}(q)$ -algebra.

**3.1. The quiver algebras  $Q_m$  and  $Q_\infty$ .** Let  $m \in \mathbb{Z}_{\geq 0}$ . We consider the following quiver

$$(12) \quad \bullet \xrightleftharpoons[u_{m-1}]{d_m} \bullet \xrightleftharpoons[u_{m-2}]{d_{m-1}} \bullet \xrightleftharpoons[u_{m-3}]{d_{m-2}} \cdots \xrightleftharpoons[u_2]{d_3} \bullet \xrightleftharpoons[u_1]{d_2} \bullet \xrightleftharpoons[u_0]{d_1} \bullet$$

having  $m + 1$  vertices  $0, 1, \dots, m$  and  $2m$  arrows called *up and down*:

$$u_i: \mathbf{i} \rightarrow \mathbf{i} + \mathbf{1}, \quad i = 0, \dots, m-1, \quad d_i: \mathbf{i} \rightarrow \mathbf{i} - \mathbf{1}, \quad i = 1, \dots, m.$$

The *path algebra*  $P_m$  of the quiver from (12) is defined to be the  $\mathbb{Q}(q)$ -algebra whose underlying  $\mathbb{Q}(q)$ -module is the  $\mathbb{Q}(q)$ -vector space spanned by all finite paths with multiplication given by composition of paths if possible and zero otherwise.

Recall that a  $\mathbb{Z}$ -graded  $\mathbb{Q}(q)$ -algebra  $A$  (or simply *graded*) is a  $\mathbb{Q}(q)$ -algebra  $A = \bigoplus_{i \in \mathbb{Z}} A^i$  such that  $A^i A^j \subset A^{i+j}$  for all  $i, j \in \mathbb{Z}$ . The path algebra  $P_m$  is a graded  $\mathbb{Q}(q)$ -algebra<sup>7</sup>, that is

$$P_m = \bigoplus_{k \in \mathbb{Z}_{\geq 0}} P_m^k, \quad \text{with } P_m^k = \{\text{All paths in } P_m \text{ of length } k\},$$

since we clearly have  $P_m^k \circ P_m^{k'} \subset P_m^{k+k'}$ . We write  $l(\cdot)$  for the grading on  $P_m$  (the ‘‘length’’).

<sup>6</sup>We use *right* modules in this section and read from right to left: we think of the paths in the quiver as applying morphisms/functors. The reason for this will become clear in Subsection 3.4.

<sup>7</sup>Note that Khovanov and Seidel use free  $\mathbb{Z}$ -modules instead of  $\mathbb{Q}(q)$ -vector spaces. In order to avoid too many different overlapping notations, we only use the  $\mathbb{Q}(q)$ -vector space version, but it is not a big problem to work over  $\mathbb{Z}$ .

**Definition 3.1. (Khovanov-Seidel's  $m$ -quiver algebra)** Let  $Q_m$  denote the quotient algebra obtained from the path algebra  $P_m$  for the quiver from (12) by the defining relations

$$u_i \circ u_{i-1} = 0 = d_i \circ d_{i+1}, \quad i = 1, \dots, m-1, \quad d_{i+1} \circ u_i = u_{i-1} \circ d_i, \quad i = 1, \dots, m-1, \\ d_1 \circ u_0 = 0.$$

The latter is called the *dead-end relation*. Given two paths  $p, p' \in Q_m$  we write  $p'p$  instead of  $p' \circ p$ . The algebra  $Q_m$  inherits the grading  $l(\cdot)$  from  $P_m$  since all the relations are homogeneous. We call  $Q_m$  for short *KS  $m$ -quiver algebra*.  $\blacktriangle$

We denote, by abuse of notation, the path of length 0 that starts and ends at  $\mathbf{i}$  also by  $\mathbf{i}$ . Note that the  $\mathbf{i}$  are projectors or idempotents, because  $\mathbf{i}\mathbf{i} = \mathbf{i}$ ,  $p\mathbf{i} = p$  if  $p$  starts in  $\mathbf{i}$  and 0 else and  $\mathbf{i}p = p$  if  $p$  ends in  $\mathbf{i}$  and 0 else. Moreover, they form a complete set of pairwise orthogonal idempotents, that is  $1 = \mathbf{0} + \mathbf{1} + \dots + \mathbf{m}$  and  $\mathbf{i}\mathbf{j} = \delta(\mathbf{i}, \mathbf{j})$ , where  $1 \in Q_m$  is the unit. Note that  $0 \neq \mathbf{0}$ ,  $1 \neq \mathbf{1}$  and the  $\mathbf{i}$ 's are not central for  $m > 0$ , since e.g.  $0 = \mathbf{i}u_i \neq u_i\mathbf{i} = u_i$  for  $i = 0, \dots, m-1$ .

Moreover, we denote for  $i = 1, \dots, m$  by  $\varepsilon_i = u_{i-1}d_i$  the loop that starts at  $\mathbf{i}$  and goes via  $d_i$  to  $\mathbf{i}-1$  and then back via  $u_{i-1}$ . Note that the relations imply that  $\varepsilon_i = d_{i+1}u_i$  (if possible, i.e. if  $i+1 \leq m$ ). Thus, the  $\mathbb{Q}(q)$ -algebra  $Q_m$  has a basis given by  $\mathbf{i}$  (for  $i = 0, \dots, m$ ) and  $u_i$  (for  $i = 0, \dots, m-1$ ) and  $d_i, \varepsilon_i$  (for  $i = 1, \dots, m$ ) with  $l(\mathbf{i}) = 0, l(u_i) = l(d_i) = 1$  and  $l(\varepsilon_i) = 2$ .

We call an algebra homomorphism  $f: A \rightarrow B$  between graded algebras  $A$  and  $B$  a *homomorphism of graded algebras*, if  $f(A^k) \subset B^k$  for all  $k \in \mathbb{Z}$ . We have the following.

**Lemma 3.2.** There is a sequence of (non-unital!) inclusions of graded algebras

$$Q_0 \xhookrightarrow{\iota_0} Q_1 \xhookrightarrow{\iota_1} Q_2 \xhookrightarrow{\iota_2} \dots,$$

where  $\iota_m: Q_m \rightarrow Q_{m+1}$  is defined by  $\mathbf{i}, u_i, d_i, \varepsilon_i \mapsto \mathbf{i}, u_i, d_i, \varepsilon_i$  for all suitable indices  $i$ .  $\square$

*Proof.* This follows because  $P_m$  includes into  $P_{m+1}$  and the set of relations for  $Q_m$  is included in the ones for  $Q_{m+1}$ . That these morphisms respect the grading and are injective is immediate.  $\blacksquare$

This motivates the following definition.

**Definition 3.3. (Khovanov-Seidel's  $\infty$ -quiver algebra)** Define  $Q_\infty$  to be the inductive limit of the sequence of inclusions of graded algebras from Lemma 3.2, that is  $Q_\infty = \varinjlim Q_m$ . We call it for short *KS  $\infty$ -quiver algebra*.  $\blacktriangle$

Note that  $Q_\infty$  is a graded  $\mathbb{Q}(q)$ -vector space of countable dimension. Moreover,  $Q_\infty$  is an algebra with a complete set of pairwise orthogonal idempotents  $\{\mathbf{i} \mid i \in \mathbb{Z}_{\geq 0}\}$ , but  $Q_\infty$  is a *non-unital* algebra, since the unit would have to be an infinite sum of the  $\mathbf{i}$ 's. Such an algebra is sometimes called *idempotent*.

**Example 3.4.**  $Q_0$  consists just of  $\mathbb{Q}(q)$ -multiples of  $\mathbf{0}$ . The algebra  $Q_{m>0}$  can be visualized as

$$\begin{array}{ccccccc} \overset{\varepsilon_m}{\curvearrowright} & & \overset{\varepsilon_i}{\curvearrowright} & & \overset{\varepsilon_2}{\curvearrowright} & & \overset{\varepsilon_1}{\curvearrowright} \\ \bullet & \xleftarrow{u_{m-1}} & \bullet & \xleftarrow{u_{i-1}} & \bullet & \xleftarrow{u_1} & \bullet \\ \mathbf{m} & \xleftarrow{d_m} & \mathbf{i} & \xleftarrow{d_i} & \mathbf{2} & \xleftarrow{d_2} & \mathbf{1} \\ & & & & & & \xleftarrow{d_1} & \mathbf{0} \end{array}$$

The KS  $\infty$ -quiver algebra  $Q_\infty$  can be visualized as

$$\dots \xleftarrow{u_i} \bullet \xleftarrow{d_{i+1}} \mathbf{i} \xleftarrow{d_i} \bullet \xleftarrow{u_{i-1}} \dots \xleftarrow{u_2} \bullet \xleftarrow{d_3} \mathbf{2} \xleftarrow{d_2} \bullet \xleftarrow{u_1} \bullet \xleftarrow{d_1} \mathbf{1} \xleftarrow{u_0} \bullet \xleftarrow{d_1} \mathbf{0}$$

We point out that  $Q_\infty$  only has one asymmetry coming from the dead-end relation. Moreover,  $Q_\infty$  is graded by the path length  $l(\cdot)$  due to the fact that  $Q_\infty$  does not contain infinite paths.  $\blacktriangle$

In order to be able to also consider the semisimple blocks  $\mathfrak{T}_{-1}$  and  $\mathfrak{T}_{l-1}$  of our category  $\mathfrak{T}$ , we also introduce another quotient of the path algebra  $P_m$ , denoted by  $Q_m^{\text{triv}}$ , (and take a limit as above). Since the corresponding module categories should be semisimple, the quotient  $Q_m^{\text{triv}}$  is rather trivial and we call it *KS trivial  $m$ -quiver algebra*.

**Definition 3.5. (Khovanov-Seidel's trivial  $m$ -quiver algebra)** Let  $Q_m^{\text{triv}}$  denote the quotient algebra obtained from the path algebra  $P_m$  for the quiver from (12) by the defining relations

$$u_i = 0 = d_{i+1}, \quad i = 0, \dots, m-1.$$

The algebra  $Q_m^{\text{triv}}$  inherits the grading  $l(\cdot)$  from  $P_m$ , but this grading is trivial.  $Q_m^{\text{triv}}$  consists only of orthogonal idempotents  $\mathbf{i}$  for  $i = 0, \dots, m$ . These idempotents form a set of pairwise non-isomorphic, central, orthogonal idempotents which shows that  $Q_m^{\text{triv}}$  is a semisimple algebra. Moreover, the algebra  $Q_m^{\text{triv}}$  is clearly isomorphic to  $\mathbb{Q}(q) \times \dots \times \mathbb{Q}(q)$  (with  $m+1$  factors).

As before we define *Khovanov-Seidel's trivial  $\infty$ -quiver algebra* via  $Q_\infty^{\text{triv}} = \varinjlim Q_m^{\text{triv}}$ . We note that this can be visualized as

$$\cdots \quad \bullet \quad \cdots \quad \bullet \quad \bullet \quad \bullet$$

$$\mathbf{i} \quad \mathbf{2} \quad \mathbf{1} \quad \mathbf{0}$$

where we take the inductive limit as above.  $\blacktriangle$

For convenience we set  $u_m = d_0 = \varepsilon_0 = 0$  for all  $Q_m$  and  $d_0 = \varepsilon_0 = 0$  for  $Q_\infty$  in the following.

**3.2. Combinatorics of the graded, right  $Q_m$ - and  $Q_\infty$ -modules.** Recall that, if  $A$  denotes some graded  $\mathbb{Q}(q)$ -algebra, then a (right)  $A$ -module  $M$  is called  *$\mathbb{Z}$ -graded* (or simply *graded*), if

$$M = \bigoplus_{k \in \mathbb{Z}} M^k \quad \text{and} \quad M^k \cdot A^{k'} \subset M^{k+k'}.$$

An  $A$ -module homomorphism between graded modules  $f: M \rightarrow N$  is called *degree preserving*, if  $f(M^k) \subset N^k$  for all  $k \in \mathbb{Z}$  and *homogeneous (of degree  $d \in \mathbb{Z}$ )* if  $f(M^k) \subset N^{k+d}$  for all  $k \in \mathbb{Z}$ . We denote by  $\mathbf{Mod}_{\text{gr}}-A$  the category of *graded*, finitely generated  $A$ -modules whose morphisms from  $M$  to  $M'$  are given by

$$(13) \quad \mathbf{Hom}_{\mathbf{Mod}_{\text{gr}}-A}(M, M') = \bigoplus_{s \in \mathbb{Z}} \mathbf{Hom}_A(M, M'\langle s \rangle)_0,$$

where the zero should mean *degree preserving* morphisms and  $\langle s \rangle$  denotes a shift as below. Thus, all morphisms in  $\mathbf{Mod}_{\text{gr}}-A$  are finite direct sums of homogeneous morphisms.

The endofunctor  $\cdot \langle s \rangle: \mathbf{Mod}_{\text{gr}}-A \rightarrow \mathbf{Mod}_{\text{gr}}-A$ , called *shift*<sup>8</sup> by  $s \in \mathbb{Z}$  sends the  $k-s$ -th degree part of a module to the  $k$ -th of the shift  $M \langle s \rangle$ , that is,  $M \langle s \rangle^k = M^{k-s}$ .

We use similar notions for left modules (we denote such categories by e.g.  $A\text{-Mod}_{\text{gr}}$ ) or projective modules (we denote such categories by e.g.  $p\mathbf{Mod}_{\text{gr}}-A$ ). We *only* work in categories of (graded) finitely generated (projective) modules.

$Q_m$  acts on itself from the right by *pre*-composition and from the left by *post*-composition of paths. This makes a difference: let us denote by  $P_i$  the left ideal of  $Q_m$  generated by  $\mathbf{i}$ . Similar,  ${}_i P$  denotes the right ideal generated by  $\mathbf{i}$ . We have as  $\mathbb{Q}(q)$ -vector spaces

$$P_i = \mathbb{Q}(q)\mathbf{i} \oplus \mathbb{Q}(q)u_i \oplus \mathbb{Q}(q)d_i \oplus \mathbb{Q}(q)\varepsilon_i, \quad {}_i P = \mathbb{Q}(q)\mathbf{i} \oplus \mathbb{Q}(q)u_{i-1} \oplus \mathbb{Q}(q)d_{i+1} \oplus \mathbb{Q}(q)\varepsilon_i,$$

<sup>8</sup>In our convention a positive number shifts the degree *up*.

with homogeneous components of degree 0, 1, 1, 2 (from left to right).

The  $P_i$  and the  ${}_iP$  are graded  $Q_m$ -modules (left and right respectively) that can be visualized as

$$P_i = \cdots \xleftarrow{u_i} \underset{\mathbf{i}}{\bullet} \xrightarrow{d_i} \cdots, \quad {}_iP = \cdots \xrightarrow{d_{i+1}} \underset{\mathbf{i}}{\bullet} \xleftarrow{u_{i-1}} \cdots.$$

Thus, the  $P_i$ 's and the  ${}_iP$ 's are projective, since we have (as left, respectively right,  $Q_m$ -modules)

$$Q_m = \bigoplus_{i=0}^m P_i, \quad Q_m = \bigoplus_{i=0}^m {}_iP.$$

Moreover, they are all indecomposable because they are the projective covers of the simple left, respectively right,  $Q_m$ -modules  $L_i$  and  ${}_iL$  obtained from  $P_i$  and  ${}_iP$  by killing  $u_i, d_i$  and  $\varepsilon_i$  respectively  $u_{i-1}, d_{i+1}$  and  $\varepsilon_i$ . Furthermore, it is easy to see that all indecomposable left, respectively right,  $Q_m$ -modules are of the form  $P_i\langle s \rangle$ , respectively  ${}_iP\langle s \rangle$ , for some  $s \in \mathbb{Z}$ : this follows directly from the fact that  $Q_m$  is finite-dimensional. Thus, all indecomposable projective  $Q_m$ -modules are direct summands of  $Q_m$  considered as a (left or right)  $Q_m$ -module.

**Example 3.6.** One easily checks that the same is true for the corresponding notions for  $Q_\infty$  and that one gets a decomposition into  ${}_iP$ 's as follows (we have indicated the neighbouring  ${}_iP$ 's using alternating colors and we for simplicity assume that the  $i$  below is odd)

$$\cdots \xleftarrow{u_i} \underset{\mathbf{i}}{\bullet} \xrightarrow{d_i} \cdots \xleftarrow{u_2} \underset{\mathbf{2}}{\bullet} \xrightarrow{d_2} \cdots \xleftarrow{u_1} \underset{\mathbf{1}}{\bullet} \xrightarrow{d_1} \cdots \xleftarrow{u_0} \underset{\mathbf{0}}{\bullet}$$

We encourage the reader to draw the decomposition into  $P_i$ 's. Again, all finitely generated, graded projective, indecomposable right  $Q_\infty$ -modules are, up to a shift, of the form  ${}_iP$ . Same for the left modules and the  $P_i$ 's. This can be deduced directly, but is true in more generality for idempotented algebras, see for example [34, Proposition 5.3.1].  $\blacktriangle$

Similarly for  $Q_m^{\text{triv}}$  and  $Q_\infty^{\text{triv}}$  which decompose into the corresponding (left and right) modules denoted by  $P_i^{\text{triv}}$  and  ${}_iP^{\text{triv}}$ .

**3.3. Endofunctors on  $p\text{Mod}_{\text{gr}}\text{-}Q_m$  and  $p\text{Mod}_{\text{gr}}\text{-}Q_\infty$ .** Set<sup>9</sup>  $B_i = P_i \otimes_{\mathbb{Q}(q)} {}_iP\langle -1 \rangle$  for all indices  $i = 1, \dots, m$ . Note that the  $B_i$ 's are graded  $Q_m$ -bimodules with the tensor product  $p \otimes p'$  of degree  $l(p \otimes p') = l(p) + l(p')$  for  $p$  of degree  $l(p)$  and  $p'$  of degree  $l(p')$ . We define functors

$$\mathcal{U}_i: p\text{Mod}_{\text{gr}}\text{-}Q_m \rightarrow p\text{Mod}_{\text{gr}}\text{-}Q_m, \quad \mathcal{U}_i = \cdot \otimes_{Q_m} B_i \quad \text{for } i = 1, \dots, m.$$

Note that we have

$$(14) \quad {}_{i'}P \otimes_{Q_m} P_i \cong \begin{cases} \mathbb{Q}(q)\mathbf{i} \oplus \mathbb{Q}(q)\varepsilon_i, & \text{if } |i - i'| = 0, \\ \mathbb{Q}(q)u_i, & \text{if } i' - i = 1, \\ \mathbb{Q}(q)d_i, & \text{if } i - i' = 1, \\ 0, & \text{if } |i - i'| > 1. \end{cases}$$

This can be easily seen by considering (here  $i = i'$  as an example)

$$\cdots \xrightarrow{d_{i+1}} \underset{\mathbf{i}}{\bullet} \xleftarrow{u_{i-1}} \cdots \otimes_{Q_m} \cdots \xleftarrow{u_i} \underset{\mathbf{i}}{\bullet} \xrightarrow{d_i} \cdots,$$

<sup>9</sup>Note that we use a different convention than Khovanov and Seidel for the gradings by shifting  ${}_iP$  down by one.

where we have illustrated the overlapping pieces of  ${}_iP$  and  $P_i$ . This clearly implies

$$(15) \quad \mathcal{U}_i({}_{i'}P) \cong \begin{cases} {}_iP\langle -1 \rangle \oplus {}_iP\langle +1 \rangle, & \text{if } |i - i'| = 0, \\ {}_iP, & \text{if } |i - i'| = 1, \\ 0, & \text{if } |i - i'| > 1. \end{cases}$$

We note that we can see  ${}_{i'}P \otimes_{Q_m} P_i$  as a graded, right  $Q_m^{\text{triv}}$ -module where the action of  $\mathbf{i}$  kills everything that does not start in  $\mathbf{i}$ . Note that, in this notation,  $\mathbb{Q}(q)\mathbf{i}$ ,  $\mathbb{Q}(q)u_i$ ,  $\mathbb{Q}(q)d_i$  and  $\mathbb{Q}(q)\varepsilon_i$  are all one dimensional  $Q_m^{\text{triv}}$ -modules concentrated in degrees 0, 1, 1 and 2 respectively. Hence, as graded, right  $Q_m^{\text{triv}}$ -modules,  $\mathbb{Q}(q)u_i \cong \mathbb{Q}(q)\mathbf{i}\langle +1 \rangle$ ,  $\mathbb{Q}(q)d_i \cong \mathbb{Q}(q)\mathbf{i}\langle +1 \rangle$  and  $\mathbb{Q}(q)\varepsilon_i \cong \mathbb{Q}(q)\mathbf{i}\langle +2 \rangle$ .

**Corollary 3.7.** The functors  $\mathcal{U}_i: p\text{Mod}_{\text{gr-}Q_m} \rightarrow p\text{Mod}_{\text{gr-}Q_m}$  satisfy the following.

- (a)  $\mathcal{U}_i \circ \mathcal{U}_i \cong \mathcal{U}_i\langle -1 \rangle \oplus \mathcal{U}_i\langle +1 \rangle$  for  $i = 1, \dots, m$ .
- (b) Let  $i' = i \pm 1$  such that  $i, i' \in \{1, \dots, m\}$ . Then  $\mathcal{U}_i \circ \mathcal{U}_{i'} \circ \mathcal{U}_i \cong \mathcal{U}_i$ .
- (c)  $\mathcal{U}_i \circ \mathcal{U}_{i'} \cong 0$ , if  $|i - i'| > 1$ . □

*Proof.* This follows directly from (15). ■

Finally we set

$$\mathcal{U}_{\text{even}} = \bigoplus_{1 \leq i, 2i \leq m} \mathcal{U}_{2i}, \quad \mathcal{U}_{\text{odd}} = \bigoplus_{0 \leq i, 2i+1 \leq m} \mathcal{U}_{2i+1}.$$

By Corollary 3.7 we see that

$$(16) \quad \mathcal{U}_{\text{even}} \circ \mathcal{U}_{\text{even}} \cong \mathcal{U}_{\text{even}}\langle -1 \rangle \oplus \mathcal{U}_{\text{even}}\langle +1 \rangle, \quad \mathcal{U}_{\text{odd}} \circ \mathcal{U}_{\text{odd}} \cong \mathcal{U}_{\text{odd}}\langle -1 \rangle \oplus \mathcal{U}_{\text{odd}}\langle +1 \rangle.$$

It is clear that we can easily adapt the definition of the  $\mathcal{U}_i$ 's to the  $Q_\infty$  case. We denote these functors by  $\mathcal{U}_i^\infty$  for all  $i \in \mathbb{Z}_{>0}$ . These functors satisfy completely similar relations as before.

We also define  $\mathcal{U}_{\text{even}}^\infty$  and  $\mathcal{U}_{\text{odd}}^\infty$  completely analogously by taking the direct sum over all  $i \in \mathbb{Z}_{>0}$ . The reader is still invited to check that these two satisfy similar relations as in (16).

We also refine the definitions of the functors  $\mathcal{U}_i$  by *factoring through* the category of graded (right)  $Q_m^{\text{triv}}$ -modules which we denote by  $\text{Mod}_{\text{gr-}Q_m^{\text{triv}}}$ . To be precise, we define  $\mathcal{U}_i^t$  and  $\mathcal{U}_i^t$  via

$$\begin{aligned} \mathcal{U}_i^t: \text{Mod}_{\text{gr-}Q_m} &\rightarrow \text{Mod}_{\text{gr-}Q_m^{\text{triv}}}, \quad \mathcal{U}_i^t = \cdot \otimes_{Q_m} P_i \\ \mathcal{U}_i^i: \text{Mod}_{\text{gr-}Q_m^{\text{triv}}} &\rightarrow \text{Mod}_{\text{gr-}Q_m}, \quad \mathcal{U}_i^i = \cdot \otimes_{\mathbb{Q}(q)} {}_iP\langle -1 \rangle. \end{aligned}$$

It is immediate that  $\mathcal{U}_i = \mathcal{U}_i^i \circ \mathcal{U}_i^t$ . We define even and odd versions of these refinements as before where we use  $\mathcal{U}_{\text{even}}^t$  and  $\mathcal{U}_{\text{even}}^{\text{even}}$  as notations (similar for the odd versions).

The following lemma can be seen, by Remark 3.16 below, as an analog of [57, Theorem 8.4].

**Lemma 3.8.** As graded functors:  $\mathcal{U}_i^t\langle +1 \rangle$  is the right adjoint of  $\mathcal{U}_i^i$ ,  $\mathcal{U}_i^i$  is the left adjoint of  $\mathcal{U}_i^t\langle -1 \rangle$ . Similar for the even/odd versions. The functors  $\mathcal{U}_i$ ,  $\mathcal{U}_{\text{even}}$  and  $\mathcal{U}_{\text{odd}}$  are all graded self adjoint. □

*Proof.* This is a case-by-case check. We use that, as graded  $\mathbb{Q}(q)$ -vector spaces, we have

$$(17) \quad \text{Hom}_{p\text{Mod}_{\text{gr-}Q_m}}({}_iP, {}_{i'}P) \cong \begin{cases} \mathbb{Q}(q)\mathbf{i} \oplus \mathbb{Q}(q)\varepsilon_i, & \text{if } |i - i'| = 0, \\ \mathbb{Q}(q)u_i, & \text{if } i' - i = 1, \\ \mathbb{Q}(q)d_i, & \text{if } i - i' = 1, \\ 0, & \text{if } |i - i'| > 1. \end{cases}$$

The isomorphism is given by mapping a path  $p$  on the right-hand side to the homomorphism  ${}_iP \rightarrow {}_{i'}P$  given by left multiplication (*post-composition*) with  $p$ . Note that this is a homogeneous morphism of degree  $l(p)$ .

We only prove that  $\mathcal{U}_i^t\langle +1 \rangle$  is the right adjoint of  $\mathcal{U}_i^i$  and leave the rest to the reader. To this end, we have to show that there are isomorphisms of graded vector spaces

$$\mathrm{Hom}_{p\mathrm{Mod}_{\mathrm{gr}\text{-}Q_m}}(\mathcal{U}_i^i(\mathbb{Q}(q)\mathbf{i}), {}_{i'}P) \cong \mathrm{Hom}_{p\mathrm{Mod}_{\mathrm{gr}\text{-}Q_m^{\mathrm{triv}}}}(\mathbb{Q}(q)\mathbf{i}, \mathcal{U}_i^t\langle +1 \rangle({}_{i'}P)),$$

where we can restrict to check only for objects as above by additivity. Note that we have three cases depending on  $i - i'$ , since the case  $|i - i'| > 1$  is clear.

$i = i'$ . The left-hand side is  $\mathrm{Hom}_{p\mathrm{Mod}_{\mathrm{gr}\text{-}Q_m}}({}_iP\langle -1 \rangle, {}_iP) \cong \mathbb{Q}(q)\mathbf{i}\langle +1 \rangle \oplus \mathbb{Q}(q)\varepsilon_i\langle +1 \rangle$ , which follows from (17). Moreover, by (14) and the shift by  $+1$ , we get the same for the right side.

$i' = i + 1$ . The left-hand side gives  $\mathrm{Hom}_{p\mathrm{Mod}_{\mathrm{gr}\text{-}Q_m}}({}_iP\langle -1 \rangle, {}_{i+1}P) \cong \mathbb{Q}(q)u_i\langle +1 \rangle$ . This follows again by (17). The right-hand side gives, by (14) and the shift by  $+1$ , the same result.

$i' = i - 1$ . Similarly to the case  $i' = i + 1$ .

Thus, we have an adjoint pair  $(\mathcal{U}_i^i, \mathcal{U}_i^t\langle +1 \rangle)$ . The other statements follow analogously.  $\blacksquare$

The same holds, *mutatis mutandis*, for the infinity versions as well.

**3.4.  $Q_\infty$  and the tilting category  $\mathfrak{T}$ .** Recall that the category  $\mathfrak{T}_\lambda$  denotes the  $\lambda$ -block of  $\mathfrak{T}$  for  $\lambda$  in the fundamental alcove  $\mathcal{A}_0$ , see Subsection 2.4. We fix any such  $\lambda$  and denote everything using the simplified notation without the  $\lambda$ 's. In particular, recall our notation from Definition 2.25 for the tilting generators  $T_q(\infty)$  and  $T_q(\leq \mathbf{m})$ . We denote by  $\mathfrak{T}_\lambda(\leq \mathbf{m})$  the full subcategory of  $\mathfrak{T}_\lambda$  consisting of objects whose indecomposable summands are all from the set  $\{T_q(\lambda_0), \dots, T_q(\lambda_m)\}$  for some fixed  $m \in \mathbb{Z}_{\geq 0}$ . We also use completely similar notations for the walls  $\mu$  by indicating this case with a superscript  $t$ .

**Proposition 3.9.** We have

$$\mathrm{End}_{\mathbf{U}_q}(T_q(\leq \mathbf{m})) \cong Q_m \quad \text{and} \quad \mathrm{End}_{\mathbf{U}_q}(T_q(\leq \mathbf{m})^t) \cong Q_m^{\mathrm{triv}},$$

which are isomorphisms of  $\mathbb{Q}(q)$ -algebras.  $\square$

*Proof.* We are going to construct these isomorphisms explicitly. Moreover, if we simply write  $\mathbf{i}$  for  $T_q(\mathbf{i})$ , then we can visualize  $\mathrm{End}_{\mathbf{U}_q}(T_q(\leq \mathbf{m}))$  using Proposition 2.30 for all  $m > 0$  as

$$\begin{array}{ccccccc} \overset{\varepsilon_m}{\curvearrowright} & & \overset{\varepsilon_i}{\curvearrowright} & & \overset{\varepsilon_2}{\curvearrowright} & & \overset{\varepsilon_1}{\curvearrowright} \\ \bullet & \xleftarrow{u_{m-1}} & \bullet & \xleftarrow{u_{i-1}} & \bullet & \xleftarrow{u_1} & \bullet \\ \mathbf{m} & \xrightarrow{d_m} & \mathbf{i} & \xrightarrow{d_i} & \mathbf{2} & \xrightarrow{d_2} & \mathbf{1} & \xrightarrow{d_1} & \mathbf{0} \end{array}$$

Thus, we consider the (by Proposition 2.30 well-defined)  $\mathbb{Q}(q)$ -algebra homomorphism

$$\phi: Q_m \rightarrow \mathrm{End}_{\mathbf{U}_q}(T_q(\leq \mathbf{m})), u_i \mapsto u_i, d_i \mapsto d_i, \varepsilon_i \mapsto \varepsilon_i$$

for all suitable indices  $i$ . Using Corollary 2.31 we see that this is an isomorphism. The case  $m = 0$  and the ‘‘trivial case’’ cases are immediate which proves the statement.  $\blacksquare$

The morphisms of  $\mathrm{End}_{\mathbf{U}_q}(T_q(\infty))$  are ‘‘matrices’’  $f = \prod_{i, i' \in \mathbb{Z}_{\geq 0}} f_{i'i}$  with  $f_{i'i}: T_q(\mathbf{i}) \rightarrow T_q(\mathbf{i}')$  and each row consists only of finitely many non-zero entries (this follows from Corollary 2.31). Now  $\mathrm{End}_{\mathbf{U}_q}^{\mathrm{fs}}(T_q(\infty))$  should be the (non-unital) subalgebra of  $\mathrm{End}_{\mathbf{U}_q}(T_q(\infty))$  of all matrices with only finitely many non-zero rows, i.e.

$$\mathrm{End}_{\mathbf{U}_q}^{\mathrm{fs}}(T_q(\infty)) \cong \bigoplus_{i, i'=0}^{\infty} \mathrm{Hom}_{\mathbf{U}_q}(T_q(\mathbf{i}), T_q(\mathbf{i}')).$$

Similarly, of course, in the ‘‘trivial’’ case.

**Proposition 3.10.** We have

$$\begin{aligned}\mathrm{End}_{\mathbf{U}_q}^{\mathrm{fs}}(T_q(\infty)) &\cong \bigoplus_{i,i'=0}^{\infty} \mathrm{Hom}_{\mathbf{U}_q}(T_q(\mathbf{i}), T_q(\mathbf{i}')) \cong Q_{\infty}, \\ \mathrm{End}_{\mathbf{U}_q}^{\mathrm{fs}}(T_q(\infty)^t) &\cong \bigoplus_{i,i'=0}^{\infty} \mathrm{Hom}_{\mathbf{U}_q}(T_q(\mathbf{i})^t, T_q(\mathbf{i}')^t) \cong Q_{\infty}^{\mathrm{triv}},\end{aligned}$$

which are isomorphisms of  $\mathbb{Q}(q)$ -algebras.  $\square$

*Proof.* We only show the first isomorphism since the other is clear. By using Corollary 2.31 and the definition of  $\mathrm{End}_{\mathbf{U}_q}^{\mathrm{fs}}(T_q(\infty))$  from above we see that, for each  $f \in \mathrm{End}_{\mathbf{U}_q}^{\mathrm{fs}}(T_q(\infty))$ , there exists some  $m \in \mathbb{Z}_{\geq 0}$  such that  $f_{i'i} = 0$  for  $i, i' > m$ . Those matrices describe elements in  $\mathrm{End}_{\mathbf{U}_q}(T_q(\leq \mathbf{m}))$  by “forgetting” the parts for  $i, i' > m$ . Thus, we have

$$\mathrm{End}_{\mathbf{U}_q}^{\mathrm{fs}}(T_q(\infty)) \cong \varinjlim \mathrm{End}_{\mathbf{U}_q}(T_q(\leq \mathbf{m})).$$

By Proposition 3.9 we see that this implies

$$\mathrm{End}_{\mathbf{U}_q}^{\mathrm{fs}}(T_q(\infty)) \cong \varinjlim Q_m \cong Q_{\infty}.$$

This finishes the proof.  $\blacksquare$

We are now able to relate  $\mathfrak{T}_{\lambda}(\leq \mathbf{m})$  to  $p\mathrm{Mod}\text{-}Q_m$  and thus,  $\mathfrak{T}_{\lambda}$  to  $p\mathrm{Mod}\text{-}Q_{\infty}$ . We define

$$\begin{aligned}\mathbb{T}_m: \mathfrak{T}_{\lambda}(\leq \mathbf{m}) &\rightarrow \mathrm{Mod}\text{-}Q_m, \mathbb{T}_m(M) = \mathrm{Hom}_{\mathbf{U}_q}(T_q(\leq \mathbf{m}), M), \\ \mathbb{T}_{\infty}: \mathfrak{T}_{\lambda} &\rightarrow \mathrm{Mod}\text{-}Q_{\infty}, \mathbb{T}_{\infty}(M) = \mathrm{Hom}_{\mathbf{U}_q}^{\mathrm{fs}}(T_q(\infty), M) \cong \bigoplus_{i=0}^{\infty} \mathrm{Hom}_{\mathbf{U}_q}(T_q(\mathbf{i}), M),\end{aligned}$$

for  $M$  in either  $\mathrm{Ob}(\mathfrak{T}(\leq \mathbf{m}))$  or  $\mathrm{Ob}(\mathfrak{T}_{\lambda})$  respectively where the isomorphism follows from Proposition 3.10. Similarly for the walls  $\mu$  where we indicate the functors  $\mathbb{T}_m^t$  and  $\mathbb{T}_{\infty}^t$  (and everything else) with superscripts  $t$ . We note that the hom-spaces above are right  $Q_m$ -modules (or  $Q_{\infty}$ ,  $Q_m^{\mathrm{triv}}$  or  $Q_{\infty}^{\mathrm{triv}}$ -modules) by *pre*-composition.

Note that  $\Theta_s, \Theta_t \in \mathrm{Ob}(\mathrm{End}(\mathfrak{T}_{\lambda}))$  from Definition 2.33 clearly descent to  $\mathfrak{T}_{\lambda}(\leq \mathbf{m})$  for all  $m \in \mathbb{Z}_{\geq 0}$ . We denote these restrictions, by abuse of notation, also by  $\Theta_s, \Theta_t$ . Furthermore, recall the notation  $\Theta_{s \text{ or } t}^i$  for  $i \in \mathbb{Z}_{>0}$  which are defined via ( $p_i$  projects to the  $T_q(\mathbf{i})$ -part)

$$\Theta_{s \text{ or } t}^i = \begin{cases} p_{\mathbf{i}} \circ \Theta_s, & \text{if } i \text{ is even,} \\ p_{\mathbf{i}} \circ \Theta_t, & \text{if } i \text{ is odd.} \end{cases}$$

We use the same conventions and notations in the finite case by killing everything above  $m$ .

Similarly: the functors  $\mathcal{T}_{\lambda}^{\mu}$  and  $\mathcal{T}_{\mu}^{\lambda}$  from Definition 2.32 also descent to the finite case where we again denote them by the same symbols.

We consider the right side for the tilting embedding theorem (finite and infinite) as ungraded modules/functors. Moreover  $p\mathrm{Mod}$  always denotes categories of projective modules.

**Theorem 3.11. (Tilting embedding theorem - finite version)** We have the following.

- (a) The functor  $\mathbb{T}_m$  is fully faithful.
- (b) The functor  $\mathbb{T}_m$  sends objects  $M \in \mathrm{Ob}(\mathfrak{T}_{\lambda}(\leq \mathbf{m}))$  to projective  $Q_m$ -modules and is an equivalence between  $\mathfrak{T}_{\lambda}(\leq \mathbf{m})$  and  $p\mathrm{Mod}\text{-}Q_m$ .

(c) We have the following commuting diagram.

$$\begin{array}{ccc} \mathfrak{T}_\lambda(\leq \mathbf{m}) & \xrightarrow{\mathbb{T}_m} & p\text{Mod-}Q_m \\ \Theta_{s \text{ or } t}^i \downarrow & & \downarrow \mathcal{U}_i \\ \mathfrak{T}_\lambda(\leq \mathbf{m}) & \xrightarrow{\mathbb{T}_m} & p\text{Mod-}Q_m. \end{array}$$

(d) We have the following commuting diagrams.

$$\begin{array}{ccc} \mathfrak{T}_\lambda(\leq \mathbf{m}) & \xrightarrow{\mathbb{T}_m} & p\text{Mod-}Q_m \\ \Theta_s \downarrow & & \downarrow \mathcal{U}_{\text{even}} \\ \mathfrak{T}_\lambda(\leq \mathbf{m}) & \xrightarrow{\mathbb{T}_m} & p\text{Mod-}Q_m \end{array} \quad \text{and} \quad \begin{array}{ccc} \mathfrak{T}_\lambda(\leq \mathbf{m}) & \xrightarrow{\mathbb{T}_m} & p\text{Mod-}Q_m \\ \Theta_t \downarrow & & \downarrow \mathcal{U}_{\text{odd}} \\ \mathfrak{T}_\lambda(\leq \mathbf{m}) & \xrightarrow{\mathbb{T}_m} & p\text{Mod-}Q_m. \end{array}$$

(e) The same as in (a)+(b) works for the walls  $\mu$  as well by using  $\mathbb{T}_m^t$ .

(f) We have the following commuting diagrams.

$$\begin{array}{ccc} \mathfrak{T}_\lambda(\leq \mathbf{m}) & \xrightarrow{\mathbb{T}_m} & p\text{Mod-}Q_m \\ \mathcal{T}_\lambda^{-1} \downarrow & & \downarrow \mathcal{U}_{\text{even}}^t \\ \mathfrak{T}_{-1}(\leq \mathbf{m}) & \xrightarrow{\mathbb{T}_m^t} & p\text{Mod-}Q_m^{\text{triv}} \end{array} \quad \text{and} \quad \begin{array}{ccc} \mathfrak{T}_\lambda(\leq \mathbf{m}) & \xrightarrow{\mathbb{T}_m} & p\text{Mod-}Q_m \\ \mathcal{T}_\lambda^{t-1} \downarrow & & \downarrow \mathcal{U}_{\text{odd}}^t \\ \mathfrak{T}_{l-1}(\leq \mathbf{m}) & \xrightarrow{\mathbb{T}_m^t} & p\text{Mod-}Q_m^{\text{triv}}. \end{array}$$

(g) We have the following commuting diagrams.

$$\begin{array}{ccc} \mathfrak{T}_{-1}(\leq \mathbf{m}) & \xrightarrow{\mathbb{T}_m^t} & p\text{Mod-}Q_m^{\text{triv}} \\ \mathcal{T}_{-1}^\lambda \downarrow & & \downarrow \mathcal{U}_t^{\text{even}} \\ \mathfrak{T}_\lambda(\leq \mathbf{m}) & \xrightarrow{\mathbb{T}_m} & p\text{Mod-}Q_m \end{array} \quad \text{and} \quad \begin{array}{ccc} \mathfrak{T}_{l-1}(\leq \mathbf{m}) & \xrightarrow{\mathbb{T}_m^t} & p\text{Mod-}Q_m^{\text{triv}} \\ \mathcal{T}_{l-1}^\lambda \downarrow & & \downarrow \mathcal{U}_t^{\text{odd}} \\ \mathfrak{T}_\lambda(\leq \mathbf{m}) & \xrightarrow{\mathbb{T}_m} & p\text{Mod-}Q_m. \end{array} \quad \square$$

*Proof.* We are careless with the indices in the proof and hope that this does not cause confusion. All appearing indices should be such that everything below 0 or above  $m$  is defined to be zero.

(a). By Proposition 2.20 part (c) and Lemma 2.18 part (a) it is enough to verify the statement for  $M = T_q(\mathbf{i})$  for  $i = 0, \dots, m$ . Moreover, by using Corollary 2.31 together with the discussion in Subsection 3.2, we get isomorphisms  $\mathbb{T}_m(T_q(\mathbf{i})) = \text{Hom}_{\mathbb{U}_q}(T_q(\leq \mathbf{m}), T_q(\mathbf{i})) \cong {}_i P$ . Thus,  $\mathbb{T}_m$  is fully faithful.

(b). From (a) by using the discussion in Subsection 3.2.

(c). This follows by combining  $\mathbb{T}_m(T_q(\mathbf{i})) = \text{Hom}_{\mathbb{U}_q}(T_q(\leq \mathbf{m}), T_q(\mathbf{i})) \cong {}_i P$  with (15) and part (c) of Proposition 2.34.

(d). This follows directly from (c) and the definition of  $\mathcal{U}_{\text{even}}$  and  $\mathcal{U}_{\text{odd}}$ .

(e). The ‘‘trivial’’ cases are clear.

(f). We do the left case here. Note that  $\mathbb{T}_m(T_q(\mathbf{i})) \cong {}_i P$ . Thus, using (14), we see that  $\mathcal{U}_t^{\text{even}} \mathbb{T}_m^t$  sends  $T_q(\mathbf{i})$  to  $\mathbb{Q}(q)\mathbf{i} \oplus \mathbb{Q}(q)\varepsilon_i$  for even  $i$  and  $\mathbb{Q}(q)u_{i-1} \oplus \mathbb{Q}(q)d_{i+1}$  for odd  $i$ . This, by the discussion in Subsection 3.3, is isomorphic as right  $Q_m^{\text{triv}}$ -modules to  $\mathbb{Q}(q)\mathbf{i} \oplus \mathbb{Q}(q)\mathbf{i}$  and  $\mathbb{Q}(q)\mathbf{i} - \mathbf{1} \oplus \mathbb{Q}(q)\mathbf{i} + \mathbf{1}$  respectively. In addition,  $\mathcal{T}_\lambda^{-1}$  sends  $T_q(\mathbf{i})$  to  $T_q(\mu_i) \oplus T_q(\mu_i)$  (for  $i$  even) or to  $T_q(\mu_{i-1}) \oplus T_q(\mu_{i+1})$  (for  $i$  odd). These are then sent to  $\mathbb{Q}(q)\mathbf{i} \oplus \mathbb{Q}(q)\mathbf{i}$  (for  $i$  even) respectively  $\mathbb{Q}(q)\mathbf{i} - \mathbf{1} \oplus \mathbb{Q}(q)\mathbf{i} + \mathbf{1}$  (for  $i$  odd).

(g): Analogously to (f). ■



**Theorem 3.12. (Tilting embedding theorem - infinite version)** We have the following.

- (a) The functor  $\mathbb{T}_\infty$  is fully faithful.
- (b) The functor  $\mathbb{T}_\infty$  sends objects  $M \in \text{Ob}(\mathfrak{T})$  to projective  $Q_\infty$ -modules and is an equivalence between  $\mathfrak{T}_\lambda$  and  $p\text{Mod-}Q_\infty$ .
- (c) We have the following commuting diagram.

$$\begin{array}{ccc} \mathfrak{T}_\lambda & \xrightarrow{\mathbb{T}_\infty} & p\text{Mod-}Q_\infty \\ \Theta_{s \text{ or } t}^i \downarrow & & \downarrow U_i^\infty \\ \mathfrak{T}_\lambda & \xrightarrow{\mathbb{T}_\infty} & p\text{Mod-}Q_\infty. \end{array}$$

- (d) We have the following commuting diagrams.

$$\begin{array}{ccc} \mathfrak{T}_\lambda & \xrightarrow{\mathbb{T}_\infty} & p\text{Mod-}Q_\infty \\ \Theta_s \downarrow & & \downarrow U_{\text{even}}^\infty \\ \mathfrak{T}_\lambda & \xrightarrow{\mathbb{T}_\infty} & p\text{Mod-}Q_\infty \end{array} \quad \text{and} \quad \begin{array}{ccc} \mathfrak{T}_\lambda & \xrightarrow{\mathbb{T}_\infty} & p\text{Mod-}Q_\infty \\ \Theta_t \downarrow & & \downarrow U_{\text{odd}}^\infty \\ \mathfrak{T}_\lambda & \xrightarrow{\mathbb{T}_\infty} & p\text{Mod-}Q_\infty. \end{array}$$

- (e) The same as in (a)+(b) works for the walls  $\mu$  as well by using  $\mathbb{T}_\infty^t$ .
- (f) We have the following commuting diagrams.

$$\begin{array}{ccc} \mathfrak{T}_\lambda(\infty) & \xrightarrow{\mathbb{T}_\infty} & p\text{Mod-}Q_\infty \\ \tau_\lambda^{-1} \downarrow & & \downarrow U_{\text{even}}^t \\ \mathfrak{T}_{-1}(\infty) & \xrightarrow{\mathbb{T}_\infty^t} & p\text{Mod-}Q_\infty^{\text{triv}} \end{array} \quad \text{and} \quad \begin{array}{ccc} \mathfrak{T}_\lambda(\infty) & \xrightarrow{\mathbb{T}_\infty} & p\text{Mod-}Q_\infty \\ \tau_\lambda^{t-1} \downarrow & & \downarrow U_{\text{odd}}^t \\ \mathfrak{T}_{l-1}(\infty) & \xrightarrow{\mathbb{T}_\infty^t} & p\text{Mod-}Q_\infty^{\text{triv}}. \end{array}$$

- (g) We have the following commuting diagrams.

$$\begin{array}{ccc} \mathfrak{T}_{-1}(\infty) & \xrightarrow{\mathbb{T}_\infty^t} & p\text{Mod-}Q_\infty^{\text{triv}} \\ \tau_{-1}^\lambda \downarrow & & \downarrow U_t^{\text{even}} \\ \mathfrak{T}_\lambda(\infty) & \xrightarrow{\mathbb{T}_\infty} & p\text{Mod-}Q_\infty \end{array} \quad \text{and} \quad \begin{array}{ccc} \mathfrak{T}_{l-1}(\infty) & \xrightarrow{\mathbb{T}_\infty^t} & p\text{Mod-}Q_\infty^{\text{triv}} \\ \tau_{l-1}^\lambda \downarrow & & \downarrow U_t^{\text{odd}} \\ \mathfrak{T}_\lambda(\infty) & \xrightarrow{\mathbb{T}_\infty} & p\text{Mod-}Q_\infty. \end{array} \quad \square$$

*Proof.* The proofs of (a)-(g) is similar to the proofs given in Theorem 3.11 by using arguments as in Proposition 3.10. We leave it to the reader. ■

**Remark 3.13.** We encourage the reader to work out the translations onto and out of the wall commuting diagrams similar to part (c) of the theorems above. ▲

We note the following corollary for completeness.

**Corollary 3.14.** For all  $\lambda, \lambda' \in \mathcal{A}_0$  we have  $\mathfrak{T}_\lambda \cong \mathfrak{T}_{\lambda'}$ . Thus,

$$\mathfrak{T}(\leq \mathbf{m}) \cong \bigoplus_{i=0}^{l-2} p\text{Mod-}Q_m \oplus \bigoplus_{i=0}^1 p\text{Mod-}Q_m^{\text{triv}}, \quad \mathfrak{T} \cong \bigoplus_{i=0}^{l-2} p\text{Mod-}Q_\infty \oplus \bigoplus_{i=0}^1 p\text{Mod-}Q_\infty^{\text{triv}},$$

with semisimple categories  $p\text{Mod-}Q_m^{\text{triv}}$  and  $p\text{Mod-}Q_\infty^{\text{triv}}$ . □

*Proof.* This follows from Lemma 2.26 and Theorems 3.11 and 3.12 because the right-hand sides are always the same independent of  $\lambda \in \mathcal{A}_0$ .  $\blacksquare$

**Example 3.15. (How to compute the images of the translation functors on  $U_q$ -morphisms)** Combining the commuting diagrams of the Theorems 3.11 and 3.12 we obtain an explicit way to compute  $\Theta_s$  and  $\Theta_t$  not just on the  $T_q(\mathbf{i})$ 's (as we already know by part (c) of Proposition 2.34), but also on the  $U_q$ -intertwiners in  $\text{Hom}_{U_q}(T_q(\mathbf{i}), T_q(\mathbf{i}'))$ .

This follows by using (17) together with  $\Theta_s \rightsquigarrow \mathcal{U}_{\text{even}}$  and  $\Theta_t \rightsquigarrow \mathcal{U}_{\text{odd}}$ . For example, given  $u_0: T_q(\mathbf{0}) \rightarrow T_q(\mathbf{1})$ , we can compute  $\Theta_t(u_0)$  as follows. First note that  $\mathbb{T}_\infty \Theta_t(T_q(\mathbf{0})) \cong {}_1P$  and  $\mathbb{T}_\infty \Theta_t(T_q(\mathbf{1})) \cong {}_1P \oplus {}_1P$  by (15) and Theorem 3.12. By using (17) we see

$$\Theta_t(u_0) = \begin{pmatrix} 0 \\ \text{id} \end{pmatrix} : T_q(\mathbf{1}) \rightarrow T_q(\mathbf{1}) \oplus T_q(\mathbf{1}).$$

We see that this is actually

$$\Theta_t(u_0) = \begin{pmatrix} 0 \\ \text{id} \end{pmatrix} : T_q(\mathbf{1}) \rightarrow T_q(\mathbf{1})\langle -1 \rangle \oplus T_q(\mathbf{1})\langle +1 \rangle,$$

by using the results we are going to explain in Subsection 3.5. Indeed, the grading is very helpful to calculate the images of the  $U_q$ -interwiners, e.g.  $\Theta_t(u_0)$  can only be zero on the first component, since we will show that there will not be suitable  $U_q$ -intertwiners lowering the degree.  $\blacktriangle$

**Remark 3.16.** Let  $\mathfrak{g} = \mathfrak{sl}_{m+1}$  and  $\mathfrak{p} = \mathfrak{p}_1$  be a maximal parabolic subalgebra for  $S_1 \times S_{m-1}$  (for a definition see for example [24, Chapter 9]). Denote by  $\mathcal{O}^{\mathfrak{p}}$  the corresponding parabolic category  $\mathcal{O}$  (for a definition and some properties see e.g. [24, Section 9.3]). Moreover, denote by  $\mathcal{O}_0^{\mathfrak{p}}$  the principle block. As Khovanov and Seidel show in [36, Proposition 2.9] there is an equivalence of categories  $\mathcal{O}_0^{\mathfrak{p}} \cong \text{Mod-}Q_m$ . Thus, by Theorems 3.11 and 3.12, we see that  $\mathfrak{T}_\lambda$  governs  $\mathcal{O}_0^{\mathfrak{p}}$  for all  $m$ . Similarly for the projective endofunctors: as explained in [36, below Proposition 2.9], the functors  $\mathcal{U}_i$  correspond to the translation through the  $i$ -th wall (note that, under the equivalence above, the  $\mathfrak{sl}_{m+1}$  has Weyl group generators  $s_1, \dots, s_m$  and therefore translation functors indexed by  $i = 1, \dots, m$ ). Moreover,  $\mathcal{U}_i^t$  corresponds to the translation onto and  $\mathcal{U}_i^i$  corresponds to the translation out off the wall functors. Hence, by Theorems 3.11 and 3.12, we can say that these are governed by the combinatorics of  $\mathcal{T}_\lambda^\mu$ ,  $\mathcal{T}_\mu^\lambda$  and  $\Theta_{s \text{ or } t}^\lambda$  from our tilting case.

Another point is, as Khovanov and Seidel explain after [36, Proposition 2.9], that the path length grading gives rise to a *Koszul grading* in the sense of [7] on the  $Q_m$ 's, see also [58, Example 1.1]. The same holds for  $Q_\infty$ . This can either be seen “by hand” or by using a more general theory for (quotients of) not necessary finite quiver algebras that can be found for example in [45].  $\blacktriangle$

**Remark 3.17.** Khovanov and Seidel's quiver is also related to Khovanov's arc algebra  $H^m$  (for  $m$  even) that he introduced in [31] to give an algebraic interpretation of Khovanov homology. The arc algebra categorifies the invariant tensors of  $V^{\otimes m}$  where  $V$  is the two dimensional vector representation of  $U_v$ . In addition, together with Chen he extended in [16] this categorification to the full tensor product  $V^{\otimes m}$  by defining a certain subquotient  $\prod_k A^{k, m-k}$  (this quotient can be seen as the quasi-hereditary cover of  $H^m$ ). All of these have a topological interpretation as algebras consisting of cobordisms, see e.g. [16, Section 2], and they are graded by *the Euler characteristic* of these cobordisms. As explained in [16, Section 3], the  $A^{1, m-1}$ -part of this subquotient is graded isomorphic to  $Q_m$ . Thus, we see that  $\mathfrak{T}$  governs  $A^{1, m-1}$  for all  $m$ . Moreover, this gives a hint for a generalization of our work: we think that analogs of the Theorems 3.11 and 3.12 can be proven for certain subquotients of the  $\mathfrak{sl}_n$  generalizations of  $H^m$  studied in e.g. [43], [44], [59] or [60].  $\blacktriangle$

**3.5. The tilting category  $\mathfrak{T}$  and its graded counterpart  $\mathfrak{T}^{\text{gr}}$ .** In this subsection we discuss the consequences of Theorems 3.11 and 3.12 with respect to the question how the path length grading  $l(\cdot)$  (see Definition 3.1) of Khovanov-Seidel's  $\infty$ -quiver algebra relates to the tilting category  $\mathfrak{T}$ . We point out that this is non-trivial since Theorems 3.11 and 3.12 only say that  $\mathfrak{T}_\lambda(\leq \mathbf{m})$  and  $\mathfrak{T}_\lambda$  are isomorphic to subcategories of  $p\text{Mod-}Q_m$  and  $p\text{Mod-}Q_\infty$ .

Recall that, for every graded algebra  $A$ , there is a *forgetful functor*  $\text{forget} : \mathbf{Mod}_{\text{gr-}A} \rightarrow \mathbf{Mod-}A$  that forgets the grading. Using this functor, we say that an  $A$ -module  $M \in \text{Ob}(\mathbf{Mod-}A)$  is *gradable* if there exists an  $A$ -module  $\tilde{M} \in \text{Ob}(\mathbf{Mod}_{\text{gr-}A})$  such that  $\text{forget}(\tilde{M}) = M$ . Note that, by abuse of notation, we usually do not distinguish between  $\tilde{M}$  and  $M$ .

Recall that  $\text{Hom}_{\mathbf{Mod-}A}(M, M')$  consists of all (right)  $A$ -module homomorphisms  $f : M \rightarrow M'$  and  $\text{Hom}_{\mathbf{Mod}_{\text{gr-}A}}(\tilde{M}, \tilde{M}')$  consists of (right)  $A$ -module homomorphisms  $\tilde{f} : \tilde{M} \rightarrow \tilde{M}'$  as in (13). Hence, in the same vein as above, we can call an  $A$ -module homomorphism  $f : M \rightarrow M'$  *gradable*, if there exists  $\tilde{f} : \tilde{M} \rightarrow \tilde{M}'$  such that  $\text{forget}(\tilde{f}) = f$ . Consequently, we define the following.

**Definition 3.18.** We call a (left)  $U_q$ -tilting module  $M \in \text{Ob}(\mathfrak{T})$  *gradable*, if  $\mathbb{T}_\infty(M)$  is gradable viewed as a (right)  $Q_\infty$ -module. We call a  $U_q$ -intertwiner  $f : M \rightarrow M' \in \text{Hom}_{\mathfrak{T}}(M, M')$  *gradable*, if  $\mathbb{T}_\infty(f) : \mathbb{T}_\infty(M) \rightarrow \mathbb{T}_\infty(M')$  is a gradable  $Q_\infty$ -module homomorphism.

We denote by  $\mathfrak{T}^{\text{gr}}$  the subcategory of  $\mathfrak{T}$  consisting of gradable  $U_q$ -tilting modules and gradable  $U_q$ -intertwiners. We use similar notations and conventions for  $\leq \mathbf{m}$  and for fixed  $\lambda$  or  $\mu$ .  $\blacktriangle$

The question concerning which objects  $M \in \text{Ob}(\mathfrak{T})$  are gradable turns out to be surprisingly simple in our case. We note that, with respect to the rather complicated situation for graded category  $\mathcal{O}_0^{\text{p}}$  discussed in e.g. [57, Theorem 4.1], the following proposition is quite remarkable.

**Proposition 3.19.** All objects  $M \in \text{Ob}(\mathfrak{T}_\lambda(\leq \mathbf{m}))$ ,  $M \in \text{Ob}(\mathfrak{T}_\lambda)$  and  $M \in \text{Ob}(\mathfrak{T})$  are gradable. The grading of each indecomposable module  $T_q(\mathbf{i})$  is unique up to shifts.  $\square$

*Proof.* We only prove the  $\infty$  case and leave the other case to the reader. We start by considering  $\lambda \in \mathcal{A}_0$  and discuss the semisimple case on the walls afterwards.

It is easy to check that, for any graded algebra  $A$  and any two gradable  $A$ -modules  $M$  and  $M'$ , the direct sum  $M \oplus M'$  is also gradable. Thus, by Lemma 2.18 part (a), it is enough to consider only the  $T_q(\mathbf{i})$ 's. As in the proof of the part (b) of Theorem 3.12 (or Theorem 3.11 in the finite case) we see that  $\mathbb{T}_\infty(T_q(\mathbf{i})) \cong {}_i P$ . As discussed in Subsection 3.2, the  ${}_i P$  can be given a grading coming from the path length  $l(\cdot)$ . Thus, all the  $T_q(\mathbf{i})$ 's are gradable.

On the walls: Since this is the semisimple case by Lemma 2.26, we can just assign to any simple  $\mathbb{T}_\infty(T_q(\mu_i))$  a degree by demanding that all elements of  $\mathbb{T}_\infty(T_q(\mu_i))$  are concentrated in this particular degree. Thus, all  $T_q(\mu_i)$  are gradable and concentrated in (up to shifts) degree zero.

The uniqueness (up to shifts) can be proven as in [7, Lemma 2.5.3].  $\blacksquare$

**Corollary 3.20.** We have isomorphisms of ungraded categories  $\mathfrak{T}_\lambda(\leq \mathbf{m}) \cong_{\text{iso}} \mathfrak{T}^{\text{gr}}(\leq \mathbf{m})$  and  $\mathfrak{T} \cong_{\text{iso}} \mathfrak{T}^{\text{gr}}$ . That is, also all morphisms are gradable and the gradings are unique up to a shift.  $\square$

*Proof.* As before, for any two gradable  $A$ -homomorphisms  $f$  and  $f'$ , the direct sum  $f \oplus f'$  is also gradable. Thus, by Lemma 2.18 part (a) again together with Proposition 3.19, it is enough to consider only  $\text{Hom}_{\mathbf{U}_q}(T_q(\mathbf{i}), T_q(\mathbf{i}'))$ . By Corollary 2.31 we see that this space has a basis consisting of a subset of  $\mathbf{i}, u_i, d_i$  and  $\varepsilon_i$  (in the non-semisimple case) who are all gradable by Proposition 3.10. The semisimple case and the uniqueness of the grading follow as above. This gives rise to an isomorphism after collapsing the grading of  $\mathfrak{T}^{\text{gr}}$  (since each object  $M$  of  $\mathfrak{T}$  corresponds to objects of  $\mathfrak{T}^{\text{gr}}$  of the form  $M\langle s \rangle$  for  $s \in \mathbb{Z}$ ).  $\blacksquare$

Using Corollary 3.20 and abuse of language, we do not distinguish between  $U_q$ -tilting modules or their graded versions. Moreover, as a consequence of Corollary 3.20, we can choose a *standard grading* (since it will be unique up to shifts) by demanding that simple  $U_q$ -tilting modules are concentrated in degree zero and proceed inductively along the quiver. Note that, by Propositions 2.7 and 2.20 and Corollary 2.8, this gives inductively a graded lift of  $L_q(\mathbf{i})$ ,  $\Delta_q(\mathbf{i})$  and  $\nabla_q(\mathbf{i})$  as well. This choice gives rise to the following graded refinements of Propositions 2.7 and 2.20 and Corollary 2.8.

**Proposition 3.21.** Suppose  $i = al + b$  for some  $a, b \in \mathbb{Z}_{\geq 0}$  with  $b \leq l - 2$ . Set  $i' = (a + 2)l - b - 2$ . Then there exist short exact sequences

$$\begin{aligned} 0 \longrightarrow L_q(i)\langle +1 \rangle \hookrightarrow \Delta_q(i') \twoheadrightarrow L_q(i') \longrightarrow 0, \quad 0 \longrightarrow L_q(i') \hookrightarrow \nabla_q(i') \twoheadrightarrow L_q(i)\langle -1 \rangle \longrightarrow 0, \\ 0 \longrightarrow \Delta_q(i') \hookrightarrow T_q(i') \twoheadrightarrow \Delta_q(i)\langle -1 \rangle \longrightarrow 0, \quad 0 \longrightarrow \nabla_q(i)\langle +1 \rangle \hookrightarrow T_q(i') \twoheadrightarrow \nabla_q(i') \longrightarrow 0. \end{aligned}$$

Moreover, all involved morphisms are degree preserving.  $\square$

*Proof.* This follows from our choice for the grading convention and the degree (under the equivalence in Theorems 3.11 and 3.12) of the morphisms in  $\mathrm{Hom}_{U_q}(T_q(\mathbf{i}), T_q(\mathbf{i}'))$ . To be more precise, we know that the  $T_q(\mathbf{i})$ 's will be, under the functor  $\mathbb{T}_\infty$ , mapped to  ${}_i P$ . Then for example, as explained in Proposition 2.30, the unique morphism

$$T_q(\mathbf{i}) \twoheadrightarrow \nabla_q(\mathbf{i}) \hookrightarrow T_q(\mathbf{i} + \mathbf{1}) \xleftrightarrow{\sim} \bullet_{i+1} \xleftarrow{u_i} \bullet_i$$

is of degree 1. By our convention we see that moving to the left along the KS  $\infty$ -quiver always increases the degree (starting in degree zero for the first simple module). Thus,

$$0 \longrightarrow \nabla_q(i)\langle +1 \rangle \hookrightarrow T_q(i') \twoheadrightarrow \nabla_q(i') \longrightarrow 0.$$

All other cases follow similarly and are left to the reader. Note again that moving to the left along the KS  $\infty$ -quiver always increases the degree, but, by duality, moving right decreases it.  $\blacksquare$

**Remark 3.22.** As we already mentioned in Remark 3.17 the grading induced on  $\mathfrak{T}$  comes from an Euler characteristic on a certain cobordism category associated to Khovanov's arc algebra  $H^m$ . Thus, this is a "natural" grading from the viewpoint of topology.

As we mentioned above, we think that this should generalize in type A. The degree will there be given by an Euler characteristic on a certain "foam" category associated to the  $\mathfrak{sl}_n$ -web algebras which generalize Khovanov's arc algebra. See for example [38], [44], [48] or [60]. Or alternatively, by a grading coming from certain cyclotomic KL-R algebras in the sense of [33] or [50].  $\blacktriangle$

We conclude this section by lifting the translation onto  $\mathcal{T}_\lambda^\mu$ , the translation out of  $\mathcal{T}_\mu^\lambda$  and the translation through the wall  $\Theta_s$  and  $\Theta_t$  to their graded versions (we use the same notation for these). To understand our notation, recall that a category  $\tilde{\mathcal{C}}$  is called a *graded* category, if there exists a functor  $\mathrm{deg}: \tilde{\mathcal{C}} \rightarrow \mathbb{Z}$  where we consider  $\mathbb{Z}$  as a category  $\mathcal{Z}$  with  $\mathrm{Ob}(\mathcal{Z}) = \{\bullet\}$  and  $\mathrm{End}_{\mathcal{Z}}(\bullet) = \mathbb{Z}$ . In addition, there is a  $\mathbb{Z}$ -action  $\langle s \rangle$  on the objects  $O \in \mathrm{Ob}(\tilde{\mathcal{C}})$ , called *shift* by  $s \in \mathbb{Z}$ , such that a given morphism  $f \in \mathrm{Hom}_{\tilde{\mathcal{C}}}(O, O')$  of degree  $d$  is of degree  $d + s' - s$  in  $\mathrm{Hom}_{\tilde{\mathcal{C}}}(O\langle s \rangle, O'\langle s' \rangle)$  (said otherwise, every morphism in  $\tilde{\mathcal{C}}$  has a degree which behaves additively under composition and objects can be shifted via  $\langle s \rangle$ ). Moreover, denote by  $\mathcal{C}$  the *ungraded version*. We say a functor  $\mathcal{F}: \mathcal{C} \rightarrow \mathcal{D}$  is gradable if there exists a *lift*  $\tilde{\mathcal{F}}: \tilde{\mathcal{C}} \rightarrow \tilde{\mathcal{D}}$  such that  $\mathrm{forget} \circ \tilde{\mathcal{F}} = \mathcal{F} \circ \mathrm{forget}$ . We say

that  $\tilde{\mathcal{F}}$  and  $\tilde{\mathcal{F}}'$  are the *same up to a shift*  $s \in \mathbb{Z}$  if there is a natural isomorphism<sup>10</sup> between  $\tilde{\mathcal{F}}$  and  $\tilde{\mathcal{F}}'\langle s \rangle$ . As before, we are usually very careless with our distinction of  $\tilde{\mathcal{F}}$  and  $\mathcal{F}$ .

**Corollary 3.23.** The functors  $\mathcal{T}_\lambda^{\mu,i}, \mathcal{T}_\mu^{\lambda,i}, \mathcal{T}_\lambda^\mu, \mathcal{T}_\mu^\lambda \in \text{Ob}(p\text{End}(\mathfrak{T}(\leq \mathbf{m})))$  are gradable (same in the infinite case). Moreover, any two lifts of  $\mathcal{T}_\lambda^{\mu,i}, \mathcal{T}_\mu^{\lambda,i}$  are the same up to shifts.  $\square$

*Proof.* This follows by Remark 3.13 and the fact that  $\mathcal{U}_i^t$  and  $\mathcal{U}_t^i$  are graded functors (similarly in the  $\infty$  case). The statement for  $\mathcal{T}_\lambda^\mu$  and  $\mathcal{T}_\mu^\lambda$  follows now by (9), since clearly sums of gradable, additive functors in an additive category are gradable. For the infinite case note that any sum (finite or not) of gradable functors is gradable and the claim follows from (9) and the finite case. The uniqueness up to shifts can again be verified as in [7, Lemma 2.5.3], since  $\mathcal{T}_\lambda^{\mu,i}$  and  $\mathcal{T}_\mu^{\lambda,i}$  are indecomposable by Proposition 2.39.  $\blacksquare$

**Corollary 3.24.** The functors  $\Theta_s^{\lambda,i}, \Theta_t^{\lambda,i}, \Theta_s^\lambda, \Theta_t^\lambda \in \text{Ob}(p\text{End}(\mathfrak{T}_\lambda(\leq \mathbf{m})))$  are gradable (same in the infinite case). Moreover, any two lifts of  $\Theta_{s \text{ or } t}^{\lambda,i}$  are the same up to a shift.  $\square$

*Proof.* We can use Corollary 3.23 since all functors involved can be obtained via sums and compositions of the functors  $\mathcal{T}_{\lambda_i}^\mu$  and  $\mathcal{T}_\mu^{\lambda_i}$ . The infinite case follows as above, but using (8) instead of (9). By Proposition 2.38 the functors  $\Theta_{s \text{ or } t}^{\lambda,i}$  are indecomposable and the uniqueness up to shifts follows as before.  $\blacksquare$

We choose the graded versions of  $\mathcal{T}_\lambda^{\mu,i}$  and out of  $\mathcal{T}_\mu^{\lambda,i}$  in the evident way as induced by the gradings on  $\mathcal{U}_i^t$  or  $\mathcal{U}_t^i$ . We get the following refinement of Proposition 2.34.

**Corollary 3.25.** In the graded category  $\mathfrak{T}^{\text{gr}}$  we have for all  $i \in \mathbb{Z}_{\geq 0}$  the following.

- (a) The functors  $\mathcal{T}_\lambda^\mu$  and  $\mathcal{T}_\mu^\lambda$  are well-defined (their definition gives gradable  $\mathbf{U}_q$ -tilting modules in the right blocks), (up to shifts) adjoints (left and right) and exact. Thus,  $\Theta_s^\lambda$  and  $\Theta_t^\lambda$  are exact and graded self-adjoint.
- (b) We have (recalling that  $L_q(\mu_i) \cong T_q(\mu_i)$ )

$$\mathcal{T}_\lambda^\mu(T_q(\lambda_i)) \cong \begin{cases} T_q(\mu_{i-1})\langle +1 \rangle \oplus T_q(\mu_{i+1})\langle +1 \rangle, & \text{if } \mu_i > \lambda_i, \\ T_q(\mu_i) \oplus T_q(\mu_i)\langle +2 \rangle, & \text{if } \mu_i < \lambda_i, \end{cases}$$

$$\mathcal{T}_\mu^\lambda(T_q(\mu_i)) \cong \begin{cases} T_q(\lambda_{i+1})\langle -1 \rangle, & \text{if } \mu_i > \lambda_i, \\ T_q(\lambda_i)\langle -1 \rangle, & \text{if } \mu_i < \lambda_i. \end{cases}$$

- (c) The dead-end relations  $\Theta_s^\lambda(T_q(\lambda_0)) \cong 0$ ,  $\Theta_s^\lambda(T_q(\lambda_1)) \cong T_q(\lambda_2)$  and  $\Theta_t^\lambda(T_q(\lambda_0)) \cong T_q(\lambda_1)$ . Moreover, we have

$$\Theta_{s \text{ or } t}^\lambda(T_q(\lambda_i)) \cong \begin{cases} T_q(\lambda_{i-1}) \oplus T_q(\lambda_{i+1}), & \text{if } i > 1 \text{ is odd for } s \text{ and even for } t, \\ T_q(\lambda_i)\langle -1 \rangle \oplus T_q(\lambda_i)\langle +1 \rangle, & \text{if } i > 0 \text{ is odd for } t \text{ and even for } s. \end{cases}$$

Here we set  $T_q(-1) = T_q(\lambda_{-1}) = T_q(\mu_{-1}) = 0$ .  $\square$

*Proof.* This follows directly from Theorem 3.12 parts (d), (f) and (g) together with (14) and the discussion in Subsection 3.3, for example Lemma 3.8.  $\blacksquare$

<sup>10</sup>In the 2-category where objects are graded categories, where morphisms are graded functors between these categories and where 2-morphisms are graded natural transformations.

**Proposition 3.26.** All functors in  $p\text{End}(\mathfrak{T})$  are gradable. Moreover, the grading is unique up to shifts on the indecomposable projective functors. Similar for  $p\text{End}(\mathfrak{T}_\lambda)$ .  $\square$

*Proof.* The uniqueness, up to shifts, of the grading on the indecomposable factors can be proven as before. By the Krull-Schmidt property of  $p\text{End}(\mathfrak{T})$  (see Lemma 2.37) and the fact that any direct sum of gradable, additive functors in an additive category is gradable, it suffices to show that indecomposable projective functors are gradable. By Lemma 2.38 these are given by tensoring with a  $T_q(i)$  for some  $i \in \mathbb{Z}_{\geq 0}$ . By Proposition 3.19 all objects of  $\mathfrak{T}$  are gradable and, by Lemma 2.18 part (b), the category  $\mathfrak{T}$  is preserved by finite tensor products. Thus, the indecomposable projective functors are gradable. For  $p\text{End}(\mathfrak{T}_\lambda)$  this follows from Corollary 3.24.  $\blacksquare$

Proposition 3.26 motivates the definition of  $p\text{End}(\mathfrak{T}_\lambda^{\text{gr}})$  which can be defined in the spirit of (13) (thus, using *graded* hom-spaces of natural transformations). This is the same as saying that the category  $p\text{End}(\mathfrak{T}_\lambda^{\text{gr}})$  is graded in the above sense.

In order to state the proposition, we write  $\mathbb{T}_\infty \mathcal{F}(T_q(\infty))$  short for  $\bigoplus_i \mathbb{T}_\infty \mathcal{F}(T_q(\mathbf{i}))$ . This is an  $Q_\infty$ -bimodule via pre-composition (right) and post-composition (left) with  $\mathcal{F}(\cdot)$  or  $\mathcal{F}'(\cdot)$ .

Moreover, recall that the superscript fs indicates that we are only considering finitely supported homomorphisms. We have the following (similar of course for  $p\text{End}(\mathfrak{T}_\lambda^{\text{gr}}(\leq \mathbf{m}))$ ).

**Proposition 3.27.** Let  $\mathcal{F}, \mathcal{F}'$  be two functors in  $p\text{End}(\mathfrak{T}_\lambda^{\text{gr}})$ . Then there exists an isomorphism of graded  $\mathbb{Q}(q)$ -vector spaces

$$\text{Hom}_{p\text{End}(\mathfrak{T}_\lambda^{\text{gr}})}^{\text{fs}}(\mathcal{F}, \mathcal{F}') \cong \text{Hom}_{Q_\infty\text{-}p\text{Mod}_{\text{gr}}\text{-}Q_\infty}^{\text{fs}}(\mathbb{T}_\infty \mathcal{F}(T_q(\infty)), \mathbb{T}_\infty \mathcal{F}'(T_q(\infty))).$$

This is an isomorphism of graded rings if  $\mathcal{F} = \mathcal{F}'$ .  $\square$

*Proof.* It suffices to verify the statement for the translation onto  $\mathcal{T}_\lambda^\mu$ , out of  $\mathcal{T}_\mu^\lambda$  and the through the wall functors  $\Theta_{s \text{ or } t}^\lambda$ . By Theorem 3.12 part (d), (f) and (g) it suffices to show the statement for the corresponding  $\mathcal{U}$ 's.

Without loss of generality, we only discuss the “even” case, that is,  $\mathcal{U}_{\text{even}}^t$ ,  $\mathcal{U}_t^{\text{even}}$  and  $\mathcal{U}_{\text{even}}^\infty$  which correspond to  $\mathcal{T}_\lambda^{-1}$ ,  $\mathcal{T}_{-1}^\lambda$  and  $\Theta_s^\lambda$  respectively. Thus, by additivity, it suffices to show the statement for  $\mathcal{U}_i^t$ ,  $\mathcal{U}_t^i$  and  $\mathcal{U}_i$  for  $i > 0$  even. Fix  $i$  and assume that  $i \ll m$ . Recall that Khovanov and Seidel have shown in [36, Proposition 2.9] that  $p\text{Mod}\text{-}Q_m$  and  $\mathcal{O}_0^{\mathfrak{p}}$  for  $\mathfrak{sl}_{m+1}$  and parabolic  $\mathfrak{p}$  of type  $S_1 \times S_{m-1}$  are equivalent. Moreover, as they explain below [36, Proposition 2.9],  $\mathcal{U}_i^t$ ,  $\mathcal{U}_t^i$  and  $\mathcal{U}_i$  correspond to the translation onto, out off and through the  $i$ -th wall functors.

Note now that the same holds for the graded version of  $\mathcal{O}_0^{\mathfrak{p}}$  introduced in [57] as Stroppel explains in [58, Section 1]. Thus, we can use [58, Theorem 1.12] to finish the proof in the “cut-off case”. Taking the inductive limit now shows the statement.  $\blacksquare$

**Corollary 3.28.** There is an isomorphism of graded rings

$$\text{End}_{\text{gr}}^{\text{fs}}(\text{id}) \cong Z(Q_\infty),$$

where  $\text{id}$  is the identity functor on  $\mathfrak{T}_\lambda^{\text{gr}}$ ,  $Z(Q_\infty)$  is the center of  $Q_\infty$  and the endomorphism ring is to be taken in  $p\text{End}(\mathfrak{T}_\lambda^{\text{gr}})$ .  $\square$

*Proof.* From Proposition 3.10 combined with Proposition 3.27. Note that we get the center  $Z(Q_\infty)$  and not  $Q_\infty$  itself because the endomorphism ring from Proposition 3.10 is as  $U_q$ -intertwiners while the one induced from Proposition 3.27 is as  $Q_\infty\text{-}p\text{Mod}_{\text{gr}}\text{-}Q_\infty$ -bimodule intertwiners.  $\blacksquare$

**Remark 3.29.** It is known that the split Grothendieck group  $K_0^\oplus(\cdot) = K_0^\oplus(\cdot) \otimes_{\mathbb{Z}[v, v^{-1}]} \mathbb{Q}(q)$  (viewed as a module over  $\mathbb{Z}[v, v^{-1}]$  where the formal parameter  $v$  comes for the grading) of  $p\text{Mod}_{\text{gr}-Q_m}$  categorifies the Burau representation  $\mathcal{B}_{m+1}$  of the  $m+1$ -strand braid group  $B_{m+1}$  (the action of  $B_{m+1}$  is induced via functors constructed from  $\mathcal{U}_i$ ), see [36, Proposition 2.8 and Subsection 2.d]. Using Theorem 3.11, we see that the same is true for  $\mathfrak{T}_\lambda^{\text{gr}}(\leq \mathbf{m})$ , that is  $K_0^\oplus(\mathfrak{T}_\lambda^{\text{gr}}(\leq \mathbf{m})) \cong \mathcal{B}_{m+1}$  as  $B_{m+1}$ -modules. Note now that the limit therefore categorifies the corresponding  $\infty$  version of the Burau representation of the braid group  $B_\infty$  with  $\infty$ -many strands.  $\blacktriangle$

**Remark 3.30.** Fix  $\mathfrak{sl}_{m+1}$  and denote by  $\mathfrak{p}_i$  the parabolic for  $S_i \times S_{m-i}$ . Moreover, we denote by  $\mathcal{O}_{\max}^{\mathfrak{p}} = \bigoplus_{i=0}^m \mathcal{O}_0^{\mathfrak{p}_i}$  the direct sum. We note that, as Bernstein-Frenkel-Khovanov conjectured in [8, Conjectures 1-4] and Stroppel proved in [56], parabolic category  $\mathcal{O}_{\max}^{\mathfrak{p}}$  for  $\mathfrak{sl}_{m+1}$  (compare to Remark 3.16) can be used to categorify the  $m+1$ -strand Temperley-Lieb algebra  $TL_{m+1}^v$ . The split Grothendieck group  $K_0^\oplus$  of the category of projective endofunctors on  $\mathcal{O}_{\max}^{\mathfrak{p}}$  gives<sup>11</sup>  $TL_{m+1}^v$ . The Grothendieck group behaves additive, i.e.

$$TL_{m+1}^v \cong K_0^\oplus(p\text{End}(\mathcal{O}_{\max}^{\mathfrak{p}})) \cong \bigoplus_{i=0}^m K_0^\oplus(p\text{End}(\mathcal{O}_i^{\mathfrak{p}})).$$

Thus,  $p\text{End}(\mathcal{O}_1^{\mathfrak{p}})$  gives a summand  $\overline{TL}_{m+1}^v$  of  $TL_{m+1}^v$  that corresponds to the “next to highest weight” summand of  $V^{\otimes m}$  (with notation as in Remark 3.17), see [16, Section 6].

Thus, as explained in Remark 3.16, by Proposition 3.27, the same is true for  $p\text{End}(\mathfrak{T}_\lambda^{\text{gr}}(\leq \mathbf{m}))$ . Moreover, it is easy to see that the embedding of categories

$$p\text{End}(\mathfrak{T}_\lambda^{\text{gr}}(\leq \mathbf{m})) \hookrightarrow p\text{End}(\mathfrak{T}_\lambda^{\text{gr}}(\leq \mathbf{m} + 1))$$

gives rise to an embedding

$$\overline{TL}_{m+1}^v \cong K_0^\oplus(p\text{End}(\mathfrak{T}_\lambda^{\text{gr}}(\leq \mathbf{m}))) \hookrightarrow K_0^\oplus(p\text{End}(\mathfrak{T}_\lambda^{\text{gr}}(\leq \mathbf{m} + 1))) \cong \overline{TL}_{m+2}^v.$$

Thus, by Proposition 3.10,  $p\text{End}(\mathfrak{T}_\lambda^{\text{gr}})$  governs all of them at once.  $\blacktriangle$

#### 4. DIAGRAMS FOR THE GRADED TILTING CATEGORY $\mathfrak{T}^{\text{gr}}$

In this section we give the diagrammatic presentation of the (graded) tilting category  $\mathfrak{T}_\lambda^{\text{gr}}$  and the category of its projective endofunctors  $p\text{End}(\mathfrak{T}_\lambda^{\text{gr}})$ .

**4.1. The basics: diagrammatic categories, additive closures and Karoubi envelopes.** We consider *diagrammatic* categories in the following. We encourage the reader to take a look in the rather extensive literature (in the authors opinion, a good start is [37, Section 2]). Although these categories have a natural 2-categorical structure, we phrase everything in terms of 1-categories.

Furthermore, we note that we *only* use  $\mathbb{Q}(q)$ -linear categories. Recall that a category  $\mathcal{C}$  is called  $\mathbb{Q}(q)$ -linear if each hom-space  $\text{Hom}_{\mathcal{C}}(O, O')$  for  $O, O' \in \text{Ob}(\mathcal{C})$  has the structure of a  $\mathbb{Q}(q)$ -vector space and the composition of morphisms is  $\mathbb{Q}(q)$ -bilinear (this includes the existence of a zero morphism 0). We use  $\mathbb{Q}(q)$ -linear functors for such categories: functors which induce  $\mathbb{Q}(q)$ -linear maps on each hom-space. We, as in Subsection 3.5, *only* consider  $(\mathbb{Z}$ -)graded categories.

**Definition 4.1. (Additive closure of  $\mathcal{C}$ )** Given a  $\mathbb{Q}(q)$ -linear category  $\mathcal{C}$ , we define its *additive closure*, denoted by  $\text{Mat}(\mathcal{C})$ , to be the  $\mathbb{Q}(q)$ -linear category consisting of the following.

<sup>11</sup>The parameter  $q$  in the notation of Bernstein-Frenkel-Khovanov comes from the grading.

- The objects are finite (possibly empty), formal direct sums  $\bigoplus_{i=1}^N O_i$  with  $O_i \in \text{Ob}(\mathcal{C})$  (note that the empty object is the zero object).
- Given two objects  $O = \bigoplus_{k=1}^N O_k$ ,  $O' = \bigoplus_{k=1}^{N'} O'_k$ , then a morphism  $F \in \text{Hom}_{\text{Mat}(\mathcal{C})}(O, O')$  is a  $N \times N'$  matrix  $F = (f_{i'i})$  consisting of morphisms  $f_{i'i} \in \text{Hom}_{\mathcal{C}}(O_i, O'_{i'})$ .
- One can add the matrices component-wise and scalar multiplication with elements from  $\mathbb{Q}(q)$  is also component-wise.
- Composition of morphisms is multiplication of matrices. ▲

It is easy to check that this definition gives a category.

**Definition 4.2. (Karoubi envelope of  $\mathcal{C}$ )** Let  $\mathcal{C}$  be a category and  $A \in \text{Ob}(\mathcal{C})$  be an object of  $\mathcal{C}$ . Let  $e, e': O \rightarrow O$  denote idempotents in  $\text{End}_{\mathcal{C}}(O)$ . The *Karoubi envelope* of  $\mathcal{C}$ , denoted by  $\mathbf{Kar}(\mathcal{C})$ , is the following category.

- Objects are ordered pairs  $(O, e)$  consisting of an object  $O$  and an idempotent  $e \in \text{End}_{\mathcal{C}}(O)$ .
- Morphisms  $f: (O, e) \rightarrow (O', e')$  in  $\mathbf{Kar}(\mathcal{C})$  are all morphisms  $f: O \rightarrow O'$  of  $\mathcal{C}$  such that the equations  $f = f \circ e = e' \circ f$  hold.
- Compositions are induced by compositions in  $\mathcal{C}$ . ▲

Again, it is immediate that this is indeed a category.

The identity on  $(O, e)$  is  $e$  itself. Moreover, there is a faithful functor  $\text{im}: \mathcal{C} \rightarrow \mathbf{Kar}(\mathcal{C})$ , called *the image*, that sends  $A$  to  $(O, \text{id})$  and  $f: O \rightarrow O'$  to  $f: (O, \text{id}) \rightarrow (O', \text{id})$ . Categories  $\mathcal{C}$  such that  $\mathcal{C} \cong \mathbf{Kar}(\mathcal{C})$  are called *idempotent complete*.

We point out that  $\text{Mat}(\mathcal{C})$  is “combinatorial the same” as  $\mathcal{C}$  – in contrast to  $\mathbf{Kar}(\mathcal{C})$  which is usually very hard to describe combinatorially/diagrammatically.

**4.2. The dihedral cathedral  $\mathfrak{D}(\infty)$ .** For the reader familiar with [18]: be careful that Elias’ “root of unity case” *does not* correspond to our root of unity case from Section 2. Moreover, we slightly rescale his “barbell forcing relation”, see **BF2** (20).

Following [18], we encode the two different generators of  $W_l = \langle s, t \rangle$  using two colors. Our convention, that is different from the one used by Elias, is that  $s$  is displayed in *red* and  $t$  in *green*. The “third color” is for  $1 \in W_l$  which is displayed as *white colored or empty*.

**Definition 4.3. (Soergel graph)** A *pre-Soergel graph*  $\tilde{G}$  is a colored, planar graph embedded in  $[0, 1] \times [0, 1]$  whose bottom (or source) boundary is in  $[0, 1] \times \{0\}$  and whose top (or target) boundary is in  $[0, 1] \times \{1\}$ . The only vertices are univalent (called *dots*) or trivalent. The edges of a Soergel graph are colored by red (or  $r$ ) and green (or  $g$ ) such that at each trivalent vertex all adjacent edges have the same color. We display dots and trivalent vertices locally as

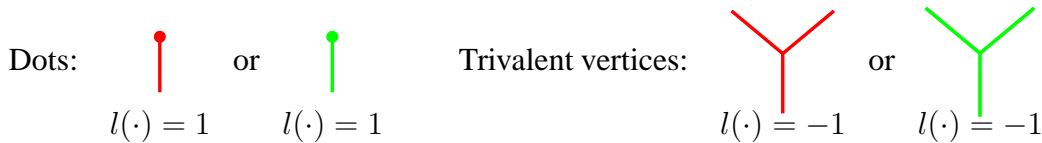

where we tend (as above) not to display the  $r$  and  $g$ . Moreover, the illustration above is locally and Soergel graphs also include for example horizontal reflections of the ones above. In addition, given a pre-Soergel graph  $\tilde{G}$ , we define its *degree*  $l(\tilde{G})$  to be the sum of the local degrees as above.

A *Soergel graph*  $G$  is an equivalence class of pre-Soergel graphs modulo boundary preserving isotopies of colored, planar graphs (which are all locally of the forms as in (21)). Note that the degree is still well-defined for a Soergel graph and we denote it by  $l(G)$ . The empty diagram  $\mathbf{0}$  is also a Soergel graph and of degree  $l(\mathbf{0}) = 0$ .



Each Soergel graph gives rise to a bottom sequence  $b(G) = b_i \dots b_2 b_1$  and a top sequence  $t(G) = t_i \dots t_2 t_1$  of colors  $b_k, t_k \in \{r, g\}$  by reading the colors at the bottom or top boundary from *right to left* respectively. We also allow the empty sequence, if the boundary is empty (at bottom or top). We call a Soergel graph (or a local piece of it) *floating*, if both boundaries are empty. We call floating Soergel graphs consisting of only one edge *barbells*. ▲

Our reading conventions are thus from *right to left* (we think of the pictures as applying functors to a module) and *bottom to top*. Moreover, we think of Soergel graphs as embedded into a rectangle (although we never illustrate the rectangle), and thus, it make sense to speak about *faces* of Soergel graphs. Each Soergel graph has a unique rightmost face  $F_r$  and a unique leftmost face  $F_l$ .

**Example 4.4.** An example of two representatives of a Soergel graph  $G$  are

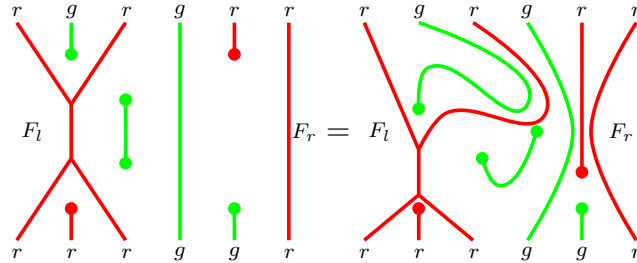

Here  $l(G) = 4$ ,  $b(G) = rrrggr$  and  $t(G) = rgrgrr$ . The graph above has one (green) barbell. We have marked the unique right- and leftmost faces with  $F_r$  and  $F_l$  respectively. ▲

Note that, since  $G$  completely determines  $b(G)$  and  $t(G)$ , we do not display these anymore.

**Definition 4.5. (Elias' dihedral cathedral  $\mathfrak{D}(\infty)$ )** We consider the  $\mathbb{Q}(q)$ -linear, graded, monoidal category called the *free dihedral cathedral*, denote by  $\mathfrak{D}(\infty)_f$ , consisting of the following.

- Objects  $\text{Ob}(\mathfrak{D}(\infty)_f)$  are finite sequences  $x = x_i \dots x_2 x_1$  with  $x_i \in \{r, g\}$ . Moreover, the empty sequence  $\emptyset$  is also an object.
- The space of morphisms  $\text{Hom}_{\mathfrak{D}(\infty)_f}(x, x')$  for  $x, x' \in \text{Ob}(\mathfrak{D}(\infty)_f)$  is the  $\mathbb{Q}(q)$ -linear span of all Soergel graphs  $G$  with  $b(G) = x$  and  $t(G) = x'$ .
- Composition (vertical) of morphisms  $G' \circ_v G$  is defined by glueing  $G'$  on top of  $G$ .
- The monoidal product (horizontal)  $\circ_h$  is, for  $x = x_i \dots x_2 x_1$  and  $x' = x'_i \dots x'_2 x'_1$ , given by concatenation  $x' \circ_h x = x' x$ , and for  $G' \circ_h G$  via placing  $G'$  to the left of  $G$ .
- The spaces  $\text{Hom}_{\mathfrak{D}(\infty)_f}(x, x')$  are graded  $\mathbb{Q}(q)$ -vector spaces where the degree of a Soergel graph  $G$  is given by  $l(G)$ .

The category  $\mathfrak{D}(\infty)$  is the quotient category of  $\mathfrak{D}(\infty)_f$  obtained by taking the quotient by the following local relations and their *color-inverted* (red  $\rightleftharpoons$  green) counterparts.

The two Frobenius relations:

$$(18) \quad \text{Frob1} : \begin{array}{c} \diagup \quad \diagdown \\ | \\ \diagdown \quad \diagup \end{array} = \begin{array}{c} \diagdown \quad \diagup \\ | \\ \diagup \quad \diagdown \end{array}, \quad \text{Frob2} : \begin{array}{c} \diagup \quad \diagdown \\ | \\ \diagdown \quad \diagup \end{array} = | = \begin{array}{c} \diagdown \quad \diagup \\ | \\ \diagup \quad \diagdown \end{array}$$

The *needle relation*:

$$(19) \quad \text{Needle} : \begin{array}{c} \circ \\ | \end{array} = 0$$

The *barbell forcing relations*:

$$(20) \quad \mathbf{BF1} : \begin{array}{c} \bullet \\ | \\ \bullet \end{array} \Big| = 2 \cdot \begin{array}{c} \bullet \\ | \\ \bullet \end{array} - \begin{array}{c} \bullet \\ | \\ \bullet \end{array}, \quad \mathbf{BF2} : \begin{array}{c} \bullet \\ | \\ \bullet \end{array} \Big| = \begin{array}{c} \bullet \\ | \\ \bullet \end{array} + 2 \cdot \begin{array}{c} \bullet \\ | \\ \bullet \end{array} - 2 \cdot \begin{array}{c} \bullet \\ | \\ \bullet \end{array}$$

Note that the isotopy invariance can be locally displayed via the *isotopy relations*:

$$(21) \quad \mathbf{Iso1} : \begin{array}{c} \cup \\ \bullet \end{array} = \begin{array}{c} \bullet \\ | \\ \bullet \end{array} = \begin{array}{c} \bullet \\ \cup \end{array}, \quad \mathbf{Iso2} : \begin{array}{c} \cup \\ \cup \end{array} = \begin{array}{c} \cup \\ \cup \end{array} = \begin{array}{c} \cup \\ \cup \end{array}$$

together with a horizontal reflection of the two relations.

We also note that all relations are homogeneous with respect to  $l(G)$  and thus,  $\mathfrak{D}(\infty)$  inherits the grading from  $\mathfrak{D}(\infty)_f$ . The monoidal product  $\circ_h$  also carries over to  $\mathfrak{D}(\infty)$  without difficulties.

Moreover, we use the following convention: we call elements of  $\text{Hom}_{\mathfrak{D}(\infty)_f}(x, x')$  *Soergel graphs* and, on the other hand, elements of  $\text{Hom}_{\mathfrak{D}(\infty)}(x, x')$  *Soergel diagrams* (for all possible  $x, x' \in \text{Ob}(\mathfrak{D}(\infty)_f) = \text{Ob}(\mathfrak{D}(\infty))$ ). We call a face of a Soergel diagram *empty* if it has no internal floating Soergel diagrams (as for example barbells).  $\blacktriangle$

**Example 4.6.** An example of two representatives of Soergel diagrams are

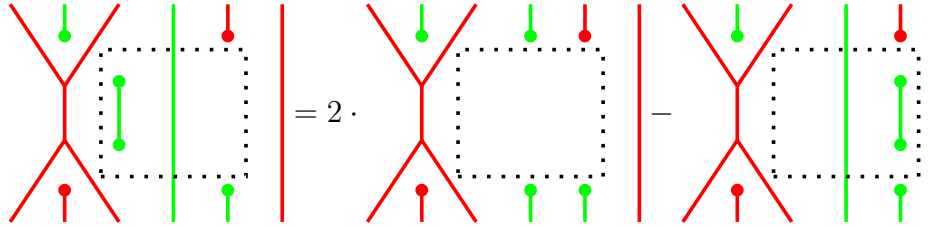

Here we used the left (green) barbell forcing relation (20) on the marked piece.  $\blacktriangle$

**Lemma 4.7.** A Soergel diagram  $G$  with an internal cycle which bounds an empty face is zero.  $\square$

*Proof.* Use repeatedly the first Frobenius relations (18) as illustrated below (note that each step reduces the number of adjacent edges of the face and we have indicated where to use the first Frobenius relation **Frob1** (18) in the last step)

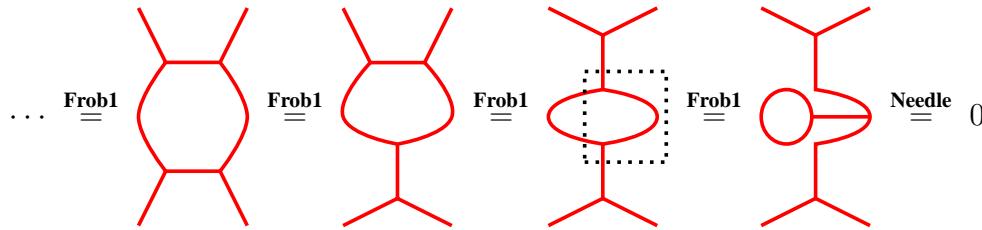

until we can use the needle relation (19) to see that we get zero.  $\blacksquare$

A *tree* is a connected Soergel graph  $G$  with no cycles. We call a Soergel diagram *reduced* if all of its connected components are trees or barbells and all barbells are in the rightmost face.

The following is [18, Proposition 5.19] converted to our conventions.

**Proposition 4.8.** Each Soergel diagram can be written as a  $\mathbb{Q}(q)$ -linear sum of reduced Soergel diagrams. Thus, reduced Soergel diagrams form spanning sets of the hom-spaces of  $\mathfrak{D}(\infty)$ .  $\square$

*Proof.* Note that it follows from a repeated application of the Frobenius relations (18) that all floating trees are barbells and, by combining Lemma 4.7 with **BF1** and **BF2** (20), all other floating Soergel diagrams are  $\mathbb{Q}(q)$ -linear combinations of barbells.

Thus, we can restrict to Soergel diagrams whose only floating components are barbells.

Now, given a Soergel diagram  $G$ , we can first use **BF1** and **BF2** (20) to express  $G$  as a direct sum of Soergel diagrams  $G_i$  (with  $i = 1, \dots, k$ ) with only barbells in the rightmost face. By Lemma 4.7 all Soergel diagrams  $G_i$  with an internal cycle are zero now. ■

We point out the following corollary. This can be compared to [18, Corollary 5.20] and the corresponding statement, in our case for  $\mathfrak{T}^{\text{gr}}$ , will later be completely different, see Lemma 4.18. For this purpose, denote by  $\mathbb{Q}(q)[b_r, b_g]$  the graded  $\mathbb{Q}(q)$ -algebras of polynomials in  $b_r, b_g$ , with the generators  $b_r, b_g$  being of degree 2.

**Corollary 4.9.** We have  $\mathbb{Q}(q)[b_r, b_g] \cong \mathbf{End}_{\mathfrak{D}(\infty)}(\emptyset)$  as graded  $\mathbb{Q}(q)$ -algebras. □

*Proof.* By Proposition 4.8 the map that sends  $b_r \mapsto$ “red barbell” and  $b_g \mapsto$ “green barbell” is an isomorphism of graded  $\mathbb{Q}(q)$ -algebras. To see this note that a bunch of barbells do not satisfy any extra relations (the barbell forcing relations (20) do not give anything new). ■

**Lemma 4.10.** Soergel diagrams satisfy

$$\begin{array}{c} | \\ | \end{array} = \frac{1}{2} \cdot \begin{array}{c} \bullet \\ \diagup \diagdown \\ \bullet \end{array} + \frac{1}{2} \cdot \begin{array}{c} \diagup \diagdown \\ \bullet \end{array} \quad \text{and} \quad \begin{array}{c} | \\ | \end{array} = \frac{1}{2} \cdot \begin{array}{c} \bullet \\ \diagdown \diagup \\ \bullet \end{array} + \frac{1}{2} \cdot \begin{array}{c} \diagdown \diagup \\ \bullet \end{array} \quad \square$$

*Proof.* Use **Frob1** (18) on the right side followed by **BF1** (20) for the middle edge. ■

This implies the useful fact that we can focus on alternating sequences (the case where the sequence is a reduced word in  $\mathfrak{D}(\infty)$ ) of red and green if we go to  $\mathbf{Mat}(\mathfrak{D}(\infty))$  (where we use  $\circ$  for the matrix multiplication).

**Lemma 4.11.** We have

$$rr \cong r\langle -1 \rangle \oplus r\langle +1 \rangle \quad \text{and} \quad gg \cong g\langle -1 \rangle \oplus g\langle +1 \rangle.$$

which are isomorphisms in  $\mathbf{Mat}(\mathfrak{D}(\infty))$ . □

*Proof.* The isomorphism for the red case is induced by

$$rr \longrightarrow \begin{pmatrix} 1 \cdot \begin{array}{c} \diagup \diagdown \\ \bullet \end{array} \\ \frac{1}{2} \cdot \begin{array}{c} \bullet \\ \diagup \diagdown \\ \bullet \end{array} \end{pmatrix} \longrightarrow r\langle -1 \rangle \oplus r\langle +1 \rangle \cdot \left( \frac{1}{2} \cdot \begin{array}{c} \bullet \\ \diagdown \diagup \\ \bullet \end{array} \quad 1 \cdot \begin{array}{c} \diagdown \diagup \\ \bullet \end{array} \right) \Rightarrow rr,$$

where we check (with Lemma 4.10 for “right $\circ$ left” and Lemma 4.7 together with **BF1** (20) for “left $\circ$ right”) that the two matrices above are inverses. The green case works analogous. ■

**Definition 4.12. (Jones-Wenzl projectors)** Denote by  $x_{k-tst}$  a sequence  $x_k \dots x_2 x_1$  of length  $k$  that alternates in the colors red and green and starts with  $x_1 = g$  (thus, ends in  $r$  iff  $k$  is even).

We define for each  $i \geq 0$  the  $i$ -th green Jones Wenzl projector  $JW_i^g$  recursively as the element of  $\mathbf{End}_{\mathfrak{D}(\infty)}(x_{i-tst})$  obtained via the convention that  $JW_0^g$  is  $\mathbf{0}: \emptyset \rightarrow \emptyset$ ,  $JW_1^g$  is  $\text{id}: g \rightarrow g$ ,  $JW_2^g$  is

id:  $rg \rightarrow rg$  and recursion rule for  $i > 2$  given by

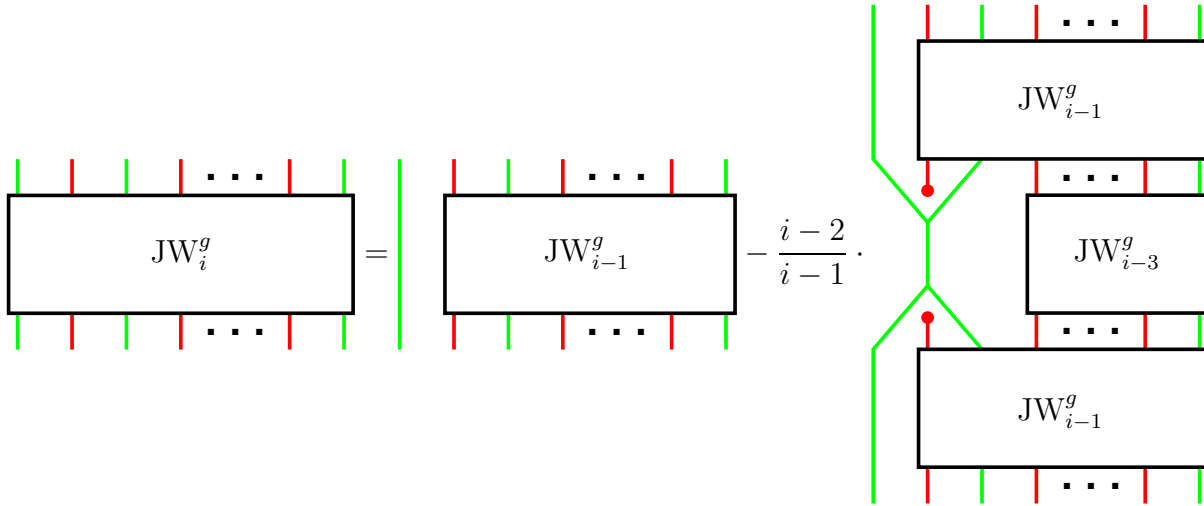

Here we have only illustrated the case for odd  $i$ . Similar for even  $i$  and red projectors  $JW_i^r$ . ▲

**Example 4.13.** The first four (green) Jones-Wenzl projectors are

$$JW_0^g = \mathbf{0}, \quad JW_1^g = \begin{array}{|c|} \hline \text{green line} \\ \hline \end{array}, \quad JW_2^g = \begin{array}{|c|} \hline \text{green line} \\ \hline \end{array}, \quad JW_3^g = \begin{array}{|c|} \hline \text{green line} \\ \hline \end{array} - \frac{1}{2} \begin{array}{|c|} \hline \text{green pitchfork} \\ \hline \end{array}$$

as follows by an easy calculation. ▲

For each  $i' > 2$  we call a diagram of the form

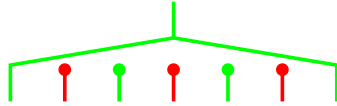

a *green alternating  $i'$ -pitchfork* (here  $i' = 7$ ). We denote it by  $P_{i'}^g$  and similarly for  $P_{i'}^r$ , which is the  *$i'$ -th red alternating pitchfork*. We note that  $b(P_{i'}^g)$  as well as  $b(P_{i'}^r)$  consist of  $i'$  elements. Moreover, we write  $D_i(P_{i'}^g)$  for a bigger diagram with  $i \geq i' > 2$  which somewhere at the bottom has a green alternating pitchfork, i.e.

$$(22) \quad D_i(P_{i'}^g) = D \circ (\text{id}_x P_{i'}^g \text{id}_{x'})$$

for some sequences  $x, x'$  and some diagram  $D$ . Similarly for red again.

**Lemma 4.14.** Let  $i \geq i' > 2$ . Then  $D_i(P_{i'}^g) \circ JW_i^g = 0$ . Similarly for red. □

*Proof.* This follows recursively. To see the first step  $i = i' = 3$ , we compose  $P_3^g$  with the second term of  $JW_3^g$  from Example 4.13 and obtain by using **BF2** (20) and Lemma 4.7 for the first step and **Frob2** (18) for the second:

$$-\frac{1}{2} \cdot \begin{array}{|c|} \hline \text{green pitchfork with red dot} \\ \hline \end{array} = -\frac{1}{2} \cdot 2 \cdot \begin{array}{|c|} \hline \text{green pitchfork} \\ \hline \end{array} = - \begin{array}{|c|} \hline \text{green pitchfork} \\ \hline \end{array}$$

giving minus the composition of  $P_3^g$  with the first term of  $JW_3^g$ . Thus,  $D_3(P_3^g) \circ JW_3^g = 0$ .

Now we use induction on  $i$  and fix  $i' = 3$ . If  $i > 3$  and  $D_i(P_3^g)$  has  $x \neq \emptyset$  (see (22)), then the recursion rule from Definition 4.12 (the 3-pitchfork is on top of the smaller box that corresponds to the  $i - 1$ -th Jones-Wenzl projector) shows by induction that we get zero. If, on the other hand,  $x = \emptyset$ , then we can use a similar argument as above. Hence, we always have  $D_i(P_3^g) \circ \text{JW}_i^g = 0$ .

But the case  $i' = 3$  suffices as the following illustrates.

Here we used **Frob2** (18) “backwards” on a bigger alternating pitchfork followed by **BF1** (20). We see now two smaller pitchforks and thus, the case  $i' = 3$  suffices to verify the lemma. ■

Lemma 4.14 holds, mutatis mutandis, by attaching horizontally reflected pitchforks from the bottom as well. Moreover, it is easy to deduce that the Jones-Wenzl projectors are (degree zero) idempotents of  $x_{i-tst}$  and  $x_{i-sts}$ , respectively. We associate these to the corresponding alternating sequences. Furthermore, by Lemma 4.11, we can, by going to  $\text{Mat}(\mathfrak{D}(\infty))$ , associate to each  $x \in \text{Ob}(\mathfrak{D}(\infty))$  a (shifted) direct sum of Jones-Wenzl projectors. We denote this sum that consists of these projectors for  $x$  by  $\text{JW}x$ . This motivates the following category.

**Definition 4.15.** Denote by  $\text{Mat}(\widehat{\mathfrak{D}}(\infty))$  the full subcategory of  $\text{Kar}(\text{Mat}(\mathfrak{D}(\infty)))$  generated by  $\text{im}(\text{JW}x)$  for all  $x \in \text{Ob}(\mathfrak{D}(\infty))$ . ▲

Diagrammatically  $\text{Mat}(\widehat{\mathfrak{D}}(\infty))$  is given similarly to  $\text{Mat}(\mathfrak{D}(\infty))$ , but has some extra relations. For example, Lemma 4.14 says that, whenever we see a pitchfork at the bottom (or its reflection at the top) boundary, then the corresponding Soergel diagram is zero.

**4.3. The quotient  $\mathfrak{QD}(\infty)$ .** We are now able to define the category whose combinatorics and diagrammatic govern the tilting category  $\mathfrak{T}^{\text{gr}}$ . We call it for short *the quotient*.

**Definition 4.16. (The quotient)** We denote by  $\mathfrak{QD}(\infty)_f$  the  $\mathbb{Q}(q)$ -linear full subcategory of  $\mathfrak{D}(\infty)$ , called “free quotient”, consisting of the following.

- Objects  $\text{Ob}(\mathfrak{QD}(\infty)_f)$  are finite sequences  $x = x_i \dots x_2 x_1$  with  $x_k \in \{r, g\}$ . Moreover, the empty sequence  $\emptyset$  is also an object.
- The hom-space  $\text{Hom}_{\mathfrak{QD}(\infty)_f}(x, x')$  for  $x, x' \in \text{Ob}(\mathfrak{QD}(\infty)_f)$  is the  $\mathbb{Q}(q)$ -linear span of all Soergel graphs  $G$  with  $b(G) = x$  and  $t(G) = x'$  whose rightmost face is marked with the *dead-end symbol*.
- Composition  $G' \circ_v G$  is defined by glueing  $G'$  on top of  $G$ . The dead-end symbol is just a marker and behaves as an idempotent under composition and can not be moved from the rightmost face.
- The morphisms in  $\text{Hom}_{\mathfrak{QD}(\infty)_f}(x, x')$  satisfy the relations of the corresponding morphisms (*without* the dead-end marker) is  $\text{Hom}_{\mathfrak{D}(\infty)}(x, x')$  given in Definition 4.5.
- The spaces  $\text{Hom}_{\mathfrak{QD}(\infty)_f}(x, x')$  are graded  $\mathbb{Q}(q)$ -vector spaces with degree given by  $l(G)$ .

The *quotient*  $\mathfrak{QD}(\infty)$  is the quotient of  $\mathfrak{QD}(\infty)_f$  by the following extra relations which we call *the dead-end relations*:

$$(23) \quad \text{DE1 : } \begin{array}{c} | \\ \hline \end{array} = 0, \quad \text{DE2 : } \begin{array}{c} | \\ \hline \end{array} = 0$$

We stress that we do not allow the color inverted counterparts of (23). All relations are homogeneous with respect to  $l(G)$  and thus,  $\mathfrak{SD}(\infty)$  inherits the grading from  $\mathfrak{D}(\infty)$ . We call the morphisms in  $\mathfrak{SD}(\infty)$  *marked Soergel diagrams*.  $\blacktriangle$

**Example 4.17.** An example of a Soergel diagram that is zero as a marked Soergel diagrams is

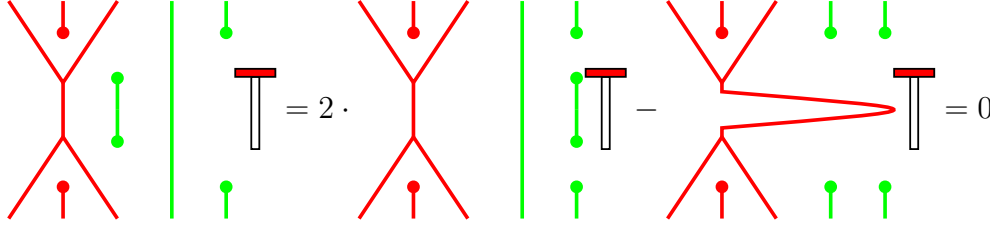

Here the middle diagrams is zero due to **DE2** and the right-hand due to **DE1**.  $\blacktriangle$

Let *reduced*, marked Soergel diagrams be the evident analogues of reduced Soergel diagrams.

**Lemma 4.18.** Each marked Soergel diagram can be written as a  $\mathbb{Q}(q)$ -linear sum of marked, reduced Soergel diagrams. Thus, marked, reduced Soergel diagrams without barbells form spanning sets of the hom-spaces of  $\mathfrak{SD}(\infty)$ . The right action of  $\mathbf{End}_{\mathfrak{SD}(\infty)}(\emptyset)$  by placing barbells in the rightmost face is the trivial action.  $\square$

*Proof.* Use repeatedly **BF1** and **BF2** (20) to shift all existing barbells to the rightmost region. Then use the two dead-end relations **DE1** and **DE2** (23) to see that only terms without barbells are not killed. The remaining diagrams are reduced by Proposition 4.8.  $\blacksquare$

Note that, as a consequence of Lemma 4.18, a marked, reduced Soergel diagram does not have any floating components anymore.

**Definition 4.19.** Denote by  $\mathbf{Mat}(\widehat{\mathfrak{SD}}(\infty))$  the full subcategory of  $\mathbf{Kar}(\mathbf{Mat}(\mathfrak{SD}(\infty)))$  generated by  $\text{im}(\text{JW}x)$  for all  $x \in \text{Ob}(\mathfrak{SD}(\infty))$ .  $\blacktriangle$

Thus, by using Lemma 4.11 and **DE1** (23), we usually can focus on alternating sequences  $x$  that start with  $g$  in the following.

Given a marked, reduced Soergel diagram  $G$ , we call two edges  $E_1, E_2$  *face sharing*, if  $E_1$  and  $E_2$  are adjacent to some common face. Marked, reduced Soergel diagrams  $G$  (with color alternating boundary) with face sharing edges of the same color come in four types, where we, by Lemma 4.14, ignore diagrams with pitchforks. The first two types are

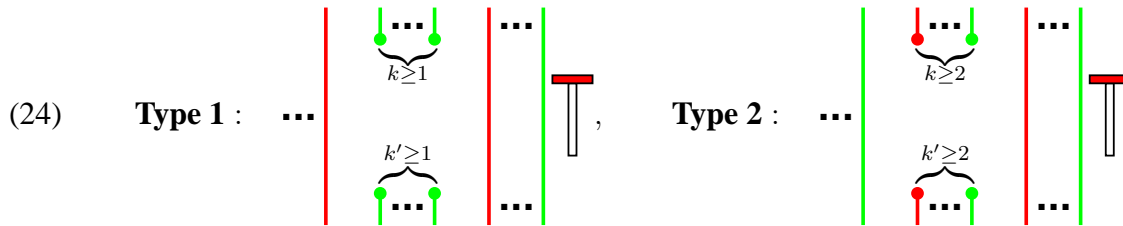

where the dots  $\dots$  mean an arbitrary (possible empty) diagram in between and we do not require the picture to be symmetric. Moreover,  $k, k'$  are odd in **Type 1** and even in **Type 2**. We should note that only the first edge has to be green, but we allow possible color inversion of the rest of the

picture (that is, after the rightmost dots). The other two types are

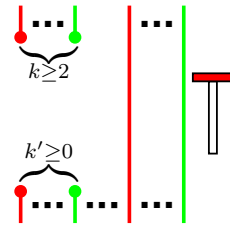
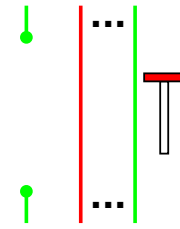
(25) **Type 3 :** , **Type 4 :** 

The difference between the types 1,2 and 3,4 is that 1,2 have face sharing edges for a non-extremal face, while 3,4 have face sharing edges for the leftmost face. We note that **Type 3** should also include the horizontal reflection (fixing the dead-end symbol) of the first diagram in (25).

**Lemma 4.20.** If a marked, reduced Soergel diagram  $G \in \text{Hom}_{\text{Mat}(\widehat{\Omega\mathfrak{D}}(\infty))}(x, x')$  has two face sharing edges of one of the three types 1,2 or 3, then it is zero.  $\square$

*Proof.* A case-by-case check. We assume that there is at least one such face.

**Type 1.** This follows via

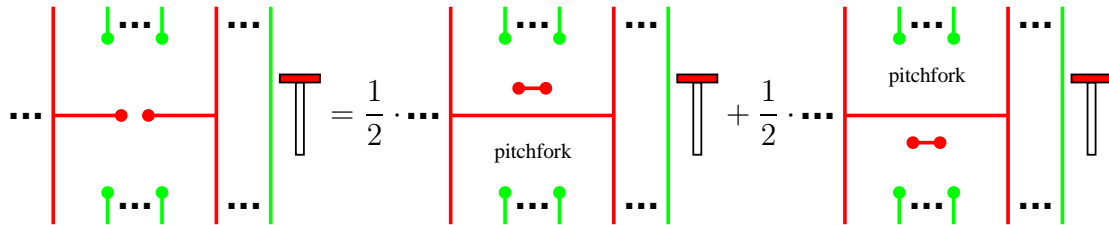

That both diagrams are zero follows from Lemma 4.14 (recalling that we have restricted ourselves to alternating sequences of colors), since the marked faces above are, by (18), pitchforks.

**Type 2.** This follows similarly to **Type 3** below.

**Type 3.** Note that the number of bottom edges at the end does not matter and we thus, by simplicity, assume that there are none of these. In addition, we only illustrate the case with two dotted edges at the top since all the others will be similar. And, without loss of generality, we assume that this is the only face with adjacent edges of the same color.

We proceed by induction on  $j$ , where  $j > 0$  is the minimal number of cuts that a line drawn from the rightmost face to the face in question needs. The case  $j = 1$  can be deduced via

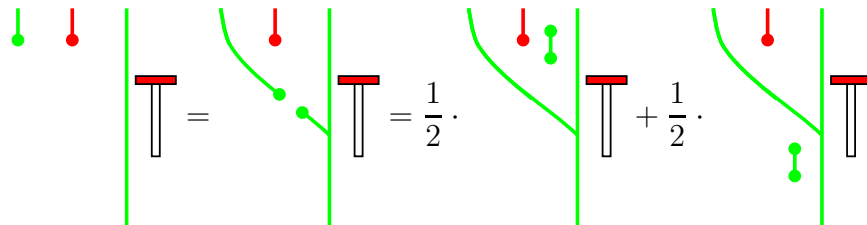

Note that the rightmost diagram is zero by Lemma 4.14. Thus, we continue as

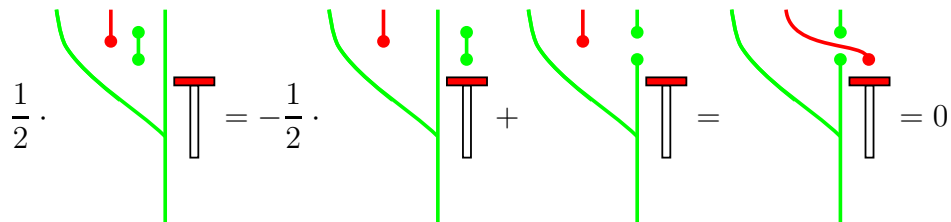

where the last diagram is zero due to **DE1** (23).

This shows that our starting diagram was already zero. The induction  $j > 1$  works now in a similar fashion where we perform the same sequence of moves until we are in a situation as the last step above. Then we can use induction, since we have created a face with edges of the same color, but “closer” to the rightmost face. This finishes the proof.  $\blacksquare$

**Corollary 4.21.** Let  $i, i' \in \mathbb{Z}_{\geq 0}$ . Then we have the following for  $i, i' \neq 0$ .

$$\mathrm{Hom}_{\mathrm{Mat}(\widehat{\mathfrak{D}}(\infty))}(x_{i-tst}, x_{i'-tst}) \cong \begin{cases} \mathbb{Q}(q)\mathbf{i} \oplus \mathbb{Q}(q)\varepsilon_i, & \text{if } |i - i'| = 0, \\ \mathbb{Q}(q)u_i, & \text{if } i' - i = 1, \\ \mathbb{Q}(q)d_i, & \text{if } i - i' = 1, \\ 0, & \text{if } |i - i'| > 1, \end{cases}$$

with diagrams for  $i = 1, 2, \dots$  (and possible color inverted left sides)

$$\mathbf{i} = \begin{array}{c} x_i \quad x_{i-1} \quad x_1 \\ | \quad | \quad | \\ \dots \\ | \quad | \quad | \\ x_i \quad x_{i-1} \quad x_1 \end{array}, \quad \varepsilon_i = \frac{1}{2^i} \cdot \begin{array}{c} x_i \quad x_{i-1} \quad x_1 \\ \bullet \quad | \quad | \\ \dots \\ | \quad | \quad | \\ x_i \quad x_{i-1} \quad x_1 \end{array}, \quad u_{i-1} = \begin{array}{c} x_i \quad x_{i-1} \quad x_1 \\ \bullet \quad | \quad | \\ \dots \\ | \quad | \quad | \\ x_{i-1} \quad x_1 \end{array}, \quad d_i = \frac{1}{2^i} \cdot \begin{array}{c} x_{i-1} \quad x_1 \\ | \quad | \\ \dots \\ | \quad | \\ x_i \quad x_{i-1} \quad x_1 \end{array}$$

of degree  $l(\mathbf{i}) = 0$ ,  $l(u_i) = l(d_i) = 1$  and  $l(\varepsilon_i) = 2$ . In addition,  $\mathrm{Hom}_{\mathrm{Mat}(\widehat{\mathfrak{D}}(\infty))}(\emptyset, \emptyset)$  is one dimensional and spanned by the empty diagram  $\mathbf{0}$  of degree  $l(\mathbf{0}) = 0$ .  $\square$

*Proof.* A case-by-case check using Lemma 4.20. That  $\mathrm{Hom}_{\mathrm{Mat}(\widehat{\mathfrak{D}}(\infty))}(\emptyset, \emptyset) \cong \mathbb{Q}(q)\mathbf{0}$  follows from **DE1** and **DE2** (23) since no floating diagrams can exist.

If  $|i - i'| > 1$ , then each Soergel diagram has a pitchfork or is of **Type 3** (25). Both are zero by Lemmas 4.14 and 4.20. If  $|i - i'| = 1$ , then, by Lemma 4.20 again, only diagrams of the form  $u_i$  or  $d_i$  as above can be non-zero and these are clearly non-zero. If  $|i - i'| = 0$ , then, again by Lemma 4.20, only diagrams of the form  $\mathbf{i}$  or  $\varepsilon_i$  as above can be non-zero (which they clearly are).

All these diagrams are linearly independent for degree reasons.  $\blacksquare$

**Remark 4.22.** Let  $\mathcal{C}$  be a category given by generators and relations. Usually it is very hard to see “by hand” that the calculus provided by  $\mathcal{C}$  does not collapse. A way to show that this is not the case is to represent  $\mathcal{C}$  on a category “under control”, e.g. on module categories.

We formally have to do the same to see that the four maps from above are indeed non-zero. What we use in our case is Lemma 4.26 which identifies the four maps with the evident  $U_q$ -intertwiners (we point out that we do not need Corollary 4.21 to prove Lemma 4.26).  $\blacktriangle$

**Proposition 4.23.** We have

$$u_i \circ u_{i-1} = 0 = d_i \circ d_{i+1}, \quad i = 1, 2, \dots, \quad d_{i+1} \circ u_i = \varepsilon_i = u_{i-1} \circ d_i, \quad i = 1, 2, \dots \\ d_1 \circ u_0 = 0,$$

where we use the notation from Corollary 4.21.  $\square$



*Proof.* The relation  $d_1 \circ u_0$  is **DE2** (23). For  $u_i \circ u_{i-1} = 0$  the corresponding diagrams are

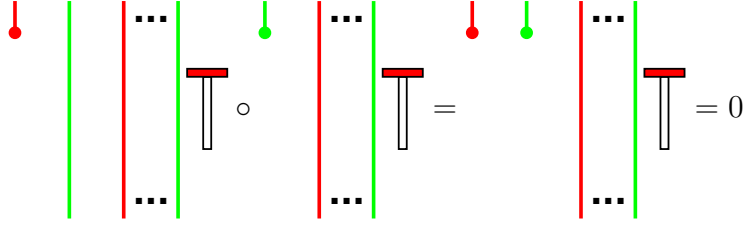

The relation  $d_i \circ d_{i+1} = 0$  follows similar and  $u_{i-1} \circ d_i = \varepsilon_i$  can be verified directly as

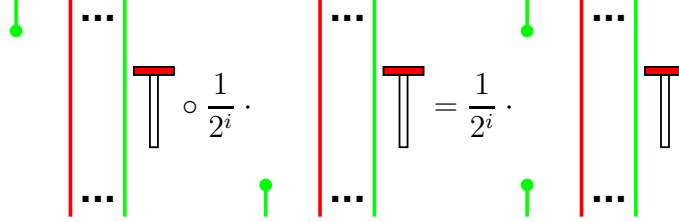

while  $d_{i+1} \circ u_i = \varepsilon_i$  follows via

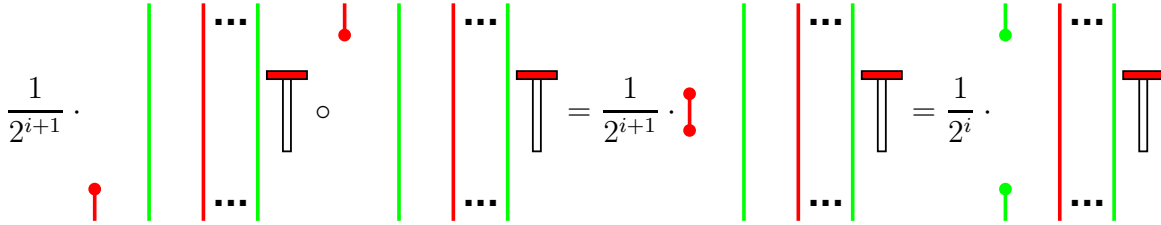

where we use **BF2** (20) together with Lemma 4.20 to see that the only surviving term is the “broken” one from **BF2** (20). This finishes the proof.  $\blacksquare$

4.4.  $\mathfrak{QD}(\infty)$  and the tilting category  $\mathfrak{T}^{\text{gr}}$ . Given a sequence  $x \in \text{Ob}(\mathfrak{QD}(\infty))$  of the form  $x_i \dots x_2 x_1$  with  $x_k \in \{r, g\}$  we denote by  $\tilde{\ell}(x)$  the *number of color changes* (including the first from empty to green), e.g.  $\tilde{\ell}(g) = \tilde{\ell}(gg) = 1$ ,  $\tilde{\ell}(ggrgrgrr) = 6$  and  $\ell(x) = \tilde{\ell}(x)$  iff  $x$  is alternating.

**Definition 4.24. (Diagrammatic presentation)** Define a  $\mathbb{Q}(q)$ -linear functor

$$\mathcal{D}_\infty: \text{Mat}(\widehat{\mathfrak{QD}}(\infty)) \rightarrow \mathfrak{T}_\lambda^{\text{gr}}$$

of graded categories by the following convention.

On objects (we treat degree shifted objects in the evident way):

- Send the empty sequence  $\emptyset$  to  $T_q(\mathbf{0})$ . If  $x \in \text{Ob}(\mathfrak{QD}(\infty))$  is of the form  $x_i \dots x_2 x_1$  with  $x_k \in \{r, g\}$ , then define

$$\mathcal{D}_\infty(x) = p_{T_q(\lambda_{\tilde{\ell}(x)})} \circ \Theta_{x_i} \circ \dots \circ \Theta_{x_2} \circ \Theta_{x_1} T_q(\mathbf{0}),$$

where we use the convention  $r = s$ ,  $g = t$  and  $p_{T_q(\lambda_{\tilde{\ell}(x)})}$  projects to the  $T_q(\lambda_{\tilde{\ell}(x)})$  part.

- Send a general  $x \in \text{Ob}(\text{Mat}(\widehat{\mathfrak{QD}}(\infty)))$  to the direct sum of the images of its components.

All marked Soergel diagrams are compositions of diagrams of the form  $D'GD$  with identity diagrams  $D$  and  $D'$  and a generator  $G$  in between. On morphisms:

- We describe the image of marked Soergel diagrams *inductively from right to left*. That is, we describe what the functor does if one has already an identity diagram  $D: x \rightarrow x$  and  $\mathcal{D}_\infty(D): M_k \rightarrow M_k$  (with  $\mathcal{D}_\infty(x) \cong M_k$ ) and one adds a generator to the *left*.

- By construction of the image on objects and Corollaries 2.35 and 3.25,  $M_k$  will be just one  $T_q(\lambda_k)$  with some multiplicity and grading shifts and some  $k \in \{0, \dots, i\}$  giving two cases, namely  $k = \tilde{l}(x)$  even or odd. That is, we have

$$M_k = T_q(\lambda_k)\langle s_1 \rangle \oplus \dots \oplus T_q(\lambda_k)\langle s_{k'} \rangle.$$

Note that the translation functors  $\Theta_s$  and  $\Theta_t$  act on the summands as in Corollaries 2.35 and 3.25 separately. To simplify notation, we write  $\Theta_t(M_k) = M_{k+1}$  if  $k$  is even and  $\Theta_t(M_k) = M_k\langle -1 \rangle \oplus M_k\langle +1 \rangle = \tilde{M}_k$  if  $k$  is odd and vice versa for  $\Theta_s$ . Moreover, in the case  $k = 0$  we send any red generator to zero.

- The inductive description has four cases. We call these *green-even*, *green-odd*, *red-even* and *red-odd* where we only give the list for the first two since the other two are similar with exchanged conventions for even and odd. Each case has five sub-cases (for the five generators) giving twenty cases in total. We write  $D_0$  (even) and  $D_1$  (odd) for the two different cases. Since the  $M_k$ 's could already consist of multiple, shifted copies of  $T_q(\mathbf{i})$ 's, the entries in the matrices below are shorthand notations for matrices *themselves*.
- Basic pieces: send the empty sequence  $\mathbf{0}$  to  $\text{id}: T_q(\mathbf{0}) \rightarrow T_q(\mathbf{0})$ . Moreover, for a green identity we assign

$$\begin{array}{c} | \\ \text{---} \\ | \end{array} \begin{array}{c} \text{---} \\ \text{---} \\ \text{---} \\ | \end{array} \begin{array}{c} \text{---} \\ \text{---} \\ \text{---} \\ | \end{array} \mapsto \text{id}: M_{k+1} \rightarrow M_{k+1}, \quad \begin{array}{c} | \\ \text{---} \\ | \end{array} \begin{array}{c} \text{---} \\ \text{---} \\ \text{---} \\ | \end{array} \begin{array}{c} \text{---} \\ \text{---} \\ \text{---} \\ | \end{array} \mapsto \begin{pmatrix} \text{id} & 0 \\ 0 & \text{id} \end{pmatrix}: \tilde{M}_k \rightarrow \tilde{M}_k$$

For the up dotted edge we assign (recalling the rescaling  $\tilde{\varepsilon}_k = 2^k \varepsilon_k$ )

$$\begin{array}{c} | \\ \cdot \\ | \end{array} \begin{array}{c} \text{---} \\ \text{---} \\ \text{---} \\ | \end{array} \begin{array}{c} \text{---} \\ \text{---} \\ \text{---} \\ | \end{array} \mapsto u_k: M_k \rightarrow M_{k+1}, \quad \begin{array}{c} | \\ \cdot \\ | \end{array} \begin{array}{c} \text{---} \\ \text{---} \\ \text{---} \\ | \end{array} \begin{array}{c} \text{---} \\ \text{---} \\ \text{---} \\ | \end{array} \mapsto \begin{pmatrix} \tilde{\varepsilon}_k \\ \text{id} \end{pmatrix}: M_k \rightarrow \tilde{M}_k$$

For the down dotted edge we assign (recalling the rescaling  $\tilde{d}_k = 2^k d_k$ )

$$\begin{array}{c} \cdot \\ | \end{array} \begin{array}{c} \text{---} \\ \text{---} \\ \text{---} \\ | \end{array} \begin{array}{c} \text{---} \\ \text{---} \\ \text{---} \\ | \end{array} \mapsto \tilde{d}_{k+1}: M_{k+1} \rightarrow M_k, \quad \begin{array}{c} \cdot \\ | \end{array} \begin{array}{c} \text{---} \\ \text{---} \\ \text{---} \\ | \end{array} \begin{array}{c} \text{---} \\ \text{---} \\ \text{---} \\ | \end{array} \mapsto \begin{pmatrix} \text{id} & \tilde{\varepsilon}_k \end{pmatrix}: \tilde{M}_k \rightarrow M_k$$

For the merges and splits in the even case we assign

$$\begin{array}{c} \cdot \\ \cdot \\ \cdot \\ | \end{array} \begin{array}{c} \text{---} \\ \text{---} \\ \text{---} \\ | \end{array} \begin{array}{c} \text{---} \\ \text{---} \\ \text{---} \\ | \end{array} \mapsto \begin{pmatrix} 0 & \text{id} \end{pmatrix}: \tilde{M}_{k+1} \rightarrow M_{k+1}, \quad \begin{array}{c} \cdot \\ \cdot \\ \cdot \\ | \end{array} \begin{array}{c} \text{---} \\ \text{---} \\ \text{---} \\ | \end{array} \begin{array}{c} \text{---} \\ \text{---} \\ \text{---} \\ | \end{array} \mapsto \begin{pmatrix} \text{id} \\ 0 \end{pmatrix}: M_{k+1} \rightarrow \tilde{M}_{k+1}$$

For the merges in the odd case we assign

$$\begin{array}{c} \cdot \\ \cdot \\ \cdot \\ | \end{array} \begin{array}{c} \text{---} \\ \text{---} \\ \text{---} \\ | \end{array} \begin{array}{c} \text{---} \\ \text{---} \\ \text{---} \\ | \end{array} \mapsto \begin{pmatrix} 0 & 0 & \text{id} & 0 \\ 0 & 0 & 0 & \text{id} \end{pmatrix}: \tilde{M}_k \rightarrow \tilde{M}_k$$

(with  $\tilde{M}_k = M_k\langle -2 \rangle \oplus M_k\langle 0 \rangle \oplus M_k\langle 0 \rangle \oplus M_k\langle +2 \rangle$ ) and last but not least

$$\begin{array}{c} \cdot \\ \cdot \\ \cdot \\ | \end{array} \begin{array}{c} \text{---} \\ \text{---} \\ \text{---} \\ | \end{array} \begin{array}{c} \text{---} \\ \text{---} \\ \text{---} \\ | \end{array} \mapsto \begin{pmatrix} \text{id} & 0 \\ 0 & \text{id} \\ 0 & 0 \\ 0 & 0 \end{pmatrix}: \tilde{M}_k \rightarrow \tilde{M}_k.$$

- “Fill up the generators to the left”: for each red identity strand to the left of the local generators from above apply a  $\Theta_s$  to the elements of the matrices component-wise and likewise for green strands and  $\Theta_t$ . This can be made explicit as explained in Example 3.15.
- If  $f$  is a homomorphism  $f \in \text{Hom}(\widehat{\mathfrak{SD}}(\infty))$ , then decompose it into generators and define  $\mathcal{D}_\infty(f)$  to be the composition of its local pieces.

We extend linearly for a general  $F \in \text{Hom}(\text{Mat}(\widehat{\mathfrak{SD}}(\infty)))$ . ▲

**Example 4.25.** It is easy to see how the assignment is for alternating sequences. For example

$$\begin{array}{c} \bullet \\ | \\ \text{---} \\ | \\ \text{---} \end{array} \mapsto u_0: T_q(\mathbf{0}) \rightarrow T_q(\mathbf{1}), \quad \begin{array}{c} \bullet \\ | \\ \text{---} \\ | \\ \text{---} \end{array} \mapsto \tilde{d}_1: T_q(\mathbf{1}) \rightarrow T_q(\mathbf{0})$$

and similar for all other diagrams of this kind. Furthermore, we have

$$\begin{array}{c} \text{---} \\ | \\ \text{---} \\ | \\ \text{---} \end{array} \mapsto (0 \quad \text{id}) : T_q(\mathbf{1})\langle -1 \rangle \oplus T_q(\mathbf{1})\langle +1 \rangle \rightarrow T_q(\mathbf{1})$$

$$\begin{array}{c} \text{---} \\ | \\ \text{---} \\ | \\ \text{---} \end{array} \mapsto \begin{pmatrix} \text{id} \\ 0 \end{pmatrix} : T_q(\mathbf{1}) \rightarrow T_q(\mathbf{1})\langle -1 \rangle \oplus T_q(\mathbf{1})\langle +1 \rangle$$

where we see that the degree is preserved. Moreover, the entries in the matrices of the list above are in general already matrices. For example, the matrix that corresponds to (here  $M_1 = T_q(\mathbf{1})$ )

$$\begin{array}{c} \bullet \\ | \\ | \\ | \\ \text{---} \end{array} \mapsto \begin{pmatrix} \text{id} & \tilde{\varepsilon}_1 & 0 & 0 \\ 0 & 0 & \text{id} & \tilde{\varepsilon}_1 \end{pmatrix} : \tilde{M}_1 \rightarrow \tilde{M}_1$$

Likewise for the horizontally flipped diagram. ▲

**Lemma 4.26.**  $\mathcal{D}_\infty: \text{Mat}(\widehat{\mathfrak{SD}}(\infty)) \rightarrow \mathfrak{T}_\lambda^{\text{gr}}$  is well-defined,  $\mathbb{Q}(q)$ -linear and degree preserving.  $\square$

*Proof.* It is immediate that  $\mathcal{D}_\infty$  is  $\mathbb{Q}(q)$ -linear and degree preserving.

Moreover, note that, by part (b) of Corollary 2.35 and part (c) of Corollary 3.25, the assignment is well-defined on objects  $x$ , since we send  $x$  to a repeated application of  $\Theta_s$  and  $\Theta_t$  to the trivial  $U_q$ -module  $T_q(\mathbf{0})$  together with a projection onto the leading factor  $T_q(\mathbf{i})$ . Thus, without taking relations into account, we get a well-defined functor from  $\text{Mat}(\mathfrak{D}(\infty)_f)$  to  $\mathfrak{T}_\lambda^{\text{gr}}$  since our assignment for the generating Soergel diagrams are all  $U_q$ -intertwiners.

Thus, the main part is to show that the relations are satisfied. This is now a case-by-case check where we only do a few as examples and leave the rest to the reader.

**Frobenius and isotopy relations:** we do not have to check the Frobenius relations **Frob1** and **Frob2** (18) and the isotopy relations **Iso1** and **Iso2** (21), since, by part (a) of Corollary 3.25, we see that  $\Theta_s$  and  $\Theta_t$  are (graded) self-adjoint functors. By a more general principle such functors always give rise to a Frobenius structure, see e.g. [46, Lemma 3.4].

**Needle:** for simplicity of notation, we assume that we are in the even case. We show

$$\mathcal{D}_\infty \left( \begin{array}{c} | \\ | \\ \text{---} \\ | \\ | \\ | \end{array} \right) = 0$$

This follows from

$$M_{k+1} \xrightarrow{\begin{pmatrix} \text{id} \\ 0 \end{pmatrix}} \tilde{M}_{k+1} \xrightarrow{\begin{pmatrix} 0 & \text{id} \end{pmatrix}} M_{k+1}$$

The odd case is similar. This clearly implies the needle relation.

**The dead-end relations 1+2: DE1** follows by construction. The **DE2** relation is

$$\mathcal{D}_\infty \left( \begin{array}{c} \bullet \\ | \\ \circ \\ | \\ \bullet \\ | \end{array} \begin{array}{c} \text{---} \\ | \\ | \end{array} \right) = 0$$

This follows from

$$T_q(\mathbf{0}) \xrightarrow{u_0} T_q(\mathbf{1}) \xrightarrow{\tilde{d}_1} T_q(\mathbf{0})$$

which is the dead-end relation in the tilting case.

**Barbell forcing 1:** we only do one case (the one with equal colors) and leave the other (similar) case to the reader. Again, for simplicity of notation, we focus on

$$\mathcal{D}_\infty \left( \begin{array}{c} \bullet \\ | \\ \circ \\ | \\ \bullet \\ | \end{array} \begin{array}{c} | \\ | \\ | \\ | \\ | \end{array} \begin{array}{c} \text{---} \\ | \\ | \end{array} \right) = 2 \cdot \mathcal{D}_\infty \left( \begin{array}{c} \bullet \\ | \\ \circ \\ | \\ \bullet \\ | \end{array} \begin{array}{c} | \\ | \\ | \\ | \\ | \end{array} \begin{array}{c} \text{---} \\ | \\ | \end{array} \right) - \mathcal{D}_\infty \left( \begin{array}{c} | \\ | \\ | \\ | \\ | \end{array} \begin{array}{c} \bullet \\ | \\ \circ \\ | \\ \bullet \\ | \end{array} \begin{array}{c} \text{---} \\ | \\ | \end{array} \right)$$

The general case follows completely similar. We have already explained in Example 4.25 how to obtain the left two matrices. Thus, we obtain

$$\begin{pmatrix} \text{id} & \varepsilon_1 & 0 & 0 \\ 0 & 0 & \text{id} & \tilde{\varepsilon}_1 \end{pmatrix} \circ \begin{pmatrix} \varepsilon_1 & 0 \\ \text{id} & 0 \\ 0 & \tilde{\varepsilon}_1 \\ 0 & \text{id} \end{pmatrix} = \begin{pmatrix} 2\tilde{\varepsilon}_1 & 0 \\ 0 & 2\tilde{\varepsilon}_1 \end{pmatrix}$$

for the left side. The middle (without the factor 2) can be directly read off as

$$\begin{pmatrix} \tilde{\varepsilon}_1 \\ \text{id} \end{pmatrix} \circ \begin{pmatrix} \text{id} & \tilde{\varepsilon}_1 \end{pmatrix} = \begin{pmatrix} \tilde{\varepsilon}_1 & 0 \\ \text{id} & \tilde{\varepsilon}_1 \end{pmatrix}$$

The rightmost term is the result of applying  $\Theta_t$  to  $2\tilde{\varepsilon}_1$  (which is the composite of the diagram for the first two strands). This can be computed as explained in Section 3. Thus, we obtain

$$\begin{pmatrix} 2\tilde{\varepsilon}_1 & 0 \\ 0 & 2\tilde{\varepsilon}_1 \end{pmatrix} = 2 \cdot \begin{pmatrix} \tilde{\varepsilon}_1 & 0 \\ \text{id} & \tilde{\varepsilon}_1 \end{pmatrix} - \begin{pmatrix} 0 & 0 \\ 2 \cdot \text{id} & 0 \end{pmatrix}$$

**Barbell forcing 2:** this is very similar to **BF1** (only two terms are different) and we only sketch it here. As before we only consider one particular case (the same as above for **BF1**) and leave the others for the reader to verify. The different two terms are now

$$\mathcal{D}_\infty \left( \begin{array}{c} \left( \begin{array}{c} \text{red bar} \\ \text{red dot} \\ \text{red bar} \end{array} \right) \\ \text{green circle} \\ \text{green bar} \\ \text{green bar} \\ \text{red bar} \end{array} \right), \quad \mathcal{D}_\infty \left( \begin{array}{c} \text{green bar} \\ \text{green bar} \\ \text{red dot} \\ \text{green circle} \\ \text{red bar} \end{array} \right)$$

These two cases give the matrices

$$\begin{pmatrix} 2 \cdot \tilde{\varepsilon}_1 & 0 \\ 0 & 2 \cdot \tilde{\varepsilon}_1 \end{pmatrix} \quad \text{and} \quad \begin{pmatrix} 0 & 0 \\ 2 \cdot \text{id} & 0 \end{pmatrix}$$

and the equation **BF2** (20) then reads as

$$\begin{pmatrix} 2 \cdot \tilde{\varepsilon}_1 & 0 \\ 0 & 2 \cdot \tilde{\varepsilon}_1 \end{pmatrix} = \begin{pmatrix} 0 & 0 \\ 2 \cdot \text{id} & 0 \end{pmatrix} + 2 \begin{pmatrix} \tilde{\varepsilon}_1 & 0 \\ \text{id} & \tilde{\varepsilon}_1 \end{pmatrix} - 2 \begin{pmatrix} 0 & 0 \\ 2 \cdot \text{id} & 0 \end{pmatrix}$$

This finishes the proof. ■

**Theorem 4.27. (Diagram categories for  $\mathfrak{T}_\lambda^{\text{gr}}$ )** The functor  $\mathcal{D}_\infty: \text{Mat}(\widehat{\mathfrak{QD}}(\infty)) \rightarrow \mathfrak{T}_\lambda^{\text{gr}}$  is an equivalence of graded categories. □

*Proof.* We have to show that  $\mathcal{D}_\infty$  is essentially surjective, full and faithful.

**Essentially surjective:** we have to show that, given some arbitrary object  $M \in \text{Ob}(\mathfrak{T}_\lambda^{\text{gr}})$ , then there is an object  $x \in \text{Ob}(\text{Mat}(\widehat{\mathfrak{QD}}(\infty)))$  such that  $\mathcal{D}_\infty(x) \cong M$ . To see this, note that, by part (c) of Proposition 2.20, it is enough to verify this for indecomposable  $U_q$ -modules  $T_q(\mathbf{i})$  in the ungraded setting (using Proposition 3.19 the same is still true in the graded setting). Now, because of our construction and part (b) of Corollary 2.35, we see that  $\mathcal{D}_\infty(x_{i-tst}) \cong T_q(\mathbf{i})$  which shows that the functor is essentially surjective.

**Fully faithful:** by Lemmas 4.11 and 4.26 it is enough to show that

$$\text{Hom}_{\text{Mat}(\widehat{\mathfrak{QD}}(\infty))}(x, x') \cong \text{Hom}_{\mathfrak{T}_\lambda^{\text{gr}}}(\mathcal{D}_\infty(x), \mathcal{D}_\infty(x'))$$

holds as graded  $\mathbb{Q}(q)$ -vector spaces for alternating sequences  $x = x_{i-tst}$  and  $x' = x'_{i'-tst}$ . We have already computed both sides: the right side was computed in Corollary 2.31 and the left in Corollary 4.21. By our construction, the (graded) isomorphism is induced by the assignment  $\mathbf{i} \mapsto \mathbf{i}$ ,  $u_i \mapsto u_i$ ,  $d_i \mapsto \tilde{d}_i$  and  $\varepsilon_i \mapsto \tilde{\varepsilon}_i$  whenever this makes sense. ■

**Corollary 4.28.** The category  $\text{Mat}(\widehat{\mathfrak{QD}}(\infty))$  is idempotent complete. □

*Proof.* This follows from Theorem 4.27 because in  $\mathfrak{T}_\lambda^{\text{gr}} \cong \mathfrak{T}_\lambda$  every module decomposes into a direct sum of (shifted copies of)  $T_q(\mathbf{i})$ 's. ■

**Corollary 4.29. (Diagram categories for the center)** The graded  $\mathbb{Q}(q)$ -algebra  $\text{End}_{\text{gr}}^{\text{fs}}(\text{id})$  of natural transformations in  $p\text{End}(\mathfrak{T}_\lambda^{\text{gr}})$  of the identity functor  $\text{id}$  is given by the diagonal part of finitely supported (only a finite number of non-zero entries) matrices

$$(26) \quad F: \emptyset \oplus g \oplus rg \oplus grg \oplus rgrg \oplus \dots \rightarrow \emptyset \oplus g \oplus rg \oplus grg \oplus rgrg \oplus \dots$$

of marked Soergel diagrams with no identity diagram entry. In contrast,  $\text{End}_{\mathbb{U}_q}^{\text{fs}}(T_q(\infty)) \cong Q_\infty$  is given by all such matrices and not just the diagonal part.  $\square$

*Proof.* An alternating sequence of red and green of length  $i$  corresponds under the equivalence from Theorem 4.27 to  $T_q(\mathbf{i})$ , since, by Proposition 4.23, the quiver relations are satisfied. This module corresponds under the isomorphisms from Corollary 3.28 to  ${}_i P$ . Thus, the claim follows by Theorem 4.27 and Proposition 3.27, since (graded) equivalent categories have (graded) isomorphic centers and the observation that an  $F$  as in (26) is a natural transformation iff it commutes with all other such  $F$ 's (compare also to (28)). That the center of the matrix ring is as stated above is then an easy to deduce fact: the  $\mathbf{i}$  are not central (as already noted after Definition 3.1), while the  $\varepsilon_i$  compose with everything to zero (and are therefore in the center).  $\blacksquare$

**Remark 4.30.** Relaxing the conditions to work over another field and not  $\mathbb{Q}(q)$  is actually a problem in Section 2 since the indecomposable tilting modules and their hom-spaces are much more complicated in positive characteristic. For the KS quiver algebras from Section 3 working over  $\mathbb{Z}$  is not a huge problem, while for the diagrammatic category  $\widehat{\mathfrak{QD}}(\infty)$  we need to work over  $\mathbb{Q}$ .  $\blacktriangle$

**4.5. Diagram categories for  $p\text{End}(\mathfrak{T}_\lambda^{\text{gr}})$ .** We denote by  $\overline{\text{Mat}}(\mathcal{C})$  literally the same category as  $\text{Mat}(\mathcal{C})$ , but we allow *countable* direct sums as objects and *finitely supported* matrices as morphisms. We carefully distinguish between red  $r$  and green  $g$  on one hand and  $s, t \in W_l$  on the other. We think of an *alternating* sequence (of length  $i \geq 0$ ) of the former  $x_{i-\text{gr}g}$  to correspond (under Theorem 4.27) to  $T_q(\mathbf{i})$  and of *any* sequence of the latter  $x = x_i \dots x_2 x_1$  to correspond to  $\Theta_x = \Theta_{x_i} \circ \dots \circ \Theta_{x_1}$ . Using this interpretation, we are going to make Proposition 3.27 explicit. We define  $\vec{\circ}$  to be the sequence of alternating  $x_{i-\text{gr}g}$  sequences

$$\vec{\circ} = (\dots, rgrg, grg, rg, g, \emptyset), \quad \vec{\circ}_i = x_{i-\text{gr}g} \quad \text{for } i = 0, 1, \dots,$$

where we read the vector from right to left.

Moreover, given a finite sequence  $x = x_i \dots x_2 x_1$  with  $x_i \in \{s, t\}$  we define

$$x \cdot \vec{\circ} = (\dots, xrgrg, xgrg, xrg, xg, x), \quad (x \cdot \vec{\circ})_i = xx_{i-\text{gr}g} \quad \text{for } i = 0, 1, \dots,$$

where each entry is given by concatenation. In addition, we define

$$xx_{i-\text{gr}g} = \bigoplus_{i'} x_{i'-\text{gr}g}^{m_{i'}} \langle s_{i'} \rangle$$

where the multiplicity  $m_{i'}$  is the multiplicity of  $T_q(\mathbf{i}')$  in  $\Theta_x(T_q(\mathbf{i}))$  given inductively by part c of Corollary 3.25 (from where we also get the shifts  $s_{i'}$ ). Thus, we see  $xx_{i-\text{gr}g}$  as an object  $\text{Ob}(\overline{\text{Mat}}(\widehat{\mathfrak{QD}}(\infty)))$ . Note that  $xx_{0-\text{gr}g} = 0$  if  $x$  starts with  $r$  because of  $\Theta_s(T_q(0)) = 0$ .

**Definition 4.31.** Denote by  $\text{Mat}_\infty^{\text{fs}}(\widehat{\mathfrak{QD}}(\infty))$  the  $\mathbb{Q}(q)$ -linear, graded category consisting of:

- Objects  $\text{Ob}(\text{Mat}_\infty^{\text{fs}}(\widehat{\mathfrak{QD}}(\infty)))$  are finite sequences  $x = x_i \dots x_2 x_1$  with  $x_i \in \{s, t\}$  (plus shifts). Moreover, the empty sequence  $\emptyset$  is also an object.
- The space of morphisms  $\text{Hom}_{\text{Mat}_\infty^{\text{fs}}(\widehat{\mathfrak{QD}}(\infty))}(x, x')$  for  $x, x' \in \text{Ob}(\text{Mat}_\infty^{\text{fs}}(\widehat{\mathfrak{QD}}(\infty)))$  is the  $\mathbb{Q}(q)$ -linear span of finitely supported (only a finite number of non-zero entries) matrices

$$F = (F_{k'k})_{k, k' \in \mathbb{Z}_{\geq 0}} \in \text{Hom}_{\overline{\text{Mat}}(\widehat{\mathfrak{QD}}(\infty))}(x \cdot \vec{\circ}, x' \cdot \vec{\circ})$$

of marked Soergel graphs  $F_{k'k}: (x \cdot \vec{\circ})_k \rightarrow (x' \cdot \vec{\circ})_{k'}$ .

- The diagonal part of  $F$  consists of matrices  $F^i: (x \cdot \vec{\circ})_i \rightarrow (x' \cdot \vec{\circ})_i$ .
- Composition of morphisms is multiplication of matrices.

The spaces  $\text{Hom}_{\text{Mat}_{\infty}^{\text{fs}}(\widehat{\mathfrak{D}}(\infty))}(x, x')$  are graded  $\mathbb{Q}(q)$ -vector spaces where the degree is given by  $l(F_{k'k})$  (the degree or length from Definition 4.5) for each entry of matrices  $F$ .  $\blacktriangle$

Denote by  $p\text{End}_{\Theta}^{\text{fs}}(\mathfrak{T}_{\lambda}^{\text{gr}})$  the full subcategory of  $p\text{End}(\mathfrak{T}_{\lambda}^{\text{gr}})$  consisting of only compositions of  $\Theta_s$  and  $\Theta_t$  (together with the condition of being finitely supported). Note that, by Proposition 2.39, we have

$$\text{Kar}(p\text{End}_{\Theta}^{\text{fs}}(\mathfrak{T}_{\lambda}^{\text{gr}})) \cong p\text{End}^{\text{fs}}(\mathfrak{T}_{\lambda}^{\text{gr}}).$$

Moreover, we denote by  $\text{Mat}_{\infty}^{\text{fs}}(\widehat{\mathfrak{D}}(\infty))_c$  the subcategory of  $\text{Mat}_{\infty}^{\text{fs}}(\widehat{\mathfrak{D}}(\infty))$  whose hom-spaces are

$$(27) \quad \text{Hom}_{\text{Mat}_{\infty}^{\text{fs}}(\widehat{\mathfrak{D}}(\infty))_c}(x, x') = \{F \in \text{Hom}_{\text{Mat}_{\infty}^{\text{fs}}(\widehat{\mathfrak{D}}(\infty))}(x, x') \mid FG = G'F\},$$

for  $G \in \text{Hom}_{\text{Mat}_{\infty}^{\text{fs}}(\widehat{\mathfrak{D}}(\infty))}(x, x)$  and  $G' \in \text{Hom}_{\text{Mat}_{\infty}^{\text{fs}}(\widehat{\mathfrak{D}}(\infty))}(x', x')$  such that entry-wise there exists an  $U_q$ -intertwiner  $f: M \rightarrow M'$  with  $\mathcal{D}_{\infty}(G_{i'i}) = \Theta_x(f)$  and  $\mathcal{D}_{\infty}(G'_{i'i}) = \Theta_{x'}(f)$ . The reader may check that  $\text{Mat}_{\infty}^{\text{fs}}(\widehat{\mathfrak{D}}(\infty))_c$  is really a subcategory.

**Definition 4.32.** We define a functor

$$\mathcal{D}^{\infty}: p\text{End}_{\Theta}^{\text{fs}}(\mathfrak{T}_{\lambda}^{\text{gr}}) \rightarrow \text{Mat}_{\infty}^{\text{fs}}(\widehat{\mathfrak{D}}(\infty))_c$$

on objects (we treat shifts again in the evident way) and morphisms as

$$\Theta_x \mapsto x, \quad \text{and} \quad \eta: \Theta_x \rightarrow \Theta_{x'}, \quad \eta_{T_q(\mathbf{i})}: \Theta_x T_q(\mathbf{i}) \rightarrow \Theta_{x'} T_q(\mathbf{i}) \mapsto \text{diag}(F) = (F^i)_{i \in \mathbb{Z}_{\geq 0}}: x \rightarrow x',$$

where  $\text{diag}(F)$  is a diagonal matrix consisting of the various  $F^i$ 's and, for each  $\mathbf{i}$ , the matrix of marked Soergel diagrams  $F^i$  is component-wise given by  $\mathbf{i} \mapsto \mathbf{i}$ ,  $u_i \mapsto u_i$ ,  $d_i \mapsto d_i$  and  $\varepsilon_i \mapsto \varepsilon_i$  for all suitable indices  $i$  and marked Soergel diagrams as in Corollary 4.21.  $\blacktriangle$

**Lemma 4.33.** The functor  $\mathcal{D}^{\infty}: p\text{End}_{\Theta}^{\text{fs}}(\mathfrak{T}_{\lambda}^{\text{gr}}) \rightarrow \text{Mat}_{\infty}^{\text{fs}}(\widehat{\mathfrak{D}}(\infty))_c$  is a well-defined functor between  $\mathbb{Q}(q)$ -linear, graded categories.  $\square$

*Proof.* The  $\mathbb{Q}(q)$ -linearity is clear. In addition, the assignment is clearly degree preserving and well-defined component-wise (since the quiver relations are satisfied, see Proposition 4.23).

To see that it is well-defined note that  $\eta_{T_q(\mathbf{i})}$  is a matrix consisting of  $U_q$ -intertwiners between the direct summands of  $\Theta_x T_q(\mathbf{i})$  and  $\Theta_{x'} T_q(\mathbf{i})$  (for each  $T_q(\mathbf{i})$ ). These are sums of  $\mathbf{i}$ ,  $u_i$ ,  $d_i$  and  $\varepsilon_i$  by the isomorphism of Proposition 3.10. To see that the relations are satisfied, note that, given any  $U_q$ -intertwiner  $f: M \rightarrow M'$ , the naturality of a transformation  $\eta: \Theta_x \rightarrow \Theta_{x'}$  says that

$$(28) \quad \begin{array}{ccc} \Theta_x M & \xrightarrow{\Theta_x f} & \Theta_x M' \\ \eta_M \downarrow & & \downarrow \eta_{M'} \\ \Theta_{x'} M & \xrightarrow{\Theta_{x'} f} & \Theta_{x'} M' \end{array}$$

commutes. Thus, the matrices coming from our assignment satisfy the condition (27).  $\blacksquare$

**Theorem 4.34. (Diagram categories for  $p\text{End}(\mathfrak{T}_\lambda^{\text{gr}})$ )** The functor  $\mathcal{D}^\infty$  is a graded equivalence.  $\square$

*Proof.* As in Theorem 4.27, we have to show that  $\mathcal{D}^\infty$  is essentially surjective, full and faithful.

That  $\mathcal{D}^\infty$  is essentially surjective follows from the definition of the objects in  $\text{Mat}_\infty^{\text{fs}}(\widehat{\mathfrak{QD}}(\infty))_d$ . That it is faithful is a direct consequence of Proposition 3.27 combined with Theorem 4.27. That  $\mathcal{D}^\infty$  is full is just a direct comparison of (27) and (28).  $\blacksquare$

**Remark 4.35.** A possible generalization of our diagrammatic categories could follow from work of Elias and Libedinsky on Coxeter groups, see [20]. The underlying Coxeter group  $W$  will for  $A_n$  be the affine Weyl group, that is, the one given by the cyclic Dynkin diagram with  $n + 1$ -nodes

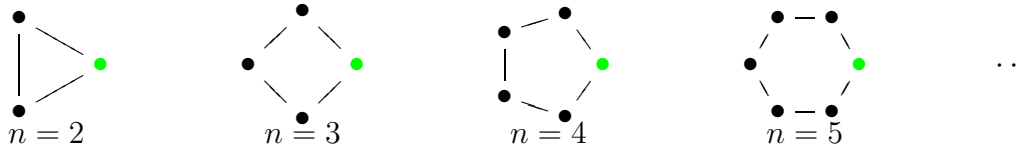

where the green (rightmost) nodes indicate the affine nodes.  $\blacktriangle$

## REFERENCES

- [1] H.H. Andersen. Tensor products of quantized tilting modules. *Comm. Math. Phys.*, 149(1):149–159, 1992. URL: <http://projecteuclid.org/euclid.cmp/1104251142>.
- [2] H.H. Andersen. The strong linkage principle for quantum groups at roots of 1. *J. Algebra*, 260(1):2–15, 2003. doi:10.1016/S0021-8693(02)00618-X.
- [3] H.H. Andersen, J.C. Jantzen, and W. Soergel. Representations of quantum groups at a  $p$ th root of unity and of semisimple groups in characteristic  $p$ : independence of  $p$ . *Astérisque*, (220):321, 1994.
- [4] H.H. Andersen and M. Kaneda. Rigidity of tilting modules. *Mosc. Math. J.*, 11(1):1–39, 181, 2011. URL: <http://arxiv.org/abs/0909.2935>.
- [5] H.H. Andersen, P. Polo, and K.X. Wen. Representations of quantum algebras. *Invent. Math.*, 104(1):1–59, 1991. doi:10.1007/BF01245066.
- [6] I. Assem, D. Simson, and A. Skowroński. *Elements of the representation theory of associative algebras. Vol. 1*, volume 65 of *London Mathematical Society Student Texts*. Cambridge University Press, Cambridge, 2006. Techniques of representation theory. doi:10.1017/CBO9780511614309.
- [7] A. Beilinson, V. Ginzburg, and W. Soergel. Koszul duality patterns in representation theory. *J. Amer. Math. Soc.*, 9(2):473–527, 1996. doi:10.1090/S0894-0347-96-00192-0.
- [8] J. Bernstein, I. Frenkel, and M. Khovanov. A categorification of the Temperley-Lieb algebra and Schur quotients of  $U(\mathfrak{sl}_2)$  via projective and Zuckerman functors. *Selecta Math. (N.S.)*, 5(2):199–241, 1999. URL: <http://arxiv.org/abs/math/0002087>, doi:10.1007/s000290050047.
- [9] J.N. Bernstein and S.I. Gel’fand. Tensor products of finite- and infinite-dimensional representations of semisimple Lie algebras. *Compositio Math.*, 41(2):245–285, 1980. URL: [http://www.numdam.org/item?id=CM\\_1980\\_\\_41\\_2\\_245\\_0](http://www.numdam.org/item?id=CM_1980__41_2_245_0).
- [10] T. Braden. Perverse sheaves on Grassmannians. *Canad. J. Math.*, 54(3):493–532, 2002. URL: <http://arxiv.org/abs/math/9907152>, doi:10.4153/CJM-2002-017-6.
- [11] J. Brundan and C. Stroppel. Gradings on walled Brauer algebras and Khovanov’s arc algebra. *Adv. Math.*, 231(2):709–773, 2012. URL: <http://arxiv.org/abs/1107.0999>, doi:10.1016/j.aim.2012.05.016.
- [12] J. Brundan and C. Stroppel. Highest weight categories arising from Khovanov’s diagram algebra I: cellularity. *Mosc. Math. J.*, 11(4):685–722, 821–822, 2011. URL: <http://arxiv.org/abs/0806.1532>.
- [13] J. Brundan and C. Stroppel. Highest weight categories arising from Khovanov’s diagram algebra II: Koszulity. *Transform. Groups*, 15(1):1–45, 2010. URL: <http://arxiv.org/abs/0806.3472>, doi:10.1007/s00031-010-9079-4.
- [14] J. Brundan and C. Stroppel. Highest weight categories arising from Khovanov’s diagram algebra III: category  $\mathcal{O}$ . *Represent. Theory*, 15:170–243, 2011. URL: <http://arxiv.org/abs/0812.1090>, doi:10.1090/S1088-4165-2011-00389-7.



- [15] J. Brundan and C. Stroppel. Highest weight categories arising from Khovanov’s diagram algebra IV: the general linear supergroup. *J. Eur. Math. Soc. (JEMS)*, 14(2):373–419, 2012. URL: <http://arxiv.org/abs/0907.2543>, doi:10.4171/JEMS/306.
- [16] Y. Chen and M. Khovanov. An invariant of tangle cobordisms via subquotients of arc rings. *Fund. Math.*, 225(1):23–44, 2014. URL: <http://arxiv.org/abs/math/0610054>, doi:10.4064/fm225-1-2.
- [17] S. Donkin. On tilting modules for algebraic groups. *Math. Z.*, 212(1):39–60, 1993. doi:10.1007/BF02571640.
- [18] B. Elias. The two-color Soergel calculus. URL: <http://arxiv.org/abs/1308.6611>.
- [19] B. Elias and M. Khovanov. Diagrammatics for Soergel categories. *Int. J. Math. Math. Sci.*, pages Art. ID 978635, 58, 2010. URL: <http://arxiv.org/abs/0902.4700>.
- [20] B. Elias and N. Libedinsky. Soergel bimodules for universal Coxeter groups. URL: <http://arxiv.org/abs/1401.2467>.
- [21] B. Elias and G. Williamson. Diagrammatics for Coxeter groups and their braid groups. URL: <http://arxiv.org/abs/1405.4928>.
- [22] B. Elias and G. Williamson. Soergel calculus. URL: <http://arxiv.org/abs/1309.0865>.
- [23] B. Elias and G. Williamson. The Hodge theory of Soergel bimodules. *Ann. of Math. (2)*, 180(3):1089–1136, 2014. URL: <http://arxiv.org/abs/1212.0791>, doi:10.4007/annals.2014.180.3.6.
- [24] J.E. Humphreys. *Representations of semisimple Lie algebras in the BGG category  $\mathcal{O}$* , volume 94 of *Graduate Studies in Mathematics*. American Mathematical Society, Providence, RI, 2008. doi:10.1090/gsm/094.
- [25] J.C. Jantzen. *Lectures on quantum groups*, volume 6 of *Graduate Studies in Mathematics*. American Mathematical Society, Providence, RI, 1996.
- [26] J.C. Jantzen. *Representations of algebraic groups*, volume 107 of *Mathematical Surveys and Monographs*. American Mathematical Society, Providence, RI, second edition, 2003.
- [27] A. Joyal and R. Street. The geometry of tensor calculus. I. *Adv. Math.*, 88(1):55–112, 1991. doi:10.1016/0001-8708(91)90003-P.
- [28] M. Kashiwara and T. Tanisaki. Kazhdan-Lusztig conjecture for affine Lie algebras with negative level. *Duke Math. J.*, 77(1):21–62, 1995. doi:10.1215/S0012-7094-95-07702-3.
- [29] D. Kazhdan and G. Lusztig. Tensor structures arising from affine Lie algebras. I, II, III, IV. *J. Amer. Math. Soc.*, 6,7(4,2):905–947, 949–1011, 335–381, 383–453, 1993,1994.
- [30] M. Khovanov. A categorification of the Jones polynomial. *Duke Math. J.*, 101(3):359–426, 2000. URL: <http://arxiv.org/abs/math/9908171>, doi:10.1215/S0012-7094-00-10131-7.
- [31] M. Khovanov. A functor-valued invariant of tangles. *Algebr. Geom. Topol.*, 2:665–741, 2002. URL: <http://arxiv.org/abs/math/0103190>, doi:10.2140/agt.2002.2.665.
- [32] M. Khovanov. Categorifications from planar diagrammatics. *Jpn. J. Math.*, 5(2):153–181, 2010. URL: <http://arxiv.org/abs/1008.5084>, doi:10.1007/s11537-010-0925-x.
- [33] M. Khovanov and A.D. Lauda. A categorification of quantum  $\mathfrak{sl}_n$ . *Quantum Topol.*, 1(1):1–92, 2010. URL: <http://arxiv.org/abs/0807.3250>, doi:10.4171/QT/1.
- [34] M. Khovanov, A.D. Lauda, M. Mackaay, and M. Stošić. Extended graphical calculus for categorified quantum  $\mathfrak{sl}(2)$ . *Mem. Amer. Math. Soc.*, 219(1029):vi+87, 2012. URL: <http://arxiv.org/abs/1006.2866>, doi:10.1090/S0065-9266-2012-00665-4.
- [35] M. Khovanov and L. Rozansky. Matrix factorizations and link homology. *Fund. Math.*, 199(1):1–91, 2008. URL: <http://arxiv.org/abs/math/0401268>, doi:10.4064/fm199-1-1.
- [36] M. Khovanov and P. Seidel. Quivers, Floer cohomology, and braid group actions. *J. Amer. Math. Soc.*, 15(1):203–271, 2002. URL: <http://arxiv.org/abs/math/0006056>, doi:10.1090/S0894-0347-01-00374-5.
- [37] A.D. Lauda. An introduction to diagrammatic algebra and categorified quantum  $\mathfrak{sl}_2$ . *Bull. Inst. Math. Acad. Sin. (N.S.)*, 7(2):165–270, 2012. URL: <http://arxiv.org/abs/1106.2128>.
- [38] A.D. Lauda, H. Queffelec, and D.E.V. Rose. Khovanov homology is a skew Howe 2-representation of categorified quantum  $\mathfrak{sl}(m)$ . *Algebr. Geom. Topol.*, 15(5):2517–2608, 2015. URL: <http://arxiv.org/abs/1212.6076>, doi:10.2140/agt.2015.15.2517.
- [39] N. Libedinsky. Presentation of right-angled Soergel categories by generators and relations. *J. Pure Appl. Algebra*, 214(12):2265–2278, 2010. URL: <http://arxiv.org/abs/0810.2395>, doi:10.1016/j.jpaa.2010.02.026.

- [40] G. Lusztig. Modular representations and quantum groups. 82:59–77, 1989. doi:10.1090/conm/082/982278.
- [41] G. Lusztig. Quantum groups at roots of 1. *Geom. Dedicata*, 35(1-3):89–113, 1990. doi:10.1007/BF00147341.
- [42] G. Lusztig. Some problems in the representation theory of finite Chevalley groups. 37:313–317, 1980.
- [43] M. Mackaay. The  $\mathfrak{sl}_n$ -web algebras and dual canonical bases. *J. Algebra*, 409:54–100, 2014. URL: <http://arxiv.org/abs/1308.0566>, doi:10.1016/j.jalgebra.2014.02.036.
- [44] M. Mackaay, W. Pan, and D. Tubbenhauer. The  $\mathfrak{sl}_3$ -web algebra. *Math. Z.*, 277(1-2):401–479, 2014. URL: <http://arxiv.org/abs/1206.2118>, doi:10.1007/s00209-013-1262-6.
- [45] V. Mazorchuk, S. Ovsienko, and C. Stroppel. Quadratic duals, Koszul dual functors, and applications. *Trans. Amer. Math. Soc.*, 361(3):1129–1172, 2009. URL: <http://arxiv.org/abs/math/0603475>, doi:10.1090/S0002-9947-08-04539-X.
- [46] M. Müger. From subfactors to categories and topology. I. Frobenius algebras in and Morita equivalence of tensor categories. *J. Pure Appl. Algebra*, 180(1-2):81–157, 2003. URL: <http://arxiv.org/abs/math/0111204>, doi:10.1016/S0022-4049(02)00247-5.
- [47] J. Paradowski. Filtrations of modules over the quantum algebra. 56:93–108, 1994.
- [48] H. Queffelec and D.E.V. Rose. The  $\mathfrak{sl}_n$  foam 2-category: a combinatorial formulation of Khovanov-Rozansky homology via categorical skew Howe duality. URL: <http://arxiv.org/abs/1405.5920>.
- [49] C.M. Ringel. The category of modules with good filtrations over a quasi-hereditary algebra has almost split sequences. *Math. Z.*, 208(2):209–223, 1991. doi:10.1007/BF02571521.
- [50] R. Rouquier. 2-Kac-Moody algebras. URL: <http://arxiv.org/abs/0812.5023>.
- [51] S.F. Sawin. Quantum groups at roots of unity and modularity. *J. Knot Theory Ramifications*, 15(10):1245–1277, 2006. URL: <http://arxiv.org/abs/math/0308281>, doi:10.1142/S0218216506005160.
- [52] W. Soergel. Character formulas for tilting modules over Kac-Moody algebras. *Represent. Theory*, 2:432–448 (electronic), 1998. doi:10.1090/S1088-4165-98-00057-0.
- [53] W. Soergel. Kategorie  $\mathcal{O}$ , perverse Garben und Moduln über den Koinvarianten zur Weylgruppe. *J. Amer. Math. Soc.*, 3(2):421–445, 1990. doi:10.2307/1990960.
- [54] W. Soergel. Kazhdan-Lusztig polynomials and a combinatoric[s] for tilting modules. *Represent. Theory*, 1:83–114 (electronic), 1997. doi:10.1090/S1088-4165-97-00021-6.
- [55] W. Soergel. The combinatorics of Harish-Chandra bimodules. *J. Reine Angew. Math.*, 429:49–74, 1992. doi:10.1515/crll.1992.429.49.
- [56] C. Stroppel. Categorification of the Temperley-Lieb category, tangles, and cobordisms via projective functors. *Duke Math. J.*, 126(3):547–596, 2005. doi:10.1215/S0012-7094-04-12634-X.
- [57] C. Stroppel. Category  $\mathcal{O}$ : gradings and translation functors. *J. Algebra*, 268(1):301–326, 2003. doi:10.1016/S0021-8693(03)00308-9.
- [58] C. Stroppel. Tqft with corners and tilting functors in the Kac-Moody case. URL: <http://arxiv.org/abs/math/0605103>.
- [59] D. Tubbenhauer.  $\mathfrak{sl}_3$ -web bases, intermediate crystal bases and categorification. *J. Algebraic Combin.*, 40(4):1001–1076, 2014. URL: <http://arxiv.org/abs/1310.2779>, doi:10.1007/s10801-014-0518-5.
- [60] D. Tubbenhauer.  $\mathfrak{sl}_n$ -webs, categorification and Khovanov-Rozansky homologies. URL: <http://arxiv.org/abs/1404.5752>.
- [61] V.G. Turaev. *Quantum invariants of knots and 3-manifolds*, volume 18 of *de Gruyter Studies in Mathematics*. Walter de Gruyter & Co., Berlin, revised edition, 2010. doi:10.1515/9783110221848.

H.H.A.: CENTRE FOR QUANTUM GEOMETRY OF MODULI SPACES, AARHUS UNIVERSITY, NY MUNKEGADE 118, BUILDING 1530, ROOM 327, 8000 AARHUS C, DENMARK  
*E-mail address:* mathha@qgm.au.dk

D.T.: CENTRE FOR QUANTUM GEOMETRY OF MODULI SPACES, AARHUS UNIVERSITY, NY MUNKEGADE 118, BUILDING 1530, ROOM 316, 8000 AARHUS C, DENMARK  
*E-mail address:* dtubben@qgm.au.dk