

Multi-bifurcations of Wavefronts on r -corners

Takaharu Tsukada ¹

College of Humanities & Sciences, Department of Mathematics,
Nihon University

Abstract

We extend the notion of reticular Legendrian unfoldings in order to investigate multi-time bifurcations of wavefronts generated by an r -corner. We give a classification list of generic and stable bifurcations with two time parameter and give all generic figures in the plane and the space.

1 Introduction

Legendrian singularity can be found in many problems of differential geometry, calculus of variations and mathematical physics. One of the most successful their applications is the study of singularity of wavefronts. Bifurcation of wavefronts generated by a hypersurface without boundary in a smooth manifold is investigated as the theory of Legendrian unfoldings by S.Izumiya [1]. We investigated the theory of reticular Legendrian unfoldings in order to describe bifurcations of wavefronts generated by a hypersurface with an r -corner in [5]. These theories are investigated on one-parameter bifurcations of wavefronts. In this paper we investigate m -parameter bifurcations of wavefronts on an r -corner. Since almost theory can be proved by the parallel methods of [5], we give our theory along the paper and omit the details the parts which can be prove by the parallel methods.

Let us consider a m -parameter family $\{L_{\sigma,t}\}_{\sigma \subset I_r, t \in (\mathbb{R}^m, 0)}$ of contact regular r -cubic configurations on $J^1(\mathbb{R}^n, \mathbb{R})$ defined by contact embedding germs $C_t : (J^1(\mathbb{R}^n, \mathbb{R}), 0) \rightarrow J^1(\mathbb{R}^n, \mathbb{R})$ depending smoothly on $t \in (\mathbb{R}^m, 0)$ such that $C_0(0) = 0$, $L_{\sigma,t} = C_t(L_\sigma^0)$ for all $\sigma \subset I_r$, $t \in (\mathbb{R}^m, 0)$. We investigate bifurcations of wavefronts of $\{L_{\sigma,t}\}_{\sigma \subset I_r}$ around time 0. In order to realize this, we shall need to extend the notion of *reticular Legendrian unfoldings* which is defined in [5].

2 Stabilities of unfoldings

In this section we recall the theory of function germs with respect to *the reticular t - \mathcal{P} - \mathcal{K} -equivalence relation* which is developed in [3].

Let $\mathbb{H}^r = \{(x_1, \dots, x_r) \in \mathbb{R}^r | x_1 \geq 0, \dots, x_r \geq 0\}$ be an r -corner. We denote by $\mathcal{E}(r; k_1, r; k_2)$ the set of all germs at 0 of smooth maps $\mathbb{H}^r \times \mathbb{R}^{k_1} \rightarrow \mathbb{H}^r \times \mathbb{R}^{k_2}$ and set $\mathfrak{M}(r; k_1, r; k_2) = \{f \in \mathcal{E}(r; k_1, r; k_2) | f(0) = 0\}$. We denote $\mathcal{E}(r; k_1, k_2)$ for $\mathcal{E}(r; k_1, 0; k_2)$ and denote $\mathfrak{M}(r; k_1, k_2)$ for $\mathfrak{M}(r; k_1, 0; k_2)$.

If $k_2 = 1$ we write simply $\mathcal{E}(r; k)$ for $\mathcal{E}(r; k, 1)$ and $\mathfrak{M}(r; k)$ for $\mathfrak{M}(r; k, 1)$. Then $\mathcal{E}(r; k)$ is an \mathbb{R} -algebra in the usual way and $\mathfrak{M}(r; k)$ is its unique maximal ideal. We also denote by $\mathcal{E}(k)$ for $\mathcal{E}(0; k)$ and $\mathfrak{M}(k)$ for $\mathfrak{M}(0; k)$. We remark that $\mathcal{E}(r; k, p)$ is an $\mathcal{E}(r; k)$ -module generated by p -elements.

¹Higashijujo 3-1-16 Kita-ku, Tokyo 114-0001 JAPAN. e-mail : tsukada@math.chs.nihon-u.ac.jp

We denote by $J^l(r+k, p)$ the set of l -jets at 0 of germs in $\mathcal{E}(r; k, p)$. There are natural projections:

$$\pi_l : \mathcal{E}(r; k, p) \longrightarrow J^l(r+k, p), \quad \pi_{l_1}^{l_2} : J^{l_1}(r+k, p) \longrightarrow J^{l_2}(r+k, p) \quad (l_1 > l_2).$$

We write $j^l f(0)$ for $\pi_l(f)$ for each $f \in \mathcal{E}(r; k, p)$.

Let $(x, y) = (x_1, \dots, x_r, y_1, \dots, y_k)$ be a fixed coordinate system of $(\mathbb{H}^r \times \mathbb{R}^k, 0)$. We denote by $\mathcal{B}(r; k)$ the group of diffeomorphism germs $(\mathbb{H}^r \times \mathbb{R}^k, 0) \rightarrow (\mathbb{H}^r \times \mathbb{R}^k, 0)$ of the form:

$$\phi(x, y) = (x_1 \phi_1^1(x, y), \dots, x_r \phi_1^r(x, y), \phi_2^1(x, y), \dots, \phi_2^k(x, y)).$$

We denote by $\mathcal{B}_n(r; k+n)$ the group of diffeomorphism germs $(\mathbb{H}^r \times \mathbb{R}^{k+n}, 0) \rightarrow (\mathbb{H}^r \times \mathbb{R}^{k+n}, 0)$ of the form:

$$\phi(x, y, u) = (x_1 \phi_1^1(x, y, u), \dots, x_r \phi_1^r(x, y, u), \phi_2^1(x, y, u), \dots, \phi_2^k(x, y, u), \phi_3^1(u), \dots, \phi_3^n(u)).$$

We denote $\phi(x, y, u) = (x \phi_1(x, y, u), \phi_2(x, y, u), \phi_3(u))$, $\frac{\partial f_0}{\partial y} = (\frac{\partial f_0}{\partial y_1}, \dots, \frac{\partial f_0}{\partial y_k})$, and denote other notations analogously.

Lemma 2.1 (cf., [6, Corollary 1.8]), also see [3, Lemma2.1]) *Let B be a submodule of $\mathcal{E}(r; k+n+m)$, A_1 be a finitely generated $\mathcal{E}(m)$ -submodule of $\mathcal{E}(r; k+n+m)$ generated d -elements, and A_2 be a finitely generated $\mathcal{E}(n+m)$ submodule of $\mathcal{E}(r; k+n+m)$. Suppose*

$$\mathcal{E}(r; k+n+m) = B + A_2 + A_1 + \mathfrak{M}(m)\mathcal{E}(r; k+n+m) + \mathfrak{M}(n+m)^{d+1}\mathcal{E}(r; k+n+m).$$

Then

$$\begin{aligned} \mathcal{E}(r; k+n+m) &= B + A_2 + A_1, \\ \mathfrak{M}(n+m)^d \mathcal{E}(r; k+n+m) &\subset B + A_2 + \mathfrak{M}(m)\mathcal{E}(r; k+n+m). \end{aligned}$$

We recall the stabilities of n -dimensional unfolding under *reticular \mathcal{P} - \mathcal{K} -equivalence* which is developed in [2].

We say that $f_0, g_0 \in \mathcal{E}(r; k)$ are *reticular \mathcal{K} -equivalent* if there exist $\phi \in \mathcal{B}(r; k)$ and a unit $a \in \mathcal{E}(r; k)$ such that $g_0 = a \cdot f_0 \circ \phi$.

We say that a function germ $f_0 \in \mathfrak{M}(r; k)$ is *reticular \mathcal{K} - l -determined* if all function germ which has same l -jet of f_0 is reticular \mathcal{K} -equivalent to f_0 . If f_0 is reticular \mathcal{K} - l -determined for some l , then we say that f_0 is *reticular \mathcal{K} -finitely determined*.

Lemma 2.2 (see [3, Lemma 2.3]) *Let $f_0(x, y) \in \mathfrak{M}(r; k)$ and let*

$$\mathfrak{M}(r; k)^{l+1} \subset \mathfrak{M}(r; k) \langle \langle f_0, x \frac{\partial f_0}{\partial x} \rangle + \mathfrak{M}(r; k) \langle \frac{\partial f_0}{\partial y} \rangle \rangle + \mathfrak{M}(r; k)^{l+2},$$

then f_0 is *reticular \mathcal{K} - l -determined*. Conversely if $f_0(x, y) \in \mathfrak{M}(r; k)$ is *reticular \mathcal{K} - l -determined*, then

$$\mathfrak{M}(r; k)^{l+1} \subset \langle f_0, x \frac{\partial f_0}{\partial x} \rangle_{\mathcal{E}(r; k)} + \mathfrak{M}(r; k) \langle \frac{\partial f_0}{\partial y} \rangle.$$

We say that $f, g \in \mathcal{E}(r; k+n)$ are *reticular \mathcal{P} - \mathcal{K} -equivalent* if there exist $\Phi \in \mathcal{B}_n(r; k+n)$ and a unit $\alpha \in \mathcal{E}(r; k+n)$ such that $g = \alpha \cdot f \circ \Phi$.

We say that $f(x, y, u) \in \mathfrak{M}(r; k+n)$ is *reticular \mathcal{P} - \mathcal{K} -infinitesimally stable* if

$$\mathcal{E}(r; k+n) = \langle f, x \frac{\partial f}{\partial x}, \frac{\partial f}{\partial y} \rangle_{\mathcal{E}(r; k+n)} + \langle \frac{\partial f}{\partial u} \rangle_{\mathcal{E}(n)}.$$

We define the several stabilities of unfolding of function germ under the reticular \mathcal{P} - \mathcal{K} -equivalence in $\mathfrak{M}(r; k)$ in [3]. We have the following theorem:

Theorem 2.3 (see [3, Theorem 2.5]) *Let $f \in \mathfrak{M}(r; k+n)$ be an unfolding of $f_0 \in \mathfrak{M}(r; k)$. Then the following are equivalent.*

- (1) f is reticular \mathcal{P} - \mathcal{K} -stable.
- (2) f is reticular \mathcal{P} - \mathcal{K} -versal.
- (3) f is reticular \mathcal{P} - \mathcal{K} -infinitesimally versal.
- (4) f is reticular \mathcal{P} - \mathcal{K} -infinitesimally stable.
- (5) f is reticular \mathcal{P} - \mathcal{K} -homotopically stable.

We say that $F, G \in \mathcal{E}(r; k+n+m)$ are *reticular t - \mathcal{P} - \mathcal{K} -equivalent* if there exist $\Phi \in \mathcal{B}(r; k+n+m)$ and a unit $\alpha \in \mathcal{E}(r; k+n+m)$ such that

- (1) Φ can be written in the form: $\Phi(x, y, u, t) = (x\phi_1(x, y, u, t), \phi_2(x, y, u, t), \phi_3(u, t), \phi_4(t))$,
- (2) $G = \alpha \cdot F \circ \Phi$.

We say that $F(x, y, u, t) \in \mathfrak{M}(r; k+n+m)$ is *reticular t - \mathcal{P} - \mathcal{K} -infinitesimally stable* if

$$\mathcal{E}(r; k+n+m) = \langle F, x \frac{\partial F}{\partial x}, \frac{\partial F}{\partial y} \rangle_{\mathcal{E}(r; k+n+m)} + \langle \frac{\partial F}{\partial u} \rangle_{\mathcal{E}(n+m)} + \langle \frac{\partial F}{\partial t} \rangle_{\mathcal{E}(m)}. \quad (1)$$

We define the several stabilities of unfolding of function germ under the reticular t - \mathcal{P} - \mathcal{K} -equivalence in $\mathfrak{M}(r; k+n+m)$ in [3]. We have the following theorem:

Theorem 2.4 (see [3, Theorem 3.14]) *Let $F(x, y, u, t) \in \mathfrak{M}(r; k+n+m)$ be an unfolding of $f(x, y, u) \in \mathfrak{M}(r; k+n)$ and let f is an unfolding of $f_0(x, y) \in \mathfrak{M}(r; k)$. Then following are equivalent.*

- (1) *There exists a non-negative number l such that f_0 is reticular \mathcal{K} - l -determined and F is reticular t - \mathcal{P} - \mathcal{K} - q -transversal for $q \geq lm + l + m + 1$.*
- (2) F is reticular t - \mathcal{P} - \mathcal{K} -stable.
- (3) F is reticular t - \mathcal{P} - \mathcal{K} -versal.
- (4) F is reticular t - \mathcal{P} - \mathcal{K} -infinitesimally versal.
- (5) F is reticular t - \mathcal{P} - \mathcal{K} -infinitesimally stable.
- (6) F is reticular t - \mathcal{P} - \mathcal{K} -homotopically stable.

This theorem is used in the proof of Theorem 4.4.

3 Reticular Legendrian unfoldings

We consider the 1-jet bundle $J^1(\mathbb{R}^n, \mathbb{R})$ with the canonical 1-form θ and the canonical coordinate system $(q, z, p) = (q_1, \dots, q_n, z, p_1, \dots, p_n)$, the natural projection $\pi : J^1(\mathbb{R}^n, \mathbb{R}) \rightarrow$

$\mathbb{R}^n \times \mathbb{R}((q, z, p) \mapsto (q, z))$. We also consider the big 1-jet bundle $J^1(\mathbb{R}^m \times \mathbb{R}^n, \mathbb{R})$. and the canonical 1-form Θ on that space. Let $(t, q) = (t_1, \dots, t_m, q_1, \dots, q_n)$ be the canonical coordinate system on $\mathbb{R}^m \times \mathbb{R}^n$ and $(t, q, z, s, p) = (t_1, \dots, t_m, q_1, \dots, q_n, z, s_1, \dots, s_m, p_1, \dots, p_n)$ be the corresponding coordinate system on $J^1(\mathbb{R}^m \times \mathbb{R}^n, \mathbb{R})$. Then the canonical 1-form Θ is given by

$$\Theta = dz - \sum_{i=1}^n p_i dq_i - \sum_{i=1}^m s_i dt_i.$$

There exists the natural projection

$$\Pi : J^1(\mathbb{R}^m \times \mathbb{R}^n, \mathbb{R}) \rightarrow \mathbb{R}^m \times \mathbb{R}^n \times \mathbb{R} \quad (t, q, z, s, p) \mapsto (t, q, z).$$

Then we consider the following contact diffeomorphism germ C on $(J^1(\mathbb{R}^m \times \mathbb{R}^n, \mathbb{R}), 0)$:

Lemma 3.1 (cf., [5, Lemma 3.1]) *For any multi-family of contact embedding germs $C_t : (J^1(\mathbb{R}^n, \mathbb{R}), 0) \rightarrow J^1(\mathbb{R}^n, \mathbb{R})$ ($C_0(0) = 0$) depending smoothly on $t \in (\mathbb{R}^m, 0)$, there exist unique function germs h_1, \dots, h_m on $(J^1(\mathbb{R}^m \times \mathbb{R}^n, \mathbb{R}), 0)$ such that h_i depends only on t, q, z, s_i, p for each i and the map germ $C : (J^1(\mathbb{R}^m \times \mathbb{R}^n, \mathbb{R}), 0) \rightarrow (J^1(\mathbb{R}^m \times \mathbb{R}^n, \mathbb{R}), 0)$ defined by*

$$C(t, q, z, s, p) = (t, q \circ C_t(q, z, p), z \circ C_t(q, z, p), h(t, q, z, s, p), p \circ C_t(q, z, p))$$

is a contact diffeomorphism.

The function germ h_i is uniquely determined by

$$h_i(t, q, z, s, p) = \frac{\partial z_t}{\partial t}(q, z, p) - p_t(q, z, p) \frac{\partial q_t}{\partial t}(q, z, p) + \alpha(t, q, z, p) s_i. \quad (2)$$

We define that $\tilde{L}_\sigma^0 = \{(t, q, z, s, p) \in J^1(\mathbb{R}^m \times \mathbb{R}^n, \mathbb{R}) | q_\sigma = p_{I_r - \sigma} = q_{r+1} = \dots = q_n = s = z = 0, q_{I_r - \sigma} \geq 0\}$ for $\sigma \subset I_r$ and $\mathbb{L} = \{(t, q, z, s, p) \in J^1(\mathbb{R}^m \times \mathbb{R}^n, \mathbb{R}) | q_1 p_1 = \dots = q_r p_r = q_{r+1} = \dots = q_n = s = z = 0, q_{I_r} \geq 0\}$ be a representative as a germ of the union of \tilde{L}_σ^0 for all $\sigma \subset I_r$.

Definition 3.2 Let C be a contact diffeomorphism germ on $(J^1(\mathbb{R}^m \times \mathbb{R}^n, \mathbb{R}), 0)$. We say that C is a \mathcal{P} -contact diffeomorphism if C has the form:

$$C(t, q, z, s, p) = (t, q_C(t, q, z, p), z_C(t, q, z, p), h_C(t, q, z, s, p), p_C(t, q, z, p)) \quad (3)$$

and the function germ h_C^i depends only on t, q, z, s_i, p for each $i = 1, \dots, m$.

Definition 3.3 We say that a map germ $\mathcal{L} : (\mathbb{L}, 0) \rightarrow (J^1(\mathbb{R}^m \times \mathbb{R}^n, \mathbb{R}), 0)$ is a *reticular Legendrian unfolding* if \mathcal{L} is the restriction of a \mathcal{P} -contact diffeomorphism. We call $\{\mathcal{L}(\tilde{L}_\sigma^0)\}_{\sigma \subset I_r}$ the *unfolded contact regular r -cubic configuration* of \mathcal{L} .

We note that: Let $\{\tilde{L}_\sigma\}_{\sigma \subset I_r}$ be an unfolded contact regular r -cubic configuration associated with an m -parameter family of contact regular r -cubic configurations $\{L_{\sigma,t}\}_{\sigma \subset I_r, t \in (\mathbb{R}^m, 0)}$. Then there is the following relation between the wavefront $W_\sigma = \Pi(\tilde{L}_\sigma)$ and the family of wavefronts $W_{\sigma,t} = \pi(L_{\sigma,t})$:

$$W_\sigma = \bigcup_{t \in (\mathbb{R}^m, 0)} \{t\} \times W_{\sigma,t} \quad \text{for all } \sigma \subset I_r.$$

Let K, Ψ be contact diffeomorphism germs on $(J^1(\mathbb{R}^m \times \mathbb{R}^n, \mathbb{R}), 0)$. We say that K is a \mathcal{P} -Legendrian equivalence if K has the form:

$$K(t, q, z, s, p) = (\phi_1(t), \phi_2(t, q, z), \phi_3(t, q, z), \phi_4(t, q, z, s, p), \phi_5(t, q, z, s, p)). \quad (4)$$

We say that Ψ is a *reticular \mathcal{P} -diffeomorphism* if $\pi_t \circ \Psi$ depends only on t and Ψ preserves \tilde{L}_σ^0 for all $\sigma \subset I_r$.

Let $\{\tilde{L}_\sigma^i\}_{\sigma \subset I_r}$ ($i = 1, 2$) be unfolded contact regular r -cubic configurations on $(J^1(\mathbb{R}^m \times \mathbb{R}^n, \mathbb{R}), 0)$. We say that they are \mathcal{P} -Legendrian equivalent if there exist a \mathcal{P} -Legendrian equivalence K such that $\tilde{L}_\sigma^2 = K(\tilde{L}_\sigma^1)$ for all $\sigma \subset I_r$.

In order to understand the meaning of \mathcal{P} -Legendrian equivalence, we observe the following: Let $\{\tilde{L}_\sigma^i\}_{\sigma \subset I_r}$ ($i = 1, 2$) be unfolded contact regular r -cubic configurations on $(J^1(\mathbb{R}^m \times \mathbb{R}^n, \mathbb{R}), 0)$ and $\{L_{\sigma,t}^i\}_{\sigma \subset I_r, t \in (\mathbb{R}^m, 0)}$ be the corresponding m -parameter families of contact regular r -cubic configurations on $J^1(\mathbb{R}^n, \mathbb{R})$ respectively. We take the smooth m -parameter path germs $w_i : (\mathbb{R}^m, 0) \rightarrow (J^1(\mathbb{R}^n, \mathbb{R}), 0)$ such that $\{L_{\sigma,t}^i\}_{\sigma \subset I_r}$ are defined at $w_i(t)$ for $i = 1, 2$. Suppose that there exists a \mathcal{P} -Legendrian equivalence K from $\{\tilde{L}_\sigma^1\}_{\sigma \subset I_r}$ to $\{\tilde{L}_\sigma^2\}_{\sigma \subset I_r}$ of the form (4). We set $W_{\sigma,t}^i$ be the wavefront of $L_{\sigma,t}^i$ for $\sigma \subset I_r$, $t \in (\mathbb{R}^m, 0)$ and $i = 1, 2$. We define the family of diffeomorphism $g_t : (\mathbb{R}^n \times \mathbb{R}, \pi(w_1(t))) \rightarrow (\mathbb{R}^n \times \mathbb{R}, \pi(w_2(t)))$ by $g_t(q, z) = (\phi_2(t, q, z), \phi_3(t, q, z))$. Then we have that $g_t(W_{\sigma,t}^1) = W_{\sigma, \phi_1(t)}^2$ for all $\sigma \subset I_r$, $t \in (\mathbb{R}^m, 0)$.

We also define the equivalence relation among reticular Legendrian unfoldings. Let $\mathcal{L}_i : (\mathbb{L}, 0) \rightarrow (J^1(\mathbb{R}^m \times \mathbb{R}^n, \mathbb{R}), 0)$, ($i = 1, 2$) be reticular Legendrian unfoldings. We say that \mathcal{L}_1 and \mathcal{L}_2 are \mathcal{P} -Legendrian equivalent if there exist a \mathcal{P} -Legendrian equivalence K and a reticular \mathcal{P} -diffeomorphism Ψ such that $K \circ \mathcal{L}_1 = \mathcal{L}_2 \circ \Psi$.

Lemma 3.4 (cf., [5, Lemma 3.4]) *Let $\{\tilde{L}_\sigma\}_{\sigma \subset I_r}$ be an unfolded contact regular r -cubic configuration on $(J^1(\mathbb{R}^m \times \mathbb{R}^n, \mathbb{R}), 0)$. Then there exists a \mathcal{P} -contact diffeomorphism germ C on $(J^1(\mathbb{R}^m \times \mathbb{R}^n, \mathbb{R}), 0)$ such that C defines $\{\tilde{L}_\sigma\}_{\sigma \subset I_r}$ and preserves the canonical 1-form.*

We can construct generating families of reticular Legendrian unfoldings. A function germ $F(x, y, t, q, z) \in \mathfrak{M}(r; k + m + n + 1)$ is said to be \mathcal{P} - C -non-degenerate if $\frac{\partial F}{\partial x}(0) = \frac{\partial F}{\partial y}(0) = 0$ and $x, t, F, \frac{\partial F}{\partial x}, \frac{\partial F}{\partial y}$ are independent on $(\mathbb{H}^k \times \mathbb{R}^{k+m+n+1}, 0)$.

A \mathcal{P} - C -non-degenerate function germ $F(x, y, t, q, z) \in \mathfrak{M}(r; k + m + n + 1)$ is called a *generating family* of a reticular Legendrian unfoldings \mathcal{L} if

$$\begin{aligned} \mathcal{L}(\tilde{L}_\sigma^0) &= \{(t, q, z, \frac{\partial F}{\partial t} / (-\frac{\partial F}{\partial z}), \frac{\partial F}{\partial q} / (-\frac{\partial F}{\partial z})) \in (J^1(\mathbb{R}^m \times \mathbb{R}^n, \mathbb{R}), 0) | \\ & x_\sigma = F = \frac{\partial F}{\partial x_{I_r - \sigma}} = \frac{\partial F}{\partial y} = 0, x_{I_r - \sigma} \geq 0\} \text{ for all } \sigma \subset I_r. \end{aligned}$$

By Lemma 3.4 we may assume that an extension of reticular Legendrian unfolding preserves the canonical 1-form.

Lemma 3.5 (cf., [5, Lemma 3.5]) *Let C be a \mathcal{P} -contact diffeomorphism germ $(J^1(\mathbb{R}^m \times \mathbb{R}^n, \mathbb{R}), 0) \rightarrow (J^1(\mathbb{R}^m \times \mathbb{R}^n, \mathbb{R}), 0)$ which preserves the canonical 1-form. If the map germ*

$$(T, Q, Z, S, P) \rightarrow (T, Q, Z, s_C(T, Q, Z, S, P), p_C(T, Q, Z, S, P))$$

is a diffeomorphism, there exists a function germ $H(T, Q, p) \in \mathfrak{M}(m+n+n)^2$ such that the canonical relation P_C associated with C has the form:

$$P_C = \left\{ (T, Q, Z, -\frac{\partial H}{\partial T}(T, Q, p) + s, -\frac{\partial H}{\partial Q}, T, -\frac{\partial H}{\partial p}, H - \langle \frac{\partial H}{\partial p}, p \rangle + Z, s, p) \right\}, \quad (5)$$

and the function germ $F \in \mathfrak{M}(r; n+m+n+1)$ defined by $F(x, y, t, q, z) = -z + H(t, x, 0, y) + \langle y, q \rangle$ is a generating family of the reticular Legendrian unfolding $C|_{\mathbb{L}}$.

We have the following theorem which gives the relations between reticular Legendrian unfoldings and their generating families.

Theorem 3.6 (cf., [5, Theorem 3.6]) (1) *For any reticular Legendrian unfolding $\mathcal{L} : (\mathbb{L}, 0) \rightarrow (J^1(\mathbb{R}^m \times \mathbb{R}^n, \mathbb{R}), 0)$, there exists a function germ $F(x, y, t, q, z) \in \mathfrak{M}(r; k+m+n+1)$ which is a generating family of \mathcal{L} .*

(2) *For any \mathcal{P} - C -non-degenerate function germ $F(x, y, t, q, z) \in \mathfrak{M}(r; k+m+n+1)$ with $\frac{\partial F}{\partial t}(0) = \frac{\partial F}{\partial q}(0) = 0$, there exists a reticular Legendrian unfolding $\mathcal{L} : (\mathbb{L}, 0) \rightarrow (J^1(\mathbb{R}^m \times \mathbb{R}^n, \mathbb{R}), 0)$ of which F is a generating family.*

(3) *Two reticular Legendrian unfolding are \mathcal{P} -Legendrian equivalent if and only if their generating families are stably reticular t - \mathcal{P} - \mathcal{K} -equivalent.*

4 Stabilities of reticular Legendrian unfoldings

Let U be an open set in $J^1(\mathbb{R}^m \times \mathbb{R}^n, \mathbb{R})$. We consider contact embedding germs $(J^1(\mathbb{R}^m \times \mathbb{R}^n, \mathbb{R}), 0) \rightarrow J^1(\mathbb{R}^m \times \mathbb{R}^n, \mathbb{R})$ and contact embeddings $U \rightarrow J^1(\mathbb{R}^m \times \mathbb{R}^n, \mathbb{R})$. Let (T, Q, S, Z, P) and (t, q, z, s, p) be canonical coordinates of the source space and the target space respectively. We define the following notations:

$\iota : (J^1(\mathbb{R}^m \times \mathbb{R}^n, \mathbb{R}) \cap \{Z = 0\}, 0) \rightarrow (J^1(\mathbb{R}^m \times \mathbb{R}^n, \mathbb{R}), 0)$ be the inclusion map on the source space,

$$\begin{aligned} C_T(J^1(\mathbb{R}^m \times \mathbb{R}^n, \mathbb{R}), 0) &= \{C \mid C \text{ is a } \mathcal{P}\text{-contact embedding germ} \\ &\quad (J^1(\mathbb{R}^m \times \mathbb{R}^n, \mathbb{R}), 0) \rightarrow J^1(\mathbb{R}^m \times \mathbb{R}^n, \mathbb{R})\}, \\ C_T^\Theta(J^1(\mathbb{R}^m \times \mathbb{R}^n, \mathbb{R}), 0) &= \{C \in C_T(J^1(\mathbb{R}^m \times \mathbb{R}^n, \mathbb{R}), 0) \mid C^*\Theta = \Theta\}, \\ C_T^Z(J^1(\mathbb{R}^m \times \mathbb{R}^n, \mathbb{R}), 0) &= \{C \circ \iota \mid C \in C_T(J^1(\mathbb{R}^m \times \mathbb{R}^n, \mathbb{R}), 0)\}, \\ C_T^{\Theta, Z}(J^1(\mathbb{R}^m \times \mathbb{R}^n, \mathbb{R}), 0) &= \{C \circ \iota \mid C \in C_T^\Theta(J^1(\mathbb{R}^m \times \mathbb{R}^n, \mathbb{R}), 0)\}. \end{aligned}$$

Let $V = U \cap \{Z = 0\}$ and $\tilde{\iota} : V \rightarrow U$ be the inclusion map.

$$\begin{aligned} C_T(U, J^1(\mathbb{R}^m \times \mathbb{R}^n, \mathbb{R})) &= \{\tilde{C} : U \rightarrow J^1(\mathbb{R}^m \times \mathbb{R}^n, \mathbb{R}) \mid \\ &\quad \tilde{C} \text{ is a contact embedding of the form (3)}\}, \\ C_T^\Theta(U, J^1(\mathbb{R}^m \times \mathbb{R}^n, \mathbb{R})) &= \{\tilde{C} \in C_T(U, J^1(\mathbb{R}^m \times \mathbb{R}^n, \mathbb{R})) \mid \tilde{C}^*\Theta = \Theta\}, \\ C_T^Z(V, J^1(\mathbb{R}^m \times \mathbb{R}^n, \mathbb{R})) &= \{\tilde{C} \circ \tilde{\iota} \mid \tilde{C} \in C_T(U, J^1(\mathbb{R}^m \times \mathbb{R}^n, \mathbb{R}))\}, \\ C_T^{\Theta, Z}(V, J^1(\mathbb{R}^m \times \mathbb{R}^n, \mathbb{R})) &= \{\tilde{C} \circ \tilde{\iota} \mid \tilde{C} \in C_T^\Theta(U, J^1(\mathbb{R}^m \times \mathbb{R}^n, \mathbb{R}))\}. \end{aligned}$$

Definition 4.1 We define stabilities of reticular Legendrian unfoldings. Let \mathcal{L} be a reticular Legendrian unfolding.

Stability: We say that \mathcal{L} is *stable* if the following condition holds: Let $C^0 \in C_T(J^1(\mathbb{R}^m \times \mathbb{R}^n, \mathbb{R}), 0)$ be \mathcal{P} -contact embedding germs such that $C^0|_{\mathbb{L}} = \mathcal{L}$ and $\tilde{C}^0 \in C_T(U, J^1(\mathbb{R}^m \times \mathbb{R}^n, \mathbb{R}))$ be representatives of C^0 . Then there exist open neighborhoods $N_{\tilde{C}^0}$ of \tilde{C}^0 in C^∞ -topology such that for any $\tilde{C} \in N_{\tilde{C}^0}$, there exist points $x_0 = (T, 0, \dots, 0, P_{r+1}^0, \dots, P_n^0) \in U$ such that the reticular Legendrian unfolding \mathcal{L}_{x_0} and \mathcal{L} are $\mathcal{P}_{(m)}$ -Legendrian equivalent, where the reticular Legendrian unfolding \mathcal{L}_{x_0} is defined by

$$x = (T, Q, Z, S, P) \mapsto \tilde{C}(x_0 + x) - \tilde{C}(x_0) + (0, 0, P_{r+1}^0 Q_{r+1} + \dots + P_n^0 Q_n, 0, 0).$$

Homotopical stability: A one-parameter family of \mathcal{P} -contact embedding germs $\bar{C} : (J^1(\mathbb{R}^m \times \mathbb{R}^n, \mathbb{R}) \times \mathbb{R}, (0, 0)) \rightarrow J^1(\mathbb{R}^m \times \mathbb{R}^n, \mathbb{R})$ $((T, Q, Z, S, P, \tau) \mapsto C_\tau(T, Q, Z, S, P))$ is called a \mathcal{P} -contact deformation of \mathcal{L} if $C_0|_{\mathbb{L}} = \mathcal{L}$. A map germ $\bar{\Psi} : (J^1(\mathbb{R}^m \times \mathbb{R}^n, \mathbb{R}) \times \mathbb{R}, (0, 0)) \rightarrow (J^1(\mathbb{R}^m \times \mathbb{R}^n, \mathbb{R}), 0)$ $((T, Q, Z, S, P, \tau) \mapsto \Psi_\tau(T, Q, Z, S, P))$ is called a *one-parameter deformation of reticular diffeomorphisms* if $\Psi_0 = id_{J^1(\mathbb{R}^m \times \mathbb{R}^n, \mathbb{R})}$ and Ψ_t is a \mathcal{P} -diffeomorphism for all t around 0. We say that \mathcal{L} is *homotopically stable* if for any reticular \mathcal{P} -contact deformations $\bar{C} = \{C_\tau\}$ of \mathcal{L} , there exist one-parameter families of \mathcal{P} -Legendrian equivalences $\bar{K} = \{K_\tau\}$ on $(J^1(\mathbb{R}^m \times \mathbb{R}^n, \mathbb{R}), 0)$ with $K_0 = id$ of the form

$$K_\tau(t, q, z, s, p) = (\phi_\tau^1(t), \phi_\tau^2(t, q, z), \phi_\tau^3(t, q, z), \phi_\tau^4(t, q, z, s, p), \phi_\tau^5(t, q, z, s, p)) \quad (6)$$

and one-parameter deformations of reticular \mathcal{P} -diffeomorphisms $\bar{\Psi} = \{\Psi_\tau\}$ such that $C_\tau = K_\tau \circ C_0 \circ \Psi_\tau$ for t around 0.

Infinitesimal stability: Let $C \in C_T(J^1(\mathbb{R}^m \times \mathbb{R}^n, \mathbb{R}), 0)$ be a \mathcal{P} -contact diffeomorphism germ. We say that a vector field v on $(J^1(\mathbb{R}^m \times \mathbb{R}^n, \mathbb{R}), 0)$ along C is an *infinitesimal \mathcal{P} -contact transformation* of C if there exists a \mathcal{P} -contact deformation $\bar{C} = \{C_\tau\}$ on $(J^1(\mathbb{R}^m \times \mathbb{R}^n, \mathbb{R}), 0)$ such that $C_0 = C$ and $\frac{dC_\tau}{d\tau}|_{\tau=0} = v$. We say that a vector field ξ on $(J^1(\mathbb{R}^m \times \mathbb{R}^n, \mathbb{R}), 0)$ is an *infinitesimal reticular \mathcal{P} -diffeomorphism* if there exists a one-parameter deformation of reticular \mathcal{P} -diffeomorphisms $\bar{\Psi} = \{\Psi_\tau\}$ such that $\frac{d\Psi_\tau}{d\tau}|_{\tau=0} = \xi$. We say that a vector field η on $(J^1(\mathbb{R}^m \times \mathbb{R}^n, \mathbb{R}), w)$ is an *infinitesimal \mathcal{P} -Legendrian equivalence* if there exists a one-parameter family of \mathcal{P} -Legendrian equivalences $\bar{K} = \{K_\tau\}$ such that $K_0 = id_{J^1(\mathbb{R}^m \times \mathbb{R}^n, \mathbb{R})}$ and $\frac{dK_\tau}{d\tau}|_{\tau=0} = \eta$. We say that \mathcal{L} is *infinitesimally stable* if for any extension C of \mathcal{L} and any infinitesimal \mathcal{P} -contact transformation v of C , there exist infinitesimal reticular \mathcal{P} -diffeomorphisms ξ and infinitesimal \mathcal{P} -Legendrian equivalences η of the form

$$\begin{aligned} \eta(t, q, z, s, p) = & a_1(t) \frac{\partial}{\partial t} + a_2(t, q, z) \frac{\partial}{\partial q} + a_3(t, q, z) \frac{\partial}{\partial z} \\ & + a_4(t, q, z, s, p) \frac{\partial}{\partial s} + a_5(t, q, z, s, p) \frac{\partial}{\partial p} \end{aligned} \quad (7)$$

such that $v = C_* \xi + \eta \circ C$.

We may take an extension of a reticular Legendrian unfolding \mathcal{L} by an element of $C_T^\Theta(J^1(\mathbb{R}^m \times \mathbb{R}^n, \mathbb{R}), 0)$ by Lemma 3.4. Then as the remark after the definition of the stability of reticular Legendrian maps in [2, p.121], we may consider the following other definitions of stabilities of multi-reticular Legendrian unfoldings: (1) The definition given by replacing $C_T(J^1(\mathbb{R}^m \times \mathbb{R}^n, \mathbb{R}), 0)$ and $C_T(U, J^1(\mathbb{R}^m \times \mathbb{R}^n, \mathbb{R}))$ to $C_T^\Theta(J^1(\mathbb{R}^m \times \mathbb{R}^n, \mathbb{R}), 0)$ and $C_T^\Theta(U, J^1(\mathbb{R}^m \times \mathbb{R}^n, \mathbb{R}))$ of original definition respectively. (2) The definition given by replacing to $C_T^Z(J^1(\mathbb{R}^m \times \mathbb{R}^n, \mathbb{R}), 0)$ and $C_T^Z(V, J^1(\mathbb{R}^m \times \mathbb{R}^n, \mathbb{R}))$ respectively. (3) The definition

given by replacing to $C_T^{\Theta, Z}(J^1(\mathbb{R}^m \times \mathbb{R}^n, \mathbb{R}), 0)$ and $C_T^{\Theta, Z}(V, J^1(\mathbb{R}^m \times \mathbb{R}^n, \mathbb{R}))$ respectively, where $V = U \cap \{Z = 0\}$.

Then we have the following lemma which is proved by the same method of the proof of [2, Lemma 7.2]

Lemma 4.2 (cf., [5, Lemma 4.3]) *The original definition and other three definitions of stabilities of reticular Legendrian unfoldings are all equivalent.*

By this lemma, we may choose an extension of a reticular Legendrian unfolding from among all of $C_T(J^1(\mathbb{R}^m \times \mathbb{R}^n, \mathbb{R}), 0)$, $C_T^{\Theta}(J^1(\mathbb{R}^m \times \mathbb{R}^n, \mathbb{R}), 0)$, $C_T^Z(J^1(\mathbb{R}^m \times \mathbb{R}^n, \mathbb{R}), 0)$, and $C_T^{\Theta, Z}(J^1(\mathbb{R}^m \times \mathbb{R}^n, \mathbb{R}), 0)$.

We say that a function germ H on $(J^1(\mathbb{R}^m \times \mathbb{R}^n, \mathbb{R}), 0)$ is \mathcal{P} -fiber preserving if H has the form $H(t, q, z, s, p) = \sum_{i=1}^n h_j(t, q, z)p_j + h_0(t, q, z) + \sum_{i=1}^m a_i(t)s_i$.

Lemma 4.3 (cf., [5, Lemma 4.4]) *Let $C \in C_T(J^1(\mathbb{R}^m \times \mathbb{R}^n, \mathbb{R}), 0)$. Then the following hold: (1) A vector field germ v on $(J^1(\mathbb{R}^m \times \mathbb{R}^n, \mathbb{R}), 0)$ along C is an infinitesimal \mathcal{P} -contact transformation of C if and only if there exists a function germ f on $(J^1(\mathbb{R}^m \times \mathbb{R}^n, \mathbb{R}), 0)$ such that f does not depend on s and $v = X_f \circ C$.*

(2) *A vector field germ η on $(J^1(\mathbb{R}^m \times \mathbb{R}^n, \mathbb{R}), 0)$ is an infinitesimal \mathcal{P} -Legendrian equivalence if and only if there exists a \mathcal{P} -fiber preserving function germ H on $(J^1(\mathbb{R}^m \times \mathbb{R}^n, \mathbb{R}), 0)$ such that $\eta = X_H$.*

(3) *A vector field ξ on $(J^1(\mathbb{R}^m \times \mathbb{R}^n, \mathbb{R}), 0)$ is an infinitesimal reticular \mathcal{P} -diffeomorphism if and only if there exists a function germ $g \in B$ such that $\xi = X_g$, where $B = \langle q_1 p_1, \dots, q_r p_r, q_{r+1}, \dots, q_n, z \rangle_{\mathcal{E}_{t,q,z,p}} + \langle s \rangle_{\mathcal{E}_t}$.*

We define the several stabilities of reticular Legendrian unfoldings and we have the following theorem:

Theorem 4.4 (cf., [5, Theorem 4.6]) *Let \mathcal{L} be a reticular Legendrian unfolding with a generating family $F(x, y, t, q, z)$. Then the following are all equivalent.*

(u) *F is a reticular t - \mathcal{P} - \mathcal{K} -stable unfolding of $F|_{t=0}$.*

(hs) *\mathcal{L} is homotopically stable.*

(is) *\mathcal{L} is infinitesimally stable.*

(a) *$\mathcal{E}_{t,q,p} = B_0 + \langle 1, p_1 \circ C', \dots, p_n \circ C' \rangle_{(\Pi \circ C')^* \mathcal{E}_{t,q,z}} + \langle s \circ C' \rangle_{\mathcal{E}_t}$, where $C' = C|_{z=s=0}$ and $B_0 = \langle q_1 p_1, \dots, q_r p_r, q_{r+1}, \dots, q_n \rangle_{\mathcal{E}_{t,q,p}}$.*

5 Genericity of reticular Legendrian unfoldings

In order to give a generic classification of reticular Legendrian unfoldings, we reduce our investigation to finite dimensional jet spaces of \mathcal{P} -contact diffeomorphism germs.

Definition 5.1 Let \mathcal{L} be a reticular Legendrian unfolding. We say that \mathcal{L} is l -determined if the following condition holds: For any extension $C \in C_T(J^1(\mathbb{R}^m \times \mathbb{R}^n, \mathbb{R}), 0)$ of \mathcal{L} , the reticular Legendrian unfolding $C'|_{\mathbb{L}}$ and \mathcal{L} are \mathcal{P} -Legendrian equivalent for all $C' \in C_T(J^1(\mathbb{R}^m \times \mathbb{R}^n, \mathbb{R}), 0)$ satisfying that $j^l C(0) = j^l C'(0)$.

As Lemma 4.2, we may consider the following other definition of finitely determinacy of reticular Legendrian maps:

- (1) The definition given by replacing $C_T(J^1(\mathbb{R}^m \times \mathbb{R}^n, \mathbb{R}), 0)$ to $C_T^\Theta(J^1(\mathbb{R}^m \times \mathbb{R}^n, \mathbb{R}), 0)$.
 - (2) The definition given by replacing $C_T(J^1(\mathbb{R}^m \times \mathbb{R}^n, \mathbb{R}), 0)$ to $C_T^Z(J^1(\mathbb{R}^m \times \mathbb{R}^n, \mathbb{R}), 0)$.
 - (3) The definition given by replacing $C_T(J^1(\mathbb{R}^m \times \mathbb{R}^n, \mathbb{R}), 0)$ to $C_T^{\Theta, Z}(J^1(\mathbb{R}^m \times \mathbb{R}^n, \mathbb{R}), 0)$.
- Then the following holds by [4, p.341 Proposition 5.6]:

Proposition 5.2 (cf., [5, Proposition 5.2]) *Let \mathcal{L} be a reticular Legendrian unfolding. Then*

- (A) *If \mathcal{L} is l -determined of the original definition, then \mathcal{L} is l -determined of the definition (1).*
- (B) *If \mathcal{L} is l -determined of the definition (1), then \mathcal{L} is l -determined of the definition (3).*
- (C) *If \mathcal{L} is $(l + 1)$ -determined of the definition (3), then \mathcal{L} is l -determined of the definition (2).*
- (D) *If \mathcal{L} is l -determined of the definition (2), then \mathcal{L} is l -determined of the original definition.*

Theorem 5.3 (cf., [5, Lemma 5.3]) *Let $\mathcal{L} : (\mathbb{L}, 0) \rightarrow (J^1(\mathbb{R}^m \times \mathbb{R}^n, \mathbb{R}), 0)$ be a reticular Legendrian unfolding. If \mathcal{L} is infinitesimally stable then \mathcal{L} is $(n + m + 3)$ -determined.*

Proof. It is enough to prove \mathcal{L} is $(n + m + 2)$ -determined of Definition 5.1 (3). Let $C \in C_T^{\Theta, Z}(J^1(\mathbb{R}^m \times \mathbb{R}^n, \mathbb{R}), 0)$ be an extension of \mathcal{L} . We may assume that P_C has the form

$$P_C = \{(T, Q, 0, -\frac{\partial H}{\partial T}(T, Q, p) + s, -\frac{\partial H}{\partial Q}, T, -\frac{\partial H}{\partial p}, H - \langle \frac{\partial H}{\partial p}, p \rangle, s, p)\}$$

for some function germ $H(T, Q, p) \in \mathfrak{M}(2n + m)^2$. Then the function germ $F(x, y, t, q, z) = -z + H_0(x, y, t) + \langle y, q \rangle \in \mathfrak{M}(r; n + m + n + 1)$ is a generating family of \mathcal{L} , where $H_0(x, y, t) = H(t, x, 0, y) \in \mathfrak{M}(r; n + m)^2$. We have that F is a reticular t - \mathcal{P} - \mathcal{K} -stable unfolding of $f(x, y, q, z) := -z + H_0(x, y, 0) + \langle y, q \rangle \in \mathfrak{M}(r; n + n + 1)$. This means that

$$\mathcal{E}(r; n + 1 + n + m) = \langle F, x \frac{\partial F}{\partial x}, \frac{\partial F}{\partial y} \rangle_{\mathcal{E}(r; n + 1 + n + m)} + \langle 1, \frac{\partial F}{\partial q} \rangle_{\mathcal{E}(1 + n + m)} + \langle \frac{\partial F}{\partial t} \rangle_{\mathcal{E}(m)}.$$

By the restriction of this to $q = z = 0$, we have that

$$\mathcal{E}(r; n + m) = \langle H_0, x \frac{\partial H_0}{\partial x}, \frac{\partial H_0}{\partial y} \rangle_{\mathcal{E}(r; n + m)} + \langle 1, y_1, \dots, y_n, \frac{\partial H_0}{\partial t} \rangle_{\mathcal{E}(m)}. \quad (8)$$

This means that

$$\mathfrak{M}(r; n + m)^{n + m + 1} \subset \langle H_0, x \frac{\partial H_0}{\partial x}, \frac{\partial H_0}{\partial y} \rangle_{\mathcal{E}(r; n + m)} + \mathfrak{M}(m) \mathcal{E}(r; n + m). \quad (9)$$

Let $C' \in C_T^{\Theta, Z}(J^1(\mathbb{R}^m \times \mathbb{R}^n, \mathbb{R}), 0)$ satisfying $j^{n + m + 2} C(0) = j^{n + m + 2} C'(0)$ be given. There exists a function germ $H'(T, Q, p) \in \mathfrak{M}(2n + 1)$ such that

$$P_{C'} = \{(T, Q, 0, -\frac{\partial H'}{\partial T}(T, Q, p) + s, -\frac{\partial H'}{\partial Q}, T, -\frac{\partial H'}{\partial p}, H' - \langle \frac{\partial H'}{\partial p}, p \rangle, s, p)\}.$$

Since $H = z - qp$ on P_C and $H' = z - qp$ on $P_{C'}$, we have that $j^{n + m + 2} H_0(0) = j^{n + m + 2} H'_0(0)$, where $H'_0(x, y, t) = H'(t, x, 0, y) \in \mathfrak{M}(r; n + m)^2$. By (9) we have that

$$\mathfrak{M}(r; n)^{n + m + 1} \subset \langle H_0, x \frac{\partial H_0}{\partial x}(x, y, 0), \frac{\partial H_0}{\partial y}(x, y, 0) \rangle_{\mathcal{E}(r; n)}$$

and this means that $H_0(x, y, 0)$ is reticular \mathcal{K} -($n+m+2$)-determined by Lemma 2.2. Therefore we may assume that $H_0|_{t=0} = H'_0|_{t=0}$. It follows that $H_0 - H'_0 \in \mathfrak{M}(m)\mathfrak{M}(r; n+m)^{n+m+2}$. Then the function germ $G(x, y, t, q, z) = -z + H'_0(x, y, t) + \langle y, q \rangle \in \mathfrak{M}(r; n+1+n+m)$ is a generating family of $C'|_{\mathbb{L}}$.

We define the function germ $E_{\tau_0}(x, y, t, \tau) \in \mathcal{E}(r; n+m+1)$ by $E_{\tau_0}(x, y, t, \tau) = (1 - \tau - \tau_0)H_0(x, y, t) + (\tau + \tau_0)H'_0(x, y, t)$ for $\tau_0 \in [0, 1]$. By (8) and (9), we have that

$$\mathfrak{M}(r; n+m)^{n+m+2} \subset \langle H_0, x \frac{\partial H_0}{\partial x} \rangle_{\mathcal{E}(r; n+m)} + \mathfrak{M}(r; n+m) \langle \frac{\partial H_0}{\partial y} \rangle + \mathfrak{M}(m) \langle 1, y, \frac{\partial H_0}{\partial t} \rangle. \quad (10)$$

Then we have that

$$\begin{aligned} & \mathfrak{M}_t \mathfrak{M}_{x,y,t}^{n+m+2} \mathcal{E}_{x,y,t,\tau} \\ \subset & \mathfrak{M}_{t,\tau} \langle E_{\tau_0}, x \frac{\partial E_{\tau_0}}{\partial x} \rangle_{\mathcal{E}_{x,y,t,\tau}} + \mathfrak{M}_{t,\tau} \mathfrak{M}_{x,y,t,\tau} \langle \frac{\partial E_{\tau_0}}{\partial y} \rangle \\ & + \mathfrak{M}_{t,\tau}^2 \langle 1, y, \frac{\partial E_{\tau_0}}{\partial t} \rangle + \mathfrak{M}_{t,\tau} \mathfrak{M}_t \mathfrak{M}_{x,y,t}^{n+m+2} \mathcal{E}_{x,y,t,\tau}. \end{aligned}$$

By Malgrange preparation theorem we have that

$$\begin{aligned} \frac{\partial E_{\tau_0}}{\partial \tau} & \in \mathfrak{M}_t \mathfrak{M}_{x,y,t}^{n+3} \subset \mathfrak{M}_t \mathfrak{M}_{x,y,t}^{n+3} \mathcal{E}_{x,y,t,\tau} \\ \subset & \mathfrak{M}_{t,\tau} \langle \langle E_{\tau_0}, x \frac{\partial E_{\tau_0}}{\partial x} \rangle_{\mathcal{E}_{x,y,t,\tau}} + \mathfrak{M}_{x,y,t,\tau} \langle \frac{\partial E_{\tau_0}}{\partial y} \rangle \rangle + \mathfrak{M}_{t,\tau}^2 \langle 1, y, \frac{\partial E_{\tau_0}}{\partial t} \rangle. \end{aligned}$$

for $\tau_0 \in [0, 1]$. Then there exist $\Phi(x, y, t) \in \mathcal{B}_m(r; n+m)$ and a unit $a \in \mathcal{E}(r; n+m)$ and $b_1(t), \dots, b_n(t), c(t) \in \mathfrak{M}(m)$ such that

- (1) Φ has the form: $\Phi(x, y, t) = (x\phi_1(x, y, t), \phi_2(x, y, t), \phi_3(t))$,
- (2) $H_0(x, y, t) = a(x, y, t) \cdot H'_0 \circ \Phi(x, y, t) + \sum_{i=1}^n y_i b_i(t) + c(t)$ for $(x, y, t) \in (\mathbb{H}^r \times \mathbb{R}^{n+m}, 0)$

We define the reticular t - \mathcal{P} - \mathcal{K} -isomorphism (Ψ, d) by

$$\Psi(x, y, t, q, z) = (x\phi_1(x, y, t), \phi_2(x, y, t), \phi_3(t), q(1 - b(t)), z), d(x, y, t, q, z) = a(x, y, t).$$

We set $G' := d \cdot G \circ \Psi \in \mathfrak{M}(r; n+n+m)$. Since $\frac{\partial E_{\tau_0}}{\partial \tau}|_{t=0} = 0$, we have that $a(x, y, 0) = 1$ and $\Phi(x, y, 0) = (x, y, 0)$. Therefore we have that $G'|_{t=0} = f$. Then F and G' are reticular t - \mathcal{P} - \mathcal{K} -infinitesimal versal unfoldings of $F|_{t=0}$. Since G and G' are reticular t - \mathcal{P} - \mathcal{K} -equivalent, it follows that F and G are reticular t - \mathcal{P} - \mathcal{K} -equivalent. Therefore \mathcal{L} and $C'|_{\mathbb{L}}$ are \mathcal{P} -Legendrian equivalent. \blacksquare

Let \mathcal{L} be a stable reticular Legendrian unfolding. We say that \mathcal{L} is *simple* if there exists a representative $\tilde{C} \in C_T(U, J^1(\mathbb{R}^m \times \mathbb{R}^n, \mathbb{R}))$ of a extension of \mathcal{L} such that $\{\tilde{C}_x | x \in U\}$ is covered by finite orbits $[C_1], \dots, [C_l]$ for some \mathcal{P} -contact embedding germs $C_1, \dots, C_l \in C_T(U, J^1(\mathbb{R}^m \times \mathbb{R}^n, \mathbb{R}))$.

Lemma 5.4 (cf., [5, Proposition 5.5]) *A stable reticular Legendrian unfolding \mathcal{L} is simple if and only if for a generating family $F(x, y, t, q, z) \in \mathfrak{M}(r; k+m+n+1)$ of \mathcal{L} , $f(x, y) = F(x, y, 0, 0) \in \mathfrak{M}(r; k)^2$ is a \mathcal{K} -simple singularity.*

Let $J^l(2n+2m+1, 2n+2m+1)$ be the set of l -jets of map germs from $(J^1(\mathbb{R}^m \times \mathbb{R}^n, \mathbb{R}), 0)$ to $(J^1(\mathbb{R}^m \times \mathbb{R}^n, \mathbb{R}), 0)$ and $tC^l(n)$ be the immersed manifold in $J^l(2n+2m+1, 2n+2m+1)$

which consists of l -jets of \mathcal{P} -contact embedding germs. Let $L^l(2n+2m+1)$ be the Lie group which consists of l -jets of diffeomorphism germs on $(J^1(\mathbb{R} \times \mathbb{R}^n, \mathbb{R}), 0)$.

We consider the Lie subgroup $rtLe^l(2n+2m+1)$ of $L^l(2n+2m+1) \times L^l(2n+2m+1)$ which consists of l -jets of reticular \mathcal{P} -diffeomorphisms on the source space and l -jets of \mathcal{P} -Legendrian equivalences of Π at 0:

$$rtLe^l(n, m) = \{(j^l \Psi(0), j^l K(0)) \in L^l(2n+2m+1) \times L^l(2n+2m+1) \mid \\ \Psi_i \text{ is a reticular } \mathcal{P}\text{-diffeomorphism on } (J^1(\mathbb{R} \times \mathbb{R}^n, \mathbb{R}), 0), \\ K \text{ is a } \mathcal{P}\text{-Legendrian equivalence of } \Pi\}.$$

The group $rtLe^l(2n+2m+1)$ acts on $J^l(2n+2m+1, 2n+2m+1)$ and $tC^l(2n+2m+1)$ is invariant under this action.

Let C be a \mathcal{P} -contact diffeomorphism germ on $(J^1(\mathbb{R} \times \mathbb{R}^n, \mathbb{R}), 0)$ and set $z = j^l C(0)$, $\mathcal{L} = C|_{\mathbb{L}}$. We denote the orbit $rtLe^l(2n+2m+1) \cdot z$ by $[z]$. Then

$$[z] = \{j^l C'(0) \in tC^l(2n+2m+1) \mid \mathcal{L} \text{ and } C'|_{\mathbb{L}} \text{ are } \mathcal{P}\text{-Legendrian equivalent}\}.$$

For $\tilde{C} \in C_T(U, J^1(\mathbb{R}^m \times \mathbb{R}^n, \mathbb{R}))$, we define the continuous map $j_0^l \tilde{C} : U \rightarrow tC^l(n)$ by x to the l -jet of \tilde{C}_x . For $C \in C_T(J^1(\mathbb{R}^m \times \mathbb{R}^n, \mathbb{R}), 0)$, we define $j_0^l C : (J^1(\mathbb{R}^m \times \mathbb{R}^n, \mathbb{R}), 0) \rightarrow tC^l(n)$ by the analogous method.

Theorem 5.5 (cf., [5, Theorem 5.4]) *Let \mathcal{L} be a reticular Legendrian unfolding. Let C be an extension of \mathcal{L} and $l \geq (n+m+1)^2$. Then the followings are equivalent:*

- (s) \mathcal{L} is stable.
- (t) $j_0^l C$ is transversal to $[j_0^l C(0)]$.
- (a') $\mathcal{E}_{t,q,p} = B_0 + \langle 1, p_1 \circ C', \dots, p_n \circ C' \rangle_{(\Pi \circ C')^* \mathcal{E}_{t,q,z}} + \langle s \circ C' \rangle_{\mathcal{E}_t} + \mathfrak{M}_{t,q,p}^l$, where $C' = C|_{z=s=0}$ and $B_0 = \langle q_1 p_1, \dots, q_r p_r, q_{r+1}, \dots, q_n \rangle_{\mathcal{E}_{t,q,p}}$,
- (a) $\mathcal{E}_{t,q,p} = B_0 + \langle 1, p_1 \circ C', \dots, p_n \circ C' \rangle_{(\Pi \circ C')^* \mathcal{E}_{t,q,z}} + \langle s \circ C' \rangle_{\mathcal{E}_t}$,
- (is) \mathcal{L} is infinitesimally stable,
- (hs) \mathcal{L} is homotopically stable,
- (u) A generating family F of \mathcal{L} is reticular t - \mathcal{P} - \mathcal{K} -stable unfolding of $F|_{t=0}$.

Proof. We prove only (a') \Rightarrow (a) By the restriction of (a') to $t=0$ we have that:

$$\mathcal{E}_{q,p} = B_1 + \langle 1, p_1 \circ C'', \dots, p_n \circ C'' \rangle_{(\Pi \circ C'')^* \mathcal{E}_{t,q,z}} + \langle s \circ C'' \rangle_{\mathbb{R}} + \mathfrak{M}_{q,p}^l,$$

where $C'' = C'|_{t=0}$ and $B_1 = B_0|_{t=0}$. Then we have that

$$\mathcal{E}_{q,p} = B_1 + (\Pi \circ C'')^* \mathfrak{M}_{t,q,p} \mathcal{E}_{q,p(m)} + \langle 1, p_1 \circ C'', \dots, p_n \circ C'', s \circ C'' \rangle_{\mathbb{R}} + \mathfrak{M}_{q,p}^l.$$

It follows that

$$\mathfrak{M}_{q,p}^{n+m+1} \subset B_1 + (\Pi \circ C'')^* \mathfrak{M}_{t,q,p} \mathcal{E}_{q,p}.$$

Therefore

$$\mathfrak{M}_{t,q,p}^{n+m+1} \subset B_0 \times + (\Pi \circ C')^* \mathfrak{M}_{t,q,p} \mathcal{E}_{q,p} + \mathfrak{M}_t \mathcal{E}_{t,q,p},$$

and we have that

$$\mathfrak{M}_{t,q,p}^l = (\mathfrak{M}_{t,q,p(m)}^{n+m+1})^{n+m+1} \subset B_0 + (\Pi \circ C')^* \mathfrak{M}_{t,q,p}^{n+m+1} \mathcal{E}_{t,q,p} + \mathfrak{M}_t \mathcal{E}_{t,q,p}.$$

It follows that

$$\mathcal{E}_{t,q,p} = B_0 + \langle 1, p_1 \circ C', \dots, p_n \circ C' \rangle_{(\Pi \circ C')^* \mathcal{E}_{t,q,z}} + \langle s \circ C' \rangle_{\mathcal{E}_t} + (\Pi \circ C')^* \mathfrak{M}_{t,q,p}^{n+m+1} \mathcal{E}_{t,q,p} + \mathfrak{M}_t \mathcal{E}_{t,q,p}.$$

This means (a) by Lemma 2.1.

Theorem 5.6 (cf., [5, Theorem 5.6]) *Let $r = 0, n \leq 5, m = 2, 3$ or $r = 1, n \leq 3, m = 2, 3$. Let U be a neighborhood of 0 in $J^1(\mathbb{R}^m \times \mathbb{R}^n, \mathbb{R})$. Then there exists a residual set $O \subset C_T^\Theta(U, J^1(\mathbb{R}^m \times \mathbb{R}^n, \mathbb{R}))$ such that for any $\tilde{C} \in O$ and $w \in U$, the reticular Legendrian unfolding $\tilde{C}_w|_{\mathbb{L}}$ is stable and has a generating family which is stably reticular t - \mathcal{P} - \mathcal{K} -equivalent to one of the types in the classification list below.*

Let $F(x, y, u, t) \in \mathfrak{M}(r; k + n + 2)$ be a reticular t - \mathcal{P} - \mathcal{K} -stable unfolding of $f(x, y)$ be given ($r = 0, n \leq 6$ or $r = 1, n \leq 4$). Since f is simple singularity we may assume that f has the normal form of A, D, E ($r = 0$) or B, C, F ($r = 1$). By analogous method of [3, p.200], we may assume that F has the form

$$F(x, y, u, t) = f(x, y) + a(u_1, \dots, u_n, t)\varphi_0(x, y) + u_1\varphi_1(x, y) + \dots + u_{l-1}\varphi_{l-1}(x, y),$$

where the function germ $f(x, y) + t\varphi_0(x, y) + u_1\varphi_1(x, y) + \dots + u_{l-1}\varphi_{l-1}(x, y) \in \mathfrak{M}(r; k + n + 1)$ is a reticular t - \mathcal{P} - \mathcal{K} -universal unfolding. Since F is also a reticular t - \mathcal{P} - \mathcal{K} -universal unfolding of f , we have that

$$\mathcal{E}_{x,y,u,t} = \langle f, x \frac{\partial f}{\partial x}, \frac{\partial f}{\partial y} \rangle_{\mathcal{E}_{x,y,u,t}} + \langle \varphi_1, \dots, \varphi_{l-1} \rangle_{\mathcal{E}_{u,t}} + \varphi_0 \left(\left\langle \frac{\partial a}{\partial u_1}, \dots, \frac{\partial a}{\partial u_n} \right\rangle_{\mathcal{E}_{u_1, \dots, u_n, t}} + \left\langle \frac{\partial a}{\partial t} \right\rangle_{\mathcal{E}_t} \right).$$

This means that $a(u_1, \dots, u_n, t)$ is a \mathcal{P} - \mathcal{R} -versal unfolding of $a(u_1, \dots, u_n, 0)$ with codimension ≤ 3 . Since the \mathcal{P} - \mathcal{R} -equivalence of a is allowed under the reticular t - \mathcal{P} - \mathcal{K} -equivalence, it follows the classification of \mathcal{P} - \mathcal{R} -versal unfolding of functions on u_1, \dots, u_n of type A_2, A_3 .

We classify $F(x, y, q, t) \in \mathfrak{M}(r; k + n + m)$ with $r = 0, n \leq 6, m = 2$ and $r = 1, n \leq 4, m = 2$.

$$\begin{aligned} &({}^2A_1) \ y^2 + (t_1 + t_2u_1 + u_1^3 \pm u_2^2 \pm \dots \pm u_l^2), \\ &({}^2A_2) \ y^3 + (t_1 + t_2u_2 + u_2^3 \pm u_3^2 \pm \dots \pm u_l^2)y + u_1, \\ &({}^2A_3) \ y^4 + (t_1 + t_2u_3 + u_3^3 \pm u_4^2 \pm \dots \pm u_l^2)y^2 + u_1y + u_2, \\ &({}^2A_4) \ y^5 + (t_1 + t_2u_4 + u_4^3 \pm u_5^2 \pm \dots \pm u_l^2)y^3 + u_1y^2 + u_2y + u_3, \\ &({}^2A_5) \ y^6 + (t_1 + t_2u_5 + u_5^3)y^4 + u_1y^3 + u_2y^2 + u_3y + u_4, \ y^6 + (t_1 + t_2u_5 + u_5^3 \pm u_6^2)y^4 + u_1y^3 + \\ & \ u_2y^2 + u_3y + u_4, \\ &({}^2A_6) \ y^7 + (t_1 + t_2u_6 + u_6^3)y^5 + u_1y^4 + u_2y^3 + u_3y^2 + u_4y + u_5, \\ &({}^2D_4^\pm) \ y_1^2y_2 \pm y_2^3 + (t_1 + t_2u_4 + u_4^3 \pm u_5^2 \pm \dots \pm u_l^2)y_2^2 + u_1y_2 + u_2y_1 + u_3, \\ &({}^2D_5) \ y_1^2y_2 + y_2^4 + (t_1 + t_2u_5 + u_5^3)y_2^3 + u_1y_2^2 + u_2y_2 + u_3y_1 + u_4, \ y_1^2y_2 + y_2^4 + (t_1 + t_2u_5 + u_5^3 \pm \\ & \ u_6^2)y_2^3 + u_1y_2^2 + u_2y_2 + u_3y_1 + u_4, \\ &({}^2D_6^\pm) \ y_1^2y_2 \pm y_2^5 + (t_1 + t_2u_6 + u_6^3)y_2^6 + u_1y_2^3 + u_2y_2^2 + u_3y_2 + u_4y_1 + u_5, \\ &({}^2E_6) \ y_1^3 + y_2^4 + (t_1 + t_2u_6 + u_6^3)y_1y_2^2 + u_1y_1y_2 + u_2y_2^2 + u_3y_1 + u_4y_2 + u_5 \end{aligned}$$

, where $l \leq 6$.

$$\begin{aligned} &({}^2B_2) \ x^2 + (t_1 + t_2u_2 + u_2^3 \pm u_2^2 \pm \dots \pm u_l^2)x + u_1, \\ &({}^2B_3) \ x^3 + (t_1 + t_2u_3 + u_3^3)x + u_1x + u_2, \ x^3 + (t_1 + t_2u_3 + u_3^3 \pm u_4^2)x + u_1x + u_2, \\ &({}^2B_4) \ x^4 + (t_1 + t_2u_4 + u_4^3)x^2 + u_1x^2 + u_2x + u_3, \\ &({}^2C_3^\pm) \ \pm xy + y^3 + (t_1 + t_2u_3 + u_3^2)x + u_1y + u_2, \ \pm xy + y^3 + (t_1 + t_2u_3 + u_3^2 \pm u_4^2)x + u_1y + u_2, \\ &({}^2C_4) \ xy + y^4 + (t_1 + t_2u_4 + u_4^3)y^3 + u_1y^2 + u_2y + u_3, \\ &({}^2F_4) \ x^2 + y^3 + (t_1 + t_2u_4 + u_4^3)xy + u_1x + u_2y + u_3 \end{aligned}$$

, where $l \leq 4$. We give all figures of bifurcations of generic wavefronts with $n = 2, 3$ and $m = 2$: $({}^2A_1)$, $({}^2A_2)$, $({}^2A_3)$, $({}^2B_2)$, $({}^2B_3)$, $({}^2C_3^\pm)$.

We give the positions of the figures as the following way:

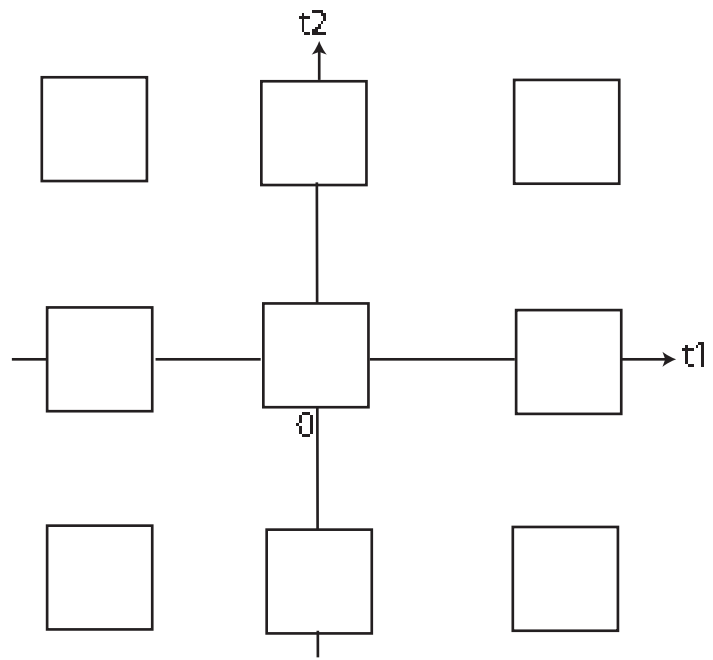



Figure 1: 2A_1



Figure 2: 2A_1

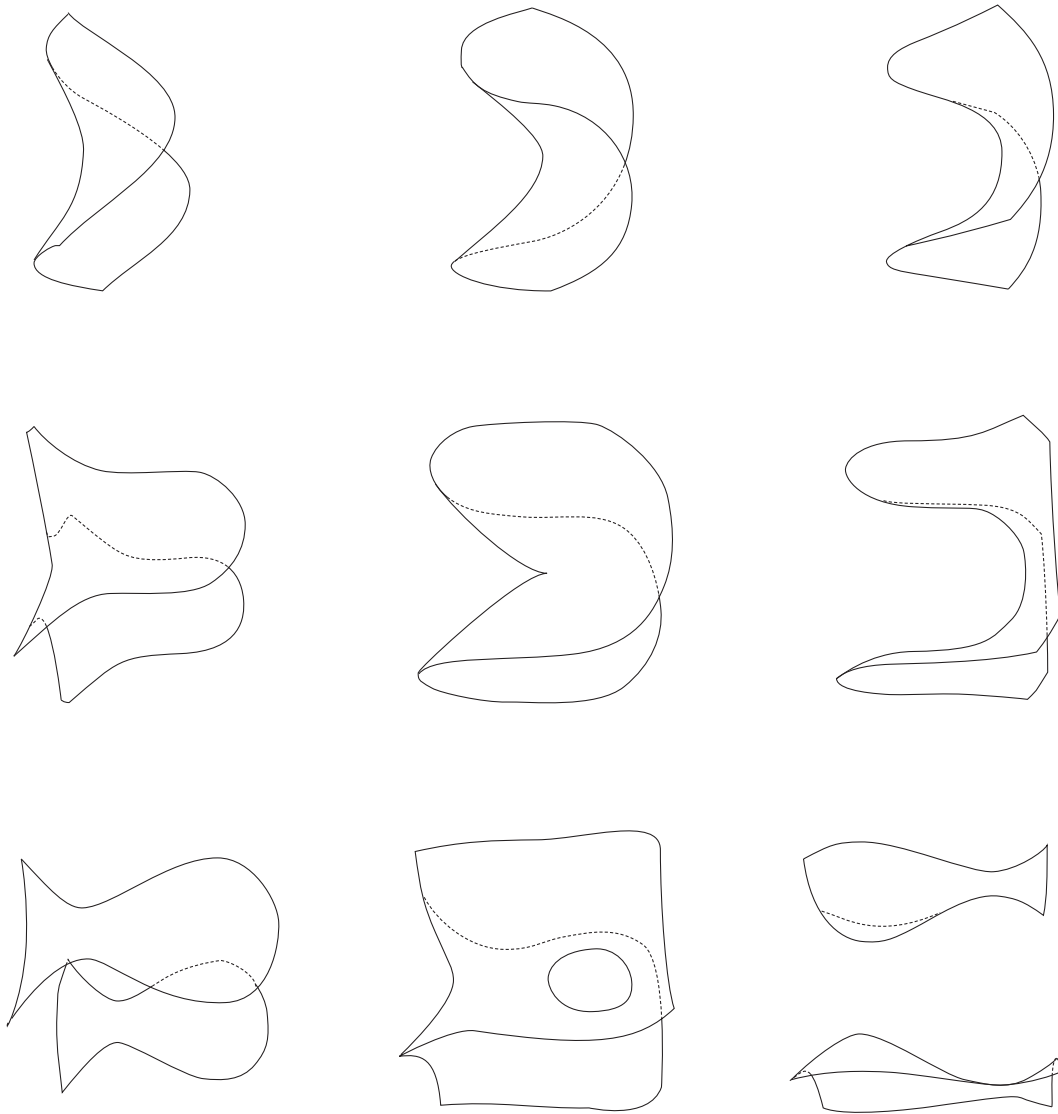

Figure 3: 2A_1

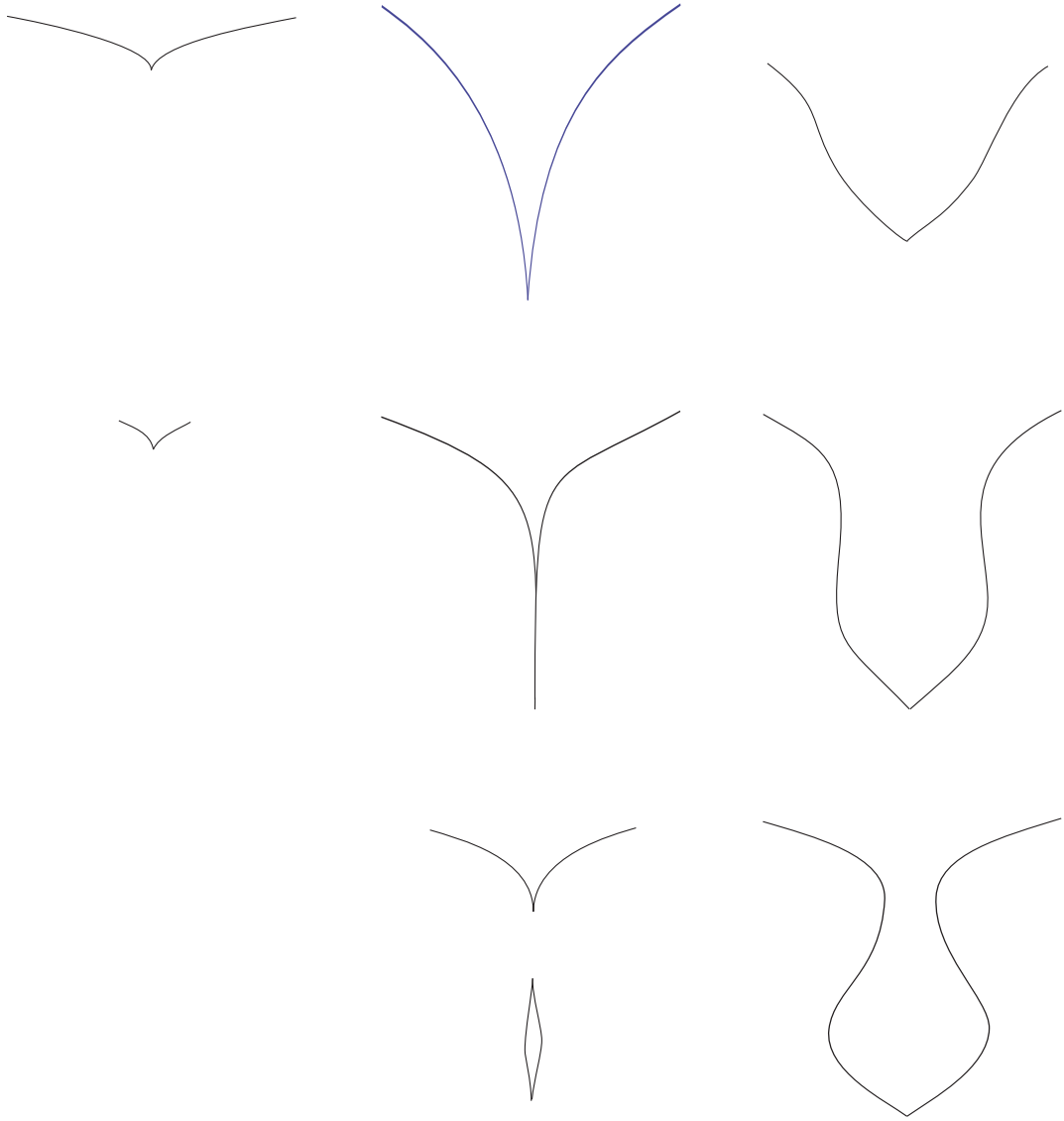

Figure 4: 2A_2

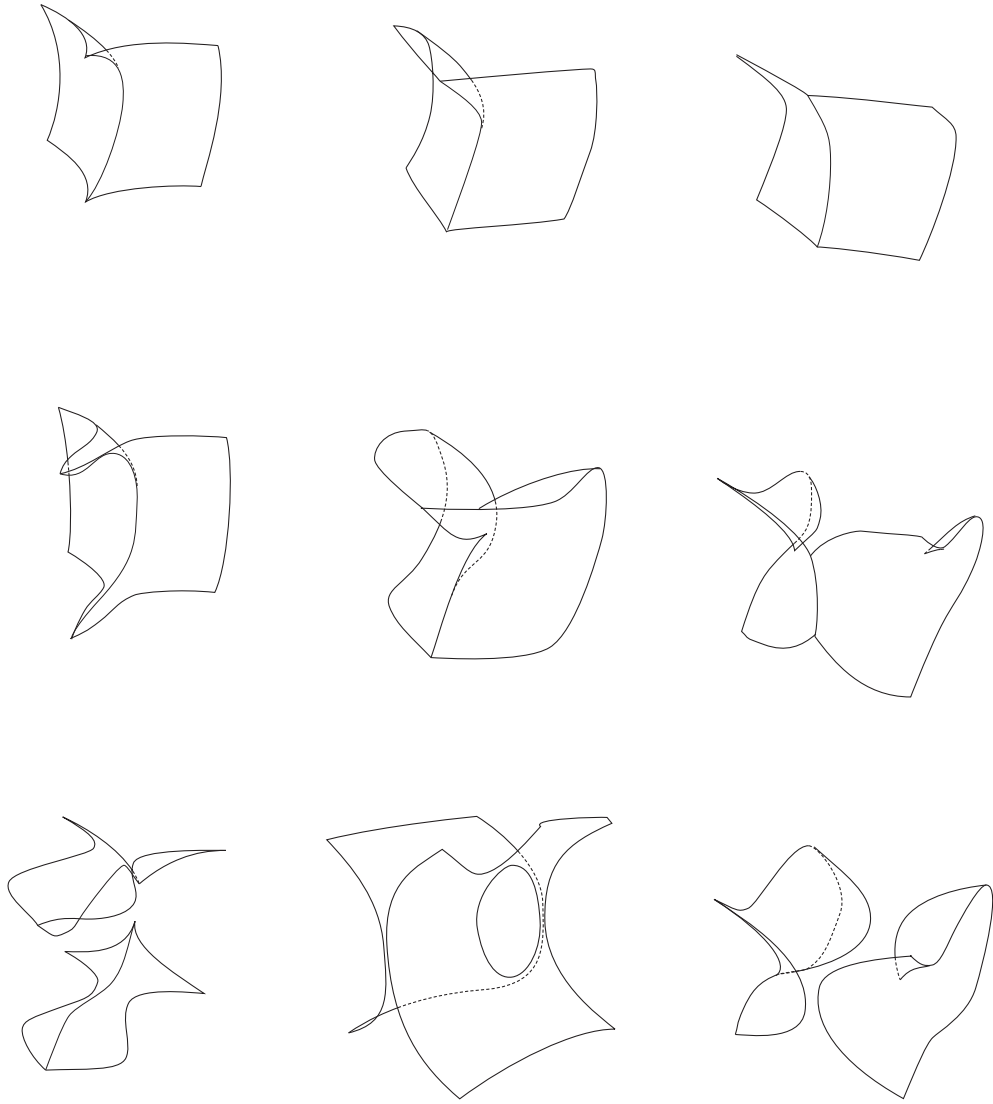

Figure 5: 2A_2

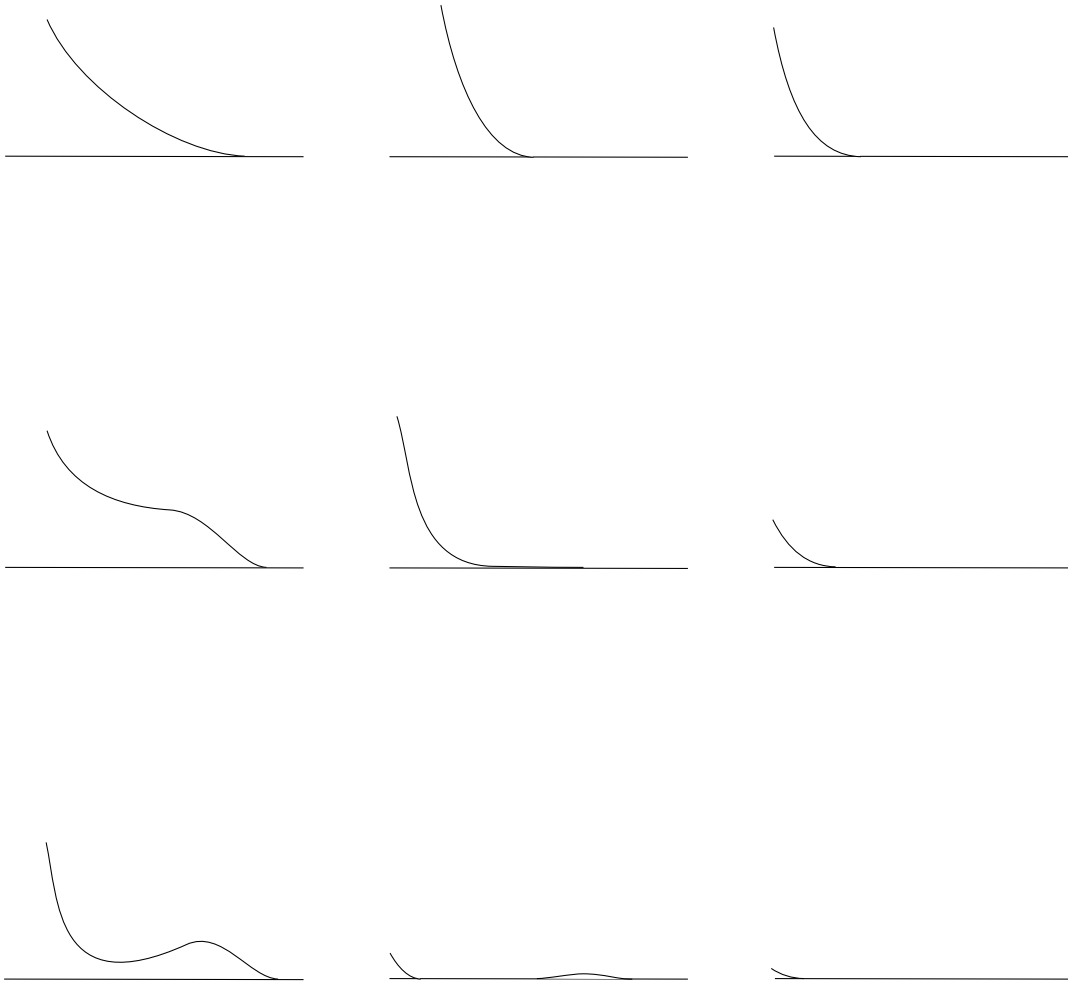

Figure 6: 2B_2

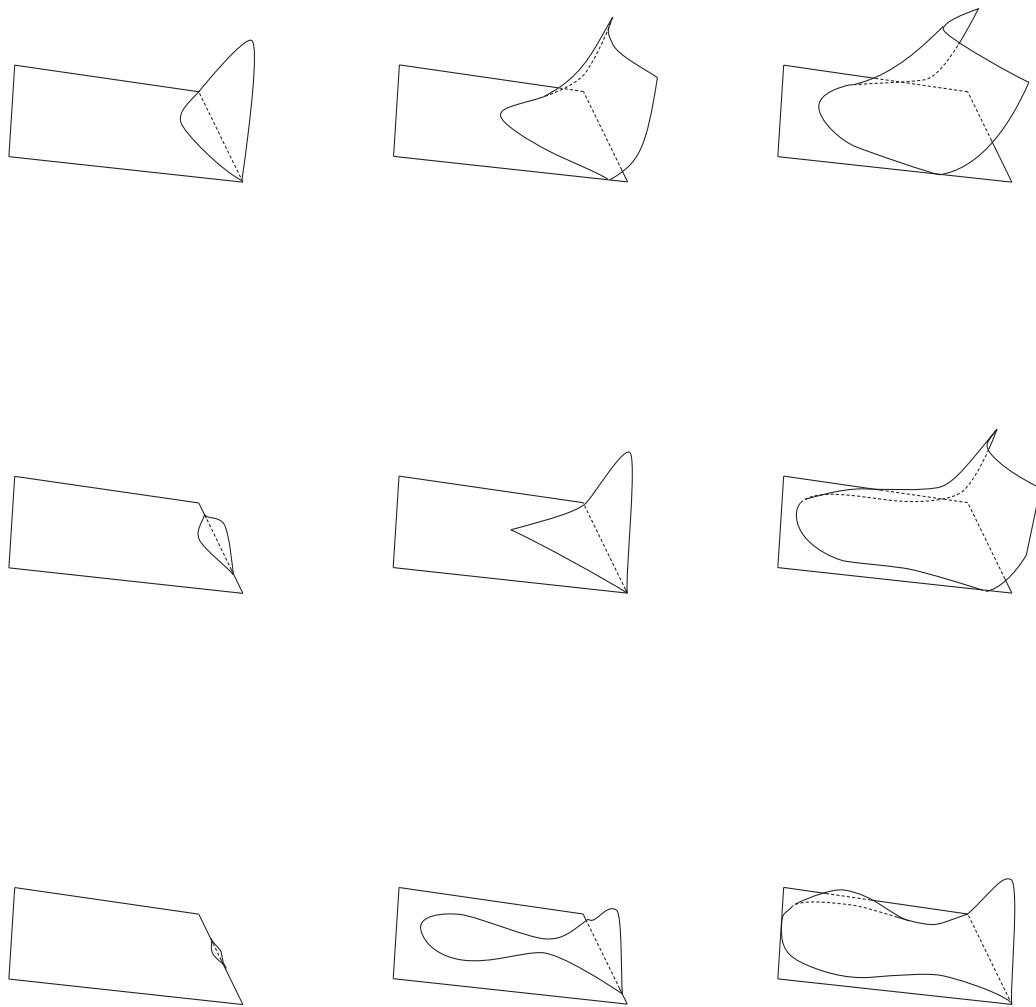

Figure 7: 2B_2

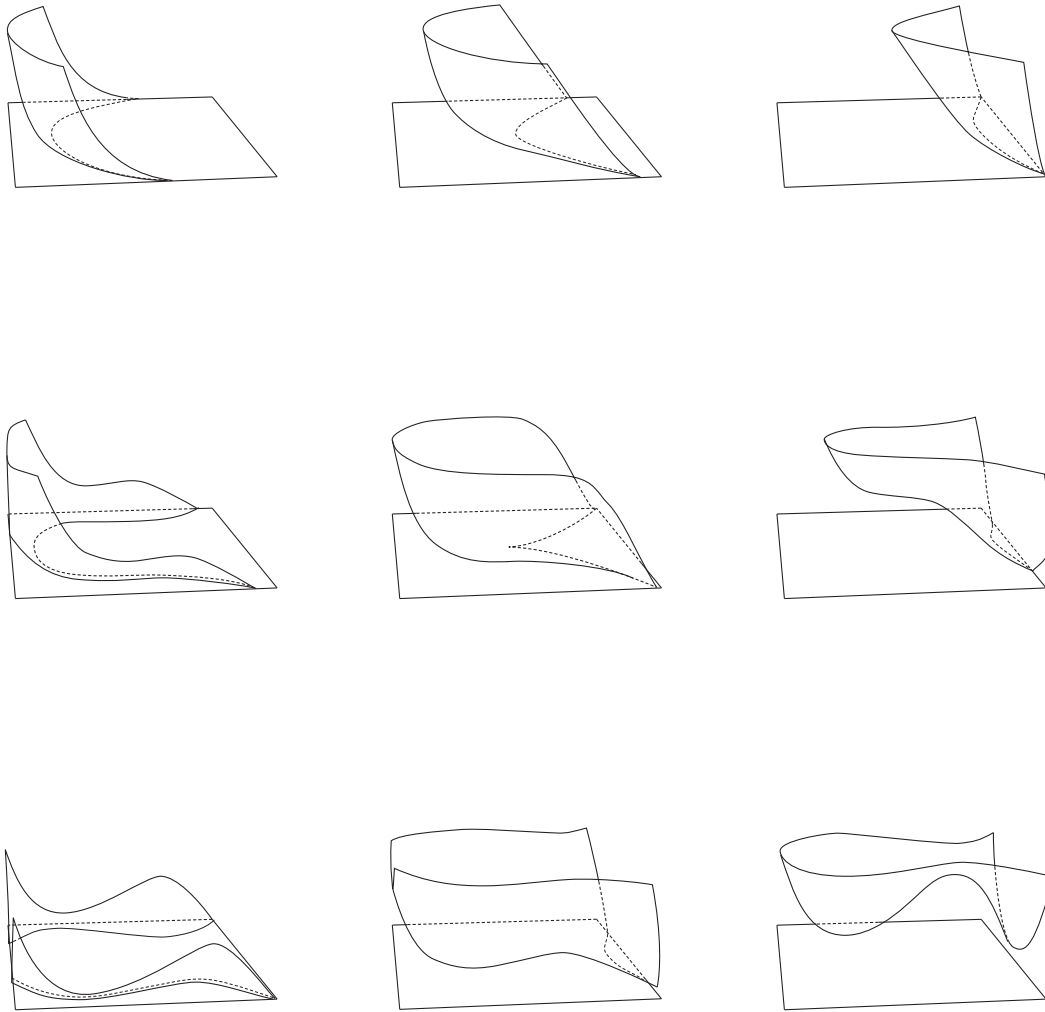

Figure 8: 2B_2

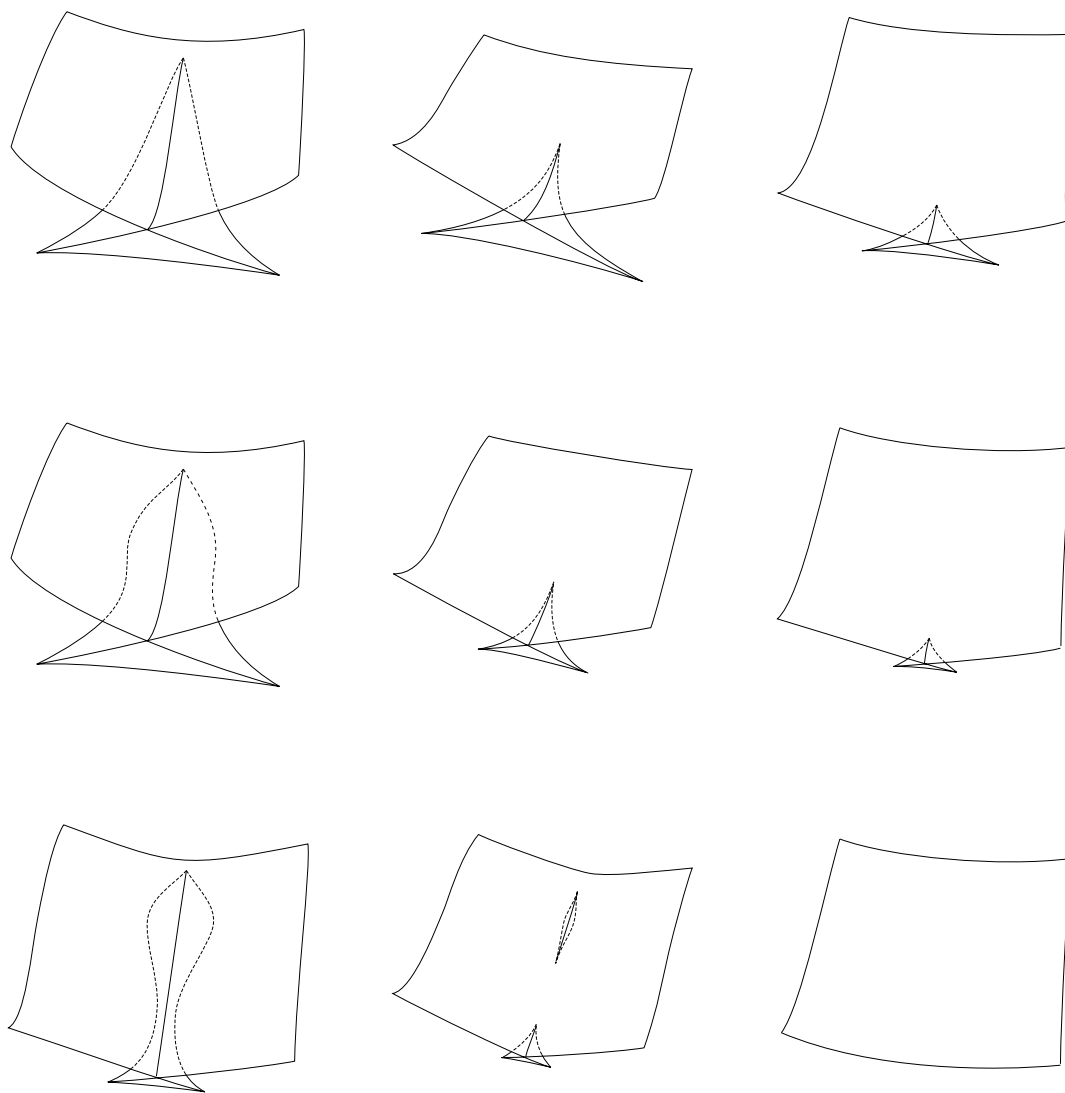

Figure 9: 2A_3



Figure 10: 2B_3

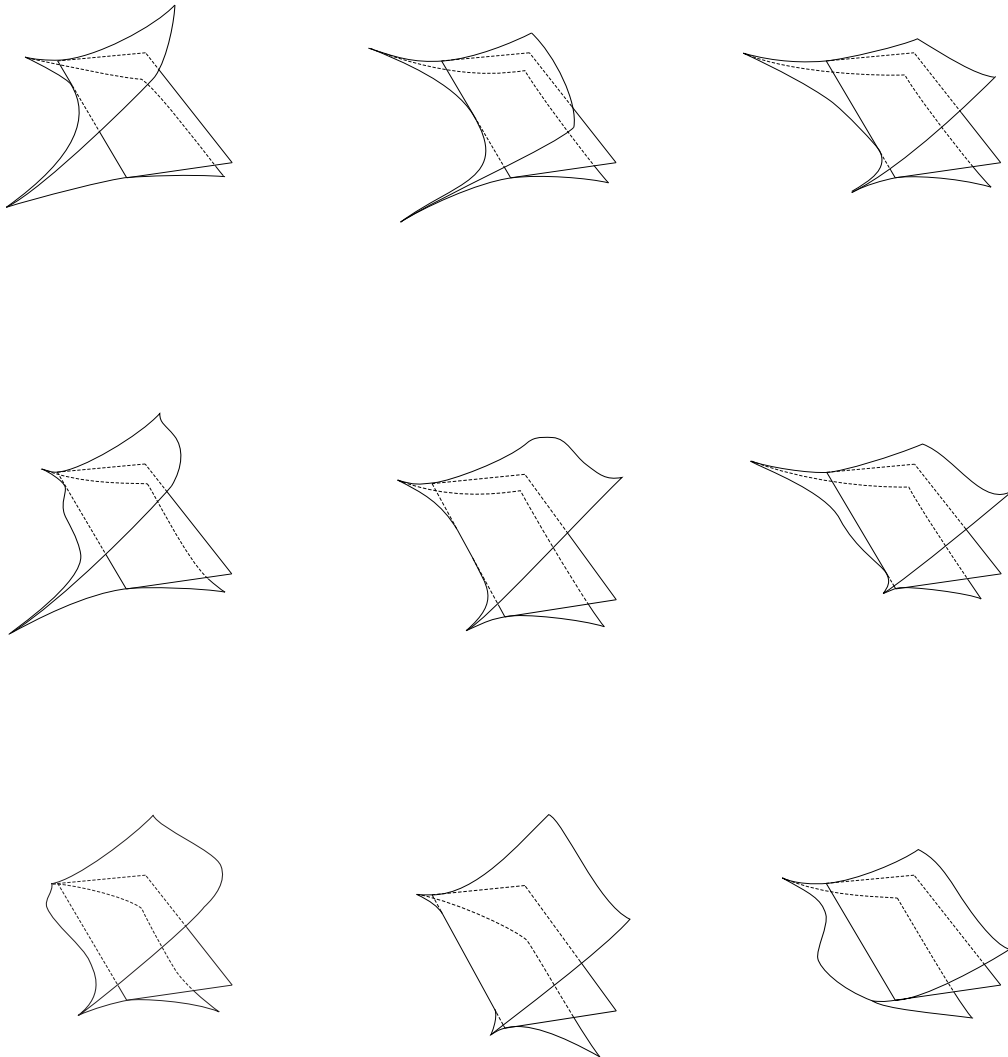

Figure 11: ${}^2C_3^+$

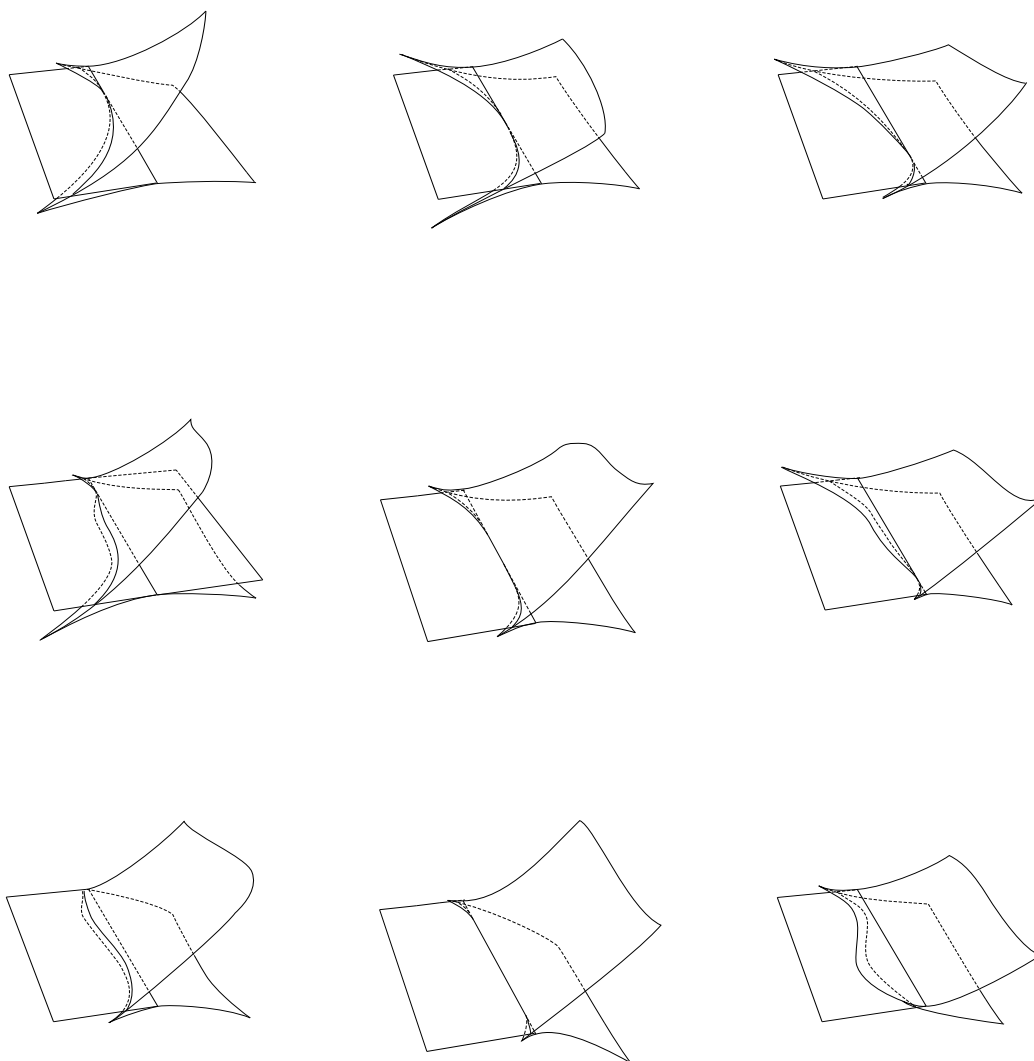

Figure 12: ${}^2C_3^-$

References

- [1] S. Izumiya and G.T.Kossioris. Semi-local classification of geometric singularities for hamilton-jacobi equations. *Journal of Differential equation*, 118:166–193, 1995.
- [2] T. Tsukada. Reticular legendrian singularities. *The Asian J. of Math.*, 5(1):109–127, 2001.
- [3] T. Tsukada. A generic classification of function germs with respect to the reticular t - \mathcal{P} - \mathcal{K} -equivalence. *Hokkaido Math. J.*, 38(1):177–203, 2009.
- [4] T. Tsukada. Genericity of caustics and wavefronts on an r -corner. *Asian J. Math.*, 14(3):335–358, 2010.

- [5] T. Tsukada. Bifurcations of wavefronts on r -corners: semi-local classification. *Methods and Applications of Analysis*, 18(3):303–334, 2011.
- [6] G. Wassermann. Stability of unfolding in space and time. *Acta Mathematica*, 135(1):57–128, 1975.