

AGGREGATION OF COMPOSITE SOLUTIONS: STRATEGIES, MODELS, EXAMPLES

MARK SH. LEVIN

ABSTRACT. The paper addresses aggregation issues for composite (modular) solutions. A systemic view point is suggested for various aggregation problems. Several solution structures are considered: sets, set morphologies, trees, etc. Mainly, the aggregation approach is targeted to set morphologies. The aggregation problems are based on basic structures as substructure, superstructure, median/consensus, and extended median/consensus. In the last case, preliminary structure is built (e.g., substructure, median/consensus) and addition of solution elements is considered while taking into account profit of the additional elements and total resource constraint. Four aggregation strategies are examined: (i) extension strategy (designing a substructure of initial solutions as “system kernel” and extension of the substructure by additional elements); (ii) compression strategy (designing a superstructure of initial solutions and deletion of some its elements); (iii) combined strategy; and (iv) new design strategy to build a new solution over an extended domain of solution elements. Numerical real-world examples (e.g., telemetry system, communication protocol, student plan, security system, Web-based information system, investment, educational courses) illustrate the suggested aggregation approach.

CONTENTS

| | |
|------------------------------------------------------|----|
| 1. Introduction | 2 |
| 2. Auxiliary Problems and Aggregation Strategies | 5 |
| 2.1. Basic Auxiliary Problems | 5 |
| 2.2. Building of “System Kernel” | 6 |
| 2.3. Aggregation Strategies | 7 |
| 3. Examined Structures, Substructure, Superstructure | 9 |
| 3.1. Sets | 10 |
| 3.2. Rankings (Layered Sets) | 10 |
| 3.3. Multisets and Morphological Sets | 10 |
| 3.4. Trees and Morphological Structures | 12 |
| 4. Preliminary Illustrative Example for Notebook | 13 |
| 5. Metrics and Proximities | 17 |
| 5.1. Metric/Proximity for Sets | 17 |
| 5.2. Proximity for Strings/Sequences | 18 |
| 5.3. Proximity for Rankings | 18 |
| 5.4. Proximity for Trees | 21 |
| 5.5. Proximity for Morphological Structures | 23 |

Key words and phrases. composite solution, modular system, aggregation, consensus, agreement, median, structure, ranking, tree, morphological structure, metric, proximity, solving strategy, heuristics, combinatorial optimization, knapsack problem, multiple choice problem, clique, morphological design, decision making, systems engineering, applications.

| | |
|------------------------------------------------------------|----|
| 6. Underlying Problems | 25 |
| 6.1. Multicriteria Ranking | 25 |
| 6.2. Knapsack Problem | 25 |
| 6.3. Knapsack Problem and Compatibility | 26 |
| 6.4. Multiple Choice Knapsack Problem | 27 |
| 6.5. Morphological Design | 27 |
| 7. Median/Consensus Problems and Aggregation Problems | 28 |
| 7.1. Sets | 28 |
| 7.2. Rankings | 29 |
| 7.3. Trees | 31 |
| 7.4. Morphological Structures | 32 |
| 8. Illustrative Applied Numerical Examples | 32 |
| 8.1. ZigBee Communication Protocol | 33 |
| 8.2. On-Board Telemetry System | 37 |
| 8.3. Continuation of Example for Notebook | 39 |
| 8.4. Integrated Security System | 42 |
| 8.5. Common Educational Course | 44 |
| 8.6. Plan of Students Art Activity | 47 |
| 8.7. Combinatorial Investment | 48 |
| 8.8. Configuration of Applied Web-based Information System | 49 |
| 8.9. Modular Educational Course on Design | 53 |
| 8.10. Configuration of Car in Electronic Shopping | 63 |
| 9. Conclusion | 64 |
| References | 66 |

1. INTRODUCTION

Traditional approaches to generation of new design solutions are based on modifications/improvements of existing products/systems (e.g., [37]). Often one existing product/system is used as a basic solution for modification/improvement (e.g., [101], [106], [108], [111], [112], [118], [120], [121]) (Fig. 1.1).

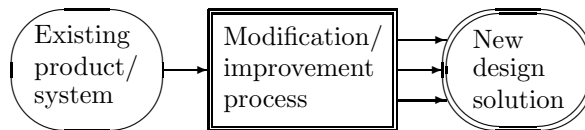

Fig. 1.1. Modification/improvement of existing system

In this article, the generation of a new modular design solution is examined as aggregation of a set of initial existing modular (composite) design solutions. The considered aggregation process is depicted in Fig. 1.2:

Find an aggregated composite solution S^{agg} from a set of initial composite solutions $\{S_1, \dots, S_\tau, \dots, S_m\}$, i.e., $\{S_1, \dots, S_\tau, \dots, S_m\} \implies S^{agg}$.

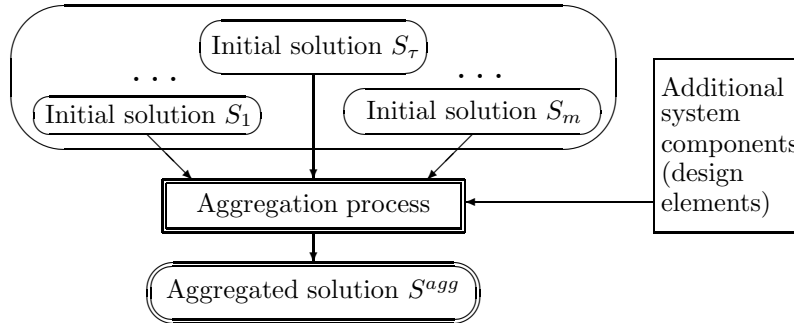

Fig. 1.2. Illustration for aggregation process

Note, the considered aggregation process has to be based on an analysis of engineering and/or management application(s). An expert-based scheme (framework) for problem solving (Fig. 1.3) is used as a basic framework for aggregation of composite (modular) solutions.

Here it is necessary to point out main properties of the expert-based approach:

1. Each operation/step of the solving process has to be executed while taking into account an applied expert-based analysis of the problem situation or subsituation.
2. At each step of the solving process an expert opinion is the most important and the domain expert can correct the solving scheme and intermediate and/or resultant solutions.

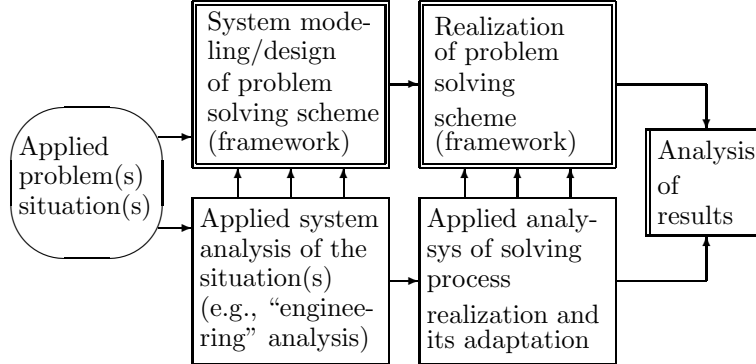

Fig 1.3. Expert-based approach to problem solving

Generally, two aggregation cases have to be considered:

Case 1. Usage of elements from m initial solutions,

Case 2. Usage of elements from m initial solutions and additional design elements from an extended design domain as well.

In *case 1* three solving strategies can be examined. First, the evident strategy consists in an analysis of the set of m initial solutions and building a system substructure (“system kernel” K , e.g., a “basic system part” as substructure, median/consensus of the initial solutions) that can be extended or modified. Several methods can be used to build the “system kernel” K : (a) substructure of the initial solutions, (b) median structure (or consensus/agreement) for the initial solutions, (c) extended substructure, (d) extended median structure (or extended consensus). (e) selection of the “best” system element for each specified system part.

Here expert judgment of expert(s) domain can be used at each stage of the solving process.

Second, a superstructure for set of m initial solutions has to be designed Ω (e.g., combining the initial solutions, “covering” the initial solutions). Then, the superstructure is compressed via deletion of the less important elements.

In *case 2*, it is possible to consider the following:

to build a generalized domain of design alternatives (i.e., solution elements) and to design a new solution (including usage of new design elements).

Here the extended design domain may be obtained via the following two ways: (a) covering/approximation of m initial solutions by a new design alternative domain, (b) examination of a new design alternative domain.

In the article, the following structures will be examined as basic ones: (i) sets (e.g., [93]), (ii) rankings (e.g., [29], [35], [36], [101]), (iii) set morphologies (e.g., [9], [84], [101], [106], [108], [110], [175]), (iv) trees (e.g., [57], [69], [93]).

General structure (i.e., system model) (Λ) is: $\Lambda = \langle \mathbf{T}, \mathbf{P}, \mathbf{D}, \mathbf{R}, \mathbf{I} \rangle$, where the following parts are considered ([101], [106], [108]): (i) tree-like system model \mathbf{T} , (ii) set of leaf nodes as basic system parts/components \mathbf{P} , (iii) sets of DAs for each leaf node \mathbf{D} , (iv) DAs rankings (i.e., ordinal priorities) \mathbf{R} , and (v) compatibility estimates between DAs \mathbf{I} . Fig. 1.4 illustrates the generalized architecture (structure) of examined modular systems/solutions (Λ). Note the following significant structures are considered as well: (a) morphology: $\Phi = \langle \mathbf{P}, \mathbf{D} \rangle$; (b) morphological set: $\bar{\Phi} = \langle \mathbf{P}, \mathbf{D}, \mathbf{R}, \mathbf{I} \rangle$; (c) morphological structure (tree): $\tilde{\Phi} = \langle \mathbf{T}, \mathbf{P}, \mathbf{D}, \mathbf{R} \rangle$; (d) morphological structure with compatibility (i.e., with compatibility of DAs): $\hat{\Phi} = \langle \mathbf{T}, \mathbf{P}, \mathbf{D}, \mathbf{R}, \mathbf{I} \rangle$.

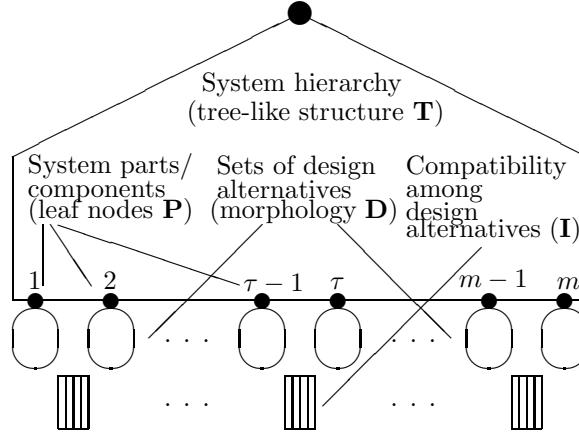

Fig 1.4. Architecture of modular system (Λ)

In Table 1.1, building problems for basic substructures/superstructures are briefly pointed out.

Finally, two basis system problems are faced: (a) revelation/design of “system kernel”, (b) building an extended design alternative domain. Four solving aggregated strategies are considered:

(1) extension strategy: designing “system kernel” based on set of initial solutions (e.g., substructure, median/consensus) and extension of “system kernel” by additional elements;

(2) compression strategy: designing a superstructure of initial solutions and deletion of some its elements; and

(3) combined strategy (extension, deletion, and replacement operations for system elements over a preliminary aggregated solution), and

(4) design strategy: building an extended design domain of solution elements and designing a new solution.

The above-mentioned strategies are based on combinatorial models (as underlying problems): multicriteria ranking/selection, knapsack problem, multiple choice knapsack problem, combinatorial morphological synthesis.

The suggested approaches are illustrated through numerical examples including applied examples (e.g., telemetry system, communication protocol, hierarchical security system, plan of students art activity, combinatorial investment, Web-based information system, notebook, educational courses).

Table 1.1. Basic structures and bibliography references

| Initial structures | Target structure | References |
|--------------------|--------------------------------------------------------------------------|-----------------------------------------------------------------------------------------------------------------------------------|
| Sets | Subset, superset | [2], [77] |
| Strings/sequences | Common subsequence, common supersequence, median string, consensus | [4], [5], [8], [13], [18], [21], [46], [55], [65], [74], [78], [82], [85], [126], [129], [130], [135], [143], [145], [151], [153] |
| Rankings | (i) Consensus/median (ii) Fuzzy ranking | [12], [16], [35], [34], [36], [50], [72], [88], [89] [71], [91], [100], [101] |
| Trees | (i) Agreement/consensus tree (ii) Agreement forest (iii) Supertree | [2], [3], [19], [52], [54], [76], [133], [146] [30], [66], [138], [164], [165] [19], [43], [75], [142] |
| Graphs | Common subgraph, common supergraph | [53], [81], [104], [106] |

2. AUXILIARY PROBLEMS AND AGGREGATION STRATEGIES

2.1. Basic Auxiliary Problems. In the case of two initial solutions as element sets A_1 and A_2 , Fig. 2.1 illustrates substructure $\tilde{S}_{A_1A_2} \subseteq (A_1 \& A_2)$ and superstructure $\bar{S}_{A_1A_2} \supseteq (A_1 \cup A_2)$ (via Venn-diagram).

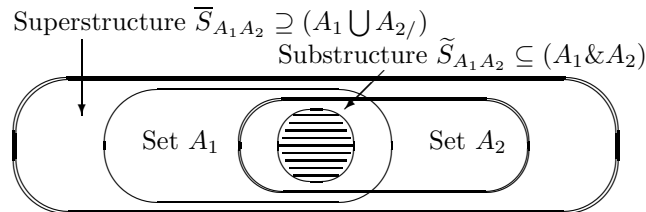

Fig. 2.1. Illustration for substructure, superstructure

Further, let $S = \{S_1, \dots, S_i, \dots, S_n\}$ be a set of initial solutions (structures). Let function $\rho(S_{i_1}, S_{i_2})$, $i_1, i_2 \in \{1, 2, \dots, n\}$ be a proximity or a metric for the solutions. The following main basic auxiliary problems can be examined:

Problem 1. Find a maximum substructure:

$$\tilde{S} = \arg \max_{\{S'\}} (|S'|), \forall S' \in \bigcap_{i=1}^n S_i.$$

Problem 2. Find a minimum superstructure

$$\bar{S} = \arg \min_{\{S''\}} (|S''|), \forall S'' \in \bigcup_{i=1}^n S_i.$$

Now let us consider definitions of medians for the above-mentioned set of initial sets S (e.g., [40], [82], [130], [145]):

(a) median (“generalized median”) M^g is:

$$M^g = \arg \min_{M \in D} \left(\sum_{i=1}^n \rho(M, D_i) \right),$$

where D ($D \supseteq S$) is a set of structures of a specified kind (searching for the median is usually NP complete problem);

(b) simplified case of median (an approximation) as “set median” M^s over set S :

$$M^s = \arg \min_{M \in S} \left(\sum_{i=1}^n \rho(M, S_i) \right).$$

Here a representative from $S = \{S_1, \dots, S_i, \dots, S_n\}$ is searched for. Computation of proximity $\rho(M, S_i)$ is usually NP-complete problem as well. Note a similar “closest string problem” is widely applied in bioinformatics (e.g., [59], [62], [63], [87], [122], [125], [163]). Finally, the following problem 3 and problem 4 can be considered:

Problem 3. Find “set median” M^s .

Problem 4. Find “median” (“generalized median”) M^g .

Problem 5. Find an extended median/consensus structure via addition to (or correction/editing of) the basic median/structure some elements while some resource constraint(s). Here some elements are added to the median set (problem 3 or 4) while taking into account profit and required resource for the addition.

The problems are considered for the following kinds of structures: (i) sets, (ii) *set morphologies*, (iii) trees, and (iv) trees with *set morphologies*. In the case of vector-like metric/proximity $\rho(S_{i_1}, S_{i_2})$, Pareto-efficient solutions are searched for in problem 3, problem 4, and problem 5.

2.2. Building of “System Kernel”. The basic auxiliary problem consists in designing the “system kernel”. Several methods can be used to build the “system kernel” K :

- (i) substructure of the initial solutions,
- (ii) median structure (or consensus/agreement) for the initial solutions,

(iii) extended substructure (or extended median structure, extended consensus), and

(iv) a two-stage framework: (a) specifying a set of basic system parts (as a subset of the system parts/components), (b) selection of the “best” system elements for each specified basic system part above.

Sometimes, a subsolution (i.e., “system kernel” as substructure) is a very small subset. In this case, it is reasonable to use a special (more “soft”) method to select elements for “system kernel”. Let $S = \{S_1, \dots, S_i, \dots, S_n\}$ be a set of initial solutions (structures). Then, element e will be included into (added to) “system kernel” if $\eta_i \geq \alpha$ (e.g., $\alpha \geq 0.5$) where η_e is the number of initial solutions which involve element e . The usage of this rule will lead to an extension of the basic method for building the system substructure.

2.3. Aggregation Strategies. Four basic aggregation strategies are examined: (i) extension strategy (extension of “system kernel”), (ii) deletion strategy (compression of a superstructure for initial solutions), (iii) combined strategy (i.e., extension, deletion, and replacement operations for system elements over a preliminary aggregated solution), and (iv) design strategy (new system design).

The extension strategy is the following:

Type I. Extension strategy:

Phase 1.1. Analysis of applied problem, initial solutions, resources, solution elements.

Phase 1.2. Revealing from m initial solutions a basis as a subsolution or “system kernel” K (e.g., subset of elements, substructure, median/consensus).

Phase 1.3. Forming a set of additional solution elements which were not included into the basis above.

Phase 1.4. Selection of the most important elements from the set of additional elements while taking into account the following: (i) profit of the selected elements, (ii) total resource constraint(s), (iii) compatibility among the selected elements and elements of the basis (i.e., “system kernel”).

Phase 1.5. Analysis of the obtained aggregated solution(s).

Fig. 2.2 illustrates the extension strategy.

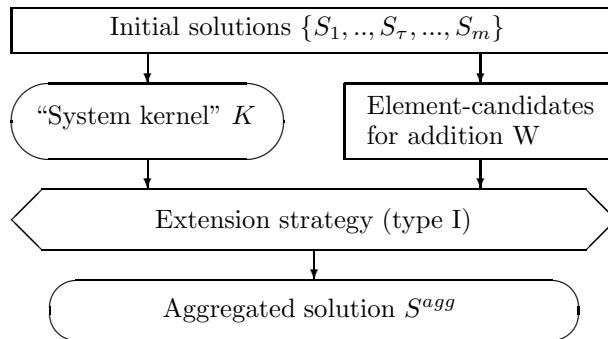

Fig 2.2. Scheme of extension strategy

The second (compression) strategy is based on preliminary union of all elements of m initial solutions and deletion of the non-important elements to satisfy some resource constraint(s) (Fig. 2.3):

Type II. Compression (deletion) strategy:

Phase 2.1. Analysis of applied problem, initial solutions, resources, solution elements.

Phase 2.2. Union of all elements from m initial solutions to form a basic super-solution (e.g., superset of elements, superstructure).

Phase 2.3. Forming a set of element candidates to delete.

Phase 2.4. Selection of the most non-important elements from the set of element candidates while taking into account the following: (i) integrated profit of the compressed solution, (ii) total resource constraint(s), (iii) compatibility among the selected elements of the compressed solution.

Phase 2.5. Analysis of the obtained aggregated solution(s).

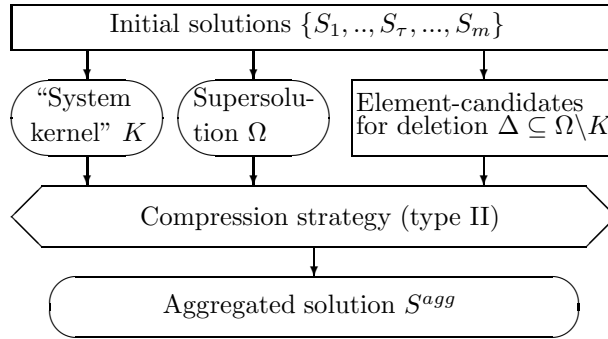

Fig 2.3. Scheme of compression strategy

The third strategy is consists in possible combination of addition operations, deletion operation, and correction (replacement) operations. The third strategy is (Fig. 2.4):

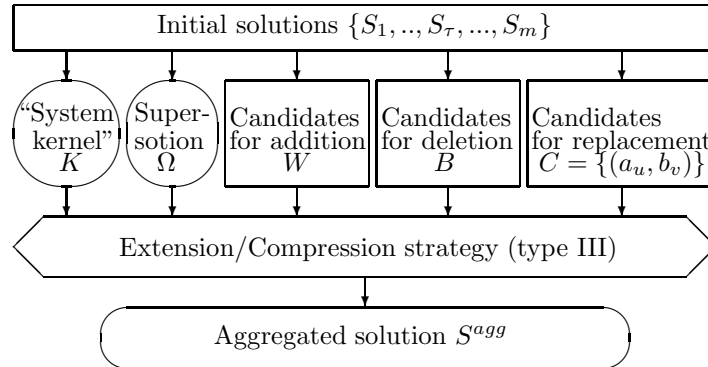

Fig 2.4. Scheme of extension/compression strategy

Type III. Combined strategy:

Phase 3.1. Analysis of applied problem, initial solutions, resources, solution elements.

Phase 3.2. Revealing from m initial solutions a basis as a subsolution or “system kernel” K (e.g., subset of elements, substructure, median/consensus).

Phase 3.3. Forming the following:

(a) a set of additional solution elements as candidates for addition W which were not included into the basis above ($|W \cap K| = 0$),

(b) a subset $B \subseteq K$ as candidates for deletion, and

(c) a set of element pair $C = \{(a_u, b_v) | (a_u \in K) \& (b_v \notin K)\}$, thus a set of correction operations is considered as replacement of a_u by b_v .

Phase 3.4. Selection of the most important operations (including element addition, element deletion, and element replacement) while taking into account the following: (i) profit of the operations, (ii) total resource constraint(s), (iii) compatibility among the selected elements in the resultant solution.

Phase 3.5. Analysis of the obtained aggregated solution(s).

The fourth strategy is targeted to usage of additional elements from an extended design domain (“design space”). Here the resultant aggregated solution may involve elements which were not belonging to m initial solutions. The fourth strategy is:

Type IV. Strategy of extended design domain:

Phase 4.1. Analysis of applied problem, initial solutions, resources, solution elements.

Phase 4.2. Extension of the union of all elements from m initial solutions to form an extended design element domain (“design space”).

Phase 4.3. New design of the composite solution over the obtained design element domain while taking into account the following: (i) profit of the designed solution, (ii) total resource constraint(s), (iii) compatibility among the selected (i.e., resultant) elements of the compressed solution.

Phase 4.4. Analysis of the obtained aggregated solution(s).

Fig. 2.5 illustrates the fourth strategy. Given three initial solutions S_1 , S_2 , and S_3 . The resultant aggregated solution S^{agg} can involve elements from solution S_1 , S_2 and elements from the extended design domain.

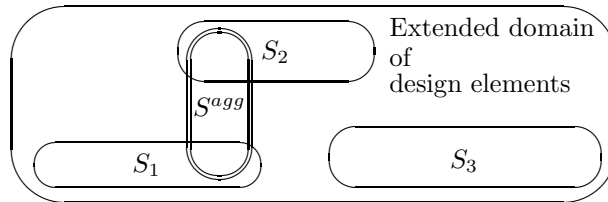

Fig. 2.5. Illustration for aggregation design strategy

3. EXAMINED STRUCTURES, SUBSTRUCTURE, SUPERSTRUCTURE

Generally, the following basic kinds of sets are examined: sets, multisets, lists, complete lists, and trees (e.g., [43], [93], [147]). In this material, our main examination is targeted to special kinds of composite structures: *morphological structures*.

3.1. **Sets.** Evidently, sets are basic structures. Fig. 3.1 depicts a numerical example of two initial sets A and B .

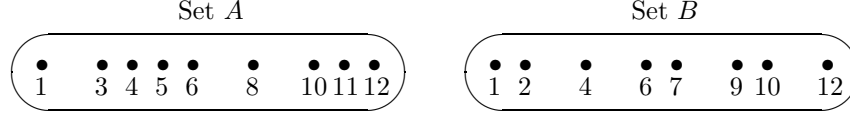

Fig. 3.1. Illustration: two initial sets

Fig. 3.2 contains examples of subset \tilde{S}_{AB} and superset \bar{S}_{AB} .

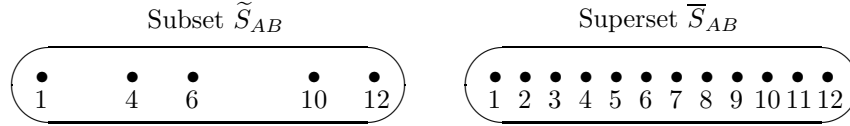

Fig. 3.2. Illustration: subset and superset

Now let us consider the case of m sets. Let $\{A_1, \dots, A_i, \dots, A_m\}$ be initial sets. Then, a subset is: $\tilde{S}_{\{A_i\}} \subseteq \bigcap_{i=1}^m A_i$. A superset is: $\bar{S}_{\{A_i\}} \supseteq \bigcup_{i=1}^m A_i$.

3.2. **Rankings (Layered Sets).** Here ranking is examined as a layered set. Let $A = \{1, \dots, i, \dots, n\}$ be a set of elements/items. Ranking (a partial order/partition of set A) is considered as linear ordered subsets of A (Fig. 3.3): $A = \bigcup_{k=1}^m A(k)$, $|A(k_1) \cap A(k_2)| = 0$ if $k_1 \neq k_2$, $i_2 \preceq i_1 \forall i_1 \in A(k_1), \forall i_2 \in A(k_2), k_1 \leq k_2$. Set $A(k)$ is called layer k , and each item $i \in A$ gets priority r_i that equals the number of the corresponding layer. The described partition of A is called as partial ranking, stratification, layered set (e.g., [17], [42], [98], [100], [101], [106], [115], [139], [173]). Evidently, a linear order of elements from A is ranking as well. Many years ranking problems (or sorting) have been intensively used and studied in various domains (e.g., [17], [23], [42], [29], [88], [89], [106], [115], [139], [173], [174]).

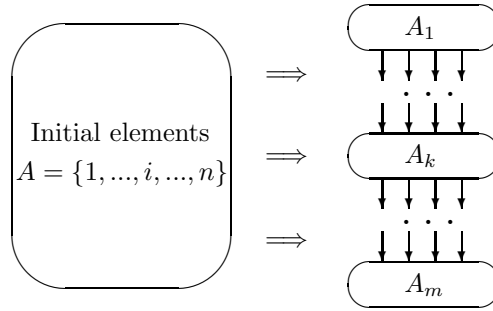

Fig. 3.3. Scheme of ranking

3.3. **Multisets and Morphological Sets.** Now let us consider two kinds of basic structures: multiset and morphological set.

Let U be a universe (collection of all relevant items) and N be a set of non-negative integers (e.g., $N = \{1, \dots, \tau, \dots, m\}$). Formally, multiset is a mapping:

$$\Gamma : U \longrightarrow N.$$

Clearly, three basic operations can be considered for sets and multisets:

1. unions: $A \cup B$ (for sets A and B , analogically for multisets),
 2. intersections: $A \cap B$ (for sets A and B , analogically for multisets), and
 3. complements: $A \setminus B$ (for sets A and B , analogically for multisets).
- A macroset is a (finite or infinite) set of multisets over a finite alphabet.
Generally, *morphological set* is defined as follows:

Definition 3.1. *Morphological set* is a structure consisting of:

1. a finite set of integers $N = \{1, \dots, \tau, \dots, m\}$ (each integer τ corresponds to a system part);
 2. set of elements (alternatives) for each system part τ :
 $A_\tau = \{A_{\tau 1}, \dots, A_{\tau \xi}, \dots, A_{\tau q_\tau}\}$, where $A_{\tau \xi}$ is a design alternative;
 3. preference relation over elements of A_τ (or estimates upon a set of specified criteria or resultant ordinal priorities for each alternative $p(A_{\tau \xi})$); and
 4. weighted (by ordinal scale) binary relation of *compatibility* for each pair of system parts $(\alpha, \beta) \in N$ over elements of alternative sets A_α, A_β : R_{A_α, A_β} .
- A composite system consisting of m parts is examined (Fig. 3.4) ([101],[106],[110]).

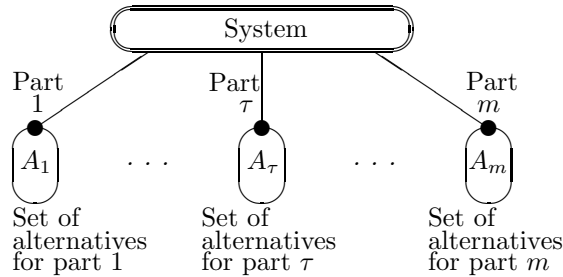

Fig. 3.4. Illustration for multi-part system

Thus, *system morphology* S_A (or morphology Φ) is defined as follows $A = \{A_1, \dots, A_\tau, \dots, A_m\}$ (Fig. 3.5).

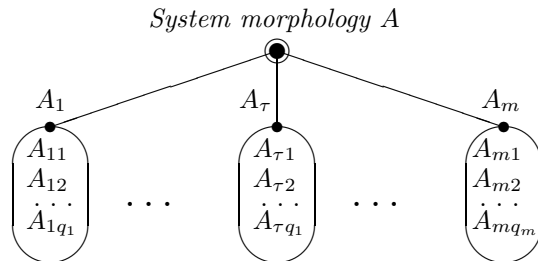

Fig. 3.5. Illustration: *system morphology*

Further, numerical examples for two morphologies are presented: morphology A^1 (Fig. 3.6), morphology A^2 (Fig. 3.7), sub-morphology \tilde{S}_{A^1, A^2} (Fig. 3.8), and super-morphology \bar{S}_{A^1, A^2} (Fig. 3.9).

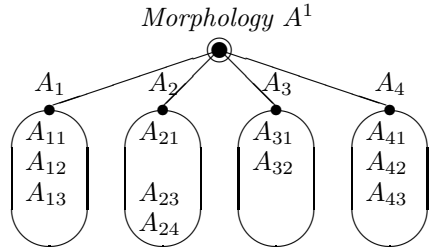

Fig. 3.6. Example of morphology A^1

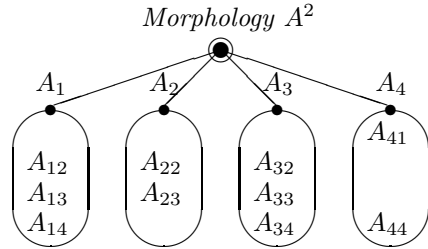

Fig. 3.7. Example of morphology A^2

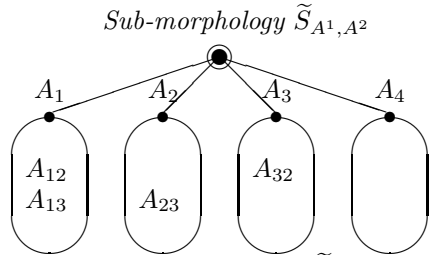

Fig. 3.8. Sub-morphology \tilde{S}_{A^1, A^2}

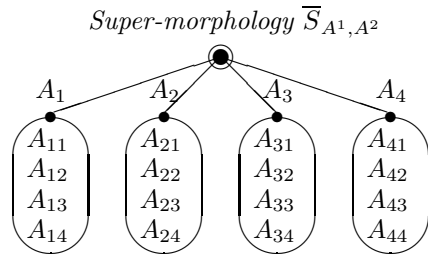

Fig. 3.9. Super-morphology \bar{S}_{A^1, A^2}

In addition, tables of ordinal compatibility estimates have to be considered. The aggregation of estimates (by element) can be based on a special operation (e.g., minimal value of element). Table 3.1 presents an illustrative numerical example for compatibility estimates and their aggregation.

Table 3.1. Aggregation of compatibility estimates for A^1, A^2 : nodes A_1, A_2

| Morphology A^1 | | Morphology A^2 | | Super-morphology \bar{S}_{A^1, A^2} | | | | |
|------------------|----------|------------------|----------|---------------------------------------|----------|----------|----------|----------|
| | A_{21} | A_{23} | A_{24} | | A_{21} | A_{22} | A_{23} | A_{24} |
| A_{11} | 0 | 1 | 2 | A_{11} | 0 | — | 1 | 2 |
| A_{12} | 3 | 2 | 1 | A_{12} | 3 | 2 | 2 | 1 |
| A_{13} | 2 | 3 | 1 | A_{13} | 2 | 1 | 2 | 1 |
| | | | | A_{24} | — | 2 | 2 | — |

3.4. Trees and Morphological Structures. Now let us consider trees and morphological structures (as morphological trees). Fig. 3.10 illustrates a numerical example for two trees T_1 and T_2 .

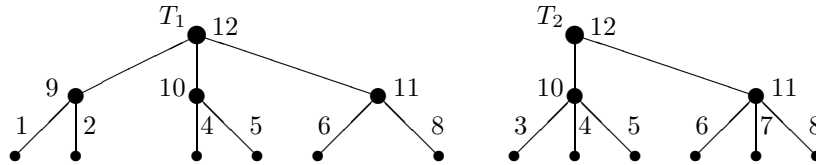

Fig. 3.10. Illustration for two initial trees

Fig. 3.11 depicts corresponding examples of supertree \bar{T} and subtree \tilde{T} .

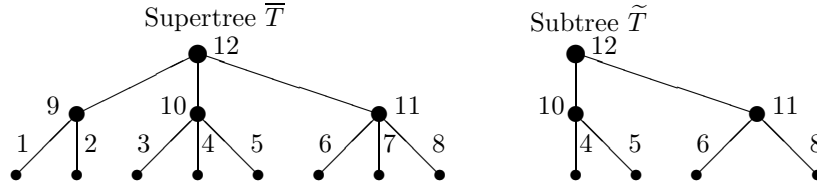

Fig. 3.11. Illustration for supertree and subtree

Now let us consider trees with morphologies. Fig. 3.12 illustrates two trees with morphologies Θ_1 and Θ_2 .

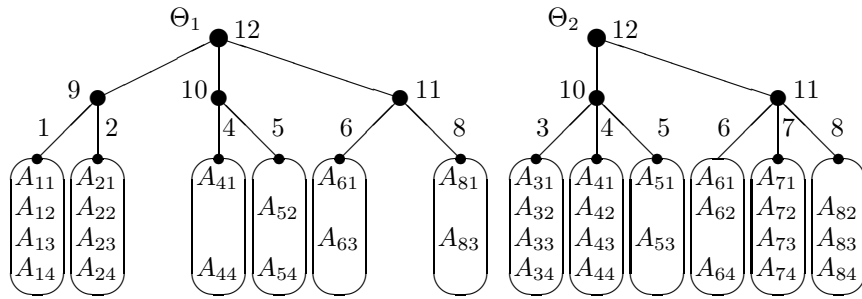

Fig. 3.12. Illustration for two initial trees & morphologies

Fig. 3.13 illustrates examples of supertree and subtree with morphologies $\bar{\Theta}$ and $\tilde{\Theta}$.

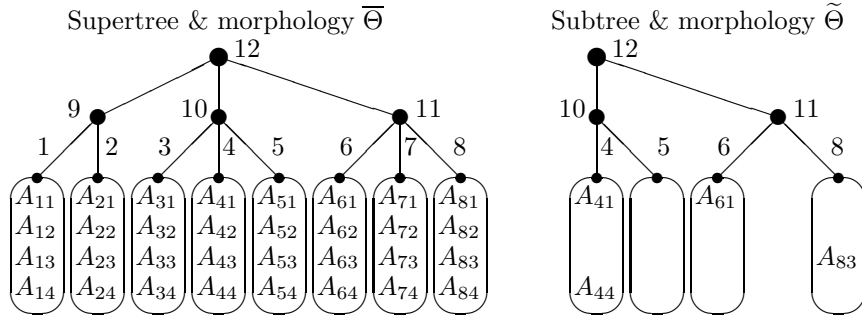

Fig. 3.13. Illustration for supertree and subtree & morphologies

Evidently, tables of compatibility estimates and their aggregation can be considered here as well.

4. PRELIMINARY ILLUSTRATIVE EXAMPLE FOR NOTEBOOK

The preliminary illustrative applied example is targeted to representation and aggregation of three initial personal computers (notebooks). The considered general morphological structure of the notebook is presented in Fig. 4.1:

0. Notebook S .

1. Hardware H :

1.1. Basic computation C :

1.1.1. Mother board B : B_1 (P67A - C43(B3) ATX Intel), B_2 (MSI 870A-G54 ATX AMD), B_3 (ASRoot P67 EXTREME 4(B3) ATX Intel);

- 1.1.2. CPU U : U_1 (Intel Pentium dual-core processor T 2330), U_2 (Celeron dual-core processor 2330), U_3 (Intel core 2 T 7200);
- 1.1.3. RAM R : R_1 (1 GB DDR A-DATA), R_2 (2 GB DDR2 KINGSTON), R_3 (2 GB DDR3 A-DATA), R_4 (2 GB DDR3 HYPER X KINGSTON);
- 1.2. Hard drive V : V_1 (100 GB HDD), V_2 (120 GB HDD), V_3 (160 GB HDD), V_4 (200 GB HDD);
- 1.3. Video/graphic cards J : J_1 (NVIDIA GeForce CTS 300M), J_2 (GT 400M Series), J_3 (ATI Radion HD 5000 M Series);
- 1.4. Communication equipment (modems) E : E_1 (Internal Modem & Antenna), E_2 (None).
2. Software W :
- 2.1. Operation system and safety Y :
- 2.1.1. OS O : O_1 (Windows XP), O_2 (Windows Vista); O_3 (Linux).
- 2.1.2. Safety software F : F_1 (Norton AntiVirus), F_2 (AntiVirus Kaspersky).
- 2.2. Information processing and Internet I :
- 2.2.1. Data support and processing D : D_1 (Microsoft Office), D_2 (None).
- 2.2.2. Internet access (browser) A : A_1 (Microsoft Internet Explorer), A_2 (Mozilla); A_3 (Microsoft Internet Explorer & Mozilla).
- 2.3. Professional software Z :
- 2.3.1. Information processing (e.g., engineering software) G : G_1 (Matlab), G_2 (LabView); G_3 (MatCad), G_4 (None);
- 2.3.2. Special software development environment P : P_1 (C++), P_2 (JAVA); P_3 (Delphi), P_4 (None);
- 2.3.3. Special editors L : L_1 (LaTex), L_2 (None);
- 2.3.4. Games Q : Q_1 (Tetris), Q_2 (Solitaire), Q_3 (Chess).

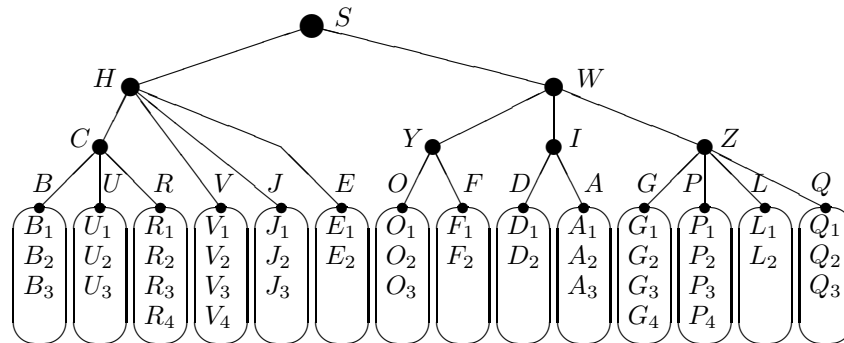

Fig. 4.1. Simplified structure of notebook

Now a simplified illustrative example for four initial solutions S_1 , S_2 , S_3 , and S_4 is examined (Fig. 4.2, Fig. 4.3, Fig. 4.4, Fig. 4.5). Here the tree-like structure is not changed and only leaf nodes are considered. Compatibility estimates between design alternatives are not considered. A framework of aggregation process for four notebooks is depicted in Fig. 4.6 (including two alternative methods to build the “system kernel”).

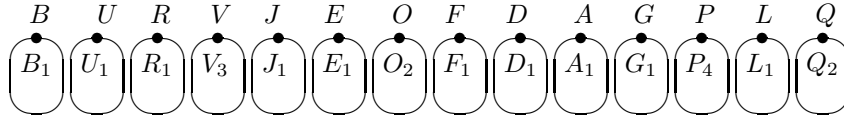

Fig. 4.2. Structure of notebook S_1

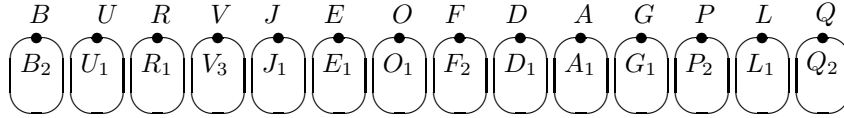

Fig. 4.3. Structure of notebook S_2

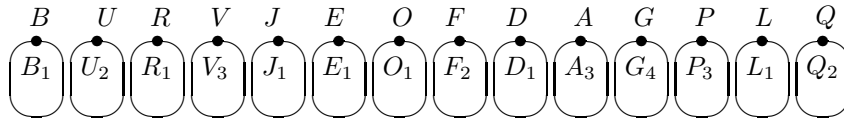

Fig. 4.4. Structure of notebook S_3

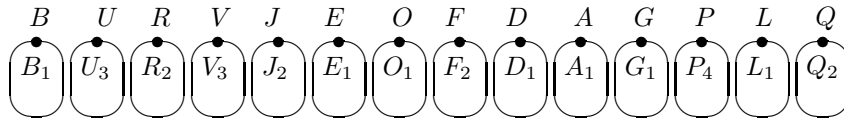

Fig. 4.5. Structure of notebook S_4

Substructure for the considered solutions \tilde{S} is depicted in Fig. 4.7, superstructure \bar{S} is depicted in Fig. 4.8. Further, let us consider “system kernel” K as an extension of substructure \tilde{S} (Fig. 4.9).

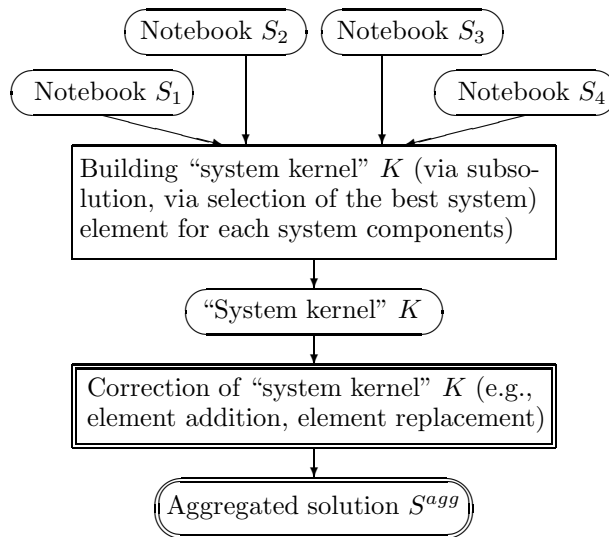
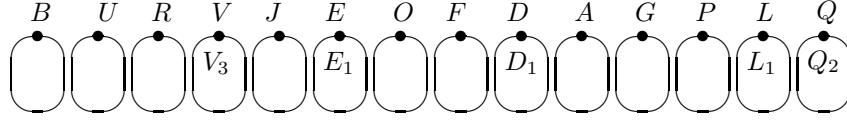
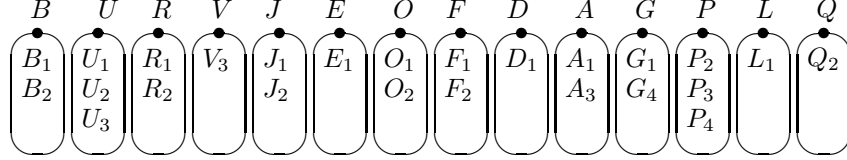
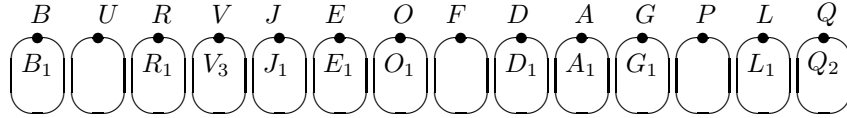

Fig. 4.6. Framework of aggregation process

Fig. 4.7. Substructure of solutions \tilde{S} Fig. 4.8. Superstructure of solutions \bar{S} Fig. 4.9. "System kernel" K

Further, the aggregation strategy as modification of "system kernel" K can be applied. A set of candidate modification operations are the following:

1. addition operations: 1.1. addition for U : U_1 or U_2 or U_3 , 1.2. addition for F : F_1 or F_2 , 1.3. addition for P : P_2 or P_3 or P_4 ;
2. correction operations: 2.1. replacement $B_1 \Rightarrow B_3$, 2.2. replacement $V_3 \Rightarrow V_4$, 2.3. replacement $A_1 \Rightarrow A_3$.

Evidently, it is reasonable to evaluate the above-mentioned modification operations (e.g., cost, profit) and to consider an optimization model. Later, corresponding optimization problems (e.g., knapsack problem, multiple choice problem) will be examined. An example of the resultant solution S^1 (modification of "system kernel" K) is shown in Fig. 4.10.

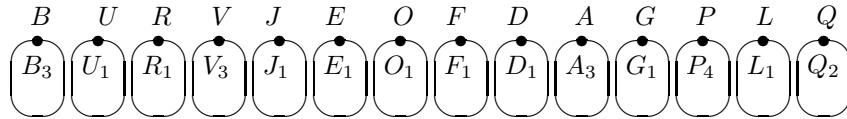
Fig. 4.10. Solution S^1 based on modification of "system kernel" K

On the the hand, building the "system kernel" can be based on multicriteria selection and/or expert judgment. Let us consider the following basic structure of "system kernel": B, U, R, V, O, F, D, G . For each system component above, it is possible to consider a selection procedure to choose the "best" system element (while taking into account elements of the initial solution or additional elements as well). For example, we can obtain the following "system kernel":

$$K^* = B_1 \star U_2 \star R_2 \star V_3 \star E_2 \star O_2 \star F_2 \star D_2 \star G_2.$$

Further, the system correction process is based on the following operations:

1. addition: A_1, P_1, L_1 ;
2. deletion: E_2 ;
3. replacement: $B_1 \Rightarrow B_3, U_2 \Rightarrow U_1, O_2 \Rightarrow O_1$.

A resultant solution S^2 is presented in Fig. 4.11.

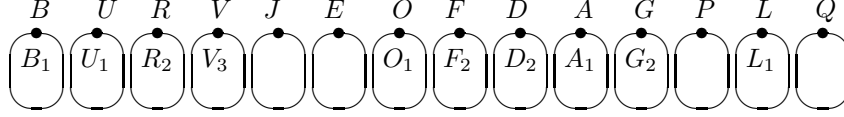

Fig. 4.11. Solution S^2

5. METRICS AND PROXIMITIES

Let us consider similarity measure between objects (in our case: sets, rankings, trees, graphs) A_1 and A_2 . It is often desired that the distance measure (function) $d(A_1, A_2)$ fulfills the following properties of a metric:

1. $d(A_1, A_2) \geq 0$ (nonnegativity),
2. $d(A_1, A_1) = 0$ (identity),
3. $d(A_1, A_2) = 0 \Leftrightarrow A \cong B$ (uniqueness),
4. $d(A_1, A_2) = d(A_2, A_1)$ (symmetry),
5. $d(A_1, A_2) + d(A_2, A_3) \geq d(A_1, A_3)$ (triangle inequality).

If the function satisfies $d(A_1, A_2) \leq 1$ it is said to be a *normalized* metric.

In many applied domains, the above-mentioned conditions are too restrictive and a more *weak* set of properties is used. As a result, $d(A_1, A_2)$ corresponds to more *weak* situations, for example: (i) quasi-metrics, (ii) proximities (without property 5, e.g., proximity for rankings in [101]).

Metrics/proximities play the basic role in many important problems over structures, for example: approximation, modification, aggregation. There exist three basic approaches to similarity/proximity of objects/structures:

- (1) traditional metrics/distances (e.g., [22], [47], [60], [61], [128]);
- (2) minimum cost transformation of an object/structure into another one (edit distance) (e.g., [20], [25], [68], [97], [127], [148], [158], [171]); and
- (3) maximum common substructure or maximum agreement substructure (e.g., [2], [3], [25], [26], [104], [106], [136], [161]).

5.1. Metric/Proximity for Sets. Let $A = \{1, \dots, i, \dots, n\}$ be a set of elements. Let us consider ... for two subsets $A^1 \subseteq A$ and $A^2 \subseteq A$. The most simple case of metric by elements (i.e., distance) is the following: (while taking into account assumption $|A^1 \cup A^2| \neq 0$):

$$\rho_e(A^1, A^2) = 1 - \frac{|A^1 \cap A^2|}{|A^1 \cup A^2|}.$$

Further, let $w_i \in (0, 1]$ be a weight of element $i \in A$. Then proximity (i.e., metric, distance) by element weights is as follows (while taking into account assumption $\sum_{i \in (A^1 \cup A^2)} w_i \neq 0$):

$$\rho_w(A^1, A^2) = 1 - \frac{\sum_{i \in (A^1 \cap A^2)} w_i}{\sum_{i \in (A^1 \cup A^2)} w_i}.$$

Now let us consider a simple numerical example (Table 5.1) that involves initial set $A = \{1, 2, 3, 4, 5, 6, 7, 8\}$ and two subsets: $A^1 = \{1, 2, 4, 5\}$ and $A^2 = \{1, 2, 3, 4, 5, 6, 7\}$. Elements weights are the following: 0.5, 0.6, 0.4, 1.0, 0.7, 0.2, 0.1, and 1.0. The resultant proximities are: $\rho_e(A^1, A^2) = 1 - \frac{3}{7} = 0.571$ and $\rho_w(A^1, A^2) = 1 - \frac{1.8}{3.5} = 0.496$.

Table 5.1. Illustrative numerical example

| i | w_i | A | A^1 | A^2 | $A^1 \cup A^2$ | $A^1 \cap A^2$ |
|-----|-------|-----|-------|-------|----------------|----------------|
| 1 | 0.5 | * | * | * | * | * |
| 2 | 0.6 | * | * | * | * | * |
| 3 | 0.4 | * | | * | * | |
| 4 | 1.0 | * | * | | * | |
| 5 | 0.7 | * | * | * | * | * |
| 6 | 0.2 | * | | | * | |
| 7 | 0.1 | * | | * | * | |
| 8 | 1.0 | * | | | | |

In the case of vector weights $\bar{w}_i = (w_i^1, \dots, w_i^\xi, \dots, w_i^r)$, a simplified vector distance (or proximity) is:

$$\rho_{\bar{w}}(A^1, A^2) = (\rho_{\bar{w}}^1(A^1, A^2), \dots, \rho_{\bar{w}}^\xi(A^1, A^2), \dots, \rho_{\bar{w}}^r(A^1, A^2)) =$$

$$(1 - \frac{\sum_{i \in (A^1 \cap A^2)} w_i^1}{\sum_{i \in (A^1 \cup A^2)} w_i^1}, \dots, 1 - \frac{\sum_{i \in (A^1 \cap A^2)} w_i^\xi}{\sum_{i \in (A^1 \cup A^2)} w_i^\xi}, \dots, 1 - \frac{\sum_{i \in (A^1 \cap A^2)} w_i^r}{\sum_{i \in (A^1 \cup A^2)} w_i^r}).$$

5.2. Proximity for Strings/Sequences. This problem of proximity analysis is important in code design, genom studies, information processing, and mathematical linguistics. Generally, three kinds of proximity for strings/ sequences are examined: (1) common part of initial strings as substring, superstring (e.g., [7], [6], [40], [65], [78], [79], [153]), (2) median string (e.g., [94], [130]), and (3) editing distance (a length/cost of an transformation/editing) (e.g., [6], [68], [97], [137], [160]).

Here basic research issues are targeted to the following: (a) complexity analysis (e.g., [153]); (b) design of polynomial algorithms (e.g., [68], [79]); and (c) design of approximation algorithms (e.g., [78]).

5.3. Proximity for Rankings. Here several types of metrics/proximities can be used, for example: 1. Kendall-Tau distance [90]; 2. distances for partial rankings (e.g., [11], [51]); 3. vector-like proximity ([98], [100], [101]). Further, Kendall-Tau distance and vector-like proximity are briefly described (the description is based on material from [101]).

Let $\|g_{ij}\|, (i, j \in A)$ be an adjacency matrix for graph G :

$$g_{ij} = \begin{cases} 1, & \text{if } i \succ j, \\ 0, & \text{if } i \sim j, \\ -1, & \text{if } i \prec j. \end{cases}$$

Kendall-Tau distance (metric) for graphs G^1 and G^2 is the following:

$$\rho_K(G^1, G^2) = \sum_{i < j} |g_{ij}^1 - g_{ij}^2|,$$

where g_{ij}^1, g_{ij}^2 are elements of adjacency matrices of graphs G^1 and G^2 accordingly.

Basic definitions for vector-like proximity are the following ([98], [100], [101]). Let $\Psi(S)$ be a set of all layered structures on A .

Definition 5.1. Let us call the first order error $\forall i \in A$, and the second order error $\forall (i, j) \in \{A \star A | i \neq j\}$ $\forall S, Q \in \Psi(S)$ as follows:

$$\delta_i^\pi(S, Q) = \pi_i(S) - \pi_i(Q),$$

$$\delta_{i,j}^\pi(S, Q) = \pi_i(S) - \pi_j(S) - (\pi_i(Q) - \pi_j(Q)),$$

where $\pi_i(S) = l \forall i \in A(l)$ in S . Thus, for an estimate of a discordance between the structures $S, Q \in \Psi(S)$ with respect to i and (i, j) , an integer-valued scale with the following ranges is obtained:

- (i) $-(m-1) \leq r \leq m-1$ for $\delta_i^\pi(S, Q)$, and
- (ii) $-2(m-1) \leq r \leq 2(m-1)$ for $\delta_{i,j}^\pi(S, Q)$.

Definition 5.2. Let

$$x(S, Q) = (x^{-(m-1)}, \dots, x^{-1}, x^1, \dots, x^{m-1}),$$

$$y(S, Q) = (y^{-2(m-1)}, \dots, y^{-1}, y^1, \dots, y^{2(m-1)}),$$

be vectors of an error (proximity) $\forall S, Q \in \Psi(S)$ with respect to components i (1st order), and the pairs (i, j) (2nd order). The components of above-mentioned vectors are defined as follows:

$$x^r = |\{i \in A | \delta_i^\pi(S, Q) = r\}|/n,$$

$$y^r = 2|\{(i, j) \in \{A \star A | i \neq j\} | \delta_{i,j}^\pi(S, Q) = r\}|/(n(n-1)).$$

Now denote a set of arguments for the components of vectors x and y as follows: $\Omega = \{-k, \dots, k\}$, negative values as Ω^- , and positive ones as Ω^+ . In addition, we will use the vectors x with aggregate components of the following type (similarly, for y):

$$x^{k_1, k_2} = \sum_{r=k_1}^{k_2} x^r, x^{\leq -k} = \sum_{r=-(m-1)}^{-k} x^r, x^{\geq k} = \sum_{r=k}^{m-1} x^r, k > 0, x^{|r|} = x^r + x^{-r}.$$

Definition 5.3. Let $|x(S, Q)| = \sum_{r \in \Omega} x^r$, $|y(S, Q)| = \sum_{r \in \Omega} y^r$ be modules of the vectors.

Vector x will be used as a basic one.

Definition 5.4. We will call vectors truncated ones if

- (1) the part of terminal components is rejected, e.g.,

$$x(S, Q) = (x^{-k_1}, x^{-(k_1-1)}, \dots, x^{-1}, x^1, \dots, x^{k_2-1}, x^{k_2}),$$

and one or both of following conditions are satisfied: $k_1 < m-1$, $k_2 < m-1$;

- (2) aggregate components are used as follows:

$$x(S, Q) = (x^{\leq k_1}, \dots, x^{k_a-1}, x^{k_a, k_b}, x^{k_b+1}, \dots, x^{\geq k_2}),$$

$$x(S, Q) = (x^{|1|}, \dots, x^{|r|}, \dots, x^{|k|}).$$

Definition 5.5. Let us call vector x (y):

- (a) the two-sided one, if $|\Omega^+| \neq 0$ and $|\Omega^-| = 0$;
- (b) the one-sided one, if $|\Omega^+| = 0$ or $|\Omega^-| = 0$;
- (c) the symmetrical one, if $-r \in \Omega^-$ exists $\forall r \in \Omega^+$, and vice versa;
- (d) the modular one, if it is defined with respect of definition 5.4 (5.3).

Moreover, a pair of linear orders on the components of vectors x and y (definition 5.2) is obtained: *component* $1(-1) \prec \dots \prec$ *component* $k(-k)$.

Definition 5.6. $x_1(S, Q) \succeq x_2(S, Q)$, $\Omega(x_1) = \Omega(x_2)$, $\forall S, Q \in \Psi(S)$, if any decreasing of weak components x_1 in the comparison with x_2 is compensated by corresponding increasing of it's 'strong' components ($r, p \in \Omega^+$ or $-r, -p \in \Omega^-$):

$$\sum_{r \geq u}^r x_1^r - \sum_{r \geq u}^r x_2^r \geq 0, \forall u \in \Omega^+ (\forall -u \in \Omega^-, -r \leq -u).$$

Now let us consider an illustrative numerical example:

- (a) initial set $A = \{1, 2, 3, 4, 5, 6, 7, 8, 9\}$,
 - (b) ranking $S^1 = \{A_1^1 = \{2, 4\}, A_2^1 = \{9\}, A_3^1 = \{1, 3, 7\}, A_4^1 = \{5, 6, 8\}\}$ and
 - (c) ranking $S^2 = \{A_1^2 = \{7, 9\}, A_2^2 = \{1, 3\}, A_3^2 = \{2, 5, 8\}, A_4^2 = \{4, 6\}\}$.
- Corresponding adjacency matrices are as follows:

$$|g_{ij}(S^1)| = \begin{pmatrix} . & -1 & 0 & -1 & 1 & 1 & 0 & 1 & -1 \\ 1 & . & 1 & 0 & 1 & 1 & 1 & 1 & 1 \\ 0 & -1 & . & -1 & 1 & 1 & 0 & 1 & -1 \\ 1 & 0 & 1 & . & 1 & 1 & 1 & 1 & 1 \\ -1 & -1 & -1 & -1 & . & 0 & -1 & 0 & -1 \\ -1 & -1 & -1 & -1 & 0 & . & -1 & 0 & -1 \\ 0 & -1 & 0 & -1 & 1 & 1 & . & 1 & -1 \\ -1 & -1 & -1 & -1 & 0 & 0 & -1 & . & -1 \\ 1 & -1 & 1 & -1 & 1 & 1 & 1 & 1 & . \end{pmatrix}$$

$$|g_{ij}(S^2)| = \begin{pmatrix} . & 1 & 0 & 1 & 1 & 1 & -1 & 1 & -1 \\ -1 & . & -1 & 1 & 0 & 1 & -1 & 0 & -1 \\ 0 & 1 & . & 1 & 1 & 1 & -1 & 1 & -1 \\ -1 & -1 & -1 & . & -1 & 0 & -1 & -1 & -1 \\ -1 & 0 & -1 & 1 & . & 1 & -1 & 0 & -1 \\ -1 & -1 & -1 & 0 & -1 & . & -1 & -1 & -1 \\ 1 & 1 & 1 & 1 & 1 & 1 & . & 1 & 0 \\ -1 & 0 & -1 & 1 & 0 & 1 & -1 & . & -1 \\ 1 & 1 & 1 & 1 & 1 & 1 & 0 & 1 & . \end{pmatrix}$$

Now it is very easy to calculate Kendall-Tau distance between S^1 and S^2 :

$$\rho_K(S^1, S^2) = 31.$$

Vector-like proximities allow more prominent description of dissimilarity between structures S^1 and S^2 :

$$\pi(S^1) = (\pi_1(S^1), \dots, \pi_i(S^1), \dots, \pi_4(S^1) = (3, 1, 3, 1, 4, 4, 3, 4, 2),$$

$$\pi(S^2) = (\pi_1(S^2), \dots, \pi_i(S^2), \dots, \pi_4(S^2) = (2, 3, 2, 4, 3, 4, 1, 3, 1),$$

$$\delta_i^\pi(S^1, S^2) = (1, -2, 1, -3, 1, 0, 2, 1, 1),$$

$$\delta_{ij}^{\pi}(S^1, S^2) = \begin{pmatrix} . & 3 & 0 & 4 & 0 & 1 & -1 & 0 & 0 \\ -3 & . & -3 & -1 & -3 & -2 & -4 & -3 & -3 \\ 0 & 3 & . & -4 & 0 & 1 & 1 & 0 & 0 \\ -4 & 1 & 4 & . & -4 & -3 & -5 & -4 & -4 \\ 0 & 3 & 0 & 4 & . & 1 & -1 & 0 & 0 \\ -1 & -2 & -1 & 3 & -1 & . & -1 & -1 & -1 \\ 1 & 4 & -1 & 5 & 1 & 1 & . & 1 & 1 \\ 0 & 3 & 0 & 4 & 0 & 1 & -1 & . & 0 \\ 0 & 3 & 0 & 4 & 0 & 1 & -1 & 0 & . \end{pmatrix}$$

$$x(S^1, S^2) = (x^{-3}, x^{-2}, x^{-1}, x^1, x^2, x^3) = (1, 1, 0, 5, 1, 0),$$

$$y(S^1, S^2) = (y^{-6}, y^{-5}, y^{-4}, y^{-3}, y^{-2}, y^{-1}, y^1, y^2, y^3, y^4, y^5, y^6) =$$

$$(0, 1, 5, 5, 1, 6, 6, 0, 1, 1, 0, 0).$$

Note, the coefficients $\frac{1}{n}$ and $\frac{2}{n(n-1)}$ were not used in x and y .

5.4. Proximity for Trees. The following approaches to proximity (similarity/dissimilarity) of trees are considered (e.g., [33], [44], [2], [3], [52], [75], [141], [149], [156], [157]):

(i) metrics (distance) (e.g., [33], [44], [149], [157]) including some special kinds of distances: alignment distance [80], isolated subtree distance [150], top-down distance ([141], [167]), and bottom-up distance [156];

(ii) tree edit distance (e.g., [31], [140], [148], [154], [168], [169], [170]); and

(iii) common subtree, median tree or tree agreement, consensus (e.g., [2], [3], [52], [54], [75], [76], [142], [146], [162]).

It is reasonable to note, trees are ordered structures. Thus, efficient (polynomial) computing algorithms have been suggested for building metrics/proximities of some kinds of trees (e.g., [49], [154], [155], [156]).

Further, our simplified version of two-component proximity for rooted labelled trees is considered and used. Let $T' = (A', E')$ and $T'' = (A'', E'')$ be two rooted labelled trees (the root is the same in both trees) where A' and A'' are the vertices, E' and E'' are the arcs. Let us consider *dominance parameter* $\forall(a, b) \in (E' \cap E'')$. The following three *dominance cases* can be examined: (i) $a \rightarrow b$ (a dominates b , i.e., $a \succ b$), (ii) $b \rightarrow a$ (b dominates a , i.e., $a \prec b$), and (iii) a and b are independent. Then *dominance parameter* is:

$$d_{(a,b) \in (E' \cap E'')} = \begin{cases} d^1, & \text{if } a \rightarrow b, \\ d^2, & \text{if } b \rightarrow a, \\ d^3, & \text{if } a, b \text{ are independent.} \end{cases}$$

As a result, *change parameter* $\forall(a, b) \in (E' \cap E'')$ can be define as the following:

$$P_{(a,b) \in (E' \cap E'')} = \begin{cases} 0, & \text{if } d_{(a,b) \in (E' \cap E'')} \text{ is not changed,} \\ 1, & \text{if } d_{(a,b) \in (E' \cap E'')} \text{ is changed.} \end{cases}$$

Finally, the proximity of two trees is:

$$\bar{\rho}(T', T'') = (\rho(A', A''), \rho(E', E'')),$$

where

$$\rho_e(A', A'') = 1 - \frac{|A' \cap A''|}{|A' \cup A''|},$$

$$\rho(E', E'') = \frac{\sum_{(a,b) \in (E' \cap E'')} P_{(a,b) \in (E' \cap E'')}}{|(E' \cap E'')|}.$$

Table 5.3. *Dominance factor for T''*

| | 1 | 2 | 3 | 4 | 5 | 6 | 7 | 8 |
|---|---|-------|-------|-------|------------------|------------------|-------|------------------|
| 1 | * | d^1 | d^1 | d^1 | d^1 | d^1 | d^1 | d^1 |
| 2 | — | * | d^3 | d^1 | $\overline{d^3}$ | $\overline{d^1}$ | d^3 | d^3 |
| 3 | — | — | * | d^3 | d^3 | $\overline{d^3}$ | d^1 | $\overline{d^2}$ |
| 4 | — | — | — | * | d^3 | d^3 | d^3 | d^3 |
| 5 | — | — | — | — | * | d^3 | d^3 | $\overline{d^2}$ |
| 6 | — | — | — | — | — | * | d^3 | d^3 |
| 7 | — | — | — | — | — | — | * | $\overline{d^2}$ |
| 8 | — | — | — | — | — | — | — | * |

Example 5.3: Trees T' and T'' are presented in Fig. 5.4: $A' = \{1, 2, 3, 4, 5, 6, 7, 8\}$, $A'' = \{1, 2, 3, 6, 8, 9, 10\}$, and $A' \cap A'' = \{1, 2, 3, 6, 8\}$. The proximity for vertex sets is: $\rho(A', A'') = \frac{1}{2}$.

Table 5.4 and table 5.5 contain corresponding *dominance factors* for $A' \cap A''$ in T' and in T'' (changes are depicted via 'ovals'). Finally, the general proximity is: $\bar{\rho}(T', T'') = (\frac{1}{2}, \frac{1}{5})$.

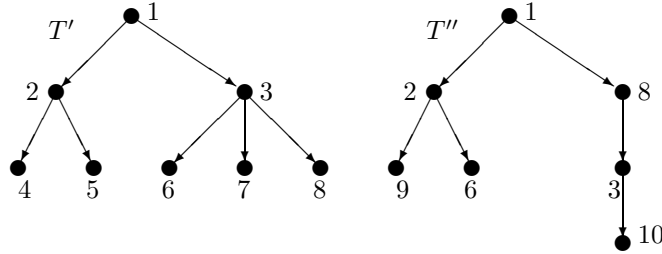

Fig. 5.4. Tree for example 3

 Table 5.4. *Dominance factor for T'*

| | 1 | 2 | 3 | 6 | 8 |
|---|---|-------|-------|-------|-------|
| 1 | * | d^1 | d^1 | d^1 | d^1 |
| 2 | — | * | d^3 | d^3 | d^3 |
| 3 | — | — | * | d^1 | d^1 |
| 6 | — | — | — | * | d^3 |
| 8 | — | — | — | — | * |

 Table 5.5. *Dominance factor for T''*

| | 1 | 2 | 3 | 6 | 8 |
|---|---|-------|-------|------------------|------------------|
| 1 | * | d^1 | d^1 | d^1 | d^1 |
| 2 | — | * | d^3 | $\overline{d^3}$ | d^3 |
| 3 | — | — | * | d^1 | $\overline{d^1}$ |
| 6 | — | — | — | * | d^3 |
| 8 | — | — | — | — | * |

5.5. Proximity for Morphological Structures. Generally, morphological structures are composite ones and it is reasonable to consider the corresponding their proximity as vector-like proximity. General structure (Λ) consists of the following parts: (i) tree-like system model \mathbf{T} , (ii) set of leaf nodes \mathbf{P} , (iii) sets of DAs for each leaf node \mathbf{D} , (iv) DAs rankings (i.e., ordinal priorities) \mathbf{R} , and (v) compatibility estimates between DAs \mathbf{I} . Thus, the vector-like proximity for two morphological structures $\Lambda^\alpha, \Lambda^\beta$ can be examined as follows:

$$\bar{\rho}(\Lambda^\alpha, \Lambda^\beta) = (\rho^t(\mathbf{T}^\alpha, \mathbf{T}^\beta), \rho^t(\mathbf{P}^\alpha, \mathbf{P}^\beta), \rho^t(\mathbf{D}^\alpha, \mathbf{D}^\beta), \rho^t(\mathbf{R}^\alpha, \mathbf{R}^\beta), \rho^t(\mathbf{I}^\alpha, \mathbf{I}^\beta)).$$

Let us consider a simplified example: structure (Λ) is examined as a composition of two parts: (a) tree $T = (A, E)$ (i.e., set of vertices and set of arcs), (b) rankings for each leaf node i ($\bigcup_i R_i$). In our case, the proximity of two morphological structures is:

$$\bar{\rho}(\Lambda', \Lambda'') = (\rho(A', A''), \rho(E', E''), \rho_r(\Lambda', \Lambda'')).$$

Here it is assumed sets of design alternatives for leaf vertices are not changed and tables of compatibility estimates are not considered. An example illustrate the approach.

Example 5.4: Trees T' and T'' are presented in Fig. 5.5: $A' = \{1, 2, 3, 4, 5, 6, 7, 8\}$, $A'' = \{1, 2, 3, 4, 5, 6, 7, 9\}$, and $A' \cup A'' = \{1, 2, 3, 4, 5, 6, 7\}$. The proximity for vertex sets is: $\rho(A', A'') = \frac{2}{9}$. Table 5.6 and Table 5.7 contain corresponding *dominance factors* for $A' \cup A''$ in T' and in T'' (changes are depicted via 'ovals'). Finally, the proximity for trees is: $\bar{\rho}(T', T'') = (\frac{2}{9}, \frac{2}{21})$.

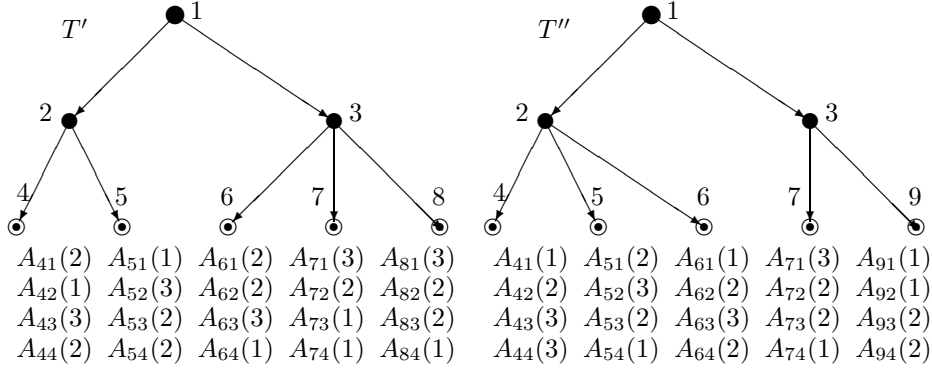

Fig. 5.5. Trees with morphology for example 4

Here the comparison process for rankings is based on rankings for common leaf vertices: $L(T', T'') = \{4, 5, 6, 7\}$. Thus, for each vertex above it is possible to use a metric/proximity. In our case (Fig. 14), the following metric (normalized Kendall-Tau distance) values are obtained: vertex 4: $\delta_4(\Lambda', \Lambda'') = \frac{1}{3}$, vertex 5: $\delta_5(\Lambda', \Lambda'') = \frac{1}{2}$, vertex 6: $\delta_6(\Lambda', \Lambda'') = \frac{1}{3}$, and vertex 7: $\delta_7(\Lambda', \Lambda'') = \frac{1}{6}$. The resultant general proximity for rankings can be computer as an average value:

$$\rho_r(\Lambda', \Lambda'') = \frac{\sum_{i \in L(T', T'')} \delta_i(\Lambda', \Lambda'')}{|L(T', T'')|} = 0.33.$$

Finally, the general proximity is:

$$\bar{\rho}(\Lambda', \Lambda'') = (\rho(A', A''), \rho(E', E''), \rho_r(\Lambda, \Lambda'')) = (0.22, 0.1, 0.33).$$

Note, proximity of compatibility estimates can be added into the proximity vector above as well.

Table 5.6. *Dominance factor for T'*

| | 1 | 2 | 3 | 4 | 5 | 6 | 7 |
|---|---|-------|-------|-------|-------|-------|-------|
| 1 | * | d^1 | d^1 | d^1 | d^1 | d^1 | d^1 |
| 2 | — | * | d^3 | d^1 | d^1 | d^2 | d^2 |
| 3 | — | — | * | d^3 | d^3 | d^1 | d^1 |
| 4 | — | — | — | * | d^3 | d^3 | d^3 |
| 5 | — | — | — | — | * | d^3 | d^3 |
| 6 | — | — | — | — | — | * | d^3 |
| 7 | — | — | — | — | — | — | * |

 Table 5.7. *Dominance factor for T''*

| | 1 | 2 | 3 | 4 | 5 | 6 | 7 |
|---|---|-------|-------|-------|-------|------------------|-------|
| 1 | * | d^1 | d^1 | d^1 | d^1 | d^1 | d^1 |
| 2 | — | * | d^3 | d^1 | d^1 | $\overline{d^1}$ | d^2 |
| 3 | — | — | * | d^3 | d^3 | $\overline{d^3}$ | d^1 |
| 4 | — | — | — | * | d^3 | d^3 | d^3 |
| 5 | — | — | — | — | * | d^3 | d^3 |
| 6 | — | — | — | — | — | * | d^3 |
| 7 | — | — | — | — | — | — | * |

6. UNDERLYING PROBLEMS

6.1. Multicriteria Ranking. Let $A = \{A_1, \dots, A_j, \dots, A_n\}$ be a set of alternatives and $C = \{C_1, \dots, C_p, \dots, C_m\}$ be a set of criteria. An estimate vector $z_j = \{z_{j1}, \dots, z_{jp}, \dots, z_{jm}\}$ as a result of an assessment upon criteria above is given for each alternative A_j . In addition, criteria weights $\{\mu_p\}$ are used as well. The problem consists in comparison of the alternatives and forming for each alternative an ordinal quality estimate (priority). This problem belongs to a class of ill-structured problems by classification of H. Simon [144]. In the paper, a modification of out-ranking technique Electre [139] has been used (the modification was suggested in [115]).

6.2. Knapsack Problem. The basic problem is (e.g., [57], [86]):

$$\max \sum_{i=1}^m c_i x_i$$

$$s.t. \sum_{i=1}^m a_i x_i \leq b, \quad x_i \in \{0, 1\}, \quad i = \overline{1, m}$$

and additional resource constraints $\sum_{i=1}^m a_{i,k} x_i \leq b_k$; $k = \overline{1, l}$; where $x_i = 1$ if item i is selected, c_i is a value (“utility”) for item i , and a_i is a weight (or required resource). Often nonnegative coefficients are assumed. The problem is NP-hard [57] and can be solved by the following methods: (i) enumerative methods (e.g., Branch-and-Bound, dynamic programming), (ii) approximate schemes with a limited relative error (e.g., [86]), and (iii) heuristics.

A basic version of knapsack problem with minimization of the objective function is:

$$\min \sum_{i=1}^m c_i x_i$$

$$s.t. \sum_{i=1}^m a_i x_i \geq b, \quad x_i \in \{0, 1\}, \quad i = \overline{1, m}.$$

For multiple criteria statements it is reasonable to search for Pareto-efficient solutions. Mainly, heuristics, evolutionary algorithms, dynamic programming, and local search methods are applied to multicriteria knapsack problems (e.g., [15], [48], [56], [92], [124], [172]). A recent survey on multicriteria knapsack problem is contained in [124].

6.3. Knapsack Problem and Compatibility. Now let us consider item dependence in knapsack problem [101]. Here the following is considered: binary compatibility of items as a symmetric binary relation (i.e., the selected subset has to contain only compatible items, 1 corresponds to compatibility of items and 0 correspond to incompatible case). Thus, the consideration of compatibility for knapsack problem leads to searching for a clique (“profit clique”) with the following properties:

- (i) maximum total profit of the selected items: $\max \sum_{i=1}^n c_i$,
- (ii) restricted total weight of the selected items: $\sum_{i=1}^n a_i \leq b$.

Table 6.1 and Table 6.2 contain descriptions of numerical examples for the following problems (this example is a modification of the example from [101]):

Table 6.1. Initial data and results

| i | c_i | a_i | Knapsack problem | “Profit clique” | Maximal clique |
|-----|-------|-------|------------------|-----------------|----------------|
| 1 | 5 | 2 | * | * | * |
| 2 | 12 | 5 | * | * | * |
| 3 | 4 | 2 | * | | |
| 4 | 2 | 1 | * | * | * |
| 5 | 3 | 2 | * | | |
| 6 | 4 | 3 | | * | * |
| 7 | 1 | 2 | | | * |
| 8 | 1 | 3 | | | * |
| C | | | 26 | 23 | |
| A | | | 12 | 11 | |
| M | | | 5 | 4 | 6 |

- (a) basic knapsack problem,
- (b) “profit clique” (i.e., knapsack problem and compatibility of the selected items), and
- (c) maximal clique (maximizing the number of selected compatible items).

The following notations are used:

- (1) M is the number of items in a solution (i.e., the number of the selected items);
- (2) $b = 13$ is the right-side constraint (additional constraints are not applied);
- (3) symbol $*$ corresponds to a selected item; and
- (4) characteristics the solution are: $C = \sum_{i=1}^m c_i x_i$, $A = \sum_{i=1}^m a_i x_i$.

Clearly, the considered problems are NP-hard. Thus, heuristics are used. Multicriteria versions of “profit clique” problem can be examined and used as well.

Table 6.2. Compatibility

| i | 1 | 2 | 3 | 4 | 5 | 6 | 7 | 8 |
|-----|---|---|---|---|---|---|---|---|
| 1 | . | 1 | 0 | 1 | 0 | 1 | 1 | 1 |
| 2 | 1 | . | 0 | 1 | 1 | 1 | 1 | 1 |
| 3 | 1 | 0 | . | 1 | 1 | 1 | 1 | 1 |
| 4 | 1 | 1 | 1 | . | 1 | 1 | 1 | 1 |
| 5 | 0 | 0 | 1 | 0 | . | 1 | 1 | 0 |
| 6 | 1 | 1 | 0 | 1 | 0 | . | 1 | 1 |
| 7 | 1 | 1 | 1 | 1 | 1 | 1 | . | 1 |
| 8 | 1 | 1 | 0 | 1 | 0 | 1 | 1 | . |

6.4. Multiple Choice Knapsack Problem. In the case of a multiple choice problem, the items (e.g., actions) are divided into groups and we select elements from each group while taking into account a total resource constraint (or constraints) (e.g., [57], [73], [86], [132]):

$$\begin{aligned} & \max \sum_{i=1}^m \sum_{j=1}^{q_i} c_{ij} x_{ij} \\ \text{s.t. } & \sum_{i=1}^m \sum_{j=1}^{q_i} a_{ij} x_{ij} \leq b, \quad \sum_{j=1}^{q_i} x_{ij} = 1, \quad i = \overline{1, m}, \quad x_{ij} \in \{0, 1\}. \end{aligned}$$

In the case of multicriteria description, each element (i.e., (i, j)) has a vector profit: $\overline{c}_{i,j} = (c_{i,j}^1, \dots, c_{i,j}^\xi, \dots, c_{i,j}^r)$. A version of multicriteria multiple choice problem was presented in ([110], [118], [120]):

$$\begin{aligned} & \max \sum_{i=1}^m \sum_{j=1}^{q_i} \overline{c}_{i,j}^\xi x_{ij}, \quad \forall \xi = \overline{1, r} \\ \text{s.t. } & \sum_{i=1}^m \sum_{j=1}^{q_i} a_{ij} x_{ij} \leq b, \quad \sum_{j=1}^{q_i} x_{ij} = 1, \quad i = \overline{1, m}, \quad x_{ij} \in \{0, 1\}. \end{aligned}$$

Evidently, in this case it is reasonable to search for Pareto-efficient solutions (by the vector objective function above). Here the following solving schemes can be used ([118], [120]): (i) dynamic programming, (ii) heuristic based on preliminary multicriteria ranking of elements to get their priorities and step-by-step packing the knapsack (i.e., greedy approach), (iii) multicriteria ranking of elements to get their ordinal priorities and usage of approximate solving scheme (as for knapsack problem) based on discrete space of system excellence (i.e., quality lattice as in HMMD [101]). In the article, greedy heuristic above is used later.

6.5. Morphological Design. A brief description of HMMD is a typical one as follows (e.g., [101], [105], [106], [110]). The composite (modular, decomposable) system under examination consists of the components and their interconnections or compatibilities. Basic assumptions of HMMD are the following: (a) a tree-like structure of the system; (b) a composite estimate for system quality that integrates components (subsystems, parts) qualities and qualities of interconnections (hereinafter referred as ‘IC’) across subsystems; (c) monotonic criteria for the system and its components; and (d) quality of system components and IC are evaluated on the basis of coordinated ordinal scales. The designations are: (1) design alternatives

(DAs) for nodes of the model; (2) priorities of DAs ($r = \overline{1, k}$; 1 corresponds to the best level); (3) ordinal compatibility estimates for each pair of DAs ($w = \overline{0, l}$; l corresponds to the best level). The basic phases of HMMD are: 1. design of the tree-like system model (a preliminary phase); 2. generating DAs for model's leaf nodes; 3. hierarchical selection and composing of DAs into composite DAs for the corresponding higher level of the system hierarchy (morphological clique problem); and 4. analysis and improvement of the resultant composite DAs (decisions). Let S be a system consisting of m parts (components): $P(1), \dots, P(i), \dots, P(m)$. A set of design alternatives is generated for each system part above. The problem is:

Find a composite design alternative $S = S(1) \star \dots \star S(i) \star \dots \star S(m)$ of DAs (one representative design alternative $S(i)$ for each system component/part $P(i)$, $i = \overline{1, m}$) with non-zero IC estimates between design alternatives.

A discrete space of the system excellence on the basis of the following vector is used: $N(S) = (w(S); n(S))$, where $w(S)$ is the minimum of pairwise compatibility between DAs which correspond to different system components (i.e., $\forall P_{j_1}$ and P_{j_2} , $1 \leq j_1 \neq j_2 \leq m$) in S , $n(S) = (n_1, \dots, n_r, \dots, n_k)$, where n_r is the number of DAs of the r th quality in S ($\sum_{r=1}^k n_r = m$). As a result, we search for composite system decisions which are nondominated by $N(S)$. Here an enumerative solving scheme (e.g., dynamic programming) is used (usually $m \leq 6$).

Fig. 6.1 and Fig. 6.2 illustrate the composition problem (by a numerical example for a system consisting of three parts $S = X \star Y \star Z$). Priorities of DAs are shown in Fig. 6.1 in parentheses and are depicted in Fig. 6.2; compatibility estimates are pointed out in Fig. 6.2). In the example, the resultant composite decision is (Fig. 6.1, Fig. 6.2): $S_1 = X_4 \star Y_2 \star Z_2$, $N(S_1) = (2; 1, 1, 1)$.

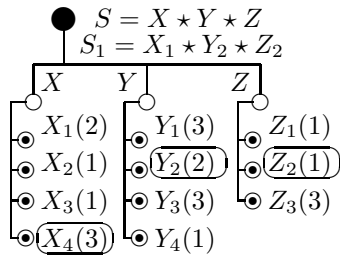

Fig. 6.1. Example of composition

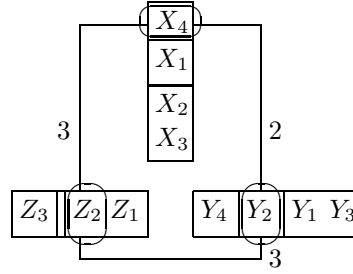

Fig. 6.2. Concentric presentation

7. MEDIAN/CONSENSUS PROBLEMS AND AGGREGATION PROBLEMS

7.1. Sets. Evidently, sets are the basic structures. Let us consider the case of m sets. The extended median/consensus for m sets $\{A_1, \dots, A_i, \dots, A_m\}$ is the following. Analogically, $\forall e \in \bigcup_{i=1}^m A_i$ two attributes are examined: “profit”/“utility” $c_e \geq 0$, required resource $b_e \geq 0$. Let $R_{\{A_i\}} = \tilde{S}_{\{A_i\}} \subseteq \bigcap_{i=1}^m A_i$ (or $R_{\{A_i\}} = M_{\{A_i\}}$) be a basic “consensus” set and $\sum_{e \in R_{AB}} b_e \leq b$, where b is a total resource. The problem of “extended median/consensus” is:

$$\max \sum_{e \in W \subseteq ((\bigcup_{i=1}^m A_i) \setminus R_{\{A_i\}})} c_e$$

$$s.t. \quad \sum_{e \in W \subseteq ((\bigcup_{i=1}^m A_i) \setminus R_{\{A_i\}})} b_e \leq b.$$

This model corresponds to basic knapsack problem.

Further, aggregation problems for sets will be examined. First, let us consider two-set case for sets A, B . Here the following proximity/metric is used: $\rho(A, B) \geq 0, \rho(A, B) = \rho(B, A)$. For example, the following simple metric can be used: $\rho(A, B) = |A \cap B| / |A \cup B|$.

A median-like subset (median-like consensus model by Kendall etc. [90]) is:

$$M_{AB} = \arg \min_{\{M\}} (\rho(M, A) + \rho(M, B)).$$

The case of the extended median/consensus for two sets A, B is similar. Here two attributes are examined $\forall e \in (A \cup B)$: “profit”/“utility” $c_e \geq 0$, required resource $b_e \geq 0$. Let $R_{AB} = \tilde{S}_{AB}$ (or $R_{AB} = M_{AB}$) be a basic “consensus” set and $\sum_{e \in R_{AB}} b_e \leq b$, where b is a total resource. The problem of building the “extended median/consensus” is:

$$\begin{aligned} & \max \quad \sum_{e \in W \subseteq ((A \cup B) \setminus R_{AB})} c_e \\ s.t. \quad & \sum_{e \in W \subseteq ((A \cup B) \setminus R_{AB})} b_e \leq b. \end{aligned}$$

This model corresponds to basic knapsack problem.

Now let us consider the multi-set case. The extended median/consensus for m sets $\{A_1, \dots, A_i, \dots, A_m\}$ is the following. Analogically, $\forall e \in \bigcup_{i=1}^m A_i$ two attributes are examined: “profit”/“utility” $c_e \geq 0$, required resource $b_e \geq 0$. Let $R_{\{A_i\}} = \tilde{S}_{\{A_i\}} \subseteq \bigcap_{i=1}^m A_i$ (or $R_{\{A_i\}} = M_{\{A_i\}}$) be a basic “consensus” set and $\sum_{e \in R_{AB}} b_e \leq b$, where b is a total resource. The problem of “extended median/consensus” is:

$$\begin{aligned} & \max \quad \sum_{e \in W \subseteq ((\bigcup_{i=1}^m A_i) \setminus R_{\{A_i\}})} c_e \\ s.t. \quad & \sum_{e \in W \subseteq ((\bigcup_{i=1}^m A_i) \setminus R_{\{A_i\}})} b_e \leq b. \end{aligned}$$

This model corresponds to basic knapsack problem.

7.2. Rankings. Median/consensus of rankings is one of the basic problems in decision making (e.g., [12], [35], [88], [89], [12], [88], [89]). Here three methods are briefly described: (i) median consensus method based on assignment problem (e.g., [34], [35], [36], [95]); (ii) heuristic approach (e.g., [16], [95], [152]); and (iii) method based on multiple choice problem (e.g., [100], [101]).

Method 1. The median consensus method based on distance (usually: Kendall-Tau distance) and assignment problem has been studied by Cook et al. (e.g., [34], [35], [36]). Our version of the approach (for layered sets) is the following. Let $A = \{1, \dots, i, \dots, n\}$ be the initial set of elements (alternatives, objects). The number of layers equals m ($k = \bar{1}, \bar{m}$). There are μ initial rankings of set A : $S^1, \dots, S^\lambda, \dots, S^\mu$. Thus, $S^\lambda = \bigcup_{k=1}^m A_k^\lambda$. Let r_i^λ ($i \in A$) be the priority of i in S^λ , i.e., the number of corresponding layer: $r_i^\lambda = k$ if $i \in A_k^\lambda$.

The resultant ranking (consensus) is $S^a = \{A_1^a, \dots, A_k^a, \dots, A_m^a\}$, and corresponding consensus priorities are $r_i^a \forall i \in A$. The following binary variable will be used:

$$x_{ik} = \begin{cases} 1, & \text{if } r_i^a = k \text{ or } i \in A_k^a, \\ 0, & \text{otherwise.} \end{cases}$$

The assignment problem for finding the consensus is (case of layered set):

$$\begin{aligned} \min & \sum_{i=1}^n \sum_{k=1}^m \left(\sum_{\lambda=1}^{\mu} |r_i^{\lambda} - k| \right) x_{ik} \\ \text{s.t.} & \sum_{k=1}^m x_{ik} = 1, i = \overline{1, n}; x_{ik} \in \{0, 1\}. \end{aligned}$$

Generally, polynomial algorithms exist for basic assignment problem (e.g., [57], [96]). The obtained version of assignment problem is more simple and can be solved by an evident greedy algorithm: selection of the closest layer $\forall i \in A$. Let us consider a numerical example (Table 7.1):

Table 7.1. Illustrative example for rankings

| $i \in A$ | $r_i^1 (S^1)$ | $r_i^2 (S^2)$ | $r_i^3 (S^3)$ | $r_i^a (S^a)$ | $\overline{r_i^a} (\overline{S^a})$ |
|-----------|---------------|---------------|---------------|---------------|-------------------------------------|
| 1 | 3 | 3 | 3 | 3 | 3 |
| 2 | 1 | 1 | 1 | 1 | 1 |
| 3 | 3 | 1 | 2 | 2 | 2 |
| 4 | 1 | 2 | 1 | 1 | 1 |
| 5 | 4 | 4 | 3 | 4 | 4 |
| 6 | 4 | 4 | 4 | 4 | 4 |
| 7 | 3 | 3 | 4 | 3 | 3 |
| 8 | 4 | 4 | 4 | 4 | 4 |
| 9 | 2 | 2 | 2 | 2 | 2 |

(a) initial set of elements $A = \{1, 2, 3, 4, 5, 6, 7, 8, 9\}$,

(b) three rankings (four layer are examined):

$$S^1 = \{A_1^1 = \{2, 4\}, A_2^1 = \{9\}, A_3^1 = \{1, 3, 7\}, A_4^1 = \{5, 6, 8\}\},$$

$$S^2 = \{A_1^2 = \{2, 3\}, A_2^2 = \{4, 9\}, A_3^2 = \{1, 7\}, A_4^2 = \{5, 6, 8\}\},$$

$$S^3 = \{A_1^3 = \{2, 4\}, A_2^3 = \{3, 9\}, A_3^3 = \{1, 5\}, A_4^3 = \{6, 7, 8\}\}.$$

The resultant ranking based on assignment problem above is (Table 10):

$$S^a = \{A_1^a = \{2, 4\}, A_2^a = \{3, 9\}, A_3^a = \{1, 7\}, A_4^a = \{5, 6, 8\}\}.$$

Method 2. A basic heuristic approach has been suggested in [16]. The method is widely used (e.g., [152]). Let us consider a simplified version of heuristic to find the corresponding solution $\overline{S^a}$:

$$\overline{r_i^a} = \begin{cases} \lceil (\sum_{\lambda=1}^{\mu} r_i^{\lambda}) / \mu \rceil, & \text{if } (\sum_{\lambda=1}^{\mu} r_i^{\lambda}) / \mu - \lceil (\sum_{\lambda=1}^{\mu} r_i^{\lambda}) / \mu \rceil < 0.5, \\ \lceil (\sum_{\lambda=1}^{\mu} r_i^{\lambda}) / \mu \rceil + 1, & \text{otherwise.} \end{cases}$$

Thus, solution $\overline{S^a}$ is (Table 10):

$$\overline{S^a} = \{\overline{A}_1^a = \{2, 4\}, \overline{A}_2^a = \{3, 9\}, \overline{A}_3^a = \{1, 7\}, \overline{A}_4^a = \{5, 6, 8\}\}.$$

Method 3. Now a more complicated aggregation process based on multiple choice problem is examined (initial rankings $\{S^\lambda | \lambda = \overline{1, \mu}\}$ are mapped into a fuzzy aggregated ranking S^a) $\{S^\lambda\} \Rightarrow S^a$ [101]:

$$h(S^a | s^a \in \{S | \eta(S, S^\lambda) \preceq \eta_o \forall \lambda = 1, \dots, \mu\}) \longrightarrow \max,$$

where h is an attribute (quality) of the resultant ('overage') structure S^a ; η_o is a vector-like proximity. The problem is depicted in Fig. 7.1.

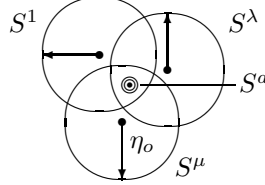

Fig. 7.1. Aggregation [101]

The following notations are used: a_{il} is the number of initial structures, in which element $i \in A_l$, $l = \overline{1, m}$ (layers); vector $\xi_i = (\xi_{i1}, \dots, \xi_{il}, \dots, \xi_{im})$ defines frequencies of belonging of element i to layers $\{A_1, \dots, A_l, \dots, A_m\}$, where $\xi_{il} = \frac{a_{il}}{a_i}$ (it is a membership function of element i to layer $l = 1, \dots, m$). Let us denote S_f^a as a set of intervals $\{d_i\}$. The resultant quality of S_f^a is based on the following entropy-like function:

$$\sum_{i=1}^n H_i = \sum_{i=1}^n \frac{1}{d_i^2 - d_i^1 + 1} \longrightarrow \max.$$

Next, a modular vector as the proximity is used: $z_o = (z^1, \dots, z^k, 0, \dots, 0)$. Finally, the problem is:

$$\sum_{i=1}^n H_i(S^a) \longrightarrow \max, \quad z(S^\lambda, S^a) \preceq z_o, \forall \lambda = 1, \dots, \mu.$$

With respect to zero-valued components z^{k+1}, \dots, z^{k^+} , it is possible to define a set of admissible variants to intervals $(d_{i\theta} | \theta = 1, \dots, q_i)$. Thus, we reduce the model to the following modification of multiple-choice problem ([57], [86]):

$$\sum_{i=1}^n \sum_{\theta=1}^{q_i} H_{i\theta}(d_{i\theta}) \kappa_{i\theta} \longrightarrow \max,$$

$$\sum_{r \geq p} \sum_{i=1}^n \sum_{\theta=1}^{q_i} b_{i\theta}^r \kappa_{i\theta} \leq \sum_{r \geq p} z^r, \quad p = 1, \dots, k, \quad \sum_{\theta=1}^{q_i} \kappa_{i\theta} = 1, \quad i = 1, \dots, n, \quad \kappa_{i\theta} \in \{0, 1\},$$

where $b_{i\theta}^r$ is the sum of components ξ_i , which are differed from $d_{i\theta}^1$ ($d_{i\theta}^2$) by r . A version of the described aggregation scheme has been implemented in DSS COMBI ([101], [115]).

7.3. Trees. Here initial information consists in a set of trees. Usually four basic approaches are considered:

- (1) maximum common subtree (e.g., [2], [54]);
- (2) median/agreement tree (e.g., [3], [19], [52], [64], [76], [133], [146]);
- (3) compatible tree (e.g., [19], [64], [67]); and
- (4) maximum agreement forest (e.g., [30], [66], [138], [164], [165]).

Mainly, the problems above correspond to class of NP-hard problems (e.g., [67], [133]). As a result, heuristics, approximation schemes, and enumerative methods are used.

Thus, the aggregation problem for set of initial trees $\{T\} = \{T^1, \dots, T^i, \dots, T^m\}$ can be considered as follows (addition strategy I):

Stage 1. Searching for a median-like tree (i.e., “kernel”):

$$T^{agg} = \arg \min_{\{T\}} \left(\sum_{i=1}^m \rho(T, T^i) \right).$$

Stage 2. Generation of a set of additional elements (nodes and/or edges).

Stage 3. Addition of elements to T^{agg} (knapsack-like problem).

Evidently, in the case of vector-like proximity $\bar{\rho}(T', T'')$, T^{agg} has to be searched for as Pareto-efficient solution(s). On the other hand, it is reasonable to consider some heuristic algorithms for building the “kernel”, for example:

$$K = \bigcup_{i=1}^{m-1} (T^i \cap T^{i+1}).$$

7.4. Morphological Structures. The basic aggregation problem for set of initial structures $\{\Lambda\} = \{\Lambda^1, \dots, \Lambda^i, \dots, \Lambda^m\}$ can be considered as follows (addition strategy I):

Stage 1. Searching for a median-like tree (i.e., “kernel”):

$$\Lambda^{agg} = \arg \min_{\{\Lambda\}} \left(\sum_{i=1}^m \rho(\Lambda, \Lambda^i) \right).$$

Stage 2. Generation of a set of additional elements (nodes and/or edges).

Stage 3. Addition of elements to Λ^{agg} (knapsack-like problem).

Evidently, in the case of vector-like proximity $\rho(\Lambda', \Lambda'')$, Λ^{agg} has to be searched for as Pareto-efficient solution(s). Generally, morphological structures (morphological structures with compatibility) are very complicated composite structures: $\Lambda = \langle \mathbf{T}, \mathbf{P}, \mathbf{D}, \mathbf{R}, \mathbf{I} \rangle$. Here, it may be reasonable to consider the following heuristic solving scheme:

Stage 1. Aggregation of sets of systems parts $\{\mathbf{P}\}$.

Stage 2. Aggregation of sets of DAs $\{\mathbf{D}\}$.

Stage 3. Aggregation of sets of compatibility estimates $\{\mathbf{I}\}$.

Stage 4. Aggregation of tree-like models $\{\mathbf{T}\}$.

8. ILLUSTRATIVE APPLIED NUMERICAL EXAMPLES

The list of examined applied examples is presented in Table 8.1.

Table 8.1. List of examined applied examples

| Applied example | Aggregation strategy | Taking into account compatibility | References for example |
|------------------------------------------|----------------------------------------------------------|-----------------------------------|---------------------------|
| 1. On-board telemetry system | addition (strategy I) | None | [116] |
| 2. Notebook | combined strategy (strategy III) | None | |
| 3. Zig-Bee protocol | (i) addition (strategy I) (ii) deletion (strategy II) | None None | [119] |
| 4. Integrated security system | addition (strategy I) | None | [117] |
| 5. Plan of students art activity | “kernel”-based strategy | None | [101] |
| 6. Combinatorial investment | “kernel”-based strategy | None | [101] |
| 7. Common educational course | (i) addition (strategy I) (ii) median-based strategy | None None | |
| 8. Educational course on design | extended strategy IV | Yes | [99], [101], [102], [106] |
| 9. Configuration of car | median-like strategy | | [109] |
| 10. Applied Web-based information system | (i) kernel-based strategy (ii) design strategy (IV) | Yes | [114] |

8.1. **ZigBee Communication Protocol.** Here an applied example for aggregation of ZigBee protocol solutions from [119] is briefly described. A general framework for aggregation of two solutions is depicted in Fig. 8.1. A brief description of Zigbee protocol components is the following [119]:

1. Interference avoidance *A*: 1.1. Startup Procedure of Channel Acquisition *X*.
- 1.2. Channel Hopping *J*.
2. Automated/distributed address management *B*.
3. Group addressing *I*.
4. Centralized data collection *C*: 4.1. Low-overhead data collection by ZigBee Coordinator *G*. 4.2 Low-overhead data collection by other devices *H*. 4.3. Many-to-one routing *Q*. 4.4. 6LoWPAN multicast/broadcast support *V*. 4.5. Source routing *P*.
5. Network scalability *D*.
6. Message size *E*.
7. Standardized commissioning *Z*.
8. Robust mesh networking: 6LoWPAN approach *U*.
9. Cluster Library support *L*.
10. Web services support *W*.

The above-mentioned system components have implementation alternatives (e.g., B_1 , B_2).

The following initial solutions are considered:

- (a) an expert-based forecast Θ^1 (\tilde{S}_4 from [119]) (Fig. 8.2),
- (b) forecast based on using knapsack problem Θ^2 ($\hat{\Phi}$ from [119]) (Fig. 8.3).

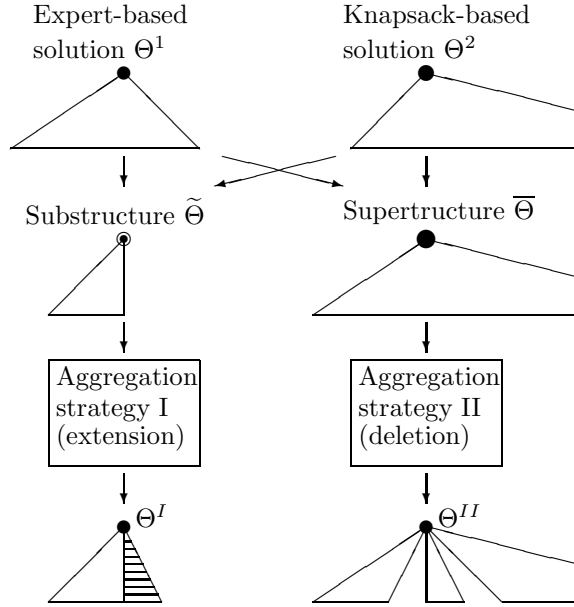

Fig 8.1. Example: aggregation for ZigBee protocol

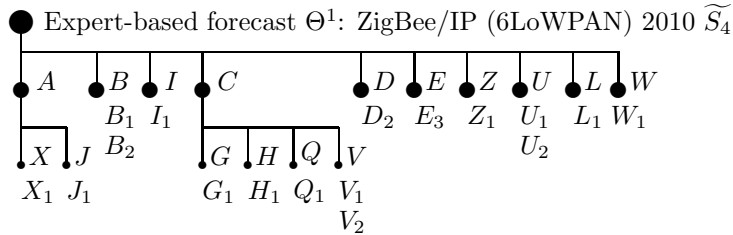

Fig. 8.2. Structure of direct expert-based forecast Θ^1 [119]

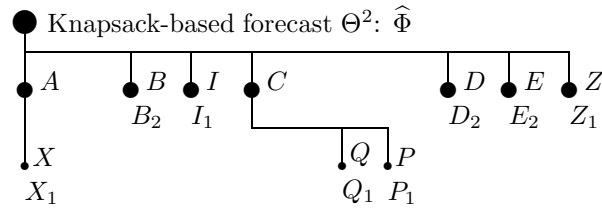

Fig. 8.3. Forecast based on knapsack problem Θ^2 [119]

The corresponding substructure of protocol $\tilde{\Theta}$ and superstructure of protocol $\bar{\Theta}$ are shown in Fig. 8.4 and in Fig. 8.5.

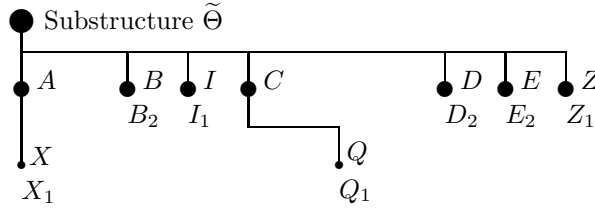

Fig. 8.4. Substructure of forecasts $\tilde{\Theta}$

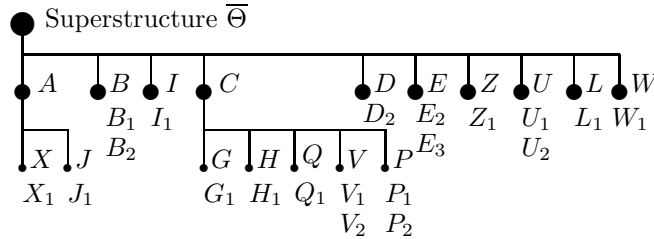

Fig. 8.5. Superstructure of forecasts $\bar{\Theta}$

Further, let us consider aggregation processes. A list of addition operations (for strategy I) is presented in Table 8.2 (designation of operation from [119] is depicted in parentheses). Here and hereafter the following attributes (criteria) for an assessment of the addition operations (deletion operations) are used [119]: (1) cost Υ_1 ; (2) required time for implementation Υ_2 ; (3) performance Υ_3 ; (4) decreasing a cost of maintenance Υ_4 ; (5) scalability Υ_5 ; (6) reliability Υ_6 ; (7) mobility Υ_7 ; and (8) usability value Υ_8 . An ordinal scale [1,5] is used for each criterion: 1 corresponds to “strong negative effect”, 2 corresponds to “negative effect”, 3 corresponds to “no changes”, 4 corresponds to “positive effect”, and 5 corresponds to “strong positive effect”. Priorities $\{r_i\}$ are obtained via multicriteria ranking (Electre-like method [119]).

Table 8.2. Addition operations (estimates, priorities)

| i | Improvement operation | Vari-able | Υ_1 | Υ_2 | Υ_3 | Υ_4 | Υ_5 | Υ_6 | Υ_7 | Υ_8 | Priori-ties r_i |
|-----|------------------------------|-----------|--------------|--------------|--------------|--------------|--------------|--------------|--------------|--------------|-------------------|
| 1 | J_1 (Φ_{10}) | x_1 | 2 | 3 | 4 | 4 | 3 | 4 | 4 | 3 | 1 |
| 2 | B_1 (Φ_{13}) | x_2 | 3 | 3 | 3 | 4 | 3 | 3 | 4 | 3 | 3 |
| 3 | $U_1 \& U_2$ (Φ_{17}) | x_3 | 3 | 3 | 4 | 3 | 4 | 3 | 3 | 3 | 3 |
| 4 | L_1 (Φ_3) | x_4 | 3 | 4 | 3 | 4 | 3 | 5 | 3 | 4 | 1 |
| 5 | W_1 (Φ_{15}) | x_5 | 3 | 3 | 2 | 3 | 4 | 3 | 3 | 5 | 2 |

Thus, the addition problem (simplified knapsack problem) is:

$$\max \sum_{i=1}^5 c_i x_i$$

$$s.t. \sum_{i=1}^5 a_i x_i \leq b, x_i \in \{0, 1\}.$$

Cost estimates are (by criterion Υ_1) used as $\{a_i\}$, priorities $\{r_i\}$ are used as (transform to) $\{c_i\}$, and $b = 8.00$.

A resultant solution for strategy I is depicted in Fig. 8.6 ($x_1 = 1, x_2 = 1, x_3 = 0, x_4 = 0, x_5 = 1$). Here compatibility estimates between design alternatives for system components are not considered.

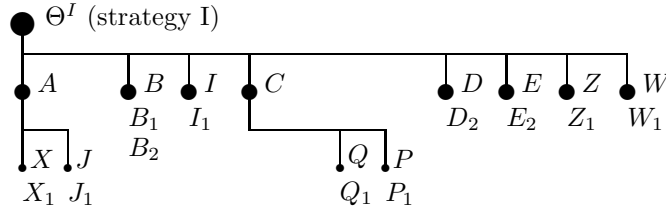

Fig. 8.6. Aggregated solution Θ^I based on strategy I

A list of deletion operations (for strategy II) is presented in Table 8.3 (designation of operation from [119] is depicted in parentheses).

Table 8.3. Deletion operations (estimates, priorities)

| i | Deletion operation | Variable | Υ_1 | Υ_2 | Υ_3 | Υ_4 | Υ_5 | Υ_6 | Υ_7 | Υ_8 | Priorities r_i |
|-----|------------------------------|----------|--------------|--------------|--------------|--------------|--------------|--------------|--------------|--------------|------------------|
| 1 | J_1 (Φ_{10}) | x_1 | 2 | 3 | 4 | 4 | 3 | 4 | 4 | 3 | 1 |
| 2 | B_1 (Φ_{13}) | x_2 | 3 | 3 | 3 | 4 | 3 | 3 | 4 | 3 | 3 |
| 3 | Q_1 (Φ_7) | x_3 | 3 | 4 | 3 | 3 | 3 | 2 | 3 | 3 | 4 |
| 4 | P_1 (Φ_8) | x_4 | 3 | 4 | 4 | 4 | 3 | 4 | 3 | 3 | 2 |
| 5 | E_3 (Φ_{14}) | x_5 | 3 | 3 | 3 | 3 | 5 | 3 | 3 | 3 | 2 |
| 6 | L_1 (Φ_3) | x_6 | 3 | 4 | 3 | 4 | 3 | 5 | 3 | 4 | 1 |
| 7 | $U_1 \& U_2$ (Φ_{17}) | x_7 | 3 | 3 | 4 | 3 | 4 | 3 | 3 | 3 | 3 |

Thus, the deletion problem (knapsack problem with minimization of the objective function) is:

$$\min \sum_{i=1}^6 c_i x_i$$

$$s.t. \sum_{i=1}^6 a_i x_i \geq b, x_i \in \{0, 1\}.$$

Cost estimates are (by criterion Υ_1) used as $\{a_i\}$, priorities $\{r_i\}$ are used as (transform to) $\{c_i\}$, and $b = 8.00$.

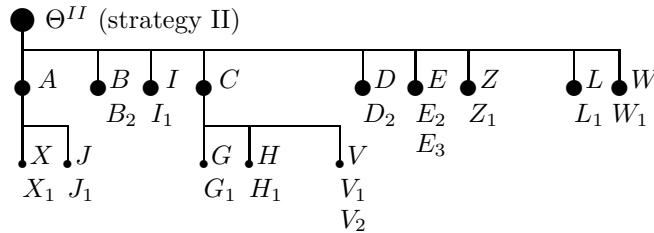

Fig. 8.7. Aggregated solution Θ^{II} based on strategy II

A resultant solution based on strategy II is depicted in Fig. 8.7 ($x_1 = 0, x_2 = 1, x_3 = 1, x_4 = 1, x_5 = 0, x_6 = 0, x_7 = 1$). Here compatibility estimates between design alternatives for system components are not considered.

8.2. On-Board Telemetry System. Here a numerical example for on-board telemetry system is considered from [116]. The initial morphological structure for on-board equipment is the following (Fig. 8.8):

1. On-board equipment $S = D \star E \star P$.

1.1. Power supply $D = X \star Y \star Z$: 1.1.1. stabilizer X : X_1 (standard), X_2 (transistorized), X_3 (high-stability); 1.1.2. main source Y : Y_1 (Li-ion), Y_2 (Cd-Mn), Y_3 (Li); 1.1.3. emergency cell Z : Z_1 (Li-ion), Z_2 (Cd-Mn), Z_3 (Li).

1.2. Sensor element $E = I \star O \star G$: 1.2.1. acceleration sensors I : I_1 (ADXL), I_2 (ADIS), I_3 (MMA); 1.2.2. position sensors O : O_1 (SS12), O_2 (SS16), O_3 (SS19), O_4 (SS49), O_5 (SS59), O_6 (SS94); 1.2.3. global positioning system (GPS) G : G_1 (EB), G_2 (GT), G_3 (LS), G_4 (ZX).

1.3. Data processing system $P = H \star C \star W$: 1.3.1. data storage unit H : H_1 (SRAM), H_2 (DRAM), H_3 (FRAM); 1.3.2. processing unit (CPU) C : C_1 (AVR), C_2 (ARM), C_3 (ADSP), C_4 (BM); 1.3.3. data write unit W : W_1 (built-in ADC), W_2 (external ADC I2C), W_3 (external ADC SPI), W_4 (external ADC 2W), W_5 (external ADC UART(1)).

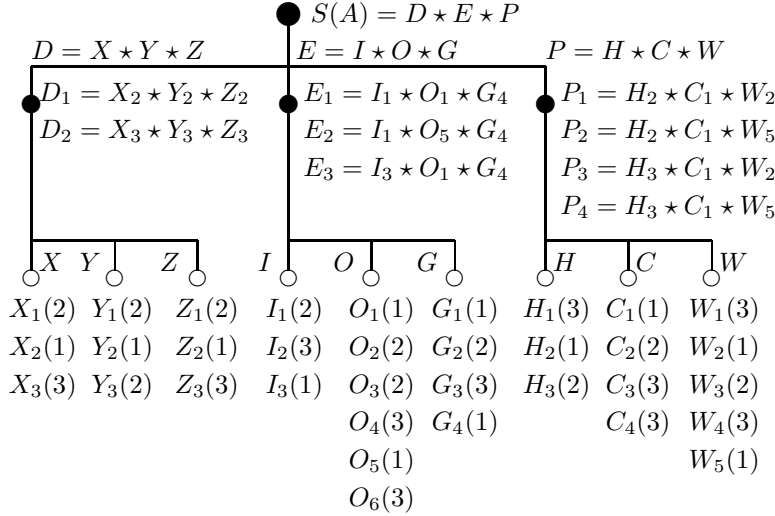
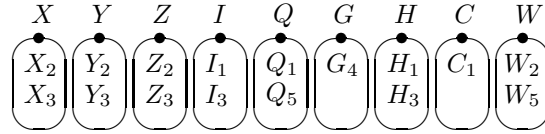
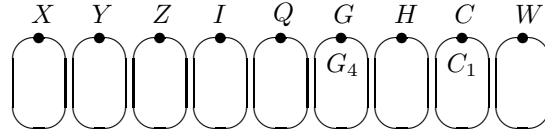

Fig. 8.8. Basic hierarchy for on-board telemetry system [116]

In [116], 24 resultant solutions have been obtained via HMMD (A_1, \dots, A_{24}). In the example, 6 initial solutions are examined (in parentheses designation from [116] in pointed out):

$$\begin{aligned}
 S_1(A_1) &= D_1 \star E_1 \star P_1 = (X_2 \star Y_2 \star Z_2) \star (I_1 \star Q_1 \star G_4) \star (H_2 \star C_1 \star W_2), \\
 S_2(A_{24}) &= D_2 \star E_3 \star P_4 = (X_3 \star Y_3 \star Z_3) \star (I_3 \star Q_1 \star G_4) \star (H_3 \star C_1 \star W_5), \\
 S_3(A_{11}) &= D_1 \star E_3 \star P_3 = (X_2 \star Y_2 \star Z_2) \star (I_3 \star Q_1 \star G_4) \star (H_3 \star C_1 \star W_2), \\
 S_4(A_{19}) &= D_2 \star E_2 \star P_3 = (X_3 \star Y_3 \star Z_3) \star (I_1 \star Q_5 \star G_4) \star (H_3 \star C_1 \star W_2), \\
 S_5(A_{23}) &= D_2 \star E_3 \star P_3 = (X_3 \star Y_3 \star Z_3) \star (I_3 \star Q_1 \star G_4) \star (H_3 \star C_1 \star W_2), \\
 S_6(A_{12}) &= D_1 \star E_3 \star P_4 = (X_2 \star Y_2 \star Z_2) \star (I_3 \star Q_1 \star G_4) \star (H_3 \star C_1 \star W_5).
 \end{aligned}$$

In Fig. 8.9 and Fig. 8.10, supersolution and subsolution are depicted.

Fig. 8.9. Supersolution $\bar{\Theta}$ Fig. 8.10. Subsolution $\tilde{\Theta}$

The obtained subsolution contains only two elements. Thus, the design of “system kernel” is based on the special method with $\alpha = 0.6$ (Fig. 8.11).

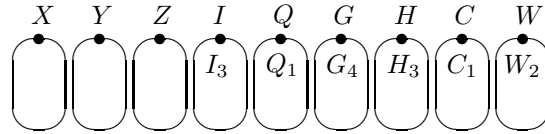
Fig. 8.11. “System kernel” K

Further, the addition strategy as simplified multiple choice problem is used:

$$\max \sum_{i=1}^3 \sum_{j=1}^2 c_{ij} x_{ij}$$

$$s.t. \sum_{i=1}^3 \sum_{j=1}^2 a_{ij} x_{ij} \leq b, \sum_{j=1}^2 x_{ij} = 1 \forall i = \overline{1, 3}; x_{ij} \in \{0, 1\}.$$

A list of addition operations is presented in Table 8.4 [116]. Here cost estimates are based on expert judgment, priorities $\{r_i\}$ were computed via Electre-like method in [116] and transformed to $\{c_i\}$, $b = 9.00$.

A resultant solution is depicted in Fig. 8.12 ($x_{11} = 1$, $x_{12} = 0$, $x_{21} = 1$, $x_{22} = 0$, $x_{31} = 1$, $x_{32} = 0$). Note, compatibility estimates between design alternatives for system components X , Y , Z are not considered.

Table 8.4. Addition operations

| Improvement operation | Binary variable | Cost | Priorities r_i |
|-----------------------|-----------------|------|------------------|
| X_2 | x_{11} | 3 | 1 |
| X_3 | x_{12} | 4 | 3 |
| Y_2 | x_{21} | 2 | 1 |
| Y_3 | x_{22} | 3 | 2 |
| Z_2 | x_{31} | 2 | 1 |
| Z_3 | x_{32} | 3 | 2 |

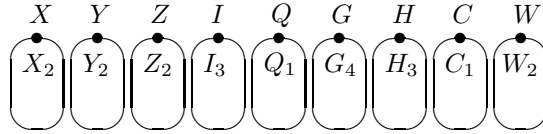

Fig. 8.12. Resultant aggregated solution

8.3. Continuation of Example for Notebook. Let us examine the final part of the example for notebook. Here the combined aggregation strategy (strategy III) is considered for two cases:

- (1) “system kernel” as an extension of substructure:
 $K' = B_1 \star R_1 \star V_3 \star J_1 \star E_1 \star O_1 \star D_1 \star A_1 \star G_1 \star L_1 \star Q_2$;
- (2) “system kernel” K^* based on multicriteria selection of the “best” design alternatives for each system component.

Let us consider case 1. Here the aggregation strategy as modification of “system kernel” K' can be applied. A set of candidate modification operations are the following:

- 1. addition operations: 1.1. addition for U : U_1 or U_2 or U_3 , 1.2. addition for F : F_1 or F_2 , 1.3. addition for P : P_2 or P_3 or P_4 ;
- 2. correction operations: 2.1. replacement $B_1 \Rightarrow B_2$, 2.2. replacement $V_3 \Rightarrow V_4$, 2.3. replacement $A_1 \Rightarrow A_3$.

Table 8.5 contains the list of modification operations above, their estimates (ordinal expert judgment) and corresponding binary variables.

Table 8.5. Modification operations

| Operations | Binary variable | Cost a_{ij} | Priorities r_{ij} |
|----------------------------|-----------------|---------------|---------------------|
| 1. Addition | | | |
| 1.1. U_1 | x_{11} | 3 | 2 |
| 1.1. U_2 | x_{12} | 2 | 3 |
| 1.1. U_3 | x_{13} | 4 | 1 |
| 1.2. F_1 | x_{21} | 2 | 2 |
| 1.2. F_2 | x_{22} | 3 | 1 |
| 1.3. P_2 | x_{31} | 3 | 1 |
| 1.3. P_3 | x_{32} | 2 | 1 |
| 1.3. P_4 | x_{33} | 0 | 2 |
| 2. Replacement | | | |
| 2.1. $B_1 \Rightarrow B_3$ | x_{41} | 4 | 1 |
| 2.1. None | x_{42} | 0 | 2 |
| 2.2. $V_3 \Rightarrow V_4$ | x_{51} | 3 | 1 |
| 2.2. None | x_{52} | 0 | 2 |
| 2.3. $A_1 \Rightarrow A_3$ | x_{61} | 2 | 1 |
| 2.3. None | x_{62} | 0 | 2 |

The following simplified multiple choice problem is used ($c_{ij} = 3 - r_{ij}$, $b = 11.00$):

$$\max \sum_{i=1}^6 \sum_{j=1}^{q_i} c_{ij} x_{ij}$$

$$s.t. \sum_{i=1}^6 \sum_{j=1}^{q_i} a_{ij} x_{ij} \leq b, \sum_{j=1}^{q_i} x_{ij} = 1 \forall i = \overline{1,6}; x_{ij} \in \{0,1\}.$$

A resultant computer solution S^{1c} is depicted in Fig. 8.13 ($x_{11} = 1, x_{12} = 0, x_{13} = 0, x_{21} = 0, x_{22} = 1, x_{31} = 0, x_{32} = 1, x_{33} = 0, x_{41} = 0, x_{42} = 1, x_{51} = 0, x_{52} = 1, x_{61} = 1, x_{62} = 0$). Here a greedy algorithm was used. Note, compatibility estimates between design alternatives for system components are not considered.

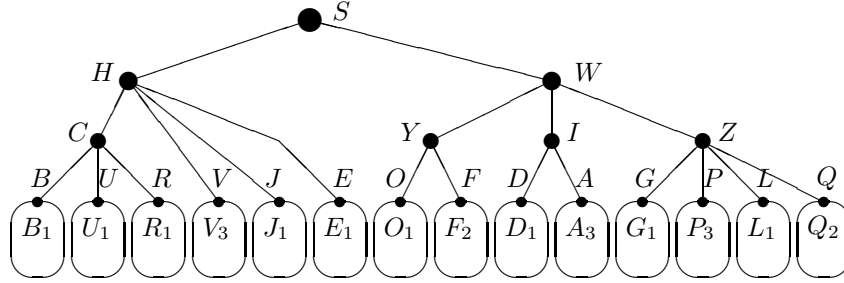

Fig. 8.13. Solution S^{1c} based on modification of “system kernel” K'

Now let us consider case 2. Here building of “system kernel” is based on multi-criteria selection and/or expert judgment. The basic structure of “system kernel” is: B, U, R, V, O, F, D, G . For each system component above, it is possible to consider a selection procedure to choose the “best” system element (while taking into account elements of the initial solution or additional elements as well).

Table 8.6 contains design alternatives for the selected components of “system kernel” structure above including ordinal estimates (expert judgment, the smallest estimates correspond to the best situation) and the resultant priorities. The following criteria were used: cost (Υ_1), usefulness (Υ_2), experience (Υ_3), prospective features (Υ_4). As a result, the following “system kernel” K^* is obtained: $K^* = B_2 \star U_2 \star R_3 \star V_3 \star E_1 \star O_1 \star F_2 \star D_1 \star G_1$.

Further, the system correction process is based on the following operations:

1. addition: 1.1. A_1 , 1.2. P_1 , 1.3. L_1 ;
2. deletion: 2.1. E_1 ;
3. replacement: 3.1. $B_2 \Rightarrow B_3$, 3.2. $U_2 \Rightarrow U_1$, 3.3. $O_1 \Rightarrow O_3$.

Table 8.7 contains the list of modification operations above, their estimates (ordinal expert judgment) and corresponding binary variables.

The following multiple choice problem is used ($c_{ij} = 3 - r_{ij}, b = 9.00$):

$$\max \sum_{i=1}^7 \sum_{j=1}^2 c_{ij} x_{ij}$$

$$s.t. \sum_{i=1}^7 \sum_{j=1}^2 a_{ij} x_{ij} \leq b, \sum_{j=1}^2 x_{ij} = 1 \forall i = \overline{1,7}; x_{ij} \in \{0,1\}.$$

A resultant computed solution S^{2c} is depicted in Fig. 8.14 ($x_{11} = 1, x_{12} = 0, x_{21} = 0, x_{22} = 1, x_{31} = 1, x_{32} = 0, x_{41} = 1, x_{42} = 0, x_{51} = 1, x_{52} = 0, x_{61} = 0, x_{62} = 1, x_{71} = 1, x_{72} = 0$). Here a greedy algorithm was used. Note, compatibility estimates between design alternatives for system components are not considered.

Table 8.6. Design alternatives, estimates and priorities

| Design alternatives | Criteria | | | | Priority r_i |
|---------------------|--------------|--------------|--------------|--------------|----------------|
| | Υ_1 | Υ_2 | Υ_3 | Υ_4 | |
| B_1 | 3 | 2 | 1 | 2 | 2 |
| B_2 | 2 | 2 | 1 | 2 | 1 |
| B_3 | 4 | 1 | 1 | 1 | 2 |
| U_1 | 3 | 2 | 1 | 2 | 2 |
| U_2 | 2 | 2 | 1 | 3 | 1 |
| U_3 | 4 | 1 | 1 | 1 | 2 |
| R_1 | 1 | 3 | 1 | 3 | 3 |
| R_2 | 2 | 2 | 2 | 3 | 3 |
| R_3 | 2 | 2 | 2 | 2 | 1 |
| R_4 | 3 | 1 | 3 | 1 | 2 |
| V_1 | 1 | 2 | 1 | 3 | 3 |
| V_2 | 2 | 1 | 1 | 2 | 2 |
| V_3 | 3 | 1 | 2 | 1 | 1 |
| V_4 | 4 | 1 | 2 | 1 | 2 |
| E_1 | 2 | 1 | 2 | 1 | 1 |
| E_2 | 0 | 2 | 1 | 2 | 2 |
| O_1 | 2 | 2 | 1 | 2 | 1 |
| O_2 | 3 | 1 | 2 | 2 | 2 |
| O_3 | 1 | 1 | 3 | 1 | 2 |
| F_1 | 2 | 2 | 1 | 3 | 2 |
| F_2 | 3 | 1 | 2 | 2 | 1 |
| D_1 | 1 | 1 | 1 | 1 | 1 |
| D_2 | 0 | 2 | 2 | 2 | 2 |
| G_1 | 4 | 1 | 1 | 1 | 1 |
| G_2 | 4 | 2 | 3 | 2 | 3 |
| G_3 | 3 | 2 | 3 | 2 | 3 |
| G_4 | 2 | 3 | 2 | 3 | 2 |

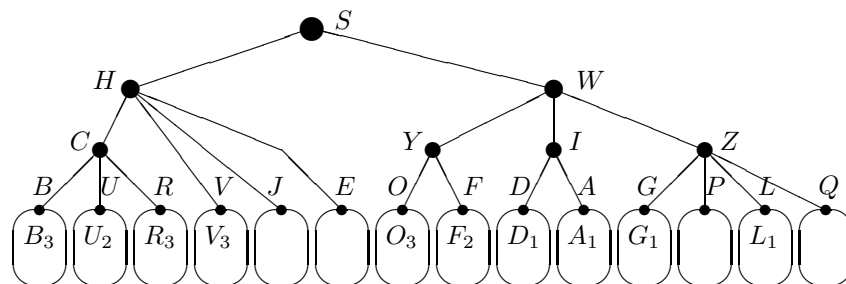

Fig. 8.14. Solution S^{2c}

Table 8.7. Modification operations

| Operations | Binary variable | Cost a_{ij} | Priorities r_{ij} |
|----------------------------|-----------------|---------------|---------------------|
| 1. Addition | | | |
| 1.1. A_1 | x_{11} | 1 | 1 |
| 1.1. None | x_{12} | 0 | 3 |
| 1.2. P_1 | x_{21} | 3 | 2 |
| 1.2. None | x_{22} | 0 | 3 |
| 1.3. L_1 | x_{31} | 1 | 1 |
| 1.3. None | x_{32} | 0 | 3 |
| 2. Deletion | | | |
| 2.1. E_1 | x_{41} | 1 | 1 |
| 2.2. None | x_{42} | 0 | 2 |
| 3. Replacement | | | |
| 3.1. $B_2 \Rightarrow B_3$ | x_{51} | 4 | 1 |
| 3.1. None | x_{52} | 0 | 3 |
| 3.2. $U_2 \Rightarrow U_1$ | x_{61} | 3 | 2 |
| 3.2. None | x_{62} | 0 | 3 |
| 3.3. $O_1 \Rightarrow O_3$ | x_{71} | 1 | 1 |
| 3.3. None | x_{72} | 0 | 3 |

8.4. Integrated Security System. Here a numerical example for integrated security system is considered from [117]. The initial morphological structure is the following (Fig. 8.15):

0. Integrated security system $S = A \star B \star O$.

1. Closed-circuit television (CCTV) $A = J \star D$:

1.1. Cameras J : conventional $J_1(2)$, “Tirret” $J_2(2)$, “varifocal” $J_3(3)$, and “auto-house” $J_4(1)$.

1.2. Lighting D : natural $D_1(3)$, natural and guard $D_2(2)$, and natural, guard, and alarm $D_3(1)$.

2. Access control $B = G \star U \star V$:

2.1. Access to territory G : card $G_1(1)$, radio-pendant $G_2(3)$, and biometry $G_3(2)$.

2.2. Access to building U : card $U_1(1)$, radio-pendant $U_2(3)$, and biometry $U_3(2)$.

2.3. Access to premises V : card $V_1(1)$, code $V_2(2)$, biometry $V_3(2)$, $V_4 = V_1 \& V_2(2)$, $V_5 = V_1 \& V_3(3)$, and $V_6 = V_1 \& V_2 \& V_3(3)$.

3. Burglar alarm $O = X \star Y \star Z$:

3.1. Border-line 1 based on some principles X : single physical principle $X_1(1)$, two physical principles $X_2(2)$, and three physical principles $X_3(3)$.

3.2. Border-line 2 based on some principles Y : single physical principle $Y_1(1)$, two physical principles $Y_2(3)$, and three physical principles $Y_3(2)$.

3.3. Border-line 3 based on some principles Z : single physical principle $Z_1(1)$, two physical principles $Z_2(3)$, and three physical principles $Z_3(2)$.

In [117], two resultant solutions have been obtained (via HMMD):

$$S_1 = A_1 \star B_1 \star O_1 = (J_2 \star D_1) \star (G_1 \star U_1 \star V_1) \star (X_3 \star Y_3 \star Z_3),$$

$$S_2 = A_1 \star B_1 \star O_1 = (J_2 \star D_1) \star (G_1 \star U_1 \star V_1) \star (X_1 \star Y_1 \star Z_1).$$

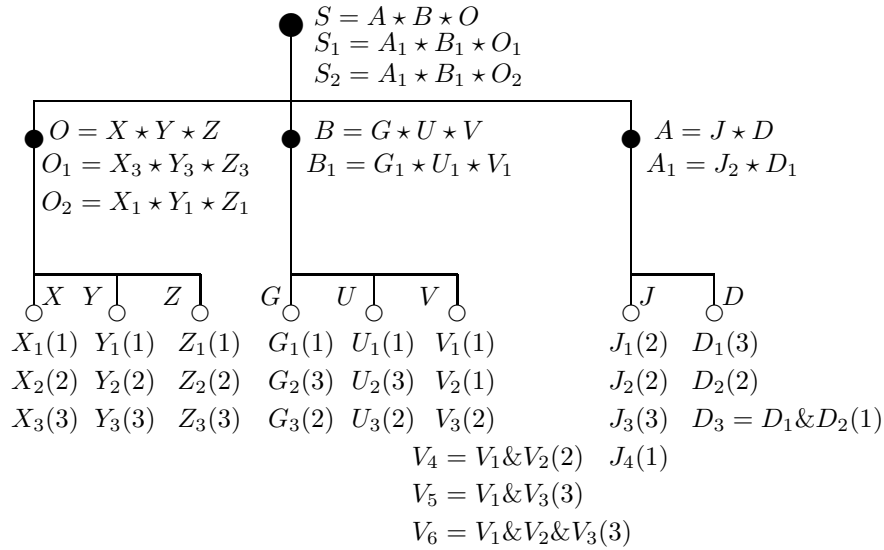
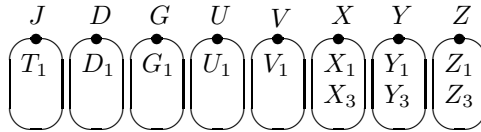
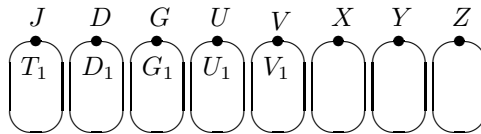

Fig. 8.15. Basic hierarchy for integrated security system [117]

In Fig. 8.16 and Fig. 8.17, supersolution and subsolution are depicted.

 Fig. 8.16. Supersolution $\bar{\Theta}$

 Fig. 8.17. Subsolution $\tilde{\Theta}$

Here, the obtained subsolution can be used as “system kernel”, i.e., $K = \tilde{\Theta}$. Further, the addition strategy as simplified multiple choice problem is used:

$$\max \sum_{i=1}^3 \sum_{j=1}^2 c_{ij} x_{ij}$$

$$s.t. \sum_{i=1}^3 \sum_{j=1}^2 a_{ij} x_{ij} \leq b, \sum_{j=1}^2 x_{ij} = 1 \forall i = \overline{1, 3}; x_{ij} \in \{0, 1\}.$$

A list of addition operations is presented in Table 8.8 [117]. Here cost estimates are based on expert judgment, priorities $\{r_i\}$ were computed via Electre-like method in [117] and transformed to $\{c_i\}$, $b = 7.00$.

A resultant solution is depicted in Fig. 8.18 ($x_{11} = 1, x_{12} = 0, x_{21} = 1, x_{22} = 0, x_{31} = 1, x_{32} = 0$). Note, compatibility estimates between design alternatives for system components X, Y, Z are not considered.

Table 8.8. Addition operations

| Improvement operation | Binary variable | Cost | Priorities r_i |
|-----------------------|-----------------|------|------------------|
| X_1 | x_{11} | 3 | 1 |
| X_3 | x_{12} | 4 | 3 |
| Y_1 | x_{21} | 2 | 1 |
| Y_3 | x_{22} | 3 | 3 |
| Z_1 | x_{31} | 2 | 1 |
| Z_3 | x_{32} | 3 | 3 |

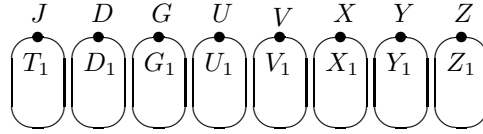

Fig. 8.18. Resultant aggregated solution

8.5. Common Educational Course. Here the following initial sets are considered (Table 8.9):

- (i) initial set of educational modules for a basic course on combinatorial optimization $A = \{1, \dots, i, \dots, n\} = \{1, 2, 3, 4, 5, 6, 7, 8, 9, 10, 11, 12, 13, 14, 15, 16\}$,
- (ii) initial set of educational modules for a course on combinatorial optimization for students in “communication systems” $A^1 = \{1, 2, 3, 4, 5, 7, 8, 9, 10, 11, 12, 13, 14\} \subseteq A$, and
- (iii) initial set of educational modules for a course on combinatorial optimization for students in “information systems” $A^2 = \{1, 2, 3, 4, 5, 6, 7, 9, 10, 12, 15\} \subseteq A$.

The aggregation problem is:

Design a common course for students in “communication systems” and “information systems” $A^0 \subseteq A$ while taking into account weights of educational modules $(\{w_i\}, \{w_i^1\}, \{w_i^2\})$.

Here two solving strategies are considered:

1. Addition strategy (strategy I).
2. Median-based strategy.

Let us examine the first case. The following “system kernel” is considered: $K = A^1 \cap A^2 = \{1, 2, 3, 4, 5, 7, 9, 10, 12\}$. The set of elements for addition is:

$$B = \{i \in A \setminus (A^1 \cap A^2) \mid (w_i^1 \geq 0.73) \cup (w_i^2 \geq 0.73)\} = \{6, 8, 11, 14, 15\}.$$

Here, three design versions (alternatives) are considered $i \in B$: V_1^i (None), V_2^i (compressed version), and V_3^i (normal version) ($j = \overline{1, 3}$). Table 8.10 contains the description of the addition elements and corresponding versions.

Table 8.9. Illustrative numerical example

| i | Topic | A | $w_i(A)$ | A^1 | $w_i(A^1)$ | A^2 | $w_i(A^2)$ | $A^1 \cup A^2$ | $A^1 \cap A^2$ |
|-----|-------------------------|-----|----------|-------|------------|-------|------------|----------------|----------------|
| 1 | Optimization | * | 1.0 | * | 0.6 | * | 0.6 | * | * |
| 2 | Complexity issues | * | 1.0 | * | 0.7 | * | 0.7 | * | * |
| 3 | Selection/sorting | * | 1.0 | * | 0.6 | * | 1.0 | * | * |
| 4 | Knapsack problem | * | 1.0 | * | 0.4 | * | 1.0 | * | * |
| 5 | Clustering | * | 1.0 | * | 1.0 | * | 1.0 | * | * |
| 6 | Multiple-choice problem | * | 1.0 | | 0.0 | * | 0.76 | * | |
| 7 | Spanning tree | * | 1.0 | * | 1.0 | * | 0.3 | * | * |
| 8 | Routing | * | 1.0 | * | 1.0 | | 0.0 | * | |
| 9 | Assignment | * | 1.0 | * | 0.8 | * | 0.4 | * | * |
| 10 | Scheduling | * | 1.0 | * | 0.4 | * | 0.8 | * | * |
| 11 | TSP | * | 1.0 | * | 0.75 | | 0.0 | * | |
| 12 | Covering | * | 1.0 | * | 0.8 | * | 0.7 | * | * |
| 13 | Steiner tree | * | 1.0 | * | 0.7 | | 0.0 | * | |
| 14 | Graph coloring | * | 1.0 | * | 0.73 | | 0.0 | * | |
| 15 | SAT problem | * | 1.0 | | 0.0 | * | 0.8 | * | |
| 16 | Alignment | * | 1.0 | | 0.0 | | 0.0 | | |

Table 8.10. Addition elements

| κ | Binary variable | Version V_j^i | i | $c_{\kappa j}$ | $a_{\kappa j}$ |
|----------|-----------------|-----------------|-----|----------------|----------------|
| 1 | x_{11} | V_1^6 | 6 | 0.0 | 0.0 |
| 1 | x_{12} | V_2^6 | 6 | 0.4 | 0.5 |
| 1 | x_{13} | V_3^6 | 6 | 0.76 | 1.0 |
| 2 | x_{21} | V_1^8 | 8 | 0.0 | 0.0 |
| 2 | x_{22} | V_2^8 | 8 | 0.5 | 0.5 |
| 2 | x_{23} | V_3^8 | 8 | 1.0 | 1.0 |
| 3 | x_{31} | V_1^{11} | 11 | 0.0 | 0.0 |
| 3 | x_{32} | V_2^{11} | 11 | 0.45 | 0.5 |
| 3 | x_{33} | V_3^{11} | 11 | 0.75 | 1.0 |
| 4 | x_{41} | V_1^{14} | 14 | 0.0 | 0.0 |
| 4 | x_{42} | V_2^{14} | 14 | 0.4 | 0.5 |
| 4 | x_{43} | V_3^{14} | 14 | 0.73 | 1.0 |
| 5 | x_{51} | V_1^{15} | 15 | 0.0 | 0.0 |
| 5 | x_{52} | V_2^{15} | 15 | 0.4 | 0.5 |
| 5 | x_{53} | V_3^{15} | 15 | 0.8 | 1.0 |

Thus, the addition problem (multiple choice problem) is:

$$\max \sum_{\kappa=1}^5 \sum_{j=1}^3 c_{\kappa j} x_{\kappa j}$$

$$s.t. \sum_{\kappa=1}^5 \sum_{j=1}^3 a_{\kappa j} x_{\kappa} \leq b, \sum_{j=1}^3 x_{\kappa j} \leq 1 \forall \kappa, x_{\kappa j} \in \{0, 1\}.$$

Here $c_{\kappa 3} = \max(w_{\kappa}^1, w_{\kappa}^2)$, estimate of $a_{\kappa j}$ is based on expert judgment (Table 8.10), and $b = 3.50$.

A resultant solution based on strategy I is depicted in Fig. 8.19 ($x_{11} = 0, x_{12} = 0, x_{13} = 1, x_{21} = 0, x_{22} = 0, x_{23} = 1, x_{31} = 1, x_{32} = 0, x_{33} = 0, x_{41} = 0, x_{42} = 1, x_{43} = 0, x_{51} = 0, x_{52} = 0, x_{53} = 1$). Evidently, normal version V_3^i is used for elements of “system kernel” K . The solving process was based on a greedy algorithm. Here compatibility estimates between design alternatives for system components were not considered.

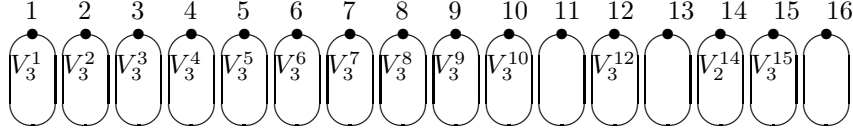

Fig. 8.19. Aggregated common course (addition strategy)

In the second case, Pareto-efficient median-solutions $\{A^0\}$ are searched for through the following two-component vector criterion $\bar{\rho} = (\rho^1(A^0, A^1), \rho^2(A^0, A^2))$ (by weights $\{w_i^1\}$ and $\{w_i^2\}$):

$$\min \rho^1(A^0, A^1) = 1 - \frac{\sum_{i \in (A^0 \cap A^1)} w_i^1}{\sum_{i \in (A^0 \cup A^1)} w_i^1}, \quad \min \rho^2(A^0, A^2) = 1 - \frac{\sum_{i \in (A^0 \cap A^2)} w_i^2}{\sum_{i \in (A^0 \cup A^2)} w_i^2}.$$

Generally, the problem of searching for the median belongs to class of NP-hard problems. Let us consider an approximation heuristic. Initial elements for the median are the following (i.e., deletion of element 16):

$$\{1, 2, 3, 4, 5, 6, 7, 8, 9, 10, 11, 12, 13, 14, 15\}.$$

Thus, cardinality of search space is: $|\{A^0\}| = 2^{15}$.

First, let us assume that elements $\{1, 2, 5\}$ will be included into each median-solution (to decrease problem dimension) and, as a result, $|\{A^0\}| = 2^{12}$.

Second, elements from set $\{3, 4, 9, 10, 11, 12\}$ will be included into each median solution as well and, as a result, $|\{A^0\}| = 2^6 = 64$.

Finally, only six submedian-solutions are selected for examination:

$$A^{01} = \{7, 8, 13, 14, 15\}, A^{02} = \{6, 8, 13, 14, 15\}, A^{03} = \{6, 7, 13, 14, 15\}, \\ A^{04} = \{6, 7, 8, 14, 15\}, A^{05} = \{6, 7, 8, 13, 15\}, A^{06} = \{6, 7, 8, 13, 14\}.$$

Table 92 contains the subsolutions ($\kappa = \overline{1, 6}$), corresponding values of vector $\bar{\rho}(A^{0\kappa}) = (\rho^{1\kappa}(A^{0\kappa}, A^1), \rho^{2\kappa}(A^{0\kappa}, A^2))$, and information on inclusion into the layer of Pareto-efficient solutions. Here parts of A^1 and A^2 are considered, which correspond to $\{6, 7, 8, 13, 14, 15\}$: $\{7, 8, 13, 14\}$ (for A^1) and $\{6, 7, 13, 15\}$ (for A^2).

Thus, the following preference relation is obtained over the six subsolutions above: $A^{01} \succeq A^{06}$ and $A^{04} \succeq A^{05} \succeq A^{03} \succeq A^{02}$.

Finally, subsolutions A^{01} and A^{04} are Pareto-efficient ones (Table 8.11, Fig. 8.20).

Table 8.11. Candidate-substitutions

| κ | Candidate substitution $A^{0\kappa}$ | $\rho^1(A^{0\kappa}, A^1)$ | $\rho^2(A^{0\kappa}, A^2)$ | Inclusion into Pareto-layer |
|----------|--------------------------------------|----------------------------|----------------------------|-----------------------------|
| 1 | $A^{01} = \{7, 8, 13, 14, 15\}$ | 0.00 | 0.40 | ★ |
| 2 | $A^{02} = \{6, 8, 13, 14, 15\}$ | 0.30 | 0.05 | |
| 3 | $A^{03} = \{6, 7, 13, 14, 15\}$ | 0.30 | 0.00 | |
| 4 | $A^{04} = \{6, 7, 8, 14, 15\}$ | 0.21 | 0.00 | ★ |
| 5 | $A^{05} = \{6, 7, 8, 13, 15\}$ | 0.22 | 0.00 | |
| 6 | $A^{06} = \{6, 7, 8, 13, 14\}$ | 0.00 | 0.43 | |

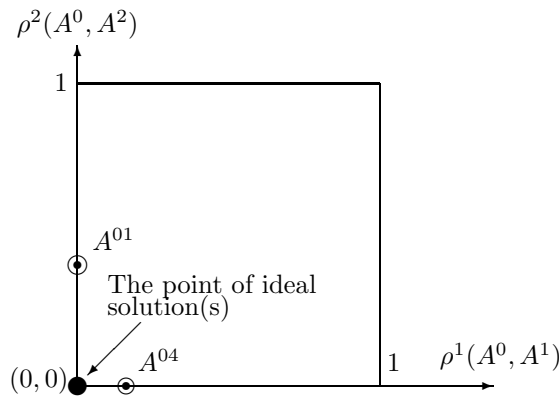

Fig. 8.20. Pareto-efficient solutions

The resultant (extended) Pareto-efficient solutions \widehat{A}^{01} and \widehat{A}^{04} are presented in Fig. 8.21 and in Fig. 8.22 (normal versions of course components are used).

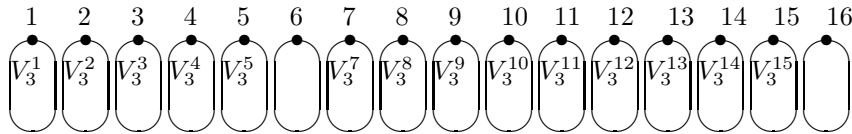

Fig. 8.21. Median-based aggregated common course \widehat{A}^{01}

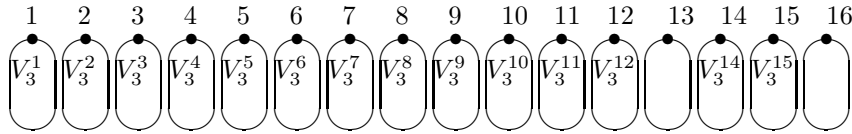

Fig. 8.22. Median-based aggregated common course \widehat{A}^{04}

8.6. Plan of Students Art Activity. The considered numerical example is a small part of the example of students plan from [101]. The initial morphological structure is the following (Fig. 8.23):

1. Plan of students art activity $S = I \star J \star U$:
 - 1.1 dance I : I_1 (none), I_2 (ball dance), I_3 (ensemble);
 - 1.2 music J : J_1 (none), J_2 (classic), J_3 (jazz), J_4 (singing);

1.3 theatre U : U_1 (none), U_2 (actor), U_3 (producer), U_4 (technical worker), U_5 (author).

The following criteria were used for assessment of the design alternatives: cost C_1 , opportunity to meet new friends C_2 , opportunity to meet boy friend or girl friend C_3 , accordance to personal inclinations C_4 , usefulness for future career C_5 , usefulness for health C_6 , and usefulness for future life C_7 . The resultant priorities of design alternatives (via Electre-like technique) are shown in parentheses (Fig. 60). Thus, three resultant solutions are the following (via HMMD):

$$S_1 = I_2 \star J_3 \star U_2, S_2 = I_3 \star J_3 \star U_2, \text{ and } S_3 = I_3 \star J_2 \star U_5.$$

In Fig. 8.24 and Fig. 8.25, supersolution and subsolution are depicted. Note, the subsolution contains only one element. Thus, the design of “system kernel” is based on the special method with $\alpha = 0.6$ (Fig. 8.26). Finally, the obtained “system kernel” K can be considered as the resultant solution.

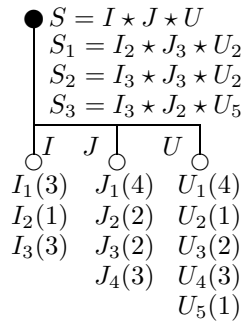

Fig. 8.23. Basic hierarchy

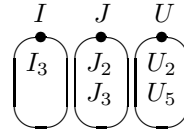

Fig. 8.24. Supersolution $\bar{\Theta}$

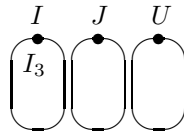

Fig. 8.25. Subsolution $\tilde{\Theta}$

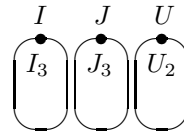

Fig. 8.26. “System kernel” K

8.7. **Combinatorial Investment.** The considered numerical example was presented in [101]. The initial morphological structure is the following (Fig. 8.27):

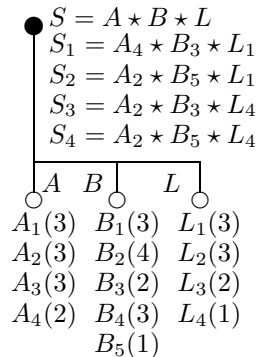

Fig. 8.27. Basic hierarchy

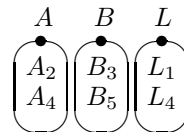

Fig. 8.28. Supersolution $\bar{\Theta}$

1. composite portfolio $S = A \star B \star L$:

1.1 short-time investment A : A_1 (state bonds), A_2 (bank deposit), A_3 (speculation on the stock exchange), A_4 (oil shares);

1.2 middle-time investment B : B_1 (state bonds), B_2 (bank deposit), B_3 (immovables), B_4 (jewelry), B_5 (shares in biotechnology);

1.3 long-time investment L : L_1 (state bonds), L_2 (bank deposit), L_3 (antique), L_4 (shares of airspace companies).

The following criteria were used for assessment of the design alternatives: possible profit Υ_1 , risk Υ_2 , prestige Υ_3 , possibility for continuation Υ_4 , possibility to establish a new company Υ_5 , obtaining a new experience Υ_6 , possibility to organize a new market Υ_7 , possibility to obtain “name” Υ_8 , and connection with previous activity Υ_9 .

The resultant priorities of design alternatives (via Electre-like technique) are shown in parentheses (Fig. 8.27). Thus, four resultant solutions are the following (via HMMD):

$$S_1 = A_4 \star B_3 \star L_1, S_2 = A_2 \star B_5 \star L_1, S_3 = A_2 \star B_3 \star L_4, \text{ and } S_4 = A_2 \star B_5 \star L_4.$$

In Fig. 8.28 and Fig. 8.29, supersolution and subsolution are depicted. Note, the subsolution does not contain elements (empty). Thus, the design of “system kernel” is based on the special method with $\alpha = 0.6$ and selection of the best elements for system parts: B_5 for components B and L_4 for components L (Fig. 8.30). Finally, the obtained “system kernel” K can be considered as the resultant solution.

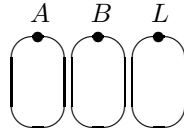

Fig. 8.29. Subsolution $\tilde{\Theta}$

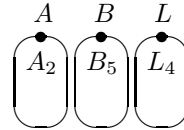

Fig. 8.30. “System kernel” K

8.8. **Configuration of Applied Web-based Information System.** Here aggregation of solution for applied Web-based information system is considered [114]. The tree-like model of the system is depicted in Fig. 8.31.

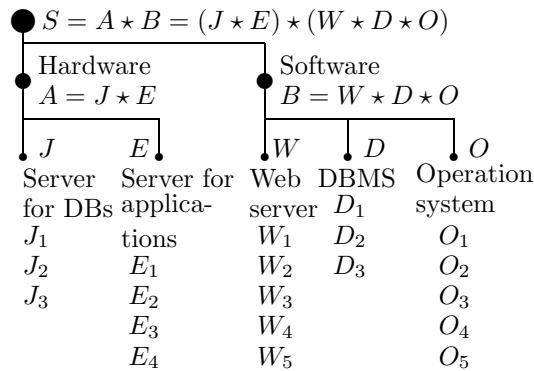

Fig. 8.31. Structure of Web-based system [114]

DAs for system components are the following [114]:

- (1) server for DBs J : PC (J_1), Supermicro (J_2), and Sun (J_3);
- (2) server for applications E : on server of DBs (E_1), Sun (E_2), Supermicro (E_3), and PC (E_4);

(3) Web-server W : Apache HTTP-server (W_1), Microsoft IIS (W_2), Bea Weblogic (W_3), Web Sphere (W_4), and Weblogic cluster (W_5);

(4) DBMS D : Oracle (D_1), Microsoft SQL (D_2), and designed SQL (D_3); and

(5) operation system O : Windows 2000 server (O_1), Windows 2003 (O_2), Solaris (O_3), FreeBSD (O_4), and RHEL AS (O_5).

In [114], the design problem was solved for three basic applied situations: (a) communication provider (Fig. 8.32), (b) corporate application (Fig. 8.33), and (c) academic application (Fig. 8.34).

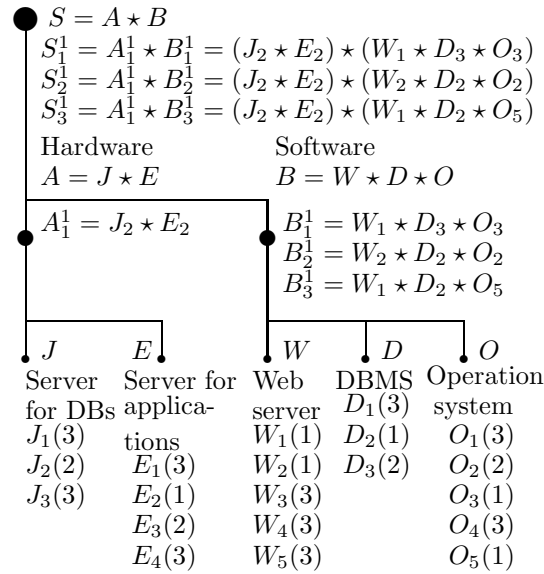

Fig. 8.32. Communication provider [114]

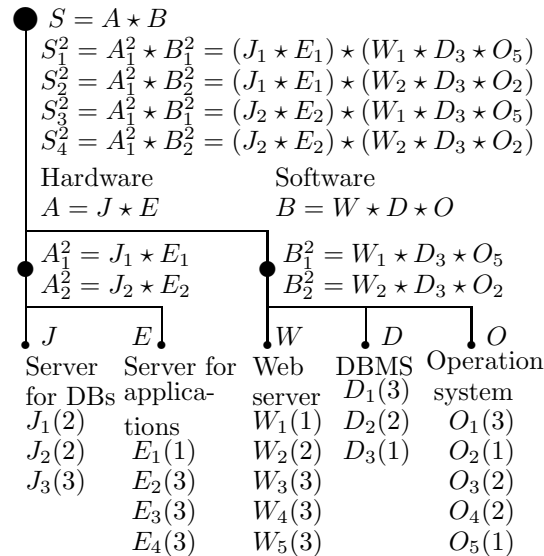

Fig. 8.33. Corporate application [114]

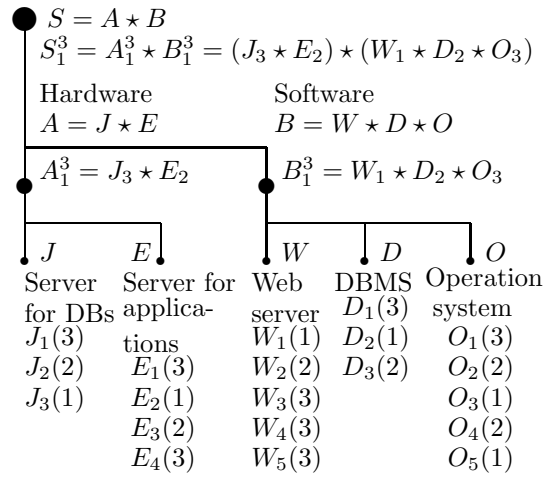

Fig. 8.34. Academic application [114]

Now let us consider an aggregation problem:

To obtain an aggregated solution while taking into account all three application situations.

Here two simplified heuristic solving strategies are examined:

- (i) aggregation of composite solutions for three considered cases;
- (ii) aggregation of information at the first stage of the solving process (aggregation of rankings for DAs of system components J, E, W, D, O) and usage of HMMD to solve the design problem.

Let us describe the first strategy. Here the solving process is based on median/kernel-based strategy (Fig. 8.35). The resultant solution is (an approximate median/kernel):

$$S = (J_2 \star E_2) \star (W_1 \star D_3 \star O_2).$$

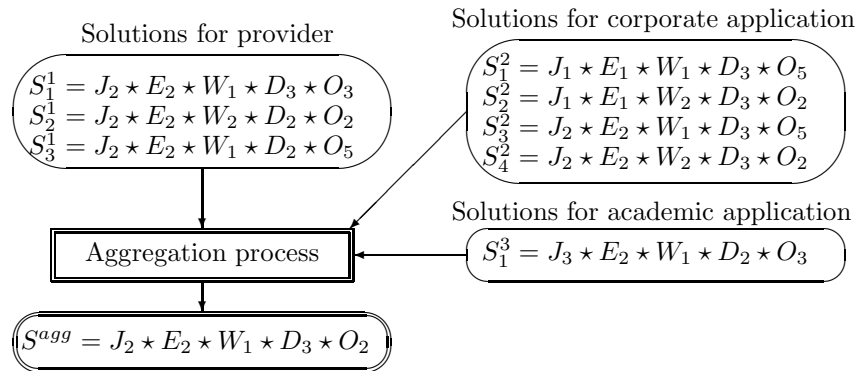
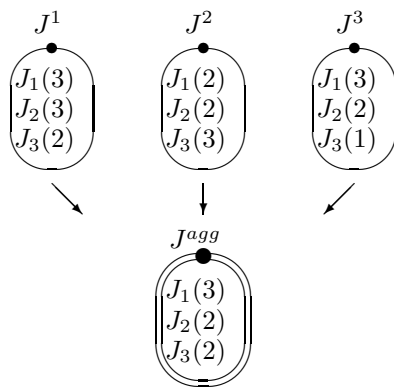
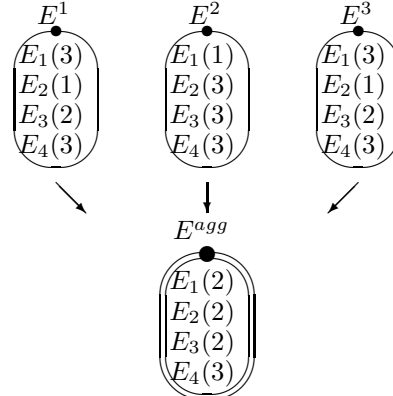
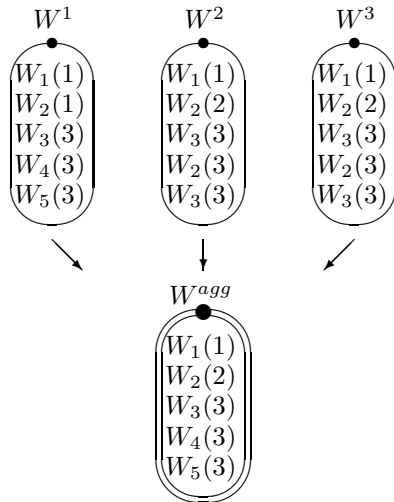
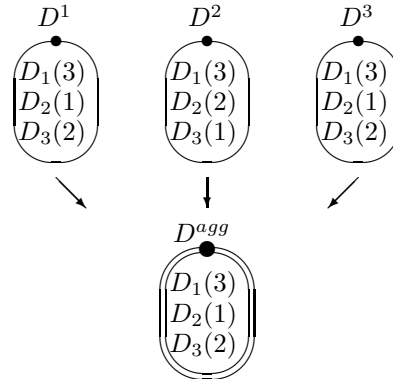
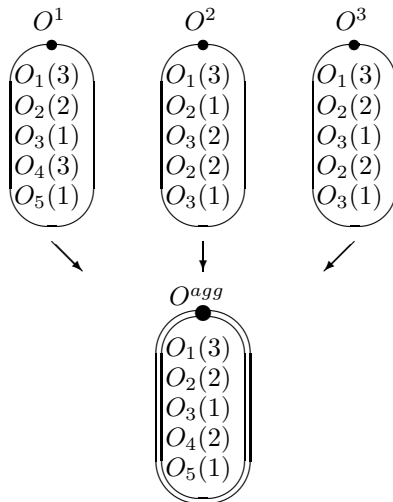

Fig. 8.35. Aggregation of solutions

The second solving strategy is based on preliminary aggregation of rankings (Fig. 8.36, Fig. 8.37, Fig. 8.38, Fig. 8.39, Fig. 8.40) and a new design.

Fig. 8.36. Aggregation for J Fig. 8.37. Aggregation for E Fig. 8.38. Aggregation for W Fig. 8.39. Aggregation for D Fig. 8.40. Aggregation for O

After the usage of HMMD for the aggregated rankings of DAs (for system components J, E, W, D, O), the following four resultant composite DAs are obtained (Fig. 8.41, compatibility estimates are contained in [114]):

- (a) $S_1^{agg} = A_1 \star B_1 = (J_2 \star E_2) \star (W_1 \star D_2 \star O_5)$,
- (b) $S_2^{agg} = A_1 \star B_2 = (J_2 \star E_2) \star (W_1 \star D_3 \star O_5)$,
- (c) $S_3^{agg} = A_2 \star B_1 = (J_3 \star E_2) \star (W_1 \star D_2 \star O_5)$, and
- (d) $S_4^{agg} = A_2 \star B_2 = (J_3 \star E_2) \star (W_1 \star D_3 \star O_5)$.

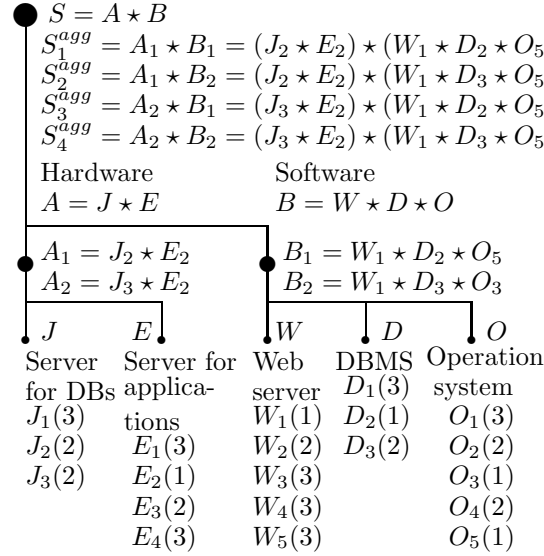

Fig. 8.41. Aggregation as design (2nd strategy)

8.9. Modular Educational Course on Design. Here aggregation of three educational courses (morphological structures) is examined: (1) course on systems engineering (structure Λ^1) ([101], [102]) (Fig. 8.42); (2) course on information engineering (structure Λ^2) ([99], [101]) (Fig. 8.43); and (3) course on hierarchical design (structure Λ^3) ([101], [106], [113]) (Fig. 8.44). The following general types DAs (i.e., of the corresponding educational module) are examined for each leaf node of the presented hierarchical models (Fig. 8.42, Fig. 8.43, and Fig. 8.44): “absence” of the educational module X_0 , compressed information on the educational module X_1 , teaching at a medium level X_2 , serious teaching X_3 , and serious teaching with a special student research work/project X_4 . Compatibility estimates for three examined morphological structures above are presented in Tables (expert judgment): (i) structure Λ^1 : Table 8.12, Table 8.13; (ii) structure Λ^2 : Table 8.14, Table 8.15, Table 8.16; and (iii) structure Λ^3 : Table 8.17, Table 8.18, Table 8.19.

After usage of HMMD, the following composite DAs are obtained:

I. For structure Λ^1 (Fig. 8.42):

$$D_1 = L_3 \star G_2 \star C_2 \star M_2, N(D_1) = (2; 3, 0, 1),$$

$$D_2 = L_4 \star G_2 \star C_1 \star M_2, N(D_2) = (1; 2, 2, 0);$$

$$Q_1 = A_3 \star B_2, N(Q_1) = (3; 2, 0, 0), Q_2 = A_4 \star B_4, N(Q_2) = (3; 2, 0, 0);$$

$$S_1^1 = D_1 \star Q_1 = (L_3 \star G_2 \star C_2 \star M_2) \star (A_3 \star B_3),$$

$$S_2^1 = D_1 \star Q_2 = (L_3 \star G_2 \star C_2 \star M_2) \star (A_4 \star B_4),$$

$$S_3^1 = D_2 \star Q_1 = (L_4 \star G_2 \star C_1 \star M_2) \star (A_3 \star B_3),$$

$$S_4^1 = D_2 \star Q_2 = (L_4 \star G_2 \star C_1 \star M_2) \star (A_4 \star B_4).$$

II. For structure Λ^2 (Fig. 8.43):

$$I_1 = L_3 \star G_2 \star C_2 \star E_2, N(I_1) = (3; 2, 1, 0);$$

$$O_1 = H_3 \star W_2 \star M_2, N(O_1) = (2; 3, 0, 0), O_2 = H_2 \star W_2 \star M_2, N(O_2) = (3; 2, 1, 0);$$

$$Q_1 = V_3 \star J_3 \star Y_2 \star R_3, N(Q_1) = (3; 4, 0, 0);$$

$$S_1^2 = I_1 \star O_1 \star Q_1 = (G_2 \star C_2 \star E_2) \star (H_3 \star W_2 \star M_2) \star (V_3 \star J_3 \star Y_2 \star R_3),$$

$$S_2^2 = I_1 \star O_2 \star Q_1 = (G_2 \star C_2 \star E_2) \star (H_2 \star W_2 \star M_2) \star (V_3 \star J_3 \star Y_2 \star R_3).$$

III. For structure Λ^3 (Fig. 8.44):

$$I_1 = G_2 \star C_2, N(I_1) = (3; 2, 0, 0);$$

$$O_1 = H_2 \star W_2 \star M_2 \star U_1, N(O_1) = (3; 3, 1, 0),$$

$$O_2 = H_3 \star W_2 \star M_2 \star U_1, N(O_2) = (2; 4, 0, 0);$$

$$Q_1 = F_4 \star J_1 \star Y_2 \star Z_3, N(Q_1) = (3; 3, 1, 0);$$

$$S_1^3 = I_1 \star O_1 \star Q_1 = (G_2 \star C_2) \star (H_2 \star W_2 \star M_2 \star U_1) \star (F_4 \star J_1 \star Y_2 \star Z_3),$$

$$S_2^3 = I_1 \star O_2 \star Q_1 = (G_2 \star C_2) \star (H_3 \star W_2 \star M_2 \star U_1) \star (F_4 \star J_1 \star Y_2 \star Z_3).$$

Evidently, it is possible to aggregate the obtained composite solutions (Fig. 8.45).

On the other hand, let us consider the following extended aggregation strategy IV. General structure (Λ) consists of the following parts: (i) tree-like system model \mathbf{T} , (ii) set of leaf nodes \mathbf{P} , (iii) sets of DAs for each leaf node \mathbf{D} , (iv) DAs rankings (i.e., ordinal priorities) \mathbf{R} , and (v) compatibility estimates between DAs \mathbf{I} . Thus, a vector proximity for two structures $\Lambda^\alpha, \Lambda^\beta$ can be examined as follows:

$$\bar{\rho}(\Lambda^\alpha, \Lambda^\beta) = (\rho^t(\mathbf{T}^\alpha, \mathbf{T}^\beta), \rho^t(\mathbf{P}^\alpha, \mathbf{P}^\beta), \rho^t(\mathbf{D}^\alpha, \mathbf{D}^\beta), \rho^t(\mathbf{R}^\alpha, \mathbf{R}^\beta), \rho^t(\mathbf{I}^\alpha, \mathbf{I}^\beta)).$$

As a result, Λ^{agg} has to be searched for as Pareto-efficient solution(s) by the vectors $\bar{\rho}(\Lambda^{agg}, \Lambda^i) \forall i \in \{i\}$ where index i corresponds to an initial solution. This problem is very complicated. Let us consider a simplified solving framework:

Phase 1. Aggregation of basic initial data for initial structures:

1.1. aggregation of morphological structures including the following:

(1.1.1.) aggregation of sets of leaf nodes,

(1.1.2.) aggregation of sets of DAs for each leaf node,

(1.1.3.) aggregation of DAs rankings, and

(1.1.4.) aggregation of compatibility estimates for DAs sets;

1.2. aggregation tree-like structures.

Phase 2. New hierarchical design.

Thus, the following stages are considered for examined three structures $(\Lambda^1, \Lambda^2, \Lambda^3)$:

Stage 1. Aggregation of leaf node sets for the initial structures (Fig. 8.46);

Stage 2. Aggregation of morphological structure:

2.1. aggregation of sets of DAs for each leaf node (by each leaf node (while taking into account addition of DAs which correspond to “absence”, i.e., aggregation of rankings with extension of DAs sets) (Fig. 8.47, Fig. 8.48, Fig. 8.49, Fig. 8.50, Fig. 8.51, Fig. 8.52, Fig. 8.53, Fig. 8.54, Fig. 8.55, Fig. 8.56, Fig. 8.57, Fig. 8.58, Fig. 8.59, Fig. 8.60, Fig. 8.61, Fig. 8.62);

2.2. aggregation of interconnection (compatibility estimates) for DAs sets (Tables 8.20, 8.21, 8.22, 8.23; selection of a maximal value or expert judgment);

Stage 3. Building of an aggregation tree-like structure (Fig. 8.63); and

Stage 4. Hierarchical design of an integrated course (as an aggregated solution) (Fig. 8.63).

Here the aggregated superstructure $\bar{\Lambda}$ (Fig. 8.63) has been obtained via expert judgment.

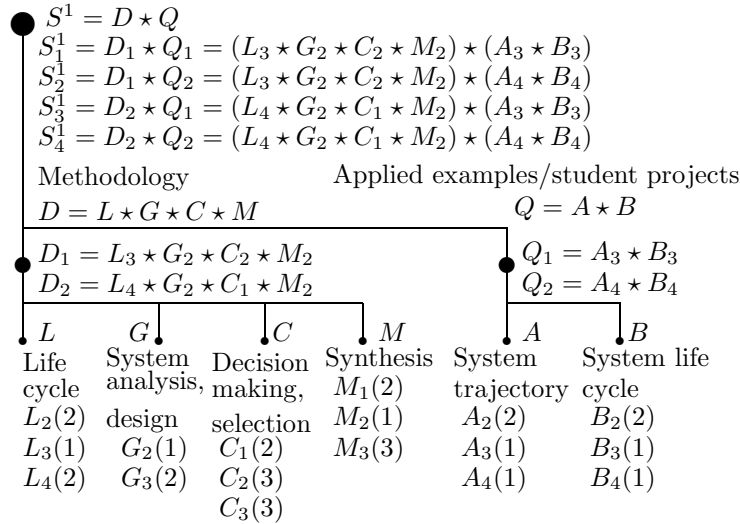

Fig. 8.42. Course on systems engineering (structure Λ^1)

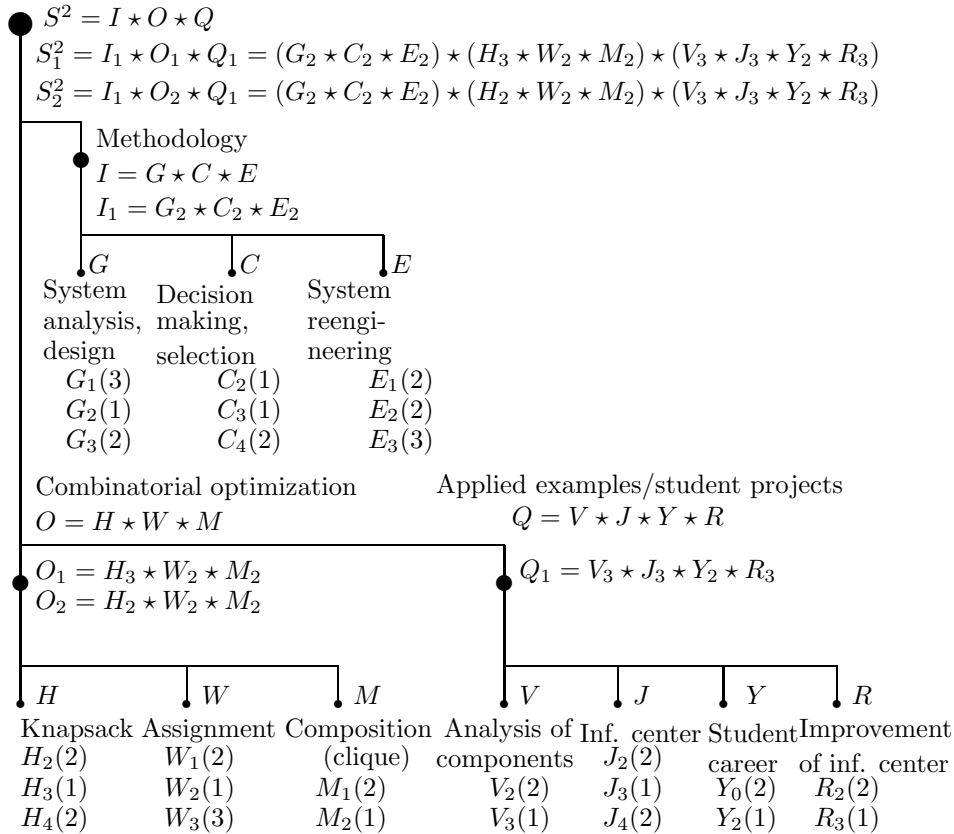

Fig. 8.43. Course on information system (structure Λ^2)

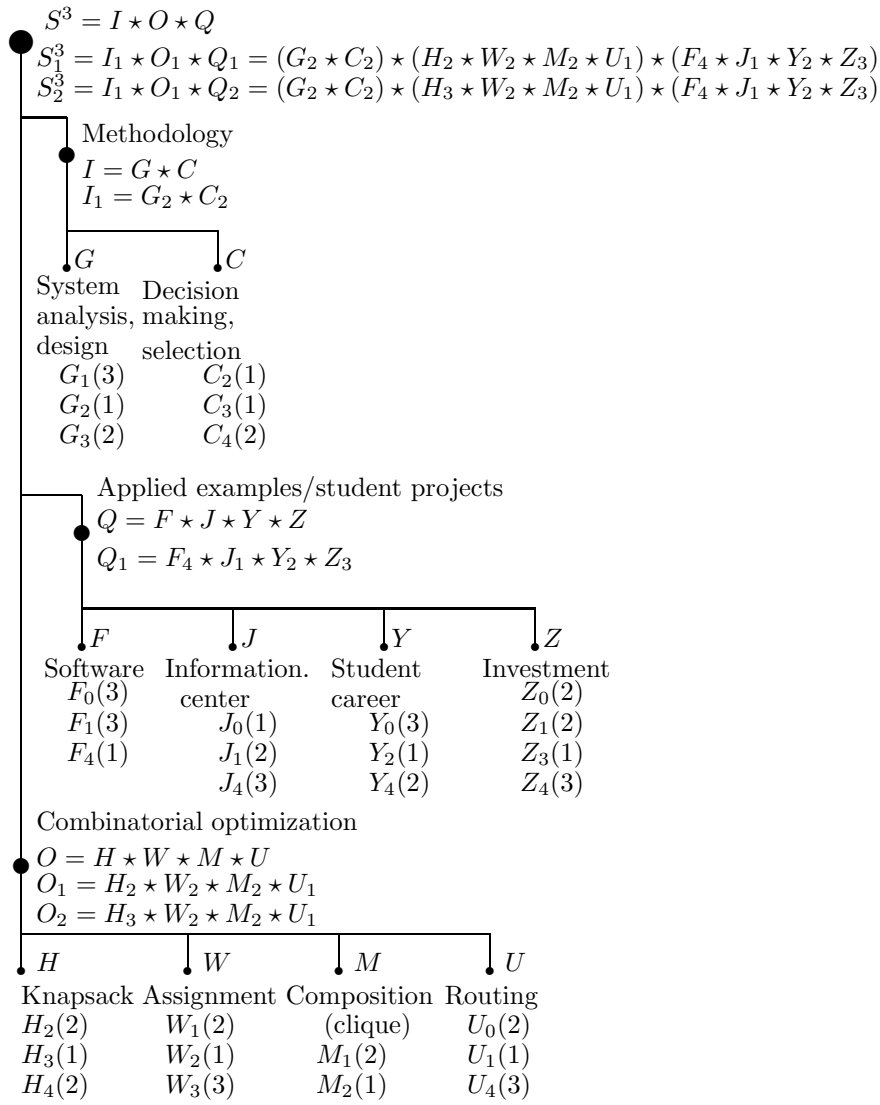

Fig. 8.44. Course on hierarchical design (structure Λ^3)

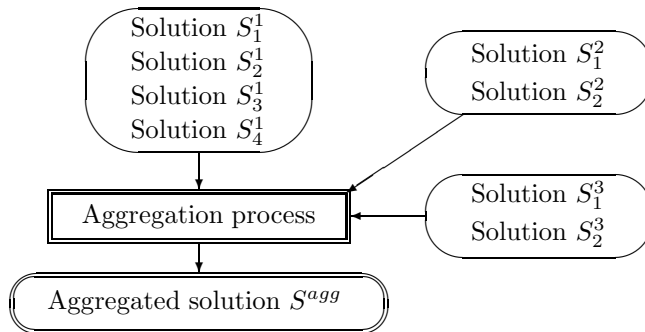

Fig. 8.45. Aggregation of solutions

Table 8.12. Compatibility

| | G_2 | G_3 | C_1 | C_2 | C_3 | M_1 | M_2 | M_3 |
|-------|-------|-------|-------|-------|-------|-------|-------|-------|
| L_2 | 2 | 0 | 3 | 2 | 0 | 3 | 2 | 0 |
| L_3 | 2 | 3 | 0 | 2 | 2 | 1 | 3 | 2 |
| L_4 | 1 | 3 | 0 | 3 | 3 | 0 | 2 | 3 |
| G_2 | | | 1 | 3 | 2 | 1 | 3 | 2 |
| G_3 | | | 0 | 2 | 3 | 0 | 2 | 3 |
| C_1 | | | | | | 3 | 1 | 0 |
| C_2 | | | | | | 1 | 3 | 1 |
| C_3 | | | | | | 0 | 2 | 3 |

Table 8.13. Compatibility

| | B_2 | B_3 | B_4 |
|-------|-------|-------|-------|
| A_2 | 3 | 2 | 1 |
| A_3 | 2 | 3 | 2 |
| A_4 | 1 | 2 | 3 |

Table 8.14. Compatibility

| | C_2 | C_3 | C_4 | E_1 | E_2 | E_3 |
|-------|-------|-------|-------|-------|-------|-------|
| G_1 | 2 | 1 | 0 | 3 | 1 | 0 |
| G_2 | 3 | 0 | 1 | 1 | 3 | 2 |
| G_3 | 0 | 3 | 3 | 0 | 2 | 3 |
| C_2 | | | | 3 | 3 | 0 |
| C_3 | | | | 3 | 3 | 3 |
| C_4 | | | | 0 | 2 | 3 |

Table 8.15. Compatibility

| | W_1 | W_2 | W_3 | M_1 | M_2 |
|-------|-------|-------|-------|-------|-------|
| H_2 | 3 | 3 | 2 | 3 | 3 |
| H_3 | 1 | 2 | 3 | 1 | 3 |
| H_4 | 0 | 2 | 3 | 0 | 3 |
| W_1 | | | | 3 | 2 |
| W_2 | | | | 3 | 3 |
| W_3 | | | | 3 | 3 |

Table 8.16. Compatibility

| | J_2 | J_3 | J_4 | Y_0 | Y_2 | R_2 | R_3 |
|-------|-------|-------|-------|-------|-------|-------|-------|
| V_2 | 3 | 2 | 2 | 3 | 3 | 3 | 3 |
| V_3 | 2 | 3 | 3 | 3 | 3 | 3 | 3 |
| J_2 | | | | 3 | 2 | 3 | 2 |
| J_3 | | | | 3 | 3 | 2 | 3 |
| J_4 | | | | 3 | 3 | 2 | 3 |
| Y_0 | | | | | | 2 | 2 |
| Y_2 | | | | | | 2 | 3 |

Table 8.17. Compatibility

| | C_2 | C_3 | C_4 |
|-------|-------|-------|-------|
| G_1 | 2 | 1 | 0 |
| G_2 | 3 | 0 | 1 |
| G_3 | 0 | 3 | 3 |

Table 8.18. Compatibility

| | J_0 | J_1 | J_4 | Y_0 | Y_2 | Y_4 | Z_0 | Z_1 | Z_3 | Z_4 |
|-------|-------|-------|-------|-------|-------|-------|-------|-------|-------|-------|
| F_0 | 3 | 1 | 1 | 3 | 1 | 0 | 3 | 2 | 2 | 0 |
| F_1 | 0 | 3 | 3 | 0 | 3 | 3 | 1 | 3 | 3 | 3 |
| F_4 | 0 | 3 | 3 | 0 | 3 | 3 | 0 | 2 | 3 | 3 |
| J_0 | | | | 3 | 1 | 0 | 3 | 2 | 2 | 0 |
| J_1 | | | | 0 | 3 | 3 | 1 | 3 | 3 | 3 |
| J_4 | | | | 0 | 3 | 3 | 0 | 2 | 3 | 3 |
| Y_0 | | | | | | | 3 | 2 | 2 | 0 |
| Y_2 | | | | | | | 1 | 3 | 3 | 3 |
| Y_4 | | | | | | | 0 | 2 | 3 | 3 |

Table 8.19. Compatibility

| | W_1 | W_2 | W_3 | M_1 | M_2 | U_0 | U_1 | U_4 |
|-------|-------|-------|-------|-------|-------|-------|-------|-------|
| H_2 | 3 | 3 | 2 | 3 | 3 | 3 | 3 | 3 |
| H_3 | 1 | 2 | 3 | 1 | 3 | 3 | 3 | 3 |
| H_4 | 0 | 2 | 3 | 0 | 3 | 3 | 3 | 3 |
| W_1 | | | | 3 | 2 | 3 | 2 | 2 |
| W_2 | | | | 3 | 3 | 2 | 3 | 0 |
| W_3 | | | | 3 | 3 | 2 | 2 | 3 |
| M_1 | | | | | | 1 | 3 | 3 |
| M_2 | | | | | | 1 | 3 | 3 |

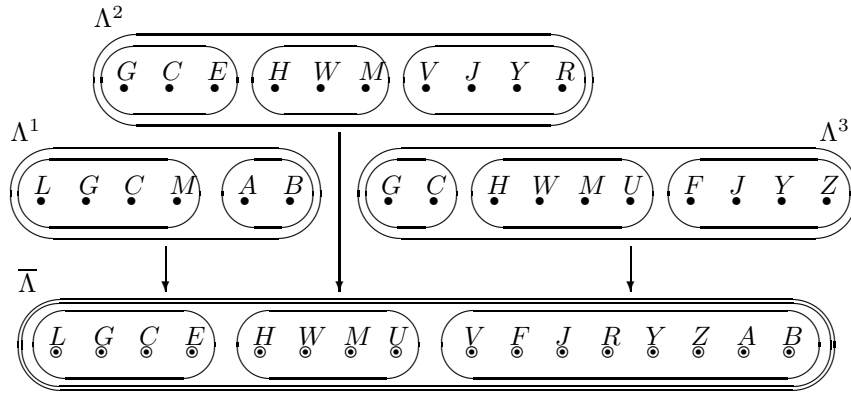

Fig. 8.46. Aggregation of leaf node sets

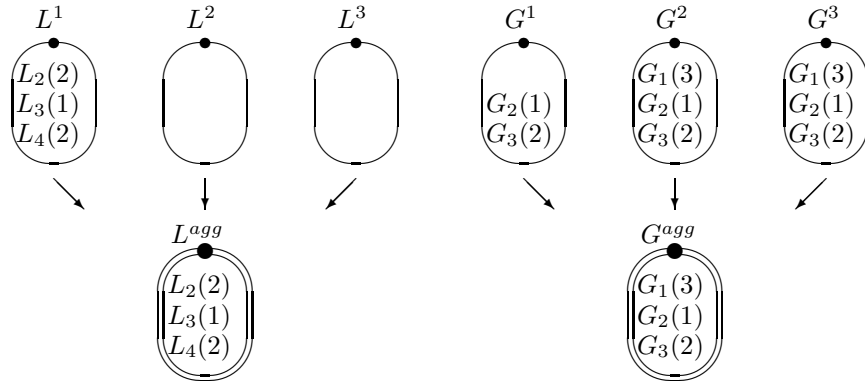

Fig. 8.47. Aggregation for L

Fig. 8.48. Aggregation for G

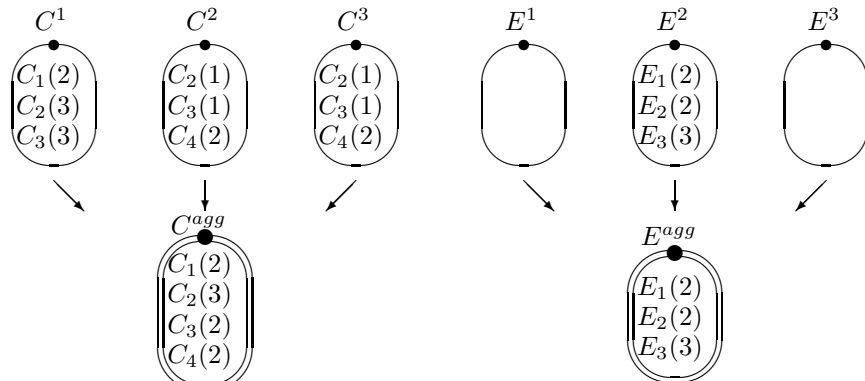

Fig. 8.49. Aggregation for C

Fig. 8.50. Aggregation for E

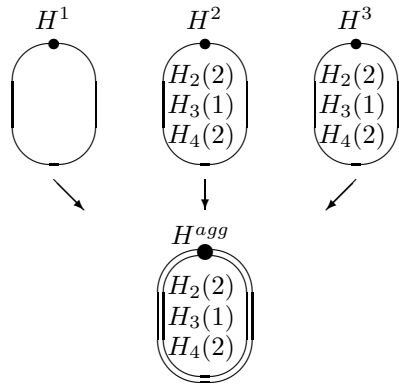

Fig. 8.51. Aggregation for H

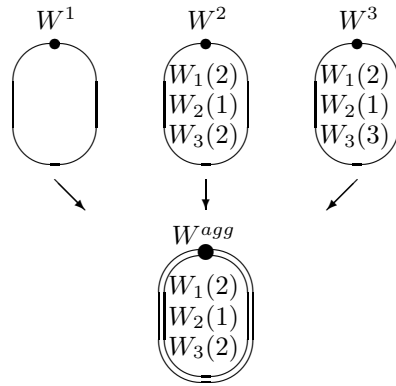

Fig. 8.52. Aggregation for W

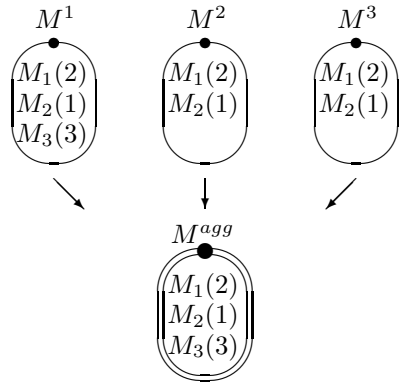

Fig. 8.53. Aggregation for M

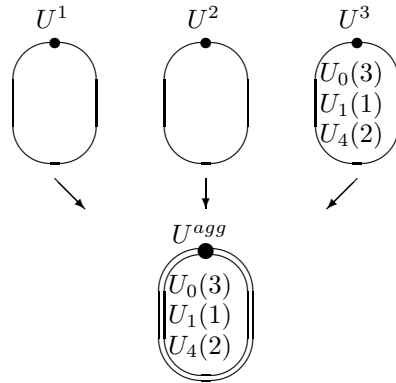

Fig. 8.54. Aggregation for U

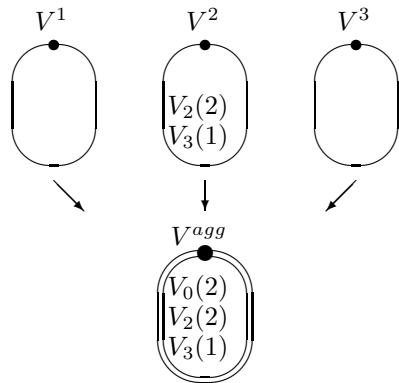

Fig. 8.55. Aggregation for V

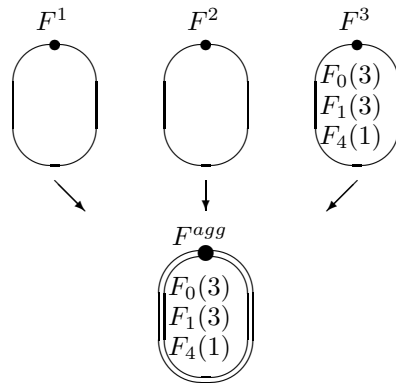
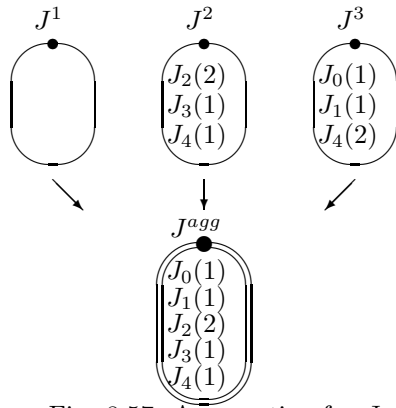
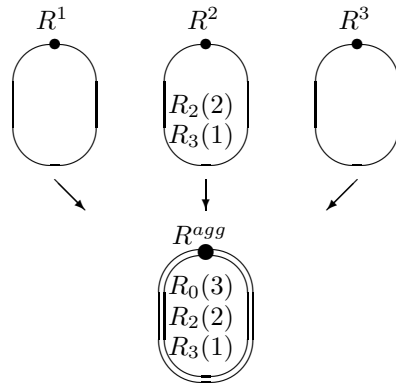
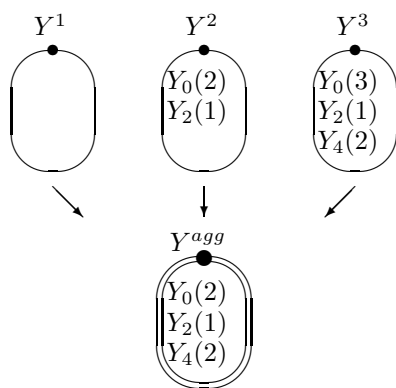
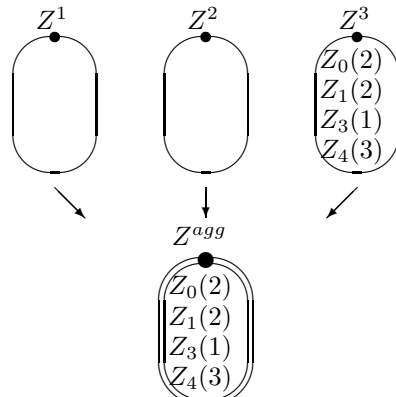
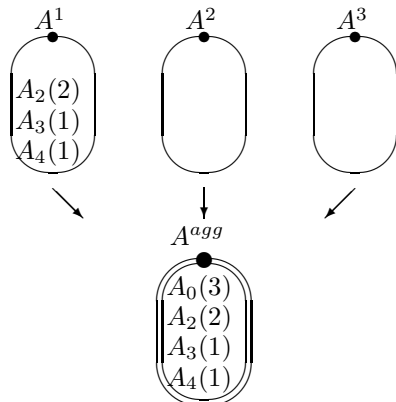
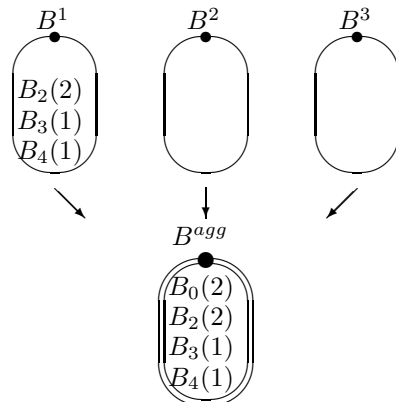

Fig. 8.56. Aggregation for F

Fig. 8.57. Aggregation for J Fig. 8.58. Aggregation for R Fig. 8.59. Aggregation for Y Fig. 8.60. Aggregation for Z Fig. 8.61. Aggregation for A Fig. 8.62. Aggregation for B

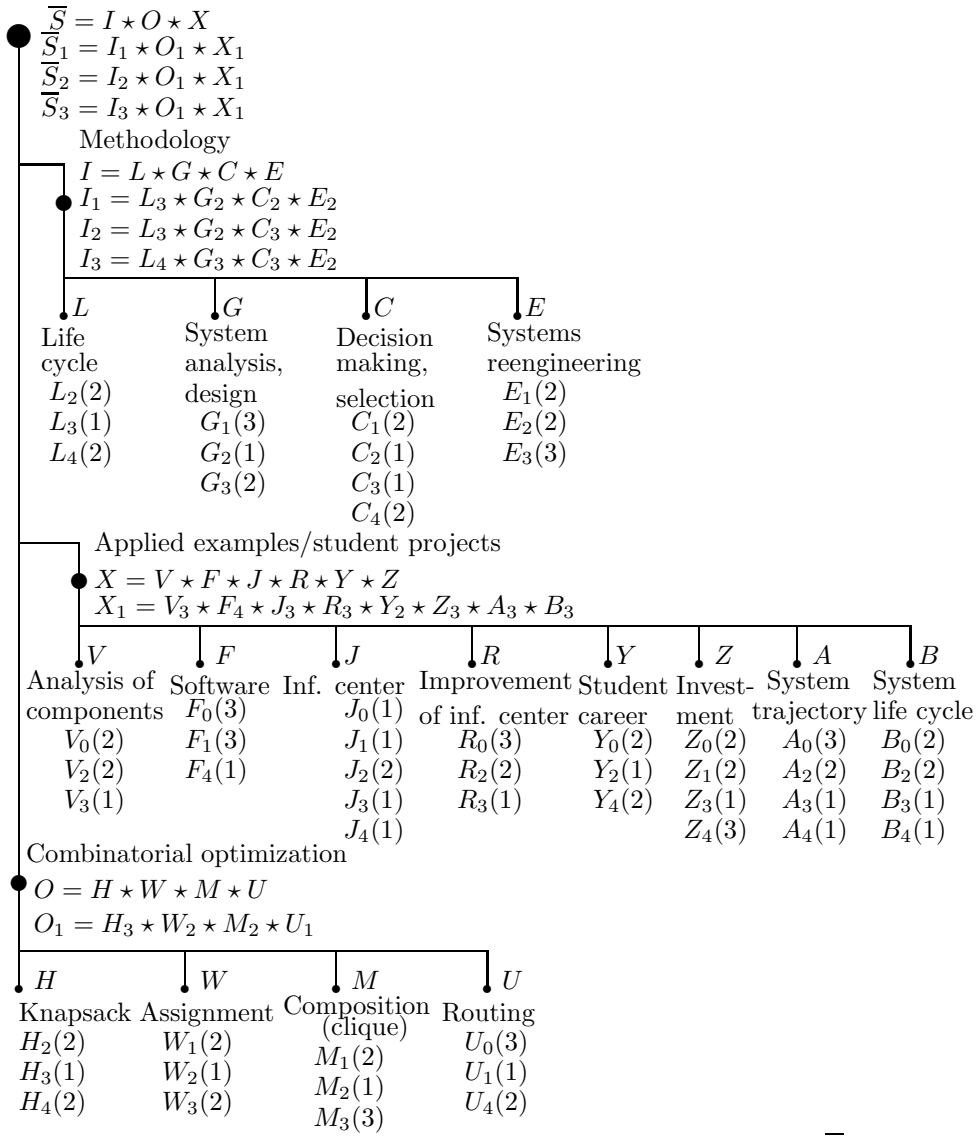

Fig. 8.63. Superstructure for aggregated course (structure $\bar{\Lambda}$)

Table 8.20. Compatibility

| | W_1 | W_2 | W_3 | M_1 | M_2 | M_3 | U_0 | U_1 | U_4 |
|-------|-------|-------|-------|-------|-------|-------|-------|-------|-------|
| H_2 | 3 | 3 | 2 | 3 | 3 | 3 | 3 | 3 | 3 |
| H_3 | 1 | 2 | 3 | 1 | 3 | 3 | 3 | 3 | 3 |
| H_4 | 0 | 2 | 3 | 0 | 3 | 3 | 3 | 3 | 3 |
| W_1 | | | | 3 | 2 | 2 | 3 | 2 | 2 |
| W_2 | | | | 3 | 3 | 3 | 2 | 2 | 2 |
| W_3 | | | | 3 | 3 | 3 | 2 | 2 | 3 |
| M_1 | | | | | | | 1 | 0 | 2 |
| M_2 | | | | | | | 0 | 3 | 3 |
| M_3 | | | | | | | 0 | 2 | 3 |

Table 8.21. Compatibility

| | G_1 | G_2 | G_3 | C_1 | C_2 | C_3 | C_4 | E_1 | E_2 | E_3 |
|-------|-------|-------|-------|-------|-------|-------|-------|-------|-------|-------|
| L_2 | 2 | 2 | 0 | 3 | 2 | 1 | 0 | 3 | 2 | 1 |
| L_3 | 1 | 2 | 3 | 0 | 2 | 2 | 2 | 1 | 3 | 3 |
| L_4 | 0 | 1 | 3 | 0 | 3 | 3 | 3 | 1 | 3 | 3 |
| G_1 | | | | 0 | 2 | 1 | 0 | 3 | 1 | 0 |
| G_2 | | | | 1 | 3 | 2 | 3 | 1 | 2 | 2 |
| G_3 | | | | 0 | 2 | 3 | 3 | 0 | 3 | 3 |
| C_1 | | | | | | | | 3 | 1 | 0 |
| C_2 | | | | | | | | 3 | 3 | 0 |
| C_3 | | | | | | | | 3 | 3 | 3 |
| C_4 | | | | | | | | 0 | 2 | 3 |

Table 8.22. Compatibility

| | F_0 | F_1 | F_4 | J_0 | J_1 | J_2 | J_3 | J_4 |
|-------|-------|-------|-------|-------|-------|-------|-------|-------|
| V_0 | 3 | 1 | 1 | 3 | 1 | 1 | 0 | 0 |
| V_2 | 2 | 3 | 3 | 1 | 1 | 3 | 2 | 2 |
| V_3 | 2 | 2 | 3 | 1 | 2 | 2 | 3 | 3 |
| F_0 | | | | 3 | 1 | 1 | 1 | 1 |
| F_1 | | | | 1 | 3 | 3 | 3 | 3 |
| F_4 | | | | 1 | 3 | 3 | 3 | 3 |

Table 8.23. Compatibility

| | R_0 | R_2 | R_3 | Y_0 | Y_2 | Y_4 | Z_0 | Z_1 | Z_3 | Z_4 | A_0 | A_2 | A_3 | A_4 | B_0 | B_2 | B_3 | B_4 |
|-------|-------|-------|-------|-------|-------|-------|-------|-------|-------|-------|-------|-------|-------|-------|-------|-------|-------|-------|
| V_0 | 0 | 1 | 1 | 0 | 1 | 1 | 0 | 0 | 1 | 1 | 0 | 1 | 1 | 0 | 0 | 1 | 1 | 0 |
| V_2 | 1 | 3 | 3 | 3 | 3 | 3 | 1 | 2 | 3 | 3 | 0 | 3 | 2 | 2 | 0 | 3 | 2 | 2 |
| V_3 | 1 | 3 | 3 | 3 | 3 | 3 | 1 | 2 | 3 | 3 | 0 | 1 | 3 | 3 | 0 | 1 | 3 | 3 |
| F_0 | 0 | 0 | 1 | 3 | 1 | 0 | 3 | 2 | 2 | 0 | 0 | 1 | 1 | 0 | 0 | 1 | 1 | 0 |
| F_1 | 0 | 2 | 2 | 0 | 3 | 3 | 1 | 3 | 3 | 3 | 0 | 1 | 2 | 2 | 0 | 1 | 2 | 2 |
| F_4 | 1 | 3 | 3 | 0 | 3 | 3 | 0 | 2 | 3 | 3 | 1 | 1 | 3 | 3 | 1 | 1 | 3 | 3 |
| J_0 | 0 | 1 | 0 | 0 | 1 | 0 | 3 | 2 | 2 | 0 | 0 | 1 | 1 | 0 | 0 | 1 | 1 | 0 |
| J_1 | 0 | 2 | 2 | 1 | 1 | 2 | 1 | 3 | 3 | 3 | 0 | 3 | 2 | 1 | 0 | 3 | 2 | 1 |
| J_2 | 0 | 3 | 2 | 3 | 3 | 3 | 1 | 2 | 3 | 3 | 0 | 3 | 2 | 1 | 0 | 3 | 2 | 1 |
| J_3 | 0 | 2 | 3 | 3 | 3 | 3 | 1 | 2 | 3 | 3 | 1 | 2 | 3 | 2 | 1 | 2 | 3 | 2 |
| J_4 | 0 | 2 | 3 | 3 | 3 | 3 | 0 | 2 | 3 | 3 | 1 | 1 | 2 | 3 | 1 | 1 | 2 | 3 |
| R_1 | | | | 2 | 1 | 1 | 0 | 0 | 1 | 1 | 0 | 1 | 1 | 0 | 0 | 1 | 1 | 0 |
| R_2 | | | | 2 | 3 | 3 | 1 | 2 | 3 | 3 | 0 | 2 | 3 | 3 | 0 | 2 | 3 | 3 |
| R_3 | | | | 2 | 3 | 3 | 1 | 2 | 3 | 3 | 0 | 1 | 3 | 3 | 0 | 1 | 3 | 3 |
| Y_0 | | | | | | | 3 | 2 | 2 | 0 | 0 | 1 | 1 | 0 | 0 | 1 | 1 | 0 |
| Y_2 | | | | | | | 1 | 3 | 3 | 3 | 1 | 2 | 3 | 2 | 1 | 2 | 3 | 2 |
| Y_3 | | | | | | | 0 | 2 | 3 | 3 | 0 | 1 | 2 | 3 | 0 | 1 | 2 | 3 |
| Z_0 | | | | | | | | | | | 0 | 1 | 1 | 0 | 0 | 1 | 1 | 0 |
| Z_1 | | | | | | | | | | | 0 | 3 | 2 | 1 | 0 | 3 | 2 | 1 |
| Z_3 | | | | | | | | | | | 1 | 2 | 3 | 2 | 1 | 2 | 3 | 2 |
| Z_4 | | | | | | | | | | | 0 | 1 | 2 | 3 | 0 | 1 | 2 | 3 |
| A_0 | | | | | | | | | | | | | | | 0 | 1 | 1 | 0 |
| A_2 | | | | | | | | | | | | | | | 0 | 3 | 2 | 1 |
| A_3 | | | | | | | | | | | | | | | 1 | 2 | 3 | 2 |
| A_4 | | | | | | | | | | | | | | | 0 | 1 | 2 | 3 |

After usage of HMMD, the following composite DAs are obtained for the resultant aggregated structure ($\bar{\Lambda}$) (Fig. 8.63):

$$X_1 = V_3 \star F_4 \star J_3 \star R_3 \star Y_2 \star Z_3 \star A_3 \star B_3, N(X_1) = (3; 8, 0, 0),$$

$$O_1 = H_3 \star W_2 \star M_2 \star U_1, N(O_1) = (2; 4, 0, 0);$$

$$I_1 = L_3 \star G_2 \star C_2 \star E_2, N(O_1) = (2; 4, 0, 0),$$

$$I_2 = L_3 \star G_2 \star C_3 \star E_2, N(O_1) = (2; 4, 0, 0),$$

$$I_3 = L_4 \star G_3 \star C_3 \star E_2, N(O_1) = (3; 2, 2, 0);$$

$$\begin{aligned}\bar{S}_1 &= I_1 \star O_1 \star X_1 = (L_3 \star G_2 \star C_2 \star E_2) \star (H_3 \star W_2 \star M_2 \star U_1) \star (V_3 \star F_4 \star J_3 \star \\ &R_3 \star Y_2 \star Z_3 \star A_3 \star B_3), \\ \bar{S}_2 &= I_2 \star O_1 \star X_1 = (L_3 \star G_2 \star C_3 \star E_2) \star (H_3 \star W_2 \star M_2 \star U_1) \star (V_3 \star F_4 \star J_3 \star \\ &R_3 \star Y_2 \star Z_3 \star A_3 \star B_3), \\ \bar{S}_2 &= I_3 \star O_1 \star X_1 = (L_3 \star G_3 \star C_3 \star E_2) \star (H_3 \star W_2 \star M_2 \star U_1) \star (V_3 \star F_4 \star J_3 \star \\ &R_3 \star Y_2 \star Z_3 \star A_3 \star B_3).\end{aligned}$$

8.10. Configuration of Car in Electronic Shopping. Recently, many products have a complex configuration and a buyer can often generate a product configuration that is more useful for him/her. An approach to electronic shopping based on product configuration (morphological approach) has been suggested in [109]. Here let us consider a multi-choice scheme for selection of structured product/system in electronic shopping with a resultant aggregation (Fig. 8.64).

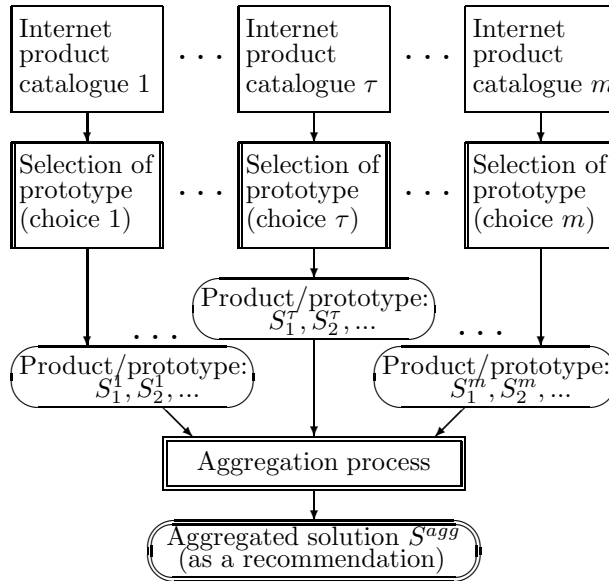

Fig. 8.64. Multi-choice scheme of electronic shopping

Now the following example is described (at a conceptual level). An initial morphological structure Λ of a car is the following (Fig. 8.65) (in real application, this structure can be considered as a result of processing the selected products/solutions):

0. Car $S = A \star B \star C$.

1. Main part $A = E \star D$:

1.1. Engine E : diesel E_1 , gasoline E_2 , electric E_3 , hydrogenous E_4 , and hybrid synergy drive HSD E_5 ;

1.2. Body D : sedan D_1 , universal D_2 , jeep D_3 , pickup D_4 , and sport D_5 .

2. Mechanical part $B = X \star Y \star P \star Z$:

2.1. gear box X : automate X_1 , manual X_2 ;

2.2. suspension Y : pneumatic Y_1 , hydraulic Y_2 , and pneumohydraulic Y_3 ;

2.3. drive P : front-wheel drive P_1 , rear-drive P_2 , all-wheel-drive P_3 .

3. Safety part $C = O \star G$:

3.1. O : "absence" O_0 , electronic O_1 ;

3.2. Safety subsystem G : “absence” G_0 , passive G_1 , active G_2 .

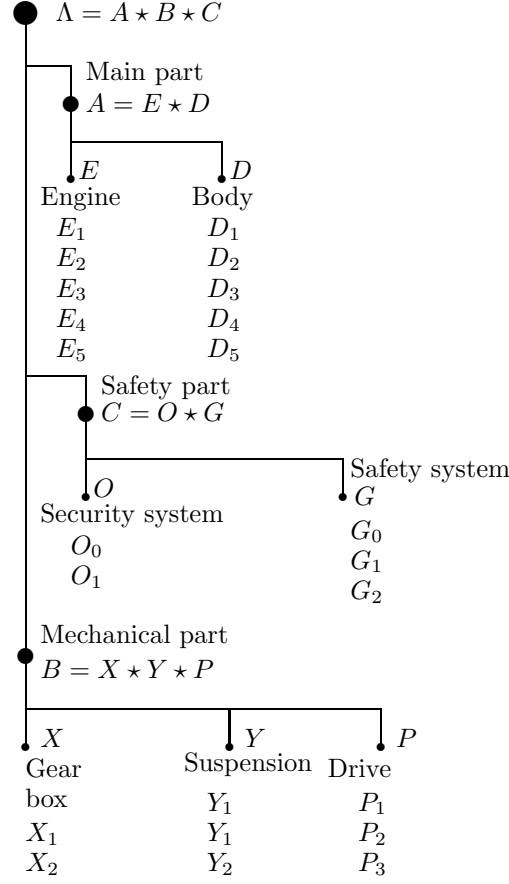

Fig. 8.65. General structure of car Λ

The following initial solutions (obtained by users) are considered:

$$S_1^1 = E_1 * D_1 * X_1 * Y_1 * P_1 * O_1 * G_1, S_2^1 = E_5 * D_1 * X_1 * Y_1 * P_1 * O_1 * G_2,$$

$$S_1^2 = E_2 * D_1 * X_2 * Y_1 * P_1 * O_0 * G_1, S_1^3 = E_2 * D_3 * X_1 * Y_2 * P_3 * O_1 * G_0, \text{ and}$$

$$S_2^3 = E_2 * D_5 * X_1 * Y_3 * P_1 * O_1 * G_1.$$

An aggregated solution can be considered as simplified aggregation of five sets above:

$$S^{agg} = E_2 * D_1 * X_1 * Y_1 * P_1 * O_1 * G_1.$$

9. CONCLUSION

In the article, a systemic view point to aggregation of modular solutions is firstly presented. The aggregation strategies have been suggested and considered: (i) extension strategy (addition of elements to a “system kernel”), (ii) compression strategy (deletion of elements of a superstructure), (iii) combined extension/compression strategy (addition, deletion, and replacement of elements in “system kernel”), and (iv) strategy of a new design (while taking into account new elements). The examined strategies have not been previously discussed in the literature. Our material corresponds to the first step in the investigated domain (aggregation of modular

solutions). The considered aggregation approaches are useful for engineering domains, management, computer science and information technology.

It is necessary to point out, close aggregation problems have been intensive studied and used in several domains: (a) decision making (aggregation of rankings to obtain a consensus, aggregation of preferences) (e.g., [35], [36], [166]); (b) integration of organizational structures in organization science (e.g., [10], [38], [39], [41], [58]); and (c) integration of information (database schema integration, integration of knowledge base structures, integration of catalogs, merging and integration of ontologies) (e.g., [1], [14], [32], [123], [131], [134], [159]).

In the article, many illustrative applied examples are presented. It is necessary to point out fundamentals of the described approaches correspond to practice (e.g., engineering, management). Thus, the suggested composite solving schemes and their local parts have to be based on a combination of mathematical combinatorial models and expert judgment of domain experts. Our approach for modeling the complex modular solutions/systems is based on the following four layers: (i) system hierarchy as tree-like structure, (ii) system components (leaf nodes of the tree-like mode above), (iii) sets of design alternatives for each system components, (iv) compatibility between design alternatives of different system components. Thus, models, problems, and algorithmic schemes are examined for the above-mentioned structures: proximities/metrics, substructures (including median/consensus, etc.), aggregation strategies/frameworks. The considered solving strategies are based on combinatorial problems (multicriteria ranking/selection, knapsack problem, multiple choice problem, morphological combinatorial synthesis, building median/consensus for structures).

The suggested aggregation problems may be useful in the following situations: (a) design processes based on uncertainty (e.g., fuzzy sets, stochastic models) can lead to generating a set (as a grid) of design solutions (here the problem under uncertainty can be approximated by a set of deterministic problems and, further, their solutions can be aggregated); (b) scenario-based methods can lead to a set of design solutions which can be aggregated. Note, complicated methods and models are required for dynamical modeling of complex systems, for example: (a) various kinds of Petri nets, (b) dynamical graphs. Our material does not involve this type of studies.

In the future, the following research directions can be considered:

1. usage of the suggested aggregation approaches for various kinds of system configuration solutions (e.g., set of selected elements, assignment/allocation solutions, network-like solutions [110]);
2. usage of other types of metrics/proximities for structures;
3. additional theoretical and applied studies of formal approaches to aggregation problems based on aggregation of system tree-like models and/or general system structures (i.e., multicriteria searching for median-like tree(s) and/or median-like structure(s) as Pareto-efficient structured solution(s));
4. examination of more complicated design problems for several resultant aggregated solutions (e.g., as “product line”);
5. examination of various models (for example, building of median/consensus), including multicriteria problem statements and usage of special quality domains/spaces, e.g., lattice-like quality domain/space ([101], [103], [106]);

6. examination and usage of other structures for system modeling, e.g., pyramids ([24], [70]);
7. taking into account uncertainty;
8. usage of artificial intelligence methods in problem solving processes;
9. investigation of new applications;
10. usage of the suggested aggregation problems as auxiliary underlying sub-problems in information integration/fusion (for example, for approximation of alignment-like problems in bioinformatics, image processing; multi-source fusion of structured information);
11. special examination of aggregation problems for aggregation of solutions in combinatorial optimization problems (e.g., routing, scheduling, traveling salesman problem, assignment/allocation, graph coloring, covering);
12. usage of the suggested aggregation approaches in electronic shopping (and recommender systems) as the following two-stage framework: (i) an user is selecting a preliminary set of modular products (by his/her choice) from product catalogs, (ii) a computer system (i.e., special design support service) is constructing an aggregated product (selection of the best product from the preliminary product set is a simplified case);
13. it may be very interesting to apply the suggested aggregation approaches to drug design (generally, to combinatorial chemistry); and
14. usage of the suggested aggregation approaches in education (engineering, management, computer science and information technology).

REFERENCES

- [1] R. Agarwal, R. Srikant, On integrating catalogs. In: *Proc. 10th Int. World Wide Web Conf. WWW 2001*, Hong Kong, 603-612, May 2001.
- [2] T. Akatsu, M.M. Halldorsson, On the approximation of largest common subtrees and largest common point sets. *Theoretical Computer Science*, 233(1-2), 33-50, 2000.
- [3] A. Amir, D. Keselman, Maximum agreement subtree in a set of evolutionary trees: metrics and efficient algorithms. *SIAM J. Comput.*, 26(6), 1656-1669, 1997.
- [4] A. Amir, G.M. Landau, J.C. Na, H. Park, K. Park, J.S. Sim, Consensus optimizing both distance sum and radius. In: J. Karlgren, J. Tarhio, H. Hyyro (Eds.), *Int. Conf. on String Processing and Information Retrieval SPIRE 2009*, LNCS 5721, Springer, pp. 234-242, 2009.
- [5] A. Amir, G.M. Landau, J.C. Na, H. Park, K. Park, J.S. Sim, Efficient algorithms for consensus string problems minimizing both distance sum and radius. *Theoretical Computer Science*, 412(39), 5239-5246, 2011.
- [6] A. Apostolico, String editing and longest common subsequences. In: G. Rozenberg, A. Salomaa (Eds.) *Handbook of Formal Languages*, vol. 2, Springer, 361-398, 1997.
- [7] A. Apostolico, C. Guerra, The longest common subsequence problem revised. *Algorithmica*, 2(1-4), 315-336, 1987.
- [8] M. Arnold, E. Ohlebusch, Linear time algorithms for generalizations of the longest common substring problem. *Algorithmica*, 60(4), 806-818, 2011.
- [9] R.U. Ayres, *Technological Forecasting and Long-Time Planning*, New York: McGraw-Hill, 1969.
- [10] H.H. Baligh, *Organization Structures: Theory and Design, Analysis and Prescription*. Springer, 2006.
- [11] M.S. Bansal, D. Fernandez-Baca, Computing distances between partial rankings. *Information Processing Letters*, 109(4), 238-241, 2009.
- [12] J.-P. Barthelemy, A. Guenoche, O. Hudey, Median linear orders: Heuristics and a branch and bound algorithm. *EJOR*, 42(3), 313-325, 1989.
- [13] B.A. Barton, Searching a bitstream in linear time for the longest substring of any given density. *Algorithmica*, 61(3), 555-579, 2011.

- [14] C. Batini, M. Lenzerini, S.B. Navathe, A comparative study of methodologies for data base schema integration. *ACM Computing Survey*, 18(4), 323-364, 1986.
- [15] C. Bazgan, H. Hugot, Solving efficiently the 0-1 multiobjective knapsack problem. *Computers and Operations Research*, 36(1), 260-279, 2009.
- [16] M.P. Beck, B.W. Lin, Some heuristics for the consensus ranking problem. *Computers and Operations Research*, 10(1), 183, 1-7, 1983.
- [17] A.R. Belkin, M.Sh. Levin, *Decision Making: Combinatorial Models of Information Approximation*. Nauka Publ. House, Moscow, 1990 (in Russian).
- [18] L. Bergroth, H. Hakonen, T. Raita, A survey of longest common subsequence algorithms. In: *Proc. of the Seventh Int. Symp. on String Processing and Information Retrieval SPIRE'00*, 39-48, 2000.
- [19] V. Berry, F. Nicolas, Maximum agreement and compatible supertrees. In: *Proc. of the 15th Annual Symp. on Combinatorial Pattern Matching CPM-2004*, LNCS 3109, Springer, Berlin, pp. 205-219, 2004.
- [20] P. Bille, A survey on edit distance and related problems. *Theoretical Computer Science*, 337(1-3), 217-239, 2005.
- [21] C. Blum, M.J. Blesa, M.L. Ibanez, Beam search for the longest common subsequence problem. *Comp. and Oper. Res.*, 36(12), 3178-3186, 2009.
- [22] K.P. Bogart, Preference structures I: distance between transitive preference relations. *J. of Math. Soc.*, 3, 49-67, 1973.
- [23] S. Brin, L. Page, R. Motwani, T. Winograd, *The PageRank Citation Ranking: Bringing Order to the Web*. Technical report 1999-0120, Computer Science Dept., Stanford Univ., Stanford, CA, 1999.
- [24] L. Brun, W.G. Kropatsch, Construction of combinatorial pyramids. In: W. Hancock, M. Vento (Eds.), *Proc. IAPR Workshop GbPRP 2003*, LNCS 2726, Springer, 1-12, 2003.
- [25] H. Bunke, On a relation between graph edit distance and maximum common subgraph. *Pattern Recognition Letters*, 18(8), 689-694, 1997.
- [26] H. Bunke, K. Shearer, A graph distance metric based on the maximal common subgraph. *Pattern Recognition Letters*, 19(3-4), 255-259, 1998.
- [27] R. Burkard, M. Dell'Amico, S. Martello, *Assignment Problems*. SIAM, Providence, 2009.
- [28] E. Cela, *The Quadratic Assignment Problem: Theory and Algorithms*. Kluwer Academic Publishers, Dordrecht, 1998.
- [29] T.P. Chartier, E. Krentzer, A.N. Langville, K.E. Pedings, Sensitivity and stability of ranking vectors. *SIAM J. on Scientific Computing*, 33(3), 1077-1102, 2011.
- [30] F. Chataigner, Approximating the maximum agreement forest on k trees. *Information Processing Letters*, 93(5), 239-244, 2005.
- [31] W. Chen, New algorithm for ordered tree-to-tree correction problem. *J. of Algorithms*, 40(2), 135-158, 2001.
- [32] N. Choi, I.-Y. Song, H. Han, A survey on ontology mapping. *SIGMOD Record*, 35(3), 34-41, 2006.
- [33] R. Connor, F. Simeoni, M. Iakovos, R. Moss, A bounded distance metric for comparing tree structure. *Information Systems*, 36(4), 748-764, 2011.
- [34] W.D. Cook, L.M. Seiford, Priority ranking and consensus formation. *Management Science*, 24(16) 1721-1732, 1978.
- [35] W.P. Cook, M. Kress, *Ordinal Information and Preference Structures: Decision Models and Applications*. Prentice-Hall, Englewood Cliffs, 1992.
- [36] W.D. Cook, L.M. Seiford, M.Kress, A General Framework for Distance-Based Consensus in Ordinal Ranking Models. *European Journal of Operational Research*, 96(2) 392-397, 1996.
- [37] N. Cross, *Engineering Design Methods*. 3rd ed., Wiley, 2000.
- [38] K. Crowston, *A Taxonomy of Organizational Dependencies and Coordination Mechanisms*. Working Paper, No. 174, Center of Coordination Science, MIT, Cambridge, Aug. 1994.
- [39] A. Dan, D.M. Dias, R. Kearney, T.C. Lau, T.N. Nguyen, F.N. Parr, M.W. Sachs, H.H. Shaikh, Business-to-business integration with tpaML and a business-to-business protocol framework. *IBM Systems Journal*, 40(1), 68-90, 2001.
- [40] C. de la Higuera, F. Casacuberta, Topology of strings: Median string is NP-complete. *Theoretical Computer Science*, 230(1-2), 39-48, 2000.
- [41] G. Dessler, *Organizational Theory. Integrating Structure and Behaviour*. NJ.: Prentice Hall, 1980.

- [42] L.P. Dinu, F. Manea, An efficient approach for the rank aggregation problem. *Theoretical Computer Science*, 359(1-3), 455-461, 2006.
- [43] A. Dovier, E.G. Policriti, G. Rossi, A uniform axiomatic view of lists, multisets, and sets, and the relevant unification algorithms. *Fundamenta Informaticae*, 36(2/3), 201-234, 1998.
- [44] S. Dulucq, H. Touzet, Analysis of tree edit distance algorithms. In: R. Baeza-Yates, E. Chavez, M. Crochemore (Eds.), *Proc. 14th Annual Symp. on Combinatorial Pattern Matching CPM 2003*, LNCS 2676, Springer, 83-95, 2003.
- [45] T.H. Duong, N.T. Nguyen, G.S. Jo, A hybrid method for integrating multiple ontologies. *Cybernetics and Systems*, 40(2), 123-145, 2009.
- [46] T. Easton, A. Singireddy, A large neighborhood search heuristic for the longest common subsequence problem. *J. of Heuristics*, 14(3), 271-283, 2008.
- [47] L. Eghe, C. Michel, String similarity measures for ordered sets of documents in information retrieval. *Information Processing and Management*, 38(6), 823-848, 2003.
- [48] M. Ehrgott, *Multicriteria optimization*. Springer, Berlin, 2005.
- [49] O. Elemento, O. Gascuet, An exact and polynomial distance-based algorithm to reconstruct single copy tandem duplication trees. In: R. Baeza-Yates, E. Chavez, M. Crochemore (Eds.), *Proc. 14th Annual Symp. on Combinatorial Pattern Matching CPM 2003*, LNCS 2676, Springer, 96-108, 2003.
- [50] C. Elzinga, H. Wang, Z. Lin, Y. Kumar, Concordance and consensus. *Information Sciences*, 181(12), 2529-2549, 2011.
- [51] R. Fagin, R. Kumar, M. Mahdian, D. Sivakumar, E. Vee, Comparing partial rankings. *SIAM J. Discrete Math.*, 20(3), 628-648, 2006.
- [52] M. Farach, T. Przytycka, M. Thorup, On the agreement of many trees. *Inf. Process. Lett.*, 55(6), 297-301, 1995.
- [53] M. Ferrer, E. Valveny, F. Serratos, K. Riesen, H. Bunke, Generalized median graph computation for means of graph embedding in vector space. *Pattern Recognition*, 43(4), 1642-1655, 2010.
- [54] C.R. Finden, A.D. Gordon, Obtaining common pruned trees. *J. Classif.*, 2(1) 255-276, 1985.
- [55] J. Gallant, D. Maier, J.A. Storer, On finding minimal length superstrings. *J. Comput. Syst. Sci.*, 20(1), 50-58, 1980.
- [56] X. Gandibleux, A. Freville, Tabu search based procedure for solving the 0-1 multiobjective knapsack problem: the two case. *J. of Heuristics*, 6(3), 361-383, 2000.
- [57] M.R. Garey, D.S. Johnson, *Computers and Intractability. The Guide to the Theory of NP-Completeness*, San Francisco: W.H. Freeman and Company, 1979.
- [58] S. Ghoshal, L. Gratton, Integrating the enterprise. *MIT Sloan Management Review*, 44(1), 31-38, 2002.
- [59] F.C. Gomes, C.N. de Mendes, P.M. Pardalos, C.V.R. Viana, A parallel multistart algorithm for the closest string problem. *Comp. and Oper. Res.*, 35(11), 3636-3643, 2008.
- [60] A.D. Gordon, Constructing dissimilarity measures. *J. Classif.*, 7(2), 257-269, 1990.
- [61] J.C. Gower, Measures of similarity, dissimilarity, and distance. In: S. Kotz, N.L. Johnson (Eds.), *Encyclopedia of Statistical Science*, vol. 5, Wiley, New York, 397-405, 1985.
- [62] J. Gramm, Closest string problem. In: M.-Y. Kao, (Ed.), *Encyclopedia of Algorithms*, Springer, pp. 156-158, 2008.
- [63] J. Gramm, R. Niedermaier, P. Rossmanith, Fixed-parameter algorithms for closest string and related problems. *Algorithmica*, 37(1), 25-42, 2003.
- [64] S. Guillernot, F. Nocolas, Solving the maximum agreement subtree and the maximum compatible tree problems on many bounded degree trees. In: M. Lewenstein, G. Valiente (Eds.), *Proc. of the Int. Conf. on Combinatorial Pattern Matching CPM 2006*, LNCS 4009, Springer, 165-176, 2006.
- [65] D. Gusfield, *Algorithms on Strings, Trees and Sequences: Computer Science and Computational Biology*. Cambridge University Press, Cambridge, 1999.
- [66] M.T. Hallett, C. McCartin, A faster FPT algorithm for the maximum agreement forest problem. *Theory of Computing Systems*, 41(3), 539-550, 2007.
- [67] A.M. Hamel, M.A. Steel, Finding a maximum compatible tree is NP-hard for sequences and trees. *Applied Mathematical Letters*, 9(2), 55-59, 1996.
- [68] S. Hannenhalli, P. Pevzner, Transforming men into mice (polynomial algorithm for genomic distance problem). *36th Ann. Symp. on Foundations of Computer Science FOCS 1995*, Milwaukee, Wisconsin, IEEE Computer Society, 581-592, 1995.

- [69] D. Harel, STATECHARTS: A visual formalism for complex systems, *Science of Computer Programming*, 8(3), 231-274, 1987.
- [70] Y. Haxhimusa, R. Gland, W.G. Kropatsch, Constructing stochastic pyramids by MIDES - maximal independent directed edge set. In: W. Hancock, M. Vento (Eds.), *Proc. IAPR Workshop GbPRP 2003*, LNCS 2726, Springer, 24-34, 2003.
- [71] F. Herrera, E. Herrera-Viedma, J.L. Verdegay, A rational consensus model in group decision making using linguistic assessments. *Fuzzy Sets and Systems*, 88(1), 31-49, 1997.
- [72] E. Herrera-Viedma, F. Herrera, F. Chiclana, A consensus model for multiperson decision making with different preference structures. *IEEE Trans. SMC, Part A*, 32(3), 394-402, 2002.
- [73] C. Hiremath, R.R. Hill, New greedy heuristics for the multiple-choice multidimensional knapsack problem. *Int. J. of Operational Research*, 2(4), 495-512, 2007.
- [74] D.S. Hirschberg, Algorithms for the longest common subsequence problem. *J. of the ACM*, 24(4), 664-675, 1977.
- [75] V.T. Hoang, W.-K. Sung, Improved algorithms for maximum agreement and compatible supertrees. *Algorithmica* 59(2), 195-214, 2011.
- [76] J. Jansson, J.H.-K. Ng, K. Sadakane, W.-K. Sung, Rooted maximum agreement supertrees. *Algorithmica*, 43(4), 293-307, 2005.
- [77] T. Jech, *Set Theory*, Springer, Berlin, 2002.
- [78] T. Jiang, M. Li, On the approximation of shortest common supersequences and longest common subsequences. *SIAM J. on Computing*, 24(5), 1122-1139, 1995.
- [79] T. Jiang, V.G. Timkovsky, Shortest consistent superstring computable in polynomial time. *Theor. Comput. Sci.*, 143(1), 113-122, 1995.
- [80] T. Jiang, L. Wang, K. Zhang, Alignment of trees - an alternative to tree edit. *Theoretical Computer Science*, 143(1), 137-148, 1995.
- [81] X. Jiang, A. Munger, H. Bunke, On median graphs: properties, algorithms, and applications. *IEEE Trans. PAMI*, 23(10), 1144-1151, 2001.
- [82] X. Jiang, H. Bunke, J. Csirik, Median strings: A review. In: M. Last, A.A. Kandel, H. Bunke, (Eds.), *Data Mining in Time Series Databases*. World Scientific, 173-192, 2004.
- [83] D.S. Johnson, K.A. Niemi, On knapsack, partitions, and a new dynamic programming techniques for trees. *Mathematics of Operations Research*, 8(1), 1-14, 1983.
- [84] J.C. Jones, *Design Methods*, J. Wiley & Sons, New York, 1981.
- [85] H. Kaplan, N. Sharir, The greedy algorithm for shortest superstrings. *Inf. Process. Lett.*, 93(1), 13-17, 2005.
- [86] H. Kellerer, U. Pferschy, D. Pisinger, *Knapsack Problems*. Berlin, Springer, 2004.
- [87] T. Kelsey, L. Kotthoff, The exact closest string problem as a constraint satisfaction problem. Electronic preprint, CoRR, abs./1005.0089, 2010.
- [88] J. Kemeny, Mathematics without Numbers. *Daedalus*, vol. 88, 577-591, 1959.
- [89] J.G. Kemeny, and J.L. Snell, *Mathematical Models in the Social Sciences*, Reprint, Cambridge, Mass., The MIT Press, 1972.
- [90] M. Kendall, *Rank Correlation Methods*, 3rd ed., Hafner, New York, 1962.
- [91] W.J.M. Kickert, *Fuzzy Theories on Decision Making*. Nijhoff, London, 1978.
- [92] Klamroth, M. Wiecek, Dynamic programming approaches to the multiple criteria knapsack problem. *Naval Research Logistics*, 47(1), 57-76, 2000.
- [93] D.E. Knuth, *The Art of Computer Programming*, Vol. 2: Seminumerical Algorithms. (3rd ed.). Addison Wesley, 1998.
- [94] T. Kohonen, Median strings. *Pattern Recognition Letters*, 3(5), 309-313, 1985.
- [95] H.A. Kruger, W.D. Kearney, Consensus ranking - An ICT security awareness case study. *Computers & Security*, 27(7-8), 254-259, 2008.
- [96] H.W. Kuhn, The Hungarian method for the assignment problems. *Naval Res. Log.*, 2(1-2), 83-97, 1955 (reprinted in *Naval Res. Log.*, 52(1), 7-21, 2005).
- [97] V.I. Levenshtein, Binary codes capable of correcting deletions, insertions and reversals. *Cybernetics and Control Theory*, 10(8), 707-710, 1966.
- [98] M.Sh. Levin, Vector-like proximity estimates for structures. In: *All-Russian Conf. "Problems and Methods of Decision Making in Organizational Management Systems"*, Moscow, Inst. for System Analysis, 116-117, 1988 (in Russian).
- [99] M.Sh. Levin, Hierarchical decision making for education in information engineering. In: *Proc. of 7th Ann. Eur. Conf. of EAEEIE*, Oulu, pp. 301-307, 1996.

- [100] M.Sh. Levin, Towards comparison of decomposable systems. In: *Data Science, Classification, and Related Methods*, Springer, Tokyo, pp. 154-161, 1998.
- [101] M.Sh. Levin, *Combinatorial Engineering of Decomposable Systems*. Kluwer, 1998.
- [102] M.Sh. Levin, Towards systems engineering education. In: *Proc. of 15th Eur. Meeting on cybern.. and Syst. Res. EMCSR'2011*, vol. 1, Vienna, pp. 257-262, 2000.
- [103] M.Sh. Levin, System synthesis with morphological clique problem: fusion of subsystem evaluation decisions, *Inform. Fusion*, 2(3), 225-237, 2001.
- [104] M.Sh. Levin, Common part of preference relations. *Foundations of Computing & Dec. Sciences*, 28(4), 223-246, 2003.
- [105] M.Sh. Levin, Modular system synthesis: example for composite packaged software, *IEEE Trans. on SMC - Part C*, 35(4), 544-553, 2005.
- [106] M.Sh. Levin, *Composite Systems Decisions*, New York, Springer, 2006.
- [107] M.Sh. Levin, Towards hierarchical clustering, In: V. Diekert, M. Volkov, A. Voronkov, (Eds.), *CSR 2007*, LNCS 4649, Springer, 205-215, 2007.
- [108] M.Sh. Levin, Combinatorial technological systems problems (examples for communication system), *Proc. of Int. Conf. on Systems Engineering and Modeling ICSEM-2007*, Israel, pp. 24-32, 2007.
- [109] M.Sh. Levin, Morphological approach to electronic shopping, *2008 IEEE Region 8 Int. Conf. "SIBIRCON-2008"*, Novosibirsk, pp. 280-285, 2008.
- [110] M.Sh. Levin, Combinatorial optimization in system configuration design, *Automation and Remote Control*, 70(3), 519-561, 2009.
- [111] M.Sh. Levin, Towards communication network development (structural systems issues, combinatorial models), *Proc. of IEEE Region 8 Int. Conf. Sibircon 2010*, vol. 1, pp. 204-208, 2010.
- [112] M.Sh. Levin, Restructuring in combinatorial optimization. Electronic preprint. 11 pp., Febr. 8, 2011. <http://arxiv.org/abs/1102.1745> [cs.DS]
- [113] M.Sh. Levin, Course on system design (structural approach). Electronic preprint, 22 pp., Febr. 19, 2011. <http://arxiv.org/abs/1103.3845> [cs.DS]
- [114] M.Sh. Levin, Towards configuration of applied Web-based information system. Electronic preprint, 13 pp., Aug. 31, 2011. <http://arxiv.org/abs/3108.3865> [cs.SE]
- [115] M.Sh. Levin, A.A. Mikhailov, *Fragments of Objects Set Stratification Technology*, Preprint, Moscow, Inst. for Systems Studies (RAS), 60 p., 1988 (in Russian)
- [116] M.Sh. Levin, I.A. Khodakovskii, Structural composition of the telemetry system. *Automation and Remote Control*, 68(9), 1654-1661, 2007.
- [117] M.Sh. Levin, A.V. Leus, Configuration of integrated security system. *7th IEEE Int. Conf. on Industrial Informatics INDIN 2009*, Cardiff, UK, pp. 101-105, 2009.
- [118] M.Sh. Levin, A.V. Safonov, Towards modular redesign of networked system, *Proc. of Int. Conf. on Ultra Modern Telecommunication 'ICUMT 2010'*, Moscow, pp. 109-114, 2010.
- [119] M.Sh. Levin, A. Andrushevich, R. Kistler, A. Klapproth, Combinatorial evolution of ZigBee protocol. *IEEE Region 8 Int. Conf. Sibircon 2010*, vol. 1, 314-319, 2010.
- [120] M.Sh. Levin, A.V. Safonov, Improvement of regional telecommunications networks. *J. of Communications Technology and Electronics*, 56(6), 770-778, 2011.
- [121] M.Sh. Levin, A. Andrushevich, A. Klapproth, Improvement of building automation system. K.G. Mehrotra et al. (Eds.), *Proc. of 24th Int. Conf. IEA/AIE 2011*, LNCS 6704, Part II, Springer, 459-468, 2011.
- [122] M. Li, B. Ma, L. Wang, On the closest string and substrings problem. *J. of the ACM*, 49(2), 157-171, 2002.
- [123] J. Lin, Integration of weighted knowledge bases. *Artificial Intelligence*, 83(2), 363-378, 1996.
- [124] T. Lust, J. Teghem, The multiobjective multidimensional knapsack problem: a survey and a new approach. Techn. Rep., arXiv: 1007.4063v1, 2010. <http://arxiv.org/abs/1007.4063.v1>
- [125] B. Ma, X. Sun, More efficient algorithms for closest string and substrings problems. In: M. Vingron, L. Wong (Eds.), *Int. Conf. on Research in Computational Molecular Biology RECOMB 2008*, LNCS 4955, Springer, pp. 396-409, 2008.
- [126] D. Maier, The complexity of some problems on subsequences and supersequences. *J. of the ACM*, 25(2), 322-336, 1978.
- [127] A. Marzal, E. Vidal, Computation of normalized edit distance and applications. *IEEE Trans. PAMI*, 15(9), 926-932, 1993.

- [128] B.G. Mirkin, L.B. Chernyi, On measurement of distance between partition of a finite set of units. *Automation and Remote Control*, 31, 786-792, 1970.
- [129] S.R. Mousavi, F. Tabataba, An improved algorithm for the longest common subsequence problem. *Comp. and Oper. Res.*, 39(3), 512-520, 2012.
- [130] F. Nicolas, E. Rivals, Complexities of centre and median string problems. In: R. Baeza-Yates, E. Chavez, M. Crochemore (Eds.), *Proc. 14th Annual Symp. on Combinatorial Pattern Matching CPM 2003*, LNCS 2676, Springer, 315-327, 2003.
- [131] N. Noy, A.H. Doan, A.Y. Halevy, Semantic integration. *AI Magazine*, 26(1), 7-10, 2005.
- [132] R. Parra-Hernandez, N. Dimopoulos, A new heuristic for solving the multichoice multidimensional knapsack problem. *IEEE Trans. SMC - Part A*, 35(5), 708-717, 2002.
- [133] C. Phillips, T.J. Warnow, The asymmetric tree - A new model for building consensus tree. *Discrete Applied Mathematics*, 71(1-3), 311-335, 1996.
- [134] H.S. Pinto, J.P. Martins, A methodology for ontology integration. In: *Proc. of 1st Int. Conf. Knowledge Capture K-CAP'01*, Victoria, Canada, Sweden, 113-138, 2001.
- [135] S. Rasoul Mousavi, F. Tabataba, An improved algorithm for the longest common subsequence problem. *EJOR*, 39(3), 512-520.
- [136] J.W. Raymond, E.J. Gardiner, P. Willett, RASCAL: calculation of graph similarity using maximal common edge subgraph. *The Computer J.*, 45(6), 631-644, 2002.
- [137] A. Robles-Kelly, E.R. Hancock, string edit distance, random walks and graph matching. *Int. J. of Pattern Recognition and Artificial Intelligence*, 18(3), 315-327, 2004.
- [138] E.M. Rodrigues, M.F. Sagot, Y. Wakabayashi, The maximum agreement forest problem: Approximation algorithms and computational experiments. *Theoretical Computer Science*, 374(1-3), 91-110, 2007.
- [139] B. Roy, *Multicriteria Methodology for Decision Aiding*. Kluwer Academic Publishers, Dordrecht, 1996.
- [140] D. Sasha, K. Zhang, Simple fast algorithms for the editing distance between trees and related problems. *SIAM J. on Computing*, 18(6), 1245-1262, 1989.
- [141] S.M. Selkow, The tree-to-tree editing problem. *Information Processing Letters*, 6(6), 184-186, 1977.
- [142] C. Semple, M. Steel, A supertree method for rooted trees. *Discrete Appl. Math.*, 105(1-3), 147-158, 2000.
- [143] J.S. Sim, K. Park, The consensus string problem for a metric is NP-complete. In: R. Raman, J. Simpson (Eds.), *Proc. of the 10th Australian Workshop on Combinatorial Algorithms*, Perth, WA, Australia, pp. 107-113, 1999.
- [144] H.A. Simon, A. Newell, Heuristic problem solving: the next advance in operations research. *Operations Research*, 6(1), 1-10, 1958.
- [145] C. Solnon, J.-M. Jolion, Generalized vs set median string for histogram based distances: Algorithms and classification results in image domain. In: F. Escolano, M. Vento (Eds.), *Proc. of the 6th Workshop on Graph Based Representation in Pattern Recognition GbPrP 2007*, LNCS 4538, Springer, 404-414, 2007.
- [146] M. Steel, T. Warnow, Kaikoura tree theorems: Computing the maximum agreement subtree. *Inf. Process. Lett.*, 48(2), 77-82, 1993.
- [147] A. Syropoulos, Mathematics of Multisets, in C. S. Calude et al. (eds.), *Multiset Processing: Mathematical, Computer Science, and Molecular Computing Points of View*, LNCS 2235, Springer, pp.347-358, 2001.
- [148] K.-C. Tai, The tree-to-tree correction problem. *J. of the ACM*, 26(3), 422-433, 1979.
- [149] E. Tanaka, A metric between unrooted and unordered trees and its bottom-up computing method. *IEEE Trans. PAMI*, 16(12), 1233-1238, 1994.
- [150] E. Tanaka, K. Tanaka, The tree-to-tree editing problem. *Int. J. Pattern Recogn. and Art. Intell.*, 2(2), 221-240, 1988.
- [151] J. Tarhio, E. Ukkonen, A greedy approximation algorithm for constructing shortest common superstrings. *Theor. Comput. Sci.*, 57(1), 131-145, 1988.
- [152] M. Tavana, CROSS: a multicriteria group-decision-making model for evaluating and prioritizing advanced-technology projects at NASA. *Interfaces*, 33(3), 40-56, 2003.
- [153] V.G. Timkovsky, Complexity of common subsequence and supersequence problems. *Cybernetics and Systems Analysis*, 25(5), 565-580, 1989.

- [154] A. Torsello, E.R. Hancock, Efficiently computing weighted tree edit-distance using relaxation labeling. In: M. Figueiredo, J. Zerubia, A.K. Jain (Eds.), *Energy Minimization Methods in Computer Vision and Pattern Recognition*. LNCS 2134, Springer, 438-453, 2001.
- [155] A. Torsello, D. Hidovic, M. Pelillo, Polynomial-time metrics for attributed trees. *IEEE Trans. PAMI*, 27(7), 1087-1099, 2005.
- [156] G. Valiente, An efficient bottom-up distance between trees. *Proc. of the 8th Int. Symp. String Processing Information Retrieval SPIRE 2001*, IEEE Computer Science Press, Laguna de San Rafael, Chile 212-219, 2001.
- [157] G. Valiente, *Algorithms on Trees and Graphs*. Springer, Berlin, 2002.
- [158] E. Vidal, A. Marzal, P. Aibar, Fast computation of normalized edit distances. *IEEE Trans. PAMI*, 17(9), 899-902, 1995.
- [159] H. Wache, T. Vogege, U. Visser, H. Stickenschmidt, G. Schuster, H. Neumann, S. Hubner, Ontology-based integration of information - A survey of existing methods, In: *Proc. of Int. Workshop Ontologies and Information Sharing IJCAI-01*, Seattle, WA, 108-117, 2001.
- [160] R.A. Wagner, M.J. Fisher, The string-to-string correction problem. *J. of the ACM*, 21(1), 168-173, 1974.
- [161] W.D. Wallis, P. Shoubridge, M. Kraetz, D. Ray, Graph distances using graph union. *Pattern Recognition Letters*, 22(6-7), 701-704, 2001.
- [162] J.T.-L. Wang, K. Zhang, Finding similar consensus between trees: An algorithm and distance hierarchy. *Pattern Recognition*, 34(1), 127-137, 2001.
- [163] J. Wang, J. Chen, J.M. Huang, An improved lower bound on approximation algorithms for the closest substring problem. *Information Processing Letters*, 107(1), 24-28, 2008.
- [164] C. Whidden, R.G. Beiko, N. Zeh, Fast FPT algorithms for computing rooted agreement forest: Theory and experiments. In: *Proc. of the 9th Int. Symp. on Experimental Algorithms SEA 2010*, LNCS 6049, Springer, 141-153, 2010.
- [165] C. Whidden, R.G. Beiko, N. Zeh, Fixed parameter and approximation algorithms for maximum agreement forests. Electronic preprint, 12 Aug. 2011, arXiv: 1108.2664v1 [q-bio.PE]
- [166] R.R. Yager, On ordered weighted averaging aggregation operators in multicriteria decision making. *IEEE Trans. SMC*, 18(1), 183-190, 1988.
- [167] W. Yang, Identifying syntactic differences between two programs. *Software - Practice and Experience*, 21(7), 739-755, 1991.
- [168] K. Zhang, A constrained edit-distance between unordered labeled trees. *Algorithmica*, 15(3), 205-222, 1996.
- [169] K. Zhang, D. Sasha, Simple fast algorithms for the editing distance between trees and related problems. *SIAM J. Comput.*, 18(6), 1245-1262, 1989.
- [170] K. Zhang, R. Statman, D. Sasha, On the editing distance between unordered labeled trees. *Inform. Process. Letters*, 42(3), 133-139, 1992.
- [171] K. Zhang, J.T.L. Wang, D. Shasha, On the editing distance between undirected acyclic graphs. *Int. J. Foundations of Computer Science*, 7(1), 43-57, 1996.
- [172] E. Zitzler, L. Thiele, Multiobjective evolutionary algorithms: a comparative case study and the strength Pareto approach. *IEEE Trans. on Evolutionary Computation*, 3(4), 257-271, 1999.
- [173] C. Zopounidis, M. Doumpos, Multicriteria classification and sorting methods: a literature review, *EJOR*, 138(2), 229-246, 2002.
- [174] C. Zopounidis, M. Doumpos, Multicriteria sorting methods. In: C.A. Floudas, P.M. Pardalos (Eds.), *Encyclopedia of Optimization*. 2nd ed., Springer, pp. 2379-2396, 2009.
- [175] F. Zwicky, *Discovery Invention, Research Through the Morphological Approach*. New York: McMillan, 1969.

HOME ADDRESS: MARK SH. LEVIN, SUMSKOY PROEzd 5-1-103, MOSCOW 117208, RUSSIA;
 MAIL ADDRESS: POB 102, MOSCOW 117208, RUSSIA; HTTP: //WWW.MSLEVIN.ITP.RU/
 E-mail address: mslevin@acm.org