

ON THE SPECTRUM OF 1D QUANTUM ISING QUASICRYSTAL

WILLIAM N. YESSEN

ABSTRACT. We consider one dimensional quantum Ising spin-1/2 chains with two-valued nearest neighbor couplings arranged in a quasi-periodic sequence, with uniform, transverse magnetic field. By employing the Jordan-Wigner transformation of the spin operators to spinless fermions, the energy spectrum can be computed exactly on a finite lattice. By employing the transfer matrix technique and investigating the dynamics of the corresponding trace map, we show that in the thermodynamic limit the energy spectrum is a Cantor set of zero Lebesgue measure. Moreover, we show that local Hausdorff dimension is continuous and non-constant over the spectrum. This forms a rigorous counterpart of numerous numerical studies.

1. INTRODUCTION

Since the discovery of quasicrystals [49, 50, 64, 69], quasi-periodic models in mathematical physics have formed an active area of research. In all of these models, quasi-periodicity is introduced via so-called quasi-periodic sequences, which, roughly speaking, are somewhat intermediate between periodic and random (for a textbook exposition, see [25, 59]), and are meant to model microscopic quasi-periodic structure of quasicrystals (not all such sequences necessarily correspond to a microscopic organization of an actual physical material, but the Fibonacci substitution sequence, which we consider here, does correspond to an actual quasicrystal made up of two microscopic constituents whose arrangement resembles the Fibonacci substitution sequence). One of the main tools in the investigation of such models has been renormalization analysis, leading to renormalization maps whose properties (or, better to say, their action on appropriate spaces, typically \mathbb{R}^n) yield strong implications for the underlying models, which are usually very difficult or impossible to obtain by other means. These renormalization maps have been called *trace maps* (roughly) since they were originally introduced in [45, 48, 55] (see also [3, 37, 44, 47, 62, 63, 70, 75] and references therein). The terminology is meant to emphasize their intimate connection to the transfer matrix formalism, perhaps better known to statistical physicists, which is a renormalization procedure that allows one to study some relevant properties of statistical-mechanical models via traces of appropriate *transfer operators*. (One has to note, however, that in the past few decades these techniques have been greatly generalized by

Date: February 18, 2022.

2010 Mathematics Subject Classification. Primary: 82B20, 82B44, 82D30. Secondary: 82D40, 82B10, 82B26, 82B27.

Key words and phrases. lattice systems, disordered systems, quasi-periodicity, quasicrystals, disordered materials, quantum Ising model, Fibonacci Hamiltonian, trace map.

The author was supported by the NSF grants DMS-0901627, PI: A. Gorodetski and IIS-1018433, PI: M. Welling and Co-PI: A. Gorodetski.

mathematicians, leading to exciting results in a few fields; among the wider known ones would be spectral theory [in particular of ergodic Schrödinger operators] and dynamical systems [in the spirit of works by R. Bowen, D. Ruelle and Ya. Sinai on thermodynamic formalism]). The method of trace maps has led, for example, to fundamental results in spectral theory of discrete Schrödinger operators and Ising models on one-dimensional quasi-periodic lattices (for Schrödinger operators: [5, 12, 14, 15, 17, 18, 20, 23, 48, 60, 71], for Ising models: [6, 7, 13, 24, 33, 74, 76, 84], and references therein).

Quasi-periodicity and the associated trace map formalism is still an area of active investigation, mostly in connection with their applications in physics. In this paper we use these techniques to investigate the energy spectrum of one-dimensional quantum Ising spin chains with two-valued nearest neighbor couplings arranged in a quasi-periodic sequence, with uniform, transverse magnetic field. We shall concentrate on the quasi-periodic sequence generated by the Fibonacci substitution on two symbols, which (probably due to the original choice of models in early 1980's) is the most widely studied case (and a representative example of many observed phenomena exhibited by quasi-periodic models in general).

One-dimensional quasi-periodic quantum Ising spin chains have been investigated (analytically and numerically) over the past two decades [3, 6, 7, 13, 24, 33, 39–42, 77, 84]. Numerical and some analytic results suggest Cantor structure of the energy spectrum, with nonuniform local scaling (i.e. a multifractal). The multifractal structure of the energy spectrum has not been shown rigorously.

Our aim here is to prove the multifractality of the energy spectrum and investigate its fractal dimensions. We achieve this by carrying out a renormalization procedure, using in a crucial way quasi-periodicity of (i.e. the repetitive, albeit not periodic, nature of) the sequence of interaction couplings (which are chosen according to the aforementioned Fibonacci substitution). The renormalization map turns out to be a second degree polynomial acting on \mathbb{R}^3 – the so-called *trace map*. We then investigate the discrete time dynamics of this polynomial map, relating the energy spectrum to invariant sets for the renormalization map. Techniques from hyperbolic and partially hyperbolic dynamics are then employed to investigate topological and fractal-dimensional properties of these invariant sets, concluding with our main result about the energy spectrum which, roughly speaking, states: *The spectrum is a zero measure Cantor set with non-constant local scaling (i.e. a multifractal); the spectrum and its fractal dimensions depend continuously on the parameters of the model.* We should note that these observations are not entirely in line with what has been observed in spectral analysis of quasi-periodic Schrödinger operators, since in the latter, the spectrum, while a Cantor set, is not a multifractal (i.e. local scaling is uniform throughout the spectrum). We comment on this in more detail in Section 5.1.

Certainly the technique described above is not new and has been employed numerous times (see the references above), most notably in the context of quasi-periodic Schrödinger operators in one dimension; however, to the best of the author's knowledge, this is the first rigorous treatment of quantum one-dimensional discrete quasi-periodic Ising models that provides rigorous results regarding the multifractal structure of the spectrum. Even though, as is mentioned later in the course of this paper, the Ising model that we are concerned with here can be mapped canonically to a Jacobi operator (which resembles in many ways the Schrödinger

operator), the method of trace maps, while still applicable, presents certain technical difficulties that are not present in the context of Schrödinger operators. We discuss in more detail these difficulties in Section 5.1; let us only mention here that the techniques that we developed in this paper seem to be applicable in a wide range of models, and can be substantially generalized and presented in a model-independent fashion. The present paper, however, is already rather involved and technical (which is to be expected, as one has to perform a number of transformations from the original spectral-theoretic problem to a problem of geometry and dynamical systems); for this reason it had been decided to postpone generalizations (at the time when this paper was written). First steps towards developing a general toolbox were later taken in [21, Section 2] jointly with D. Damanik and P. Munger. In that same paper, [21], we investigated spectral properties of a class of five-diagonal unitary operators, commonly called the *CMV matrices*, that play a central role in the theory of orthogonal polynomials on the unit circle (in fact, CMV matrices are to orthogonal polynomials on the unit circle as the tridiagonal Jacobi operators are to orthogonal polynomials on the real line [66, 67]). Not surprisingly, the techniques that we develop here (and generalize in [21]), among other techniques, were successfully applied to spectral theory of quasi-periodic CMV matrices in [21]. In the same fashion, these techniques have been successfully applied to quasi-periodic Jacobi matrices in [82]. Applications of our results from [21] will be appearing in our forthcoming paper [22]; among the applications are the quantum walks on one-dimensional lattices with quasi-periodic (Fibonacci in particular) coin flips, and a canonical transformation between classical one-dimensional Ising models with external magnetic field and CMV matrices.

Not to get sidetracked too far, let us conclude this introduction by noting that we study and apply the trace map as a *real analytic map*; study of the complexified version (though within a different context) was carried out by S. Cantat in [11]. We have applied the trace map as a *holomorphic map on \mathbb{C}^3* in [80] as a renormalization map for the classical one-dimensional Ising model with quasi-periodic nearest neighbor interaction and magnetic field, and were able to relate the analyticity of the free energy function to the analyticity of the escape rate of orbits under the action of the trace map, proving absence of phase transitions. Also in [80] we applied the techniques from the present paper to obtain precise description of the Lee-Yang zeros of the classical model in the thermodynamic limit. (The results in [80] were obtained some months after the present paper was written). At this point we would like to mention the work of P. Bleher et. al. [8–10] on Ising models on certain two-dimensional lattices (though not quasi-periodic and not involving trace maps), where the action of the renormalization map was treated as a holomorphic dynamical system.

Let us also briefly mention that, apart from their applications, trace maps present an interest to the dynamical systems community as a family of polynomial maps exhibiting quite rich dynamics ([11, 38, 61–63] and references therein, and our forthcoming work [28]). In addition to the references from above, for a broad overview of the recent developments and open problems, the interested reader may consult the surveys [16] (with emphasis on the Schrödinger operator) and the forthcoming [81] (with emphasis on the dynamics of trace maps and applications to a class of models, including quantum and classical Ising models).

2. THE 1D QUASI-PERIODIC QUANTUM ISING CHAIN

For a general overview of quasi-periodic (including Fibonacci) Ising models, see, for example, [29].

2.1. The model. Let $J_0, J_1 > 0$. Construct a $\{J_0, J_1\}$ -valued sequence $\{\tilde{J}_n\}_{n \in \mathbb{N}}$ by applying repeatedly the Fibonacci substitution rule on two letters:

$$(1) \quad J_0 \mapsto J_0 J_1 \quad \text{and} \quad J_1 \mapsto J_0,$$

starting with J_0 :

$$J_0 \mapsto J_0 J_1 \mapsto J_0 J_1 J_0 \mapsto J_0 J_1 J_0 J_0 J_1 \mapsto \cdots,$$

at each step substituting for J_0 and J_1 according to the substitution rule (1). By this procedure an infinite sequence is constructed, which we call $\{\tilde{J}_n\}_{n \in \mathbb{N}}$ (see [59] for more details on substitution sequences).

Let \hat{J}_k be the finite word after k applications of the substitution rule. It is easy to see that the following recurrence relation holds:

$$(2) \quad \hat{J}_{k+1} = \hat{J}_k \hat{J}_{k-1}.$$

The word \hat{J}_k has length F_k , where F_k is the k th Fibonacci number. The quasi-periodic (Fibonacci in our case) one-dimensional quantum Ising model on the finite one-dimensional lattice of N nodes with transversal external field is given by the *Ising Hamiltonian*

$$\mathcal{H} = - \sum_{n=1}^N \tilde{J}_n \sigma_n^{(x)} \sigma_{n+1}^{(x)} - h \sum_{n=1}^N \sigma_n^{(z)},$$

where $h > 0$ is the external magnetic field in the direction transversal to the lattice. The matrices $\sigma_j^{(x),(z)}$ are spin-1/2 operators in the x and z directions, respectively, given by

$$\sigma_n^{(x),(z)} = \underbrace{\mathbb{I} \oplus \cdots \oplus \mathbb{I}}_{n-1 \text{ times}} \oplus \sigma^{(x),(z)} \oplus \underbrace{\mathbb{I} \oplus \cdots \oplus \mathbb{I}}_{N-n+1 \text{ times}},$$

where \mathbb{I} is the 2×2 identity matrix. Here $\sigma^{(x),(z)}$ are the Pauli matrices given by

$$(3) \quad \sigma^{(x)} = \begin{pmatrix} 0 & 1 \\ 1 & 0 \end{pmatrix} \quad \text{and} \quad \sigma^{(z)} = \begin{pmatrix} 1 & 0 \\ 0 & -1 \end{pmatrix}.$$

The magnetic field h can be absorbed into interaction strength couplings J_0, J_1 , so \mathcal{H} can be rewritten as

$$(4) \quad \mathcal{H} = - \sum_{n=1}^N \left(\tilde{J}_n \sigma_n^{(x)} \sigma_{n+1}^{(x)} + \sigma_n^{(z)} \right).$$

The Hamiltonian \mathcal{H} in (4) acts on \mathbb{C}^{2N} , where we assume periodic boundary conditions: $\sigma_{N+1}^{(x),(z)} = \sigma_0^{(x),(z)}$. Here $\sigma_j^{(\alpha)}$, $\alpha \in \{x, z\}$, acts on the finite sequence $(c_1, \dots, c_N) \in \mathbb{C}^{2N}$ by acting by $\sigma^{(\alpha)}$ from (3) on the j -th entry, while leaving the other entries unchanged.

2.2. Fermionic representation. The spin model from the previous section can in fact be attacked as a so-called free-fermion model by performing the so-called Jordan-Wigner transformation, that transforms the Pauli operators $\sigma^{(x),(y)}$ into anti-commuting Fermi creation and annihilation operators. This technique dates at least as far back as the classical paper by P. Jordan and E. Wigner on second quantization [43]. The advantage in performing this transformation, is that the resulting Hamiltonian, in terms of the Fermi operators, can be diagonalized due to the anticommuting property of Fermi operators (commonly known in the physics community as the canonical commutation relations, or CCR for short). Furthermore, the Jordan-Wigner transformation is canonical (to conform to standard physics terminology) in the sense that it is invertible (in particular, no information is introduced and no information is lost by performing this transformation).

For convenience, let us denote by \mathcal{H}_k the Hamiltonian in (4) on a lattice of size F_k . We can then extend \mathcal{H}_k periodically to a Hamiltonian $\widehat{\mathcal{H}}_k$ over the periodic infinite lattice with the unit cell of length F_k . The operator \mathcal{H}_k , and hence also $\widehat{\mathcal{H}}_k$, can be cast into fermionic representation by means of the Jordan-Wigner transformation:

$$(5) \quad \mathcal{H}_k = \sum_{i,j} \left[c_i^\dagger A_{ij} c_j + \frac{1}{2} \left(c_i^\dagger B_{ij} c_j^\dagger + (c_i^\dagger B_{ij} c_j^\dagger)^\dagger \right) \right],$$

where c_i , $1 \leq i \leq F_k$, are anticommuting fermionic operators and a^\dagger denotes Hermitian conjugation of a . The terms A_{ij} and B_{ij} that appear in (5) are entries of the matrices A, B given by

$$\begin{aligned} A_{ii} &= -2, & A_{i,i+1} &= A_{i+1,i} = -\widetilde{J}_i, & A_{1,F_k} &= -\widetilde{J}_{F_k}; \\ B_{i,i+1} &= -\widetilde{J}_i, & B_{i+1,i} &= \widetilde{J}_i, & B_{1,F_k} &= \widetilde{J}_{F_k}; \end{aligned}$$

all other entries being zero. This method is due to E. Lieb et. al. [51], and its specialization to the Hamiltonian (4) is presented in some detail in [24]. We do not go into any further details here and invite the reader to consult the mentioned works.

Now, after we have performed the Jordan-Wigner transformation, the energy spectrum of the Hamiltonian in (5) can be computed by solving the so-called c -numeric equation for λ :

$$(6) \quad \begin{aligned} (A - B)\phi &= \lambda\psi, \\ (A + B)\psi &= \lambda\phi \end{aligned}$$

(see [51, Section B]). This equation can be written in the form [6, 13, 84]

$$\Phi_{i+1} = M_i(\lambda)\Phi_i,$$

where $\Phi_i = (\psi_i, \phi_i)^T$, and

$$M_i(\lambda) = \begin{pmatrix} -1/\widetilde{J}_i & \lambda/2\widetilde{J}_i \\ -\lambda/2\widetilde{J}_i & (\lambda^2 - 4\widetilde{J}_i^2)/4\widetilde{J}_i \end{pmatrix}.$$

Thus the wave function Φ at site N is given by

$$\Phi_{N+1} = M_N(\lambda) \times M_{N-1}(\lambda) \times \cdots \times M_0(\lambda)\Phi_0.$$

Letting $\widehat{M}_k(\lambda)$ denote the transfer matrix over F_k sites, using the recurrence relation in (2), we obtain

$$(7) \quad \widehat{M}_{k+1}(\lambda) = \widehat{M}_k(\lambda) \times \widehat{M}_{k-1}(\lambda),$$

for $k \geq 2$.

Returning to the Hamiltonian $\widehat{\mathcal{H}}_k$, we see that the wave function at site nF_k is given by

$$\Phi_{nF_k} = \widehat{M}_k(\lambda)^n \Phi_0.$$

The wave function over the infinite lattice should not diverge exponentially. Hence we allow only those values of λ for which the eigenvalues of $\widehat{M}_k(\lambda)$ lie in $[-1, 1]$. Since $\widehat{M}_k(\lambda)$ is unimodular, this is equivalent to the requirement

$$(8) \quad \frac{1}{2} \left| \text{Tr} \widehat{M}_k(\lambda) \right| \leq 1.$$

Let

$$x_k(\lambda) = \frac{1}{2} \text{Tr} \widehat{M}_k(\lambda).$$

Using the recursion relation (7), one may derive the recursion relation on the traces given by (see [45, 48, 55] and, for a more general discussion, [62])

$$x_{k+1} = 2x_k x_{k-1} - x_{k-2}.$$

Thus, in accordance with (8), we require that $|x_k| \leq 1$. Define the so-called *Fibonacci trace map* $f : \mathbb{R}^3 \rightarrow \mathbb{R}^3$ by

$$(9) \quad f(x, y, z) = (2xy - z, x, y).$$

Set

$$\begin{aligned} M_{-1}(\lambda) &= \begin{pmatrix} J_0/J_1 & \lambda(J_1^2 - J_0^2)/2J_0J_1 \\ 0 & J_1/J_0 \end{pmatrix}, \\ M_0(\lambda) &= \begin{pmatrix} -1/J_0 & \lambda/2J_0 \\ -\lambda/2J_0 & (\lambda^2 - 4J_0^2)/4J_0 \end{pmatrix}, \\ M_1(\lambda) &= \begin{pmatrix} -1/J_1 & \lambda/2J_1 \\ -\lambda/2J_1 & (\lambda^2 - 4J_1^2)/4J_1 \end{pmatrix} = M_0(\lambda) \times M_{-1}(\lambda). \end{aligned}$$

Then

$$x_{-1}(\lambda) = \left(\frac{J_0}{J_1} + \frac{J_1}{J_0} \right) / 2, \quad x_0(\lambda) = \frac{\lambda^2 - (4 + 4J_0^2)}{8J_0}, \quad x_1(\lambda) = \frac{\lambda^2 - (4 + 4J_1^2)}{8J_1}.$$

It is convenient to absorb the factor $1/4$ into λ^2 and rewrite

$$x_0(\lambda) = \frac{\lambda^2 - (1 + J_0^2)}{2J_0}, \quad x_1(\lambda) = \frac{\lambda^2 - (1 + J_1^2)}{2J_1}.$$

Define the line of initial conditions $\gamma_{(J_0, J_1)} : (-\infty, \infty) \rightarrow \mathbb{R}^3$ by

$$(10) \quad \gamma_{(J_0, J_1)}(\lambda) = \left(\frac{\lambda^2 - (1 + J_1^2)}{2J_1}, \frac{\lambda^2 - (1 + J_0^2)}{2J_0}, \left(\frac{J_0}{J_1} + \frac{J_1}{J_0} \right) / 2 \right).$$

Let π denote projection onto the third coordinate, and define

$$(11) \quad \sigma_k(J_0, J_1) = \{ \lambda : |\pi \circ f^k \circ \gamma_{(J_0, J_1)}(\lambda)| \leq 1 \},$$

where f^k denotes k -fold composition

$$f^k = \underbrace{f \circ f \circ \dots \circ f}_{k \text{ times}}, \quad k \geq 0.$$

For the sake of simplifying notation, we shall write simply σ_k , keeping in mind its implicit dependence on the choice of J_0 and J_1 . *With this setup, the set σ_k is the excitation spectrum of the periodic free-fermion model or, equivalently (via the inverse Jordan-Wigner transformation), the energy spectrum of the periodic spin model.* We are interested in understanding the spectrum in the thermodynamic limit, that is, $k \rightarrow \infty$.

2.3. The problem and main results. We wish to investigate the energy spectrum of $\widehat{\mathcal{H}}_k$ in the thermodynamic limit (that is, $k \rightarrow \infty$). Since $\pi \circ f^k \circ \gamma_{(J_0, J_1)}(\lambda)$ is a polynomial in λ , σ_k is a union of finitely many compact intervals (in general, see the exposition on Floquet theory applicable to periodic Hamiltonians, in, for example, [73, Chapter 4]). Supported by numerical evidence, it is believed that as $k \rightarrow \infty$, the sequence $\{\sigma_k\}_{k \in \mathbb{N}}$ shrinks to a Cantor set [7, 13, 24, 84] (i.e. a nonempty, compact, totally disconnected set with no isolated points). In Theorem 2.1 below we make precise the notion of the energy spectrum in the thermodynamic limit, and we rigorously examine its multifractal nature. Before we continue, however, we need to set up some notation.

We denote the Hausdorff metric on $\mathcal{P}(\mathbb{R})$ by \mathbf{dist}_H :

$$\mathbf{dist}_H(A, B) = \max \left\{ \sup_{a \in A} \inf_{b \in B} \{|a - b|\}, \sup_{b \in B} \inf_{a \in A} \{|a - b|\} \right\}.$$

We denote the Hausdorff dimension of a set A by $\mathbf{dim}_H(A)$, and the local Hausdorff dimension of A at a point $a \in A$ by $\mathbf{dim}_H^{\text{loc}}(A, a)$:

$$\mathbf{dim}_H^{\text{loc}}(A, a) = \lim_{\epsilon \rightarrow 0^+} \mathbf{dim}_H((a - \epsilon, a + \epsilon) \cap A).$$

We are now ready to state the main result of this paper.

Theorem 2.1. *Fix $J_1 > 0$. There exists $r_0 = r_0(J_1) \in (0, 1)$ such that for all J_0 satisfying $J_1/J_0 \in (1 - r_0, 1 + r_0)$, $J_0 \neq J_1$, the following statements hold.*

- i. *There exists a compact nonempty set $B_\infty(J_0, J_1) \subset \mathbb{R}$ such that $\sigma_k \xrightarrow[k \rightarrow \infty]{} B_\infty$ in the Hausdorff metric;*
- ii. *$B_\infty(J_0, J_1)$ is a Cantor set;*
- iii. *$\mathbf{dim}_H^{\text{loc}}(B_\infty(J_0, J_1), b)$ depends continuously on $b \in B_\infty(J_0, J_1)$, is non-constant and is strictly between zero and one; consequently $\mathbf{dim}_H(B_\infty(J_0, J_1)) \in (0, 1)$, and therefore the Lebesgue measure of $B_\infty(J_0, J_1)$ is zero;*
- iv. *$\mathbf{dim}_H(B_\infty(J_0, J_1))$ is continuous in the parameters (J_0, J_1) .*

Convergence of the sequence $\{\sigma_k\}$ to a (nonempty, compact) limit and multifractal nature of this limit (statements (i) and (ii) of the theorem) was observed numerically in [24, 83, 84].

We should add that we believe the restrictions on J_0, J_1 in the statement of Theorem 2.1 are not necessary; however, our present techniques do not extend to the general case (i.e. to cover all values of J_0, J_1). We record our belief here formally as a conjecture:

Conjecture 2.2. *The conclusion of Theorem 2.1 holds for all $J_0, J_1 > 0$.*

We should remark here that the Ising Hamiltonian above is equivalent, via a unitary transformation, to the tight binding model:

$$(12) \quad (\mathcal{T}\theta)_n = \tilde{J}_{n-1}\theta_{n-1} + (1 + \tilde{J}_n^2)\theta_n + \tilde{J}_{n+1}\theta_{n+1}.$$

In fact, it can be seen easily that solving (6) is equivalent to solving the equation

$$(A + B)(A - B)\phi = \lambda^2\phi.$$

This, on the other hand, is equivalent to solving

$$\mathcal{T}\phi = \lambda^2\phi.$$

Now, \mathcal{T} is a member of a family of tridiagonal Hamiltonians investigated in [82] (results of [82] were obtained some months after a preprint of the present paper appeared). From our results in [82], combined with Proposition 5.16 from Section 5.3 below, it follows that with \mathcal{T} from (12), we have $\sigma(\mathcal{T}) \subset \mathbb{R}^+$ and

$$B_\infty = \left\{ \pm\sqrt{\lambda} : \lambda \in \sigma(\mathcal{T}) \right\},$$

where $\sigma(\mathcal{T})$ is the spectrum of \mathcal{T} .

After B_∞ has been tied to the spectrum of \mathcal{T} as above, results of [2] yield a proof of statement (i) of Theorem 2.1. Moreover, in this case the restrictions given in the statement of Theorem 2.1 are not necessary; these restrictions are, however, still a necessity to our techniques for proving the remaining statements (ii)–(iv). Since previous numerical methods have relied entirely on the dynamics of the Fibonacci trace map, motivated by providing a rigorous counterpart, we provide an alternative proof of Theorem 2.1-i in Section 5.3, based entirely on dynamical properties of the trace map.

On another note, we have the following remark regarding the connection with the Jacobi operator \mathcal{T} .

Remark 2.3. In [82] it is proved (using the techniques that we develop here) that the spectrum of \mathcal{T} is a Cantor (in fact, multifractal) set of zero Lebesgue measure; moreover, we proved (heavily relying on the previous work for Schrödinger operators) that the spectral measures are purely singular continuous. The following question was justly raised by one of the referees of this article: *What implications would pure singular continuity of the spectral measures have in the context of the Ising model?* While we have not investigated this question in detail, we postulate a connection with spin-spin correlation decay, and point to [33] and references therein for some work in this direction.

3. HIERARCHY OF RESULTS

Given that the proof of Theorem 2.1 is quite technical, we provide below a diagram of lemmas, propositions and theorems, demonstrating their hierarchy, in hopes of making navigation through the technical passages of the paper easier (**T** stands for Theorem, **P** stands for Proposition, **L** stands for Lemma, and **R** stands for Remark).

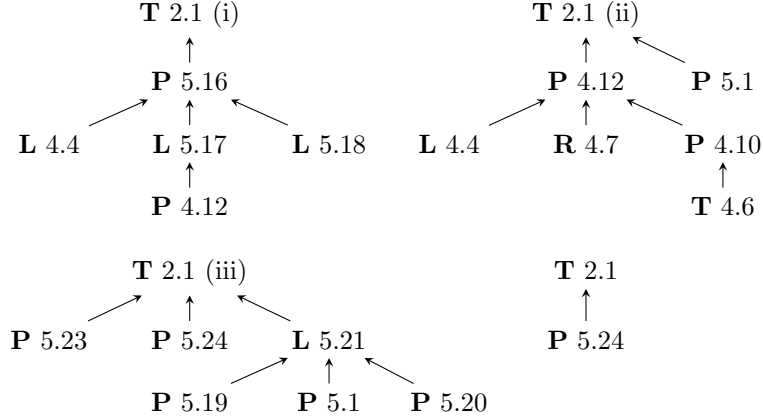

In what follows, the least transparent proof of an auxiliary result is that of Proposition 5.1. Below is a diagram illustrating its dependence on some technical lemmas.

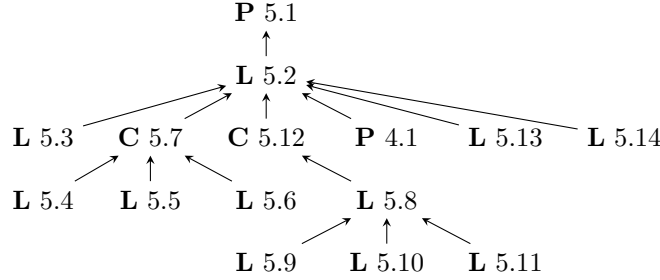

4. DYNAMICS OF THE FIBONACCI TRACE MAP

In the proof of Theorem 2.1 we shall employ dynamical properties of the Fibonacci trace map f , which we discuss in this section. For a brief overview of basic notions and notation from the theory of hyperbolic and partially hyperbolic dynamical systems, see Appendix B.2. We shall make more specific references to the appendix throughout the text, as necessary.

For convenience henceforth we shall refer to the sequence $\{f^k(x)\}_{k \in \mathbb{N}}$ as the *positive*, or *forward*, *semiorbit* of x , and denote it by $\mathcal{O}_f^+(x)$. The *negative*, or *backward*, *semiorbit* for $k \in \mathbb{Z}_{<0}$, and the *full orbit*, for $k \in \mathbb{Z}$, are defined similarly and denoted, respectively, by \mathcal{O}_f^- and $\mathcal{O}_f = \mathcal{O}_f^+ \cup \mathcal{O}_f^-$.

Define the so-called *Fricke-Vogt character* [26, 27, 78]

$$(13) \quad I(x, y, z) = x^2 + y^2 + z^2 - 2xyz - 1.$$

Consider the family of cubic surfaces $\{S_V\}_{V \geq 0}$ given by

$$(14) \quad S_V = \{\mathbf{x} \in \mathbb{R}^3 : I(\mathbf{x}) = V\}.$$

For all $V > 0$, S_V is a smooth, connected 2-dimensional submanifold of \mathbb{R}^3 without boundary. For $V = 0$, S_V has four conic singularities,

$$(15) \quad P_1 = (1, 1, 1), \quad P_2 = (-1, -1, 1), \quad P_3 = (1, -1, -1), \quad P_4 = (-1, 1, -1),$$

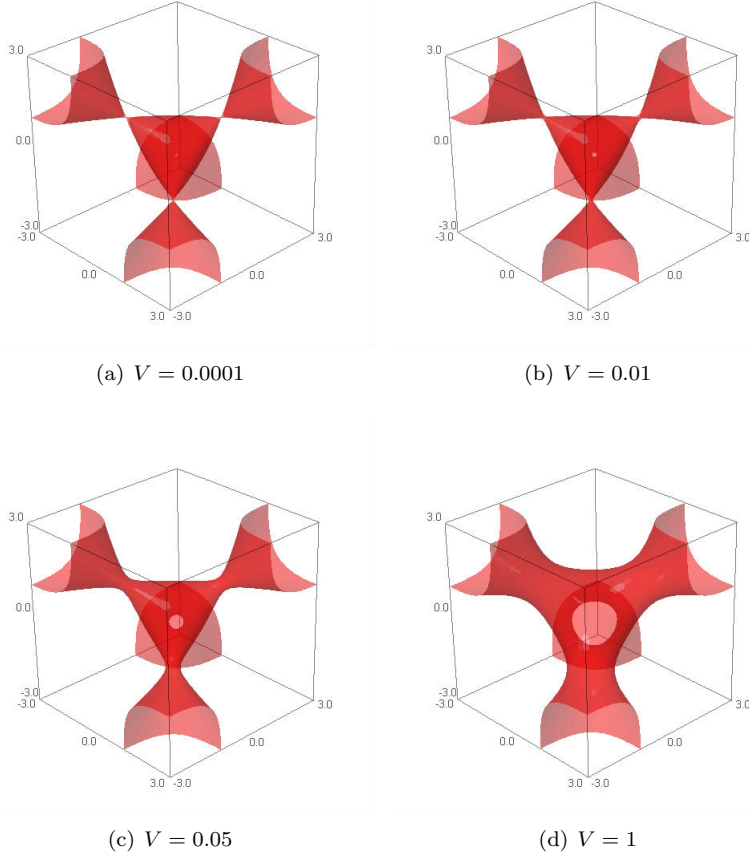
FIGURE 1. Invariant surfaces S_V for four values of V .

away from which the surface is smooth (see Figure 1).

One can easily check that f preserves the Fricke-Vogt character by verifying that $f(I(\mathbf{x})) = I(\mathbf{x})$; hence f also preserves the surfaces $\{S_V\}$ (i.e. $f : S_V \rightarrow S_V$). For convenience we shall write f_V for $f|_{S_V}$. In fact, since f is invertible with the inverse $f^{-1}(x, y, z) = (y, z, 2yz - x)$, $f : S_V \rightarrow S_V$ is an analytic diffeomorphism.

Since those points whose positive semiorbit is bounded play a crucial role in our analysis, it is convenient, for future reference, to state as a separate result the following necessary and sufficient conditions for a semiorbit to be bounded.

Proposition 4.1. *Let $x_k = \pi \circ f^k(x_1, x_0, x_{-1})$. We have the following.*

- (1) *Assume $|x_{-1}| \leq C$ for some $C \geq 1$. The sequence $\{x_k\}_{k \geq -1}$ is unbounded if and only if there exists $k_0 \geq 0$ such that*

$$|x_{k_0-1}| \leq C \quad \text{and} \quad |x_{k_0}|, |x_{k_0+1}| > C.$$

- (2) A sufficient condition for $\{x_k\}_{k \geq -1}$ to be unbounded is that there exists $k_0 \geq 0$ such that

$$|x_{k_0}|, |x_{k_0+1}| > 1 \quad \text{and} \quad |x_{k_0}| |x_{k_0+1}| > |x_{k_0-1}|.$$

Remark 4.2. As defined earlier, π denotes projection onto the third coordinate.

Proof. For the proof of (1), see, for example, [15, Proposition 5.2] (replace 1 with C). For (2), see [46, 48] ((2) also follows from the aforementioned proof of (1)). \square

Remark 4.3. For detailed analysis of orbits of trace maps, see [61].

Another result that we conveniently state as a separate statement establishes that the set of all points with bounded positive semiorbit is a closed set. This is a direct consequence of Proposition 4.1.

Lemma 4.4. *For $V_0 \geq 0$ and $\infty \geq V_1 \geq V_0$, the set of all points of $\bigcup_{V \in [V_0, V_1]} S_V$ whose forward semiorbit is bounded is a closed set.*

Proof. If $\mathcal{O}_f^+(x_1, x_0, x_{-1})$ is unbounded, then there exists a $k_0 \geq 0$ such that the point $f^{k_0}(x_1, x_0, x_{-1})$ satisfies (1) of Proposition 4.1, and hence also satisfies (2), which is an open condition. \square

Another consequence of Proposition 4.1 that will be used later is Proposition 4.5 below; for a proof see [15, Proposition 5.2], or (in a more general context) [61].

Proposition 4.5. *The positive semiorbit is unbounded if and only if $\{f^k(x)\}_{k \in \mathbb{N}}$ escapes to infinity in every coordinate.*

Most conclusions about the dynamics of f that we shall derive and use come from the knowledge of dynamics of f on the surfaces S_V , i.e. dynamics of f_V (not surprisingly, since these surfaces are invariant under f). In the following sections we recall some known results about dynamics of f_V , $V \geq 0$, as well as prove some new results necessary for the present investigation.

4.1. Dynamics of f_V for $V \geq 0$. In this and the following sections, we shall use the notation and terminology from Appendix B.

4.1.1. Hyperbolicity of f_V for $V > 0$. The following result on hyperbolicity of the Fibonacci trace map will serve as the main tool for us. For definition of a locally maximal transitive hyperbolic set (and the notion of $(1, 1)$ splitting) see Section B.1.

Theorem 4.6 (M. Casdagli in [12], D. Damanik and A. Gorodetski in [18], and S. Cantat in [11]¹). *For $V > 0$ let*

$$\Omega_V = \{p \in S_V : \mathcal{O}_f(p) \text{ is bounded}\}.$$

Then Ω_V is a Cantor set, it is f_V -invariant compact locally maximal transitive hyperbolic set in S_V (with $(1, 1)$ splitting). Moreover, Ω_V is precisely the set of nonwandering points of f_V (a point p is nonwandering if for any neighborhood U of p and $N \in \mathbb{N}$, there exists $n \geq N$ such that $f^n(U) \cap U \neq \emptyset$).

¹The special case of $V \geq 64$ was done by M. Casdagli in [12]. D. Damanik and A. Gorodetski extended the result to all $V > 0$ sufficiently small in [18]. Finally, S. Cantat proved the result for all $V > 0$ in [11] (D. Damanik and A. Gorodetski, and S. Cantat obtained their results independently, and used different techniques).

Remark 4.7. It follows that for $V > 0$, for any $x \in \Omega_V$, $W_{\text{loc}}^s(x) \cap \Omega_V$ and $W_{\text{loc}}^u(x) \cap \Omega_V$ are Cantor sets ($W_{\text{loc}}^s(x)$ denotes the local stable manifold at x , and $W_{\text{loc}}^u(x)$ denotes the local unstable manifold at x – see Appendix B.1.2 for definitions and properties of these objects).

Remark 4.8. In fact, f_V satisfied what is called *Smale's Axiom A* [68]. The general theory of Axiom A diffeomorphisms is extensive and forms one of the central themes in the modern theory of dynamical systems. Suffice it to say that Axiom A diffeomorphisms are the hallmark of chaotic dynamics.

The preceding theorem is of importance, because as a consequence of it, the set of points whose forward semiorbit is bounded can be endowed with a sensible geometric structure, which is the subject of Corollary 4.9 below. The corollary follows from general principles in hyperbolic dynamics (and has been employed implicitly in a number of previous works, especially [12,18]; for the technical details, see Corollary 2.5 and the discussion preceding it in [21]. In the statement of the corollary, $W^s(\Omega_V)$ stands for $\bigcup_{x \in \Omega_V} W^s(x)$, where $W^s(x)$ is the global stable manifold (in contrast to the local one from Remark 4.7 above). For details, see equations (49) and (50) in Section B.1.2.

Corollary 4.9. *For $V > 0$, $x \in S_V$, $\mathcal{O}_f^+(x)$ is bounded if and only if $x \in W^s(\Omega_V)$.*

4.1.2. *Dynamics of f_V for $V = 0$.* As mentioned above, the surface S_0 is smooth everywhere except for the four singularities P_1, \dots, P_4 (see (15) and Figure 1). Let us set, and henceforth fix, the following notation

$$(16) \quad \mathbb{S} = \{(x, y, z) \in S_0 : |x|, |y|, |z| \leq 1\}.$$

It is easily seen that \mathbb{S} is invariant under f . Moreover, $f|_{\mathbb{S}}$ is a factor of the hyperbolic diffeomorphism on \mathbb{T}^2 ,

$$(17) \quad \mathcal{A}(\theta, \phi) = ((\theta + \phi), \theta) \pmod{1},$$

via the factor map

$$(18) \quad F : (\theta, \phi) \mapsto (\cos 2\pi(\theta + \phi), \cos 2\pi\theta, \cos 2\pi\phi).$$

By a *factor* we mean

$$f|_{\mathbb{S}} \circ F = F \circ \mathcal{A}.$$

The map F is not, however, a conjugacy in the sense of (48) from Section B.1.2, since F is a two-to-one map. The dynamics of f on $\{P_1, \dots, P_4\}$ is as follows.

$$f : P_1 \mapsto P_1; \quad f : P_2 \mapsto P_3 \mapsto P_4 \mapsto P_2.$$

It is easy to see that $\mathcal{A} : \mathbb{T}^2 \rightarrow \mathbb{T}^2$ is a hyperbolic map with the full space \mathbb{T}^2 constituting a compact hyperbolic set (such systems are more commonly known as *Anosov diffeomorphisms*). Even though $F : \mathcal{A} \rightarrow \mathbb{S}$ is not a conjugacy, the behavior of Df on the tangent bundle of \mathbb{S} away from the singularities P_1, \dots, P_4 still inherits the hyperbolic behavior from $D\mathcal{A}$ via DF (this is stated more precisely in Lemma 5.3 below). However, the singularities (or, better to say, dynamics near the singularities) requires special treatment. We now concentrate on a neighborhood of P_1 ; similar results hold for the other singularities due to the symmetries of f (see Section A.2 for details).

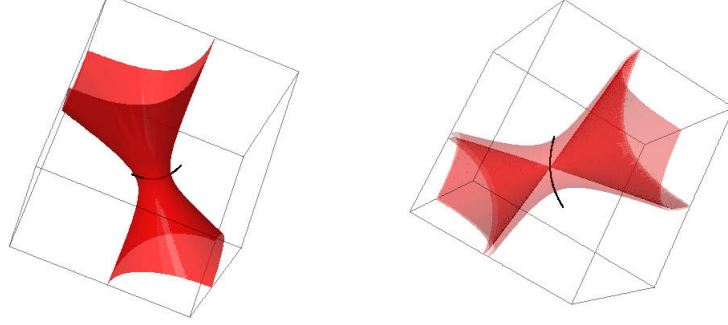
FIGURE 2. $\text{Per}_2(f)$ in a neighborhood of P_1 .

Let $\text{Per}_2(f)$ denote the set of period-two periodic points for f (note that $\text{Per}_2(f)$ is precisely what is called ρ_1 in Section A.1). A direct computation shows that

$$\text{Per}_2(f) = \left\{ (x, y, z) : x \in \left(-\infty, \frac{1}{2}\right) \cup \left(\frac{1}{2}, \infty\right), y = \frac{x}{2x-1}, z = x \right\}.$$

Let

$$(19) \quad \vartheta(x) = \left(x, \frac{x}{2x-1}, x\right), \quad \vartheta : \left(-\infty, \frac{1}{2}\right) \cup \left(\frac{1}{2}, \infty\right) \rightarrow \mathbb{R}^3$$

be the curve of these periodic points (see Figure 2). We have Also,

$$(20) \quad I(\vartheta(x)) \geq 0,$$

with $I(\vartheta(x)) = 0$ if and only if $x = 1$, where $\vartheta(1) = P_1$. On the other hand,

$$Df_{P_1} = \begin{pmatrix} 2 & 2 & -1 \\ 1 & 0 & 0 \\ 0 & 1 & 0 \end{pmatrix} \quad \text{which is similar to} \quad \begin{pmatrix} \frac{3-\sqrt{5}}{2} & 0 & 0 \\ 0 & -1 & 0 \\ 0 & 0 & \frac{3+\sqrt{5}}{2} \end{pmatrix}.$$

Hence $T_{P_1}\mathbb{R}^3$ splits as

$$(21) \quad T_{P_1}\mathbb{R}^3 = E_{P_1}^s \oplus E_{P_1}^c \oplus E_{P_1}^u,$$

where $E_{P_1}^s$ corresponds to the subspace spanned by the eigenvector corresponding to the largest eigenvalue of Df (which is strictly larger than one), $E_{P_1}^u$ corresponds to the subspace spanned by the eigenvector of Df_{P_1} corresponding to the smallest eigenvalue of Df (which is the reciprocal of the largest one), and $E_{P_1}^c$ corresponds to the subspace spanned by the eigenvector of Df_{P_1} corresponding to the eigenvalue 1, which is also the tangent space of $\text{Per}_2(f)$ at the point P_1 (see Section A.1 for a slightly more detailed discussion). Now using invariance of $\text{Per}_2(f)$ under f , and combining (20) with Theorem 4.6 for $x \neq 1$ and (21) for $x = 1$, we get that the curve ϑ is normally hyperbolic in a neighborhood of P_1 (for definitions and properties, see Section B.3). Hence we can apply Theorem B.2 and, in the notation of Section B.3 (see equation (54)), we get that $W_{\text{loc}}^{\text{cs}}(\text{Per}_2(f))$ and $W_{\text{loc}}^{\text{cu}}(\text{Per}_2(f))$ are smooth two-dimensional submanifolds of \mathbb{R}^3 (roughly speaking, the manifold $W_{\text{loc}}^{\text{cs}}(\text{Per}_2(f))$ is precisely the set of those points of \mathbb{R}^3 which lie in some ϵ -neighborhood of $\text{Per}_2(f)$

and whose positive semiorbit does not leave this neighborhood, and similarly for $W_{\text{loc}}^{\text{cu}}(\text{Per}_2(f))$ with f replaced by f^{-1} ; more details are given in Section B.3). Moreover, by invariance of the surfaces S_V under f , it follows that $W_{\text{loc}}^{\text{cs,cu}}(\text{Per}_2(f)) \cap S_V$ is precisely the one-dimensional manifold $W_{\text{loc}}^{\text{s,u}}(\text{Per}_2(f) \cap S_V)$ on S_V (see Sections B.1.2 and B.3), for $V > 0$. When $V = 0$, $W_{\text{loc}}^{\text{cs,cu}}(\text{Per}_2(f)) \cap S_0 \setminus \{P_1\}$ forms the local strong-stable/unstable one-dimensional submanifold (as defined in equation (52) of Section B.3) on S_0 consisting of two smooth branches that connect smoothly (when viewed as submanifolds of \mathbb{R}^3) at P_1 . Points of the strong-stable manifold converge to P_1 under iterations of f ; the same happens under iterations of f^{-1} for points on the strong-unstable manifold. The strong-stable and strong-unstable manifolds intersect at P_1 .

We have

$$\frac{d(I \circ \vartheta)}{dx} \neq 0$$

for all $x \neq 1$. Hence ϑ , and therefore also $W_{\text{loc}}^{\text{cs,cu}}(\text{Per}_2(f))$, intersect S_V transversely for $V > 0$. On the other hand, $W_{\text{loc}}^{\text{cs,cu}}(\text{Per}_2(f))$ has quadratic tangency with S_0 along the strong-stable/unstable submanifold (see also [18, Section 4]). This is a crucial point to make, since the proof of Theorem 2.1 relies heavily on transversality of intersection of the line of initial conditions, $\gamma_{(J_0, J_1)}$, from (10), with $W^{\text{cs}}(\text{Per}_2(f))$ (which is defined below). In order to prove transversality, we proceed by perturbation analysis starting with $\gamma_{(J_0, J_1)}$ with $J_0 = J_1$. In this case γ lies on S_0 , and since $W^{\text{cs}}(\text{Per}_2(f))$ is tangent to S_0 , γ is tangent to $W^{\text{cs}}(\text{Per}_2(f))$ (this shows in particular that proving transversality for $J_0 \neq J_1$ is not a trivial task). We then show that if J_0/J_1 is close to 1, and not equal to 1, $\gamma_{(J_0, J_1)}$ is transversal to $W^{\text{cs}}(\text{Per}_2(f))$. The situation is further complicated by the fact that we do not have any explicit, or quantitative, knowledge about $W^{\text{cs}}(\text{Per}_2(f))$, and must rely only on qualitative analysis.

The manifolds $W_{\text{loc}}^{\text{cs}}(\text{Per}_2(f))$ and $W_{\text{loc}}^{\text{cu}}(\text{Per}(f))$ can be extended globally to

$$W^{\text{cs}}(\text{Per}_2(f)) = \bigcup_{n \in \mathbb{N}} f^{-n}(W_{\text{loc}}^{\text{cs}}(\text{Per}_2(f)))$$

and

$$W^{\text{cu}}(\text{Per}_2(f)) = \bigcup_{n \in \mathbb{N}} f^n(W_{\text{loc}}^{\text{cu}}(\text{Per}_2(f))).$$

In this case $W^{\text{s,u}}(\text{Per}_2(f) \cap S_V) = W^{\text{cs,cu}}(\text{Per}_2(f)) \cap S_V$ for $V > 0$. For $V = 0$, these form branches of global strong-stable and strong-unstable submanifolds of S_0 that connect at P_1 - these branches are injectively immersed one-dimensional submanifolds of S_0 .

Similar results hold for P_2, P_3, P_4 . Indeed, as V takes on positive values, the points P_2, P_3 and P_4 bifurcate from three cycles to six cycles. These six cycles form three smooth curves, one through each P_2, P_3 and P_4 . Considering f^6 in place of f , it is easy to show, as in the case of P_1 above, that each curve is normally hyperbolic. For further details, refer to Section A.1.

Let us fix the following notation. Denote by $\mathbb{W}_i^{\text{s,u}}$ the center-stable/unstable 2-dimensional invariant manifold to the normally hyperbolic curve through P_i . We denote by $\mathbb{W}_{i,\text{loc}}^{\text{s,u}}$ a small neighborhood of the normally hyperbolic curve in $\mathbb{W}_i^{\text{s,u}}$. As an aside, we should mention that in fact the normally hyperbolic curve is precisely $\mathbb{W}_{i,\text{loc}}^{\text{s}} \cap \mathbb{W}_{i,\text{loc}}^{\text{u}}$, provided that the neighborhood $\mathbb{W}_{i,\text{loc}}^{\text{s,u}}$ is taken sufficiently small,

and this intersection is transversal (we should note that there exist, in fact *infinitely many*, other intersections between \mathbb{W}_i^s and \mathbb{W}_i^u).

In particular, the orbit $\mathcal{O}_{f_0}^+(x)$ (respectively, $\mathcal{O}_{f_0}^-(x)$), for $x \in S_0$, is bounded if and only if either $x \in \mathbb{S}$ or $x \in \mathbb{W}_i^s \cap S_0$ (respectively, $x \in \mathbb{W}_i^u \cap S_0$) for some $i \in \{1, \dots, 4\}$.

4.2. Partial hyperbolicity: center-stable and center-unstable manifolds.

In the previous section we proved normal hyperbolicity of f on certain submanifolds (namely, the curves of periodic points through the singularities) and derived the existence of two-dimensional analogs of stable and unstable manifolds. The result of the previous section is a special case of a more general fact, which is the subject of Proposition 4.10. For the definition of a *partially hyperbolic set* (as well as the notion of $(1, 1, 1)$ splitting), see Section B.2. Note also that the results of the previous section cannot be encapsulated into the following proposition, because in what follows, the results are stated for surfaces S_V , $V > 0$; due to presence of singularities P_1, \dots, P_4 in S_0 , we had to treat the case of S_0 separately.

Proposition 4.10. *Let*

$$\mathcal{M} = \bigcup_{V \in (0, \infty)} S_V.$$

For $V_1 \geq V_0 > 0$ let

$$\Omega = \bigcup_{V \in [V_0, V_1]} \Omega_V.$$

Then \mathcal{M} is a smooth, connected, f -invariant 3-dimensional submanifold of \mathbb{R}^3 , $\Omega \subset \mathcal{M}$ is compact, f -invariant partially hyperbolic set with $(1, 1, 1)$ splitting, and the following holds.

There exist two families, denoted by \mathcal{W}^s and \mathcal{W}^u , of smooth 2-dimensional connected manifolds injectively immersed in \mathcal{M} , whose members we denote by, respectively, W^{cs} and W^{cu} , and call center-stable and center-unstable manifolds, with the following properties.

- (1) The family $\mathcal{W}^{s,u}$ is f -invariant;
- (2) For every $x \in \Omega$ there exist unique $W^{cs}(x) \in \mathcal{W}^s$ and $W^{cu}(x) \in \mathcal{W}^u$ such that $x \in W^{cs}(x) \cap W^{cu}(x)$;
- (3) Conversely, for every $W^{cs} \in \mathcal{W}^s$ and $W^{cu} \in \mathcal{W}^u$, there exist $x, y \in \Omega$ such that $x \in W^{cs}$ and $y \in W^{cu}$. In fact, if $W_1^{cs}, W_2^{cs} \in \mathcal{W}^s$ and $W_1^{cu}, W_2^{cu} \in \mathcal{W}^u$ with $W_1^{cs} \cap W_2^{cs} \neq \emptyset$ and $W_1^{cu} \cap W_2^{cu} \neq \emptyset$, then $W_1^{cs} = W_2^{cs} = W^{cs}(x)$ for some $x \in \Omega$, and $W_1^{cu} = W_2^{cu} = W^{cu}(y)$ for some $y \in \Omega$.
- (4) For any $V > 0$ and any $W^{cs,cu} \in \mathcal{W}^{s,u}$, $W^{cs,cu} \cap S_V = W^{s,u}(x)$ for every $x \in \Omega_V \cap W^{cs,cu}$; moreover, this intersection is transversal.

Proof. All statements about \mathcal{M} , as well as compactness of Ω , are trivially true. The surfaces $\{S_V\}$, $V > 0$, are all diffeomorphic. Fix $\tilde{V} > 0$, and let $\pi_V : S_{\tilde{V}} \rightarrow S_V$ be a diffeomorphism, depending smoothly on V , with $\pi_{\tilde{V}} = \text{Id}|_{S_{\tilde{V}}}$. Now, after a smooth change of coordinates, $f : \mathcal{M} \rightarrow \mathcal{M}$ may be considered as a skew product of identity on an interval I with a map on $S_{\tilde{V}}$:

$$\begin{array}{ccc}
I \times S_{\tilde{V}} & \xrightarrow{\mathcal{G}} & I \times S_{\tilde{V}} \\
\tilde{\pi} \downarrow & & \downarrow \tilde{\pi} \\
\bigcup_V S_V & \xrightarrow{f} & \bigcup_V S_V
\end{array}$$

where $\tilde{\pi}(V, x) = \pi_V(x)$, and $\mathcal{G}(V, x) = (V, \tilde{\pi}^{-1} \circ f \circ \tilde{\pi}(V, x))$. Now all statements about Ω follow from Theorem 4.6 (in particular, noting that $\Omega_{\tilde{V}}$ is hyperbolic).

We now construct the family \mathcal{W}^s . The family \mathcal{W}^u can be constructed similarly by considering f^{-1} in place of f .

Fix $\tilde{V} > 0$ and $x \in \Omega_{\tilde{V}}$. Take $\delta > 0$ small (in particular so that $\tilde{V} - \delta > 0$) and for $V \in [\tilde{V} - \delta, \tilde{V} + \delta]$ let $H_V : \Omega_{\tilde{V}} \rightarrow \Omega_V$ be the topological conjugacy (see Section B.1.1). Then $W_{\text{loc}}^{\text{cs}}(x) = \bigcup_{V \in (\tilde{V} - \delta, \tilde{V} + \delta)} W_{\text{loc}}^{\text{cs}}(H_V(x))$ is a smooth two-dimensional manifold (see [36, Section 6] for proof of smoothness) that can be extended to all V , and the sought $W^{\text{cs}}(x)$ is then given by

$$W^{\text{cs}}(x) = \bigcup_{n \in \mathbb{N}} f^{-n}(W_{\text{loc}}^{\text{cs}}(x)).$$

The collection $\{W^{\text{cs}}(x)\}_{x \in \Omega_{\tilde{V}}}$ gives the family \mathcal{W}^s .

Fix $x \in \Omega$ and consider the curve $V \mapsto H_V(x)$ in a neighborhood of x . This curve is the intersection of $W_{\text{loc}}^{\text{cs}}(x)$ with $W_{\text{loc}}^{\text{cu}}(x)$, hence is smooth. Since f_V depends smoothly, and hence Lipschitz-continuously (when restricted to a compact subset), on V , by [34, Theorem 7.3], H_V is the fixed point of a contracting map on a certain Banach space that depends Lipschitz-continuously on V . So by [34, Theorem 1.1], if $V_0 > 0$ is fixed, there exists $C > 0$ such that for all V close to V_0 ,

$$\frac{\|H_V(x) - H_{V_0}(x)\|}{|V - V_0|} \leq C,$$

proving transversality of intersection of $\{H_V(x)\}_V$ with S_{V_0} . Hence $W^{\text{cs}, \text{cu}}(x)$ intersects S_V , $V > 0$, transversely, as claimed. \square

Remark 4.11. From the proof of Proposition 4.10 and Section B.1.2 it is evident that the local center-stable and center-unstable manifolds at x , $W_{\text{loc}}^{\text{cs}}(x)$ and $W_{\text{loc}}^{\text{cu}}(x)$, depend continuously on the point x in the C^1 topology. Consequently, by compactness we obtain uniform (in x) transversality of $W_{\text{loc}}^{\text{cs}, \text{cu}}(x)$ with the surface S_V , $V > 0$.

As a consequence of Proposition 4.10, we obtain

Proposition 4.12. *Let \mathcal{M} be as in Proposition 4.10. Suppose $\gamma : [0, 1] \rightarrow \mathcal{M}$ is smooth and regular. Suppose further that γ intersects the members of \mathcal{W}^s transversely with its endpoints not lying on center-stable manifolds. Then the set of all points $x \in [0, 1]$ for which $\mathcal{O}_f^+(f \circ \gamma(x))$ is bounded is a Cantor set.*

Proof. By construction of the center-stable manifolds, for $s \in [0, 1]$, $\gamma(s)$ has a bounded forward orbit if and only if $\gamma(s)$ belongs to a center-stable manifold.

Compactness follows from Lemma 4.4. Now absence of isolated points and total disconnectedness follow from Remark 4.7 and Proposition 4.10. \square

We are ready to prove Theorem 2.1.

5. PROOF OF MAIN RESULTS

In this section we prove Theorem 2.1. The proof of the theorem is inherently technical and involves nontrivial notions from the theory of hyperbolic and partially hyperbolic dynamical systems. To make the reading easier where possible, we have included as a separate section the necessary notions from the theory of dynamical systems in Appendix B. Throughout this section, references are made to the appendix where appropriate. The reader is also advised to use Section 3 as a road map.

5.1. A short comparison and contrast with Schrödinger operators. Those readers who are familiar with the results and methods of spectral theory of discrete one-dimensional quasi-periodic Schrödinger operators may justly inquire as to why we couldn't simply apply the methods that have already been developed for Schrödinger operators (see [16] for a broad overview). To answer this question, let us quickly recall the setup for the Schrödinger operator, denoted by H . The operator acts on $\ell^2(\mathbb{Z})$ as

$$(H\phi)_n = \phi_{n-1} + \phi_{n+1} + V\omega_n\phi_n,$$

where $V \in \mathbb{R}$, and ω is the sequence obtained by performing the Fibonacci substitution on the letters 0 and 1, starting with, say, $0: 0 \mapsto 01 \mapsto 010 \mapsto 01001 \mapsto \dots$. This sequence can then be naturally extended to the left. For details, see the recent survey [16] and references therein. It turns out that there exists $\gamma: \mathbb{R} \rightarrow \mathbb{R}^2$, explicitly given by

$$\gamma(E) = \left(\frac{E-V}{2}, \frac{E}{2}, 1 \right),$$

such that E belongs to the spectrum of H if and only if $\mathcal{O}_f^+(\gamma(E))$ is bounded. On the other hand, we have $I(\gamma(E)) = V^2/4$, which is clearly independent of E and is non-negative (and is zero if and only if $V = 0$, which corresponds to the *free Laplacian* case, whose spectrum is $[-2, 2]$). Thus the action of f needs to be considered only on one surfaces, $S_{V^2/4}$, for any chosen and fixed $V > 0$ (this is not to say that the problem is trivial – far from it!). In our case, however, as we shall soon see, the value of the invariant I depends on the spectral parameter, forcing us to consider the action of f on all $S_{V \geq 0}$ at once. It turns out that this is also what is responsible for multifractality (i.e. nonuniform local scaling properties) of the spectrum (in contrast to the case of Schrödinger operators). Let us conclude by mentioning that we have encountered the same difficulties (with the same consequences of multifractality) in a few other models (see [21, 80, 82]).

5.2. Preliminary technical platform. The appearance of λ^2 in $\gamma_{(J_0, J_1)}$ in (10) makes γ symmetric in λ with respect to the origin. By abuse of notation, let us write λ in place of λ^2 , where λ is allowed to take values in $[0, \infty)$.

Take $r = J_0/J_1$ and, for convenience, let us also write γ_r in place of $\gamma_{(J_0, J_1)}$. Hence

$$(22) \quad \gamma_r(\lambda) = \left(\frac{\lambda - (1 + J_1^2)}{2J_1}, \frac{\lambda - (1 + r^2 J_1^2)}{2rJ_1}, \frac{1 + r^2}{2r} \right).$$

Proposition 5.1. *For every $J_1 > 0$, there exists $r_0 = r_0(J_1) \in (0, 1)$, such that for all $r \in (1 - r_0, 1 + r_0)$ and $r \neq 1$, the curve γ_r in (22) intersects the center-stable manifolds transversely.*

Proof. We begin by showing that γ_r intersects uniformly transversely the manifolds \mathbb{W}_i^s , $i \in \{1, \dots, 4\}$. We shall see later (actually, we won't prove this but point to the work of S. Cantat [11]) that \mathbb{W}_i^s , for $i \in \{1, \dots, 4\}$, form a dense (in the C^1 topology) subfamily of the family \mathcal{W}^s from Proposition 4.10, and the conclusion of Proposition 5.1 will follow. We shall then combine this result with Proposition 4.12.

Lemma 5.2. *For all r sufficiently close to one and not equal to one, γ_r intersects \mathbb{W}_i^s , for $i \in \{1, \dots, 4\}$, uniformly transversely.*

Proof. Returning to the map \mathcal{A} in (17), we see that \mathcal{A} is hyperbolic and is given by the matrix $A = \begin{pmatrix} 1 & 1 \\ 1 & 0 \end{pmatrix}$ with eigenvalues

$$\mu = \frac{1 + \sqrt{5}}{2} \quad \text{and} \quad -\mu^{-1} = \frac{1 - \sqrt{5}}{2}.$$

Let us denote by $\mathbf{v}^s, \mathbf{v}^u \in \mathbb{R}^2$ the stable and unstable eigenvectors of A :

$$A\mathbf{v}^s = -\mu^{-1}\mathbf{v}^s, \quad A\mathbf{v}^u = \mu\mathbf{v}^u, \quad \|\mathbf{v}^{s,u}\| = 1.$$

Fix some small $\zeta > 0$ (in general we want $\zeta < 1$) and define the stable and unstable cone fields on \mathbb{R}^2 in the following way:

$$(23) \quad \begin{aligned} K^s(p) &= \{ \mathbf{v} \in T_p\mathbb{R}^2 : \mathbf{v} = v^u\mathbf{v}^u + v^s\mathbf{v}^s, |v^s| \geq \zeta^{-1}|v^u| \}, \\ K^u(p) &= \{ \mathbf{v} \in T_p\mathbb{R}^2 : \mathbf{v} = v^u\mathbf{v}^u + v^s\mathbf{v}^s, |v^u| \geq \zeta^{-1}|v^s| \}. \end{aligned}$$

These cone fields are invariant:

$$A(K_p^u) \subset \text{Int}(K^u(Ap)) \quad \text{and} \quad A^{-1}(K^s(p)) \subset \text{Int}(K^s(A^{-1}p)).$$

Also, the iterates of the map A expand vectors from the unstable cones, and the iterates of the map A^{-1} expand vectors from the stable cones. That is, there exists a constant $C > 0$ such that

$$\begin{aligned} \forall \mathbf{v} \in K^u(p) \quad \forall n \in \mathbb{N} \quad \|A^n \mathbf{v}\| &> C\mu^n \|\mathbf{v}\|, \\ \forall \mathbf{v} \in K^s(p) \quad \forall n \in \mathbb{N} \quad \|A^{-n} \mathbf{v}\| &> C\mu^n \|\mathbf{v}\|. \end{aligned}$$

The families of cones $\{K^s(p)\}_{p \in \mathbb{R}^2}$ and $\{K^u(p)\}_{p \in \mathbb{R}^2}$ can also be considered on $\mathbb{T}^2 = \mathbb{R}^2/\mathbb{Z}^2$.

The differential of the semiconjugacy F in (18), DF , sends these cone families to Df -invariant stable and unstable cone families on $\mathbb{S} \setminus \{P_1, \dots, P_4\}$. Let us denote these images by $\{\mathcal{K}^s\}$ and $\{\mathcal{K}^u\}$, respectively. It is clear that away from a neighborhood of singularities, the cones $\mathcal{K}^{s,u}$ have nonzero size. The following lemma states that the size of these cones is uniformly bounded away from zero on $\mathbb{S} \setminus \{P_1, \dots, P_4\}$.

Lemma 5.3 ([18, Lemma 3.1]). *The differential of the semiconjugacy DF induces a map of the unit bundle of \mathbb{T}^2 to the unit bundle of $\mathbb{S} \setminus \{P_1, \dots, P_4\}$. The derivatives of the restrictions of this map to a fiber are uniformly bounded. In particular, the sizes of cones in families $\{\mathcal{K}^s\}$ and $\{\mathcal{K}^u\}$ are uniformly bounded away from zero.*

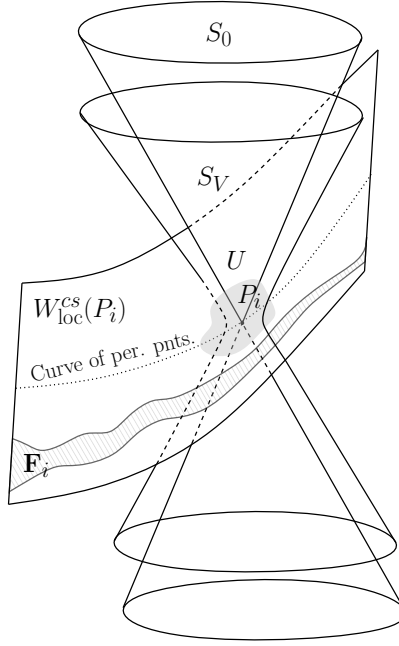

FIGURE 3.

Fix $j_0 \in \{1, \dots, 4\}$. Let α be a smooth curve in $\mathbb{W}_{j_0}^s$ that is C^1 close to, and disjoint from, the curve of periodic points through the singularity P_{j_0} . Assume also that $\alpha \cap S_0 \in \mathbb{S}$. Let \mathbb{F}_{j_0} be the fundamental domain in $\mathbb{W}_{j_0}^s$ bounded by α and $f^{-1}(\alpha)$ (for the definition of a fundamental domain, see Section B.1.3). Let U be a neighborhood of $\{P_1, \dots, P_4\}$ in \mathbb{R}^3 so small, that $U \cap \mathbb{F}_{j_0} = \emptyset$ (see Figure 3).

Given $V_0 > 0$ sufficiently small, for all $V \in [0, V_0)$, the surface $S_V \setminus U$ consists of five smooth connected components (with boundary), one of which is compact. Let $\mathbb{S}_{V,U}$ denote the compact component. The family $\{\mathbb{S}_{V,U}\}_{V \in [0, V_0)}$ depends smoothly on V , that is, there exists a family of smooth projections, depending smoothly on V :

$$\{\pi_V : \mathbb{S}_{0,U} \rightarrow \mathbb{S}_{V,U}\}_{V \in [0, V_0)}, \quad \pi_0 = \text{Id}_{\mathbb{S}_{0,U}}.$$

Assuming V_0 is sufficiently small, $D\pi_V$ carries the cones $\{\mathcal{K}^{s,u}\}$ to nonzero cones on $\mathbb{S}_{V,U}$; denote these cones by $\{\mathcal{K}_V^{s,u}\}$.

In the next series of lemmas we shall construct in some special way some families of cone fields and show that they are invariant under the action by Df . The reason for doing this is the following. As we have already mentioned, we do not have any quantitative information about \mathbb{W}_i^s . In particular, we cannot check directly whether the given line, γ_r , is transversal to \mathbb{W}_i^s . However, based on qualitative properties of \mathbb{W}_i^s and quantitative information that *we do have* about the surfaces S_V , $V \geq 0$, and the line γ_r , we can construct a cone field with the following properties.

- This cone field is transversal to \mathbb{W}_i^s at points in the set $\mathbb{F}_i \cap S_V$ for all $V > 0$ sufficiently small (here we use quadratic tangency of \mathbb{W}_i^s with S_0);
- The line γ_r falls inside this cone field for all r sufficiently close to 1 (we can check this directly from the explicit expression of γ);

- This cone field is invariant under the action by Df (we use both, the geometry of S_V and some dynamical properties of f).

We then take any point in $\gamma_r \cap \mathbb{W}_i^s$, say $\gamma_r(x)$, and iterate it by f until it falls inside \mathbb{F}_i ; say $f^k(\gamma_r(x)) \in \mathbb{F}_i$. By the invariance of the constructed cone field, we must then have $Df^k(\gamma_r(x))$ inside the cone at $f^k(x)$, which is transversal to \mathbb{W}_i^s . Thus $\gamma_r(x)$ must have been transversal to $T_{\gamma_r(x)}\mathbb{W}_i^s$ to begin with.

Below, Lemmas 5.4, 5.5 and 5.6 establish invariance of $\{\mathcal{K}_V^{s,u}\}$, as well as scaling properties of vectors from these cones under the action by Df , by considering different cases. The final result is recorded in Corollary 5.7.

Lemma 5.4. *For all $N \in \mathbb{N}$ there exists $V_0 > 0$ sufficiently small such that for all $k \in \mathbb{Z}_{\geq 0}$ with $k \leq N$ and all $V \in [0, V_0)$, if $x \in \mathbb{S}_{V,U}$ and $f^k(x) \in \mathbb{S}_{V,U}$, then*

$$Df_x^k(\mathcal{K}_V^u(x)) \subset \text{Int}(\mathcal{K}_V^u(f^k(x))).$$

Proof. Since π_V depends smoothly on V , for $x \in \mathbb{S}_{0,U}$, the cones $\mathcal{K}^u(x)$ and $\mathcal{K}_V^u(\pi_V(x))$ are close provided that V is close to zero. Since f_V depends smoothly on V , Df_V^k and Df_0^k are close. In particular, for a given $x \in \mathbb{S}_{0,U}$ with $f^k(x) \in \mathbb{S}_{0,U}$, if $\pi_V(x) \in \mathbb{S}_{V,U}$ and $f^k(\pi_V(x)) \in \mathbb{S}_{V,U}$, then $Df_V^k(\mathcal{K}_V^u(\pi_V(x)))$ and $Df^k(\mathcal{K}^u(x))$ are close. Thus by compactness of the surfaces $\mathbb{S}_{V,U}$, we can choose V_0 suitably small, so that the conclusion of the Lemma holds. \square

Lemma 5.5 ([18, Lemma 5.4]). *Assuming U is sufficiently small, there exists sufficiently large $N \in \mathbb{N}$ and sufficiently small $V_0 > 0$, such that for all $V \in [0, V_0)$ the following holds. If $x \in \mathbb{S}_{V,U}$ and k is the smallest number such that $f^k(x) \in \mathbb{S}_{V,U}$ and $k \geq N$, then*

$$Df_x^k(\mathcal{K}_V^u(x)) \subset \text{Int}(\mathcal{K}_V^u(f^k(x))).$$

Lemma 5.6 ([18, Lemma 5.2]). *There exists $V_0 > 0$ sufficiently small, $C > 0$ and $\mu > 1$, such that for all $V \in [0, V_0)$ the following holds. If $x \in \mathbb{S}_{V,U}$ and for $k \in \mathbb{N}$, $f^k(x) \in \mathbb{S}_{V,U}$, and if $\mathbf{v} \in \mathcal{K}_V^u(x)$, then*

$$\|Df_x^k(\mathbf{v})\| \geq C\mu^k \|\mathbf{v}\|.$$

Combination of Lemmas 5.4, 5.5, 5.6 gives

Corollary 5.7. *Assuming U is small, there exists $V_0 > 0$ sufficiently small, $C > 0$ and $\mu > 1$ such that for all $V \in [0, V_0)$, the following holds. If $x \in \mathbb{S}_{V,U}$, $\mathbf{v} \in \mathcal{K}_V^u(x)$, $k \in \mathbb{N}$ and $f^k(x) \in \mathbb{S}_{V,U}$, then*

$$Df_x^k(\mathcal{K}_V^u(x)) \subset \text{Int}(\mathcal{K}_V^u(f^k(x))) \quad \text{and} \quad \|Df_x^k(\mathbf{v})\| \geq C\mu^k \|\mathbf{v}\|.$$

With U and V_0 satisfying the hypothesis of Corollary 5.7, let us construct the following cone field on $\mathbb{S}_{V,U}$, for $V \in [0, V_0)$ and $\eta > 0$:

$$(24) \quad K_V^\eta(x) = \left\{ (\mathbf{u}, \mathbf{v}) \in T_x \mathbb{S}_{V,U} \oplus (T_x \mathbb{S}_{V,U})^\perp : \mathbf{u} \in \mathcal{K}_V^u(x), \|\mathbf{v}\| \leq \eta\sqrt{V}\|\mathbf{u}\| \right\}.$$

The cone field from (24) is of central importance, as it is the one that will be shown to be transversal to \mathbb{W}_i^s , and to contain the line γ_r . However, as it is defined, it may not be invariant in the sense of the preceding corollary. The next lemma establishes that it is *almost invariant* (which is enough for us).

Lemma 5.8. *For every $\hat{\eta} > 0$ there exists $\eta = \eta(\hat{\eta}) > 0$, $\eta < \hat{\eta}$, and $V_0 > 0$ sufficiently small, such that for any $V \in [0, V_0)$, any $x \in \mathbb{S}_{V,U}$, $k \in \mathbb{Z}_{\geq 0}$, if $f^k(x) \in \mathbb{S}_{V,U}$, then*

$$Df_x^k(K_V^\eta(x)) \subset K_V^{\hat{\eta}}(f^k(x)).$$

Proof. Smooth dependence of the surfaces $\{S_V\}_{V>0}$ on V and invariance under f implies the following.

Lemma 5.9. *For any $V > 0$, $x \in S_V$ and $k \in \mathbb{Z}$, if $\mathbf{v} \in (T_x S_V)^\perp$, then*

$$(25) \quad \left\| \mathbf{Proj}_{(T_{f^k(x)} S_V)^\perp} (Df_x^k(\mathbf{v})) \right\| = \frac{\|\nabla I(x)\|}{\|\nabla I(f^k(x))\|} \|\mathbf{v}\|,$$

where ∇I is the gradient of the Fricke-Vogt character (see (13)). In particular, there exists $D > 0$ such that for all $V \in (0, V_0)$ and any $x \in \mathbb{S}_{V,U}$, if $f^k(x) \in \mathbb{S}_{V,U}$, then for every $\mathbf{v} \in (T_x S_V)^\perp$, we have

$$\left\| \mathbf{Proj}_{(T_{f^k(x)} S_{V,U})^\perp} (Df_x^k(\mathbf{v})) \right\| \leq D \|\mathbf{v}\|.$$

In fact, we can take

$$D = \sup \left\{ \frac{\|\nabla I(x)\|}{\|\nabla I(y)\|} : x, y \in \mathbb{S}_{V,U}, V \in [0, V_0] \right\} < \infty.$$

Proof. Let

$$\mathcal{M} = \bigcup_{V>0} S_V.$$

Integrate the gradient vector field $x \mapsto \nabla I(x)$ on \mathcal{M} , and let α_x denote a compact arc along the integral curve through x , say parameterized on $[-1, 1]$ with $\alpha_x(0) = x$. Let $\beta = f^k(\alpha_x)$. Then

$$\|\nabla I(x)\|^2 = (I \circ \alpha_x)'(0) = (I \circ \beta)'(0) = C \nabla I(f^k(x)) \cdot \nabla I(f^k(x)),$$

where $C \nabla I(f^k(x))$ is the projection of $\beta'(0)$ onto $(T_{f^k(x)} S_V)^\perp$, $C > 0$ a constant. Hence

$$\|C \nabla I(f^k(x))\| = \frac{\|\nabla I(x)\|}{\|\nabla I(f^k(x))\|} \cdot \|\nabla I(x)\|.$$

□

Let D be as in Lemma 5.9 and μ and C as in Corollary 5.7. Let $k_0 \in \mathbb{N}$ be the smallest number such that $C\mu^{k_0} > D$. Fix $N \in \mathbb{N}$ with $N > k_0$. Let U^* be a neighborhood of $\{P_1, \dots, P_4\}$ in \mathbb{R}^3 such that $\overline{U^*} \subset U$, so small that if $x \in U^*$ and $l \in \mathbb{N}$ is the smallest number such that $f^l(x) \notin U$, then $l > N$.

Case (i). Suppose $x \in \mathbb{S}_{V,U}$, $f^k(x) \in \mathbb{S}_{V,U}$ and $N > k \geq k_0$. Then $C\mu^k > D$, hence the expansion in the cone $\mathcal{K}_V^u(x)$ dominates the expansion along the normal. On the other hand, the normal at x , under the action of Df_x^k , may tilt to the side away from $\mathcal{K}_V^u(f^k(x))$. However, since $k < N$, $\{x, f(x), \dots, f^k(x)\} \subset \mathbb{S}_{V,U^*}$. By compactness of S_{V,U^*} , the angle between the image under Df_x^k of the normal at x and \mathbb{S}_{V,U^*} remains uniformly bounded away from zero. This, together with the fact that $\mathcal{K}_V^u(x)$ is mapped into the interior of $\mathcal{K}_V^u(f^k(x))$, allows us to choose V_0 sufficiently small to compensate for the tilt in the normal. Hence for any $\eta > 0$, there exists $V_0 > 0$ small, such that $Df_x^k(K_V^\eta(x)) \subset K_V^\eta(f^k(x))$.

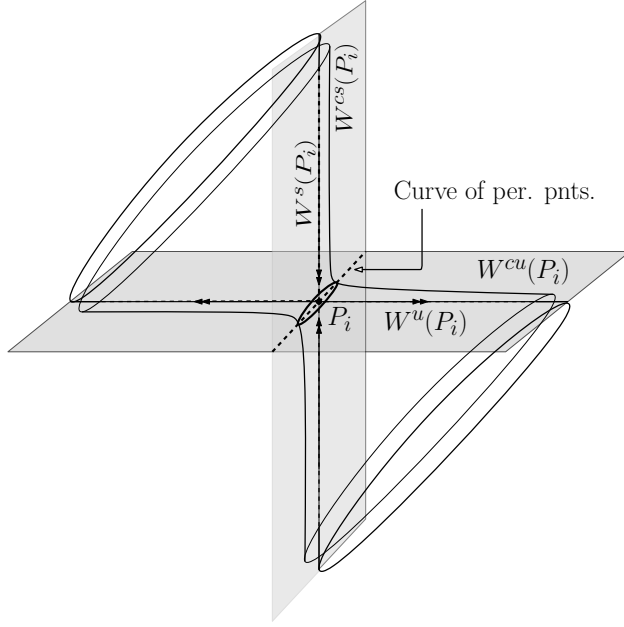

FIGURE 4.

Case (ii). If $x \in \mathbb{S}_{V,U}$, $f^k(x) \in \mathbb{F}_{j_0} \subset \mathbb{S}_{V,U}$ and $k < N$, then for sufficiently small η (depending only on N and independent of x), $K_V^\eta(x) \subset K_V^\eta(f^k(x))$; that is, given that the number of iterations does not exceed a given constant, the distortion can be controlled.

Case (iii). We now handle the case when x , under iterates of f , passes through U^* . By symmetries of the map f , it is enough to consider only a neighborhood of P_1 .

Say U^* is a neighborhood of P_1 . If U^* is sufficiently small, there exists a smooth change of coordinates $\Phi : U^* \rightarrow \mathbb{R}^3$ such that $\Phi(P_1) = (0, 0, 0)$ and the following holds.

Denote by $\mathbb{W}_1^{s,u}(P_1)$ a small neighborhood of the point P_1 on the manifold $\mathbb{W}_1^{s,u}$. We have

- $\Phi(\text{Per}_2(f))$ is part of the line $\{x = 0, z = 0\}$;
- $\Phi(\mathbb{W}_1^s(P_1))$ is part of the plane $\{z = 0\}$;
- $\Phi(\mathbb{W}_1^u(P_1))$ is part of the plane $\{x = 0\}$;
- $\Phi(\mathbb{W}_1^s \cap S_0)$ is part of the line $\{y = 0, z = 0\}$;
- $\Phi(\mathbb{W}_1^u \cap S_0)$ is part of the line $\{x = 0, y = 0\}$.

Denote $\mathfrak{S}_V = \Phi(S_V)$. Then $\{\mathfrak{S}_V\}_{V>0}$ is a family of smooth surfaces depending smoothly on V , \mathfrak{S}_0 is diffeomorphic to a cone, contains lines $\{y = 0, z = 0\}$ and $\{x = 0, y = 0\}$, and at each nonzero point on those lines it has a quadratic tangency with the xy - and zy -plane (see Figure 4).

For a point p , denote its coordinates by (x_p, y_p, z_p) .

Lemma 5.10 ([20, Propositions 3.12 and 3.13]). *Given $C_1, C_2 > 0$, $\rho > 1$, there exists $\delta_0 > 0$, $C > 0$, $\mu > 1$ and $N_0 \in \mathbb{N}$, such that for any $\delta \in (0, \delta_0)$, the following holds.*

Let $g : \mathbb{R}^3 \rightarrow \mathbb{R}^3$ be a C^2 diffeomorphism such that

- (i) $\|g\|_{C^2} \leq C_1$;
- (ii) The plane $\{z = 0\}$ is invariant under the iterates of g ;
- (iii) $\|Dg(p) - A\| < \delta$ for every $p \in \mathbb{R}^3$, where

$$A = \begin{pmatrix} \rho^{-1} & 0 & 0 \\ 0 & 1 & 0 \\ 0 & 0 & \rho \end{pmatrix}$$

is a constant matrix.

Introduce the following cone field on \mathbb{R}^3 :

$$(26) \quad \tilde{K}_p = \left\{ \mathbf{v} \in T_p \mathbb{R}^3, \mathbf{v} = \mathbf{v}_{xy} + \mathbf{v}_z : |\mathbf{v}_z| \geq C_2 \sqrt{|z_p|} \|\mathbf{v}_{xy}\| \right\}.$$

Then for any $p \in \mathbb{R}^3$ satisfying $|z_p| \leq 1$,

- (1) $Dg(\tilde{K}_p) \subset \tilde{K}_{g(p)}$;
- (2) if $|z_{g^N(p)}| > 1$ with $N \geq N_0$, then for any $\mathbf{v} \in \tilde{K}_p$, if $Dg^N(\mathbf{v}) = \mathbf{u}_{xy} + \mathbf{u}_z$, then

$$\|\mathbf{u}_{xy}\| < 2\delta^{1/2} |\mathbf{u}_z| \quad \text{and} \quad \|Dg^N(\mathbf{v})\| \geq C\mu^N \|\mathbf{v}\|.$$

For a given $\delta > 0$, if the neighborhood U^* of singularities is small enough, then at every point $p \in U^*$ the differential $D(\Phi \circ f \circ \Phi^{-1})(p)$ satisfies condition (iii) of Lemma 5.10. Since the tangency of \mathfrak{S}_0 with the plane $\{z = 0\}$ is quadratic, there exists $C_2 > 0$ such that every vector tangent to \mathfrak{S}_0 from the cone $D\Phi(\mathcal{K}^u)$ also belongs to the cone in (26). The same holds for vectors tangent to \mathfrak{S}_V from the cones $D\Phi(\mathcal{K}_V^v)$ for V small enough. Therefore, Lemma 5.10 can be applied to all those vectors. In particular, we have

Lemma 5.11. *Assume U is so small that Lemma 5.10 can be applied. There exists $C > 0$ such that if $x \in \mathbb{S}_{V,U}$, $f(x) \in U$ and $l \in \mathbb{N}$ is the smallest number such that $f^{l-1}(x) \in U$ and $f^l(x) \notin U$, then if $l > N_0$, then for any $\mathbf{v} \in T_x \mathbb{R}^3$ with $D\Phi(Df_x(\mathbf{v})) \in \tilde{K}_{\Phi(f(x))}$, we have*

- (1) $\mathbf{Proj}_{T_{f^l(x)} \mathbb{S}_{V,U}}(Df_x^l(\mathbf{v})) \in \mathcal{K}_V^v(f^l(x))$;
- (2) $\|Df_x^l(\mathbf{v})\| \geq C\mu^l \|\mathbf{v}\|$, where μ is as in Lemma 5.10.

Now, if U is sufficiently small and $V_0 > 0$ is sufficiently small, and $x \in \mathbb{S}_{V,U}$ with $f(x) \in U$, then for any $\eta > 0$ we have

$$D\Phi(Df_x(K_V^\eta(x))) \subset \tilde{K}_{\Phi(f(x))}.$$

Hence Lemma 5.11 can be applied to vectors in $Df(K_V^\eta(x))$. In particular, choosing U^* so small that $N > N_0$, we see that if $x \in \mathbb{S}_{V,U}$, $f(x) \in U$ and $k \in \mathbb{N}$ is the smallest number such that $f^k(x) \notin U$, and $\{x, f(x), \dots, f^{k-1}(x)\} \cap U^* \neq \emptyset$, then $Df_x^k(K_V^\eta(x)) \subset K_V^\eta(f^k(x))$, for any $\eta > 0$.

The proof of Lemma 5.8 follows by combining cases (i) and (ii), with

$$\eta = \hat{\eta} \min \left\{ \frac{C}{D}, 1 \right\},$$

where C is as in Corollary 5.7 and D is as in Lemma 5.9. \square

We immediately obtain, as a consequence of Lemma 5.8, the following

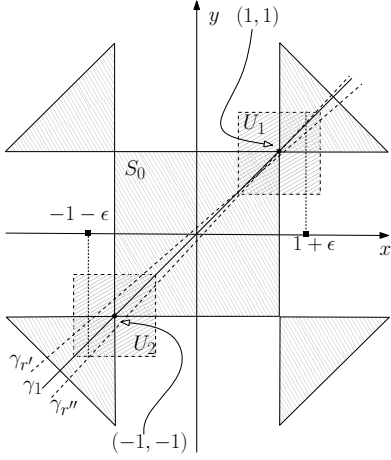

FIGURE 5.

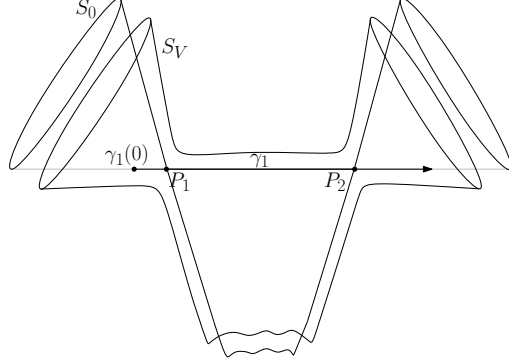

FIGURE 6.

Corollary 5.12. *Since the fundamental domain \mathbb{F}_{j_0} has quadratic tangency with S_0 , there exists $V_0 > 0$ and $\hat{\eta} > 0$ such that for all $V \in [0, V_0)$ and $x \in \mathbb{S}_{V,U} \cap \mathbb{F}_{j_0}$, the cone $K_V^{\hat{\eta}}(x)$ is transversal to \mathbb{F}_{j_0} . Let $\eta < \hat{\eta}$ be as in Lemma 5.8. Then for all $x \in \mathbb{S}_{V,U} \cap \mathbb{W}_{j_0}^s$ and $\mathbf{v} \in K_V^{\eta}(x)$, if x does not lie in the region bounded by α and the curve of periodic points (i.e. x lies in $\bigcup_{n \geq 0} f^{-n}(\mathbb{F}_{j_0})$), then \mathbf{v} is transversal to $\mathbb{W}_{j_0}^s$.*

Proof. For every $x \in \mathbb{S}_{V,U} \cap \mathbb{W}_{j_0}^s$ that satisfies the hypothesis of the corollary, there exists $k \in \mathbb{N}$, such that $f^k(x) \in \mathbb{F}_{j_0}$. The result follows by Lemma 5.8. \square

Now recall the definition of $\gamma_r(\lambda)$ from (22). With I denoting the Fricke-Vogt character (see (13)), we have

$$(27) \quad \begin{aligned} I(\gamma_r(\lambda)) &= \frac{\lambda}{4} \left(\frac{1}{r} - r \right)^2; \\ \frac{\partial I(\gamma_r(\lambda))}{\partial \lambda} &= \frac{1}{4} \left(\frac{1}{r} - r \right)^2. \end{aligned}$$

Consequently $\gamma_1(\lambda)$ is the line that contains the singularities P_1 and P_2 (see (15)) and lies entirely on S_0 . For $r \neq 1$, γ_r intersects the surfaces $\{S_V\}_{V \geq 0}$ transversely, intersecting each surface in a unique point, and intersects S_0 when $\lambda = 0$.

Case (i) (Assuming $J_1 \neq 1$). Assume $J_1 \neq 1$. If $\lambda = 0$ then by (2) of Proposition 4.1, $\mathcal{O}_f^+(\gamma_1(0))$ escapes. By continuity, there exists $r_0 \in (0, 1)$ such that for all $r \in (1 - r_0, 1 + r_0)$, the set

$$\left\{ x \in \gamma_r : \mathcal{O}_f^+(x) \text{ is bounded} \right\}$$

lies on a line segment Λ_r whose endpoints belong to U (the neighborhood of singularities) (see Figures 5 and 6). Let V_0 be so small that Corollary 5.12 can be applied, and $r_0 \in (0, 1)$ such that for all $r \in (1 - r_0, 1 + r_0)$, the line segment Λ_r lies entirely in $U \cup \left(\bigcup_{V \in [0, V_0)} \mathbb{S}_{V,U} \right)$. Let η and $\hat{\eta}$ be as in Corollary 5.12. If $\lambda > 0$

is such that $\gamma_r(\lambda) \in S_V$, from (27) we have

$$(28) \quad \frac{\partial I(\gamma_r(\lambda))}{\partial \lambda} = \frac{1}{\lambda} I(\gamma_r(\lambda)).$$

Since the set $\{\lambda : \gamma_r(\lambda) \in \Lambda_r, r \in (1 - r_0, 1 + r_0)\}$ is bounded away from zero uniformly in r , there exists $C_0 > 0$ such that for all such λ , if $\gamma_r(\lambda) \in S_{V,U}$, then

$$(29) \quad \angle(\gamma_r'(\lambda), S_V) \leq C_0 V.$$

On the other hand, $F^{-1}(\gamma_1 \cap \mathbb{S}) = \{\theta = -\phi\}$ (see (18)), and $(1, -1)$ is not an eigenvector of \mathcal{A} , hence by taking $K^u(p)$ in (23) wider as necessary, we have that for all λ such that $\gamma_r(\lambda) \in \mathbb{S} \setminus \{P_1, \dots, P_4\}$, $\gamma_r(\lambda) \in \text{Int}(\mathcal{K}^u)$. By continuity we have, for all r sufficiently close to 1 and V_0 close to 0, if λ is such that $\gamma_r(\lambda) \in S_{V,U}$, then

$$(30) \quad \mathbf{Proj}_{T_{\gamma_r(\lambda)} S_V}(\gamma_r) \in \mathcal{K}_V^u.$$

Combined with (29), this gives $\gamma_r(\lambda) \in K_V^\eta(\gamma_r(\lambda))$.

Now suppose λ is such that $\gamma_r(\lambda) \in \Lambda_r \cap U$. Let $k \in \mathbb{N}$ be the smallest number such that $f^k(\gamma_r(\lambda)) \in S_{V,U}$. If $k < N_0$, where N_0 is as in Lemma 5.10, then $\gamma_r(\lambda) \notin U^*$. The cones \mathcal{K}_V^u defined on $S_{V,U}$, $V \in [0, V_0)$, can be defined on S_{V,U^*} in the same way, by taking V_0 smaller as necessary. Hence by taking r_0 closer to 1 as necessary, for all $r \in (1 - r_0, 1 + r_0)$, if λ is such that $\gamma_r(\lambda) \in S_{V,U^*}$, then (30) again holds. Assuming V_0 was initially taken sufficiently small, we must have

$$Df_{\gamma_r(\lambda)}^k(\gamma_r'(\lambda)) \in K_V^\eta(f^k(\gamma_r(\lambda))).$$

Now suppose $k > N_0$.

Lemma 5.13. *For all sufficiently small C^1 -perturbations of γ_1 , $\Phi(\gamma_1)$ is tangent to the cones in (26) on $\Phi(U)$, with U a sufficiently small neighborhood of P_1 .*

Proof. Observe that γ_1 lies in the plane $\{z = 1\}$. Notice, from (19), that the curve of periodic points, $\text{Per}_2(f)$, is transversal to $\{z = 1\}$ at the point P_1 . A simple calculation shows that the eigenvector corresponding to the smallest eigenvalue of Df_{P_1} is also transversal to $\{z = 1\}$. Hence $\Phi(\gamma_1)$ is transversal to $\mathbb{W}_1^u(P_1)$ (a neighborhood of P_1 in \mathbb{W}_1^u), and so also to the plane $\{z = 0\}$ in the rectified coordinates. Hence all sufficiently small C^1 -perturbations of $\Phi(\gamma_1)$ are (uniformly) transversal to $\{z = 0\}$, and therefore tangent to the cones in (26) in $\Phi(U)$, for sufficiently small U . \square

Now Lemma 5.11 can be applied. We get

$$(31) \quad \mathbf{Proj}_{T_{f^k(\gamma_r(\lambda))} S_V} \left(Df_{\gamma_r(\lambda)}^k(\gamma_r'(\lambda)) \right) \in \mathcal{K}_V^u(f^k(\gamma_r(\lambda))).$$

On the other hand, by (29) we have

$$\left\| \mathbf{Proj}_{(T_{\gamma_r(\lambda)} S_V)^\perp}(\gamma_r'(\lambda)) \right\| \leq \frac{C_0 V}{\|\nabla I(\gamma_r(\lambda))\|},$$

and after applying (25) (Lemma 5.9) we obtain

$$(32) \quad \begin{aligned} & \left\| \mathbf{Proj}_{(T_{f^k(\gamma_r(\lambda))} S_V)^\perp} \left(Df_{\gamma_r(\lambda)}^k(\gamma_r'(\lambda)) \right) \right\| = \\ & = \frac{\|\nabla I(\gamma_r(\lambda))\|}{\|\nabla I(f^k(\gamma_r(\lambda)))\|} \left\| \mathbf{Proj}_{(T_{\gamma_r(\lambda)} S_V)^\perp}(\gamma_r'(\lambda)) \right\| \leq \frac{C_0}{\|\nabla I(f^k(\gamma_r(\lambda)))\|} V. \end{aligned}$$

By compactness, for all $V \in [0, V_0)$, $x \in \mathbb{S}_{V,U}$, $\|\nabla I(x)\|$ is uniformly bounded away from zero. Thus, assuming V_0 is sufficiently small, combining equations (31) and (32), we get

$$Df_{\gamma_r(\lambda)}^k(\gamma_r'(\lambda)) \in K_V^\eta(f^k(\gamma_r(\lambda))).$$

We can now use Corollary 5.12 to conclude that Λ_r intersects $\mathbb{W}_{j_0}^s$ transversely.

Case (ii) (Assuming $J_1 = 1$). When $J_1 = 1$, $\gamma_r(\lambda)$ has the form

$$(33) \quad \gamma_r(\lambda) = \left(\frac{\lambda - 2}{2}, \frac{\lambda - (1 + r^2)}{2r}, \frac{1 + r^2}{2r} \right).$$

Observe that if $r \neq 1$, then $\mathcal{O}_f^+(\gamma_r(0))$ escapes, since $f^2(\gamma_r(0))$ satisfies (2) of Proposition 4.1. Hence for all $r \neq 1$ (and sufficiently close to 1) there exists $\lambda_0(r) > 0$ such that for all $\lambda < \lambda_0(r)$, $\mathcal{O}_f^+(\gamma_r(\lambda))$ escapes, by Lemma 4.4. We have

Lemma 5.14. *There exists $C_0 > 0$ such that for all $r \neq 1$ sufficiently close to 1, and $\lambda_0(r)$ as above, if $\lambda \geq \lambda_0(r)$ and $\gamma_r(\lambda) \in S_V$, then*

$$\frac{V}{\lambda} \leq C_0 \sqrt{V}.$$

Proof. Let $\pi_1 : \mathbb{R}^3 \rightarrow \mathbb{R}$ denote projection onto the first coordinate. Since $r \approx 1$, $\lambda_0(r) \neq 0$ is close to zero, hence from (33),

$$|\pi_1(\gamma_r(\lambda_0))| < 1.$$

So by Proposition 4.1, $\mathcal{O}_f^+(\gamma_r(\lambda_0))$ will diverge if $|\pi_1 \circ f^i(\gamma_r(\lambda_0))| > 1$, $i = 1, 2$. A simple calculation shows the existence of a constant $D > 0$, independent of r , such that

$$|\pi_1 \circ f(\gamma_r(\lambda_0))| \leq 1 \text{ or } |\pi_1 \circ f^2(\gamma_r(\lambda_0))| \leq 1 \implies \lambda_0 \geq \frac{(r-1)^2}{D}.$$

Now, say $\gamma_r(\lambda) \in S_V$, and its forward orbit is bounded. Then $\lambda \geq \lambda_0(r)$. From (27),

$$V = \frac{\lambda}{4} \left(\frac{1}{r} - r \right)^2.$$

So

$$\frac{\sqrt{V}}{\lambda} = \frac{|r^2 - 1|}{2r\sqrt{\lambda}} \leq \frac{|r^2 - 1|}{2r\sqrt{\lambda_0}} \leq \frac{\sqrt{D}(r+1)}{2r}.$$

The right side above is uniformly bounded for all r away from zero. \square

Suppose $\gamma_r(\lambda) \in S_V$, $\gamma_r(\lambda) \in U^* \cap \Lambda_r$ and $k \in \mathbb{N}$ is the smallest number such that $f^k(\gamma_r(\lambda)) \in \mathbb{S}_{V,U}$. Then $\lambda \neq 0$ and $k > N_0$. From equation (28) and a calculation similar to (32), it follows that

$$(34) \quad \begin{aligned} & \left\| \mathbf{Proj}_{(T_{f^k(\gamma_r(\lambda))} S_V)^\perp} \left(Df_{\gamma_r(\lambda)}^k(\gamma_r'(\lambda)) \right) \right\| \\ &= \left\| \mathbf{Proj}_{(T_{f^k(\gamma_r(\lambda))} S_V)^\perp} \left(Df_{\gamma_r(\lambda)}^k \left(\mathbf{Proj}_{(T_{\gamma_r(\lambda)} S_V)^\perp}(\gamma_r'(\lambda)) \right) \right) \right\| \\ &\leq \frac{D_0}{\lambda} V \leq D_0 C_0 \sqrt{V}, \end{aligned}$$

where C_0 is as in Lemma 5.14 and

$$D_0 = \sup \left\{ \frac{1}{\|\nabla I(x)\|} : x \in \bigcup_{V \in [0, V_0)} \mathbb{S}_{V,U} \right\}.$$

On the other hand, $\|\gamma'_r(\lambda)\| > 1$ independently of r . Now by Lemma 5.13, Lemma 5.11 can be applied, so that by Part (2), with $C > 0$ and $\mu > 1$ as in the Lemma, we obtain

$$(35) \quad \left\| Df_{\gamma_r(\lambda)}^k(\gamma'_r(\lambda)) \right\| \geq C\mu^k \|\gamma'_r(\lambda)\| > C\mu^k.$$

Hence we have

- (1) $\mathbf{Proj}_{T_{f^k(\gamma_r(\lambda))} S_V} \left(Df_{\gamma_r(\lambda)}^k(\gamma'_r(\lambda)) \right) \in \mathcal{K}_V^u(f^k(\gamma_r(\lambda))),$
(2) and from (34) and (35),

$$\frac{\left\| \mathbf{Proj}_{(T_{f^k(\gamma_r(\lambda))} S_V)^\perp} \left(Df_{\gamma_r(\lambda)}^k(\gamma'_r(\lambda)) \right) \right\|}{\left\| Df_{\gamma_r(\lambda)}^k(\gamma'_r(\lambda)) \right\|} \leq \frac{D_0 C_0}{C\mu^k} \sqrt{V}.$$

Hence

$$\angle(Df_{\gamma_r(\lambda)}^k(\gamma'_r(\lambda)), S_V) \leq \tilde{\eta} \sqrt{V},$$

where $\tilde{\eta}$ can be made arbitrarily small if k is sufficiently large (i.e. if U^* is initially chosen sufficiently small). Hence

$$Df_{\gamma_r(\lambda)}^k(\gamma'_r(\lambda)) \in K_V^\eta,$$

and Corollary 5.12 can be applied.

Case (iii) (If a point doesn't enter \mathbb{F}_{j_0}). Assume that the point $\gamma_r(\lambda)$ lies on the region of $\mathbb{W}_{j_0}^s$ bounded by the curve of periodic points and the curve α (see discussion following Lemma 5.3). This is a finite region, hence contains at most finitely many points of intersection. So there exists $r_0 \in (0, 1)$, such that for all $r \in (1 - r_0, 1 + r_0)$, if γ_r intersects this region, then this intersection is transversal.

Combination of Cases (i), (ii) and (iii) gives transversality in Lemma 5.2. To prove uniform transversality, observe that by Lemma 5.8, the cones $\{K_V^\eta\}$ are transversal to $\{\mathbb{W}_i^s\}_{i \in \{1, \dots, 4\}}$ for $V > 0$ sufficiently small. It follows that the cones $\{K_V^{\eta/2}\}$ are uniformly transversal to $\{\mathbb{W}_i^s\}_{i \in \{1, \dots, 4\}}$ on surfaces away from S_0 . Hence by taking r closer to one as necessary, but not equal to one, we can ensure that γ_r lies in the cones $\{K_V^{\eta/2}\}$, and hence intersects $\{\mathbb{W}_i^s\}_{i \in \{1, \dots, 4\}}$ uniformly transversely. This finally concludes the proof of Lemma 5.2. \square

For justification of the following result, see [12, Section 2] and [11, Section 5.4].

Lemma 5.15. *For $V > 0$, $\{\mathbb{W}_i^s \cap S_V\}_{i \in \{1, \dots, 4\}}$ is dense (in the C^1 topology) in the lamination $W^s(\Omega_V)$.*

Now from our construction of the family \mathcal{W}^s in Proposition 4.10, together with Remark 4.11, combined with Lemma 5.15, we get that $\mathbb{W}_{i \in \{1, \dots, 4\}}^s$ is dense (in the C^1 topology) in the family \mathcal{W}^s from Proposition 4.10. Proposition 5.1 now follows from Lemma 5.2. \square

5.3. Proof of Theorem 2.1-(i). The proof of Theorem 2.1-(i) relies entirely on the dynamics of the trace map f , avoiding any spectral-theoretic considerations. We start with

Proposition 5.16. *With γ_r from (22), define*

$$\tilde{B}_{\infty,r} = \left\{ \lambda \in [0, \infty) : \mathcal{O}_f^+(\gamma_r(\lambda)) \text{ is bounded} \right\}.$$

Define also

$$\tilde{\sigma}_{k,r} = \left\{ \lambda \in [0, \infty) : |\pi \circ f^k(\gamma_r(\lambda))| \leq 1 \right\},$$

where π , as above, denotes projection onto the third coordinate. Then $\tilde{\sigma}_k \xrightarrow[k \rightarrow \infty]{} \tilde{B}_{\infty}$ in Hausdorff metric.

Proof. For convenience we drop r and simply write \tilde{B}_{∞} and $\tilde{\sigma}_k$, keeping in mind implicit dependence of these sets on r .

We begin the proof with the following simple observation.

Lemma 5.17. *For any $V > 0$, if $x = (x_1, x_2, x_3) \in \Omega_V$, then one of the coordinates of x is strictly smaller than one in absolute value.*

Proof. If all three coordinates are equal to one in absolute value, then x has -1 as one of its coordinates, and 1 for the other two (otherwise, x is one of the four singularities of S_0 , but by hypothesis $V > 0$). Then iterating forward twice gives a point that satisfies (2) of Proposition 4.1, hence x cannot be an element of Ω_V .

If at least one but not all of its coordinates is equal to one in absolute value, and the rest are strictly greater than one in absolute value, then by applying either f or $f^{-1} = (y, z, 2yz - x)$, we shall obtain a point (y_1, y_2, y_3) with $|y_1|, |y_2| > 1$ and $|y_1 y_2| > |y_3|$ or $|y_2|, |y_3| > 1$ and $|y_2 y_3| > |y_1|$. In the first case, by (2) of Proposition 4.1, the point (y_1, y_2, y_3) has unbounded forward semiorbit; in the second case, by a similar result applied to f^{-1} , (y_1, y_2, y_3) has unbounded backward semiorbit. In either case, x cannot belong to Ω_V . \square

By construction of the center-stable manifolds, it follows that \tilde{B}_{∞} is precisely the intersection of γ_r with the center-stable manifolds. As in the proof of Corollary 5.12, this intersection occurs on a compact line segment Λ_r along γ_r . Now application of Lemma 4.4 shows that \tilde{B}_{∞} is compact.

By Lemma 5.17 it follows that for all $\lambda \in \tilde{B}_{\infty}$, there exists $N_{\lambda} \in \mathbb{N}$, such that for all $k \geq N_{\lambda}$, $f^k(\gamma(\lambda))$ belongs to $\tilde{\sigma}_k \cup \tilde{\sigma}_{k+1} \cup \tilde{\sigma}_{k+2}$. By compactness of \tilde{B}_{∞} , there exists such $N \in \mathbb{N}$ uniformly for all $\lambda \in \tilde{B}_{\infty}$. Define

$$\Sigma_k = \tilde{\sigma}_{N+k} \cup \tilde{\sigma}_{N+k+1} \cup \tilde{\sigma}_{N+k+2}.$$

It is a simple observation that follows from Proposition 4.1 (see, for example, [15]) that $\Sigma_k \supset \Sigma_{k+1}$ for all $k \geq 0$, and $\tilde{B}_{\infty} = \bigcap_{k \geq 0} \Sigma_k$. It follows that $\Sigma_k \xrightarrow[k \rightarrow \infty]{} \tilde{B}_{\infty}$ in Hausdorff metric. It is therefore sufficient to prove that

$$(36) \quad \limsup_{k \rightarrow \infty} \mathbf{dist}_{\mathbb{H}}(\tilde{\sigma}_{N+k}, \Sigma_k) = 0.$$

Recall that $f|_{\mathbb{S}}$ is a factor of the toral automorphism $\mathcal{A} : \mathbb{T}^2 \rightarrow \mathbb{T}^2$ defined in (17), and the factor map F is given in (18). The Markov partition for \mathcal{A} on \mathbb{T}^2 is given in Figure 7 (see [12] and [18] for more details). This Markov partition is carried to a Markov partition on \mathbb{S} for f by the factor map F .

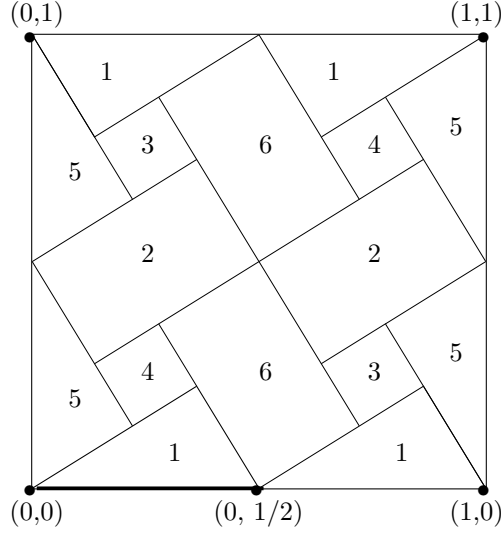

FIGURE 7. The Markov partition for $T|_{\mathbb{S}}$ (picture taken from [18]).

Let Λ_1 be the line segment along γ_1 that connects the singularities P_1 and P_2 . Then Λ_1 is precisely the set of those points on γ_1 whose forward orbit under iterations of $f|_{S_0}$ is bounded. The set $F^{-1}(\Lambda_1)$ is the line segment connecting $(0,0)$ and $(0, 1/2)$ in the Markov partition shown in Figure 7. This set is densely intersected by the stable manifold on \mathbb{T}^2 of the point $(0,0)$, and these intersections are carried by F to a dense subset of Λ_1 formed by intersections of Λ_1 with the strong-stable manifold on \mathbb{S} of the point P_1 .

Let ϑ be the curve of period-two periodic points for f , passing through P_1 , as defined in (19). Recall that \mathbb{W}_1^s denotes the stable manifold to ϑ . Since ϑ has two smooth branches connecting at P_1 , \mathbb{W}_1^s can be realized as two smooth manifolds, call them $\mathbb{W}_{1,j}^s$, $j = 1, 2$, that connect smoothly along the strong-stable manifold of P_1 on S_0 .

Lemma 5.18. *Let Λ_r be a compact line segment along γ_r which contains the intersection of γ_r with the center-stable manifolds. Assume also that the endpoints of Λ_r belong to this intersection. Then for all $r \approx 1$ but not equal to one, there exists a set $\{G_r^i\}_{i \in \mathbb{N}}$ of open, mutually disjoint subintervals of Λ_r (we call them gaps), such that $\tilde{B}_\infty \subset \Lambda_r \setminus \bigcup_i G_r^i$, and the collection of endpoints of all G_r^i is a dense subset of \tilde{B}_∞ . Moreover, for each i , one of the endpoints of G_r^i belongs to $\mathbb{W}_{1,1}^s$, and the other to $\mathbb{W}_{1,2}^s$.*

Proof. Let $r_0 \in (0, 1)$, such that for all $r \in (1 - r_0, 1 + r_0)$, $r \neq 1$, Λ_r intersects the center-stable manifolds transversely. Since $\Lambda_{r=1}$ intersects the strong-stable manifold of P_1 transversely (in a dense set of points), as soon as r is slightly perturbed, a gap opens with one endpoint in $\mathbb{W}_{1,1}^s$, the other in $\mathbb{W}_{1,2}^s$ (see Figure 8). This gap persists for all $r \in (1 - r_0, 1 + r_0)$ (i.e. as long as Λ_r intersects the center-stable manifolds transversely).

In order to show that the endpoints of these gaps form a dense subset of \tilde{B}_∞ , it is enough to show that no point inside of a gap belongs to \tilde{B}_∞ . This follows from,

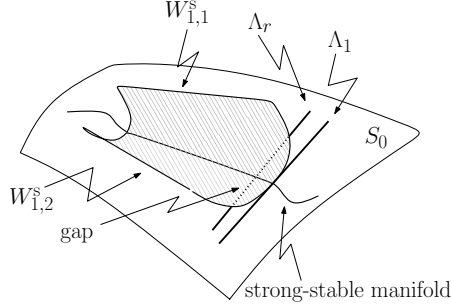

FIGURE 8.

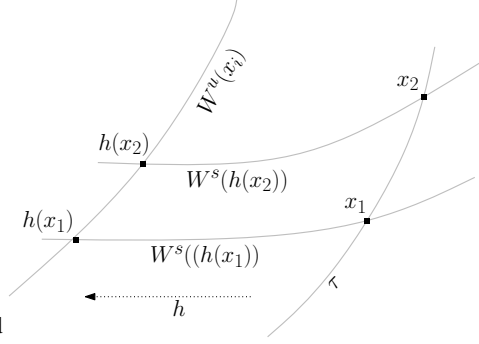

FIGURE 9.

for example, [11, Theorem 5.22] (in fact, the strong-stable and strong-unstable manifolds of the eight points that are born from the singularities $\{P_1, \dots, P_4\}$ form boundaries of the Markov partition on S_V , $V > 0$ —see also [12]). \square

Fix $\epsilon > 0$ and let C_1, \dots, C_m be an open cover of \tilde{B}_∞ , with $\mathbf{diam}(C_i) \leq \epsilon$, $i = 1, \dots, m$. It follows that for all k sufficiently large, Σ_k is entirely contained in $\bigcup_i C_i$.

Now, for any $j \in \{1, \dots, m\}$, pick a gap whose endpoints lie inside of C_j . Call one endpoint e_1 , and the other e_2 . Assume that e_1 lies on S_{V_1} , and e_2 on S_{V_2} (of course, $V_1, V_2 > 0$). Let $\vartheta \cap S_{V_1} = \{p_1, q_1\}$, and $\vartheta \cap S_{V_2} = \{p_2, q_2\}$ (here $f(p_i) = q_i$, $f(q_i) = p_i$). Say p_1 and p_2 lie on the same one of the two branches of ϑ , and $e_1 \in W^s(p_1)$. Then $e_2 \in W^s(q_2)$.

Observe that if $\mathbf{x} = (x, x/(2x-1), x) \in \vartheta$, then $f(\mathbf{x}) = (x/(2x-1), x, x/(2x-1))$. Hence if $\mathbf{x} \neq P_1$, either $|\pi(\mathbf{x})| < 1$ or $|\pi \circ f(\mathbf{x})| < 1$. It follows that $|\pi(p_i)| < 1$ or $|\pi(q_i)| < 1$. Since

$$|f^k(p_1) - f^k(e_1)| \xrightarrow[k \rightarrow \infty]{} 0 \quad \text{and} \quad |f^k(q_2) - f^k(e_2)| \xrightarrow[k \rightarrow \infty]{} 0,$$

and $|V_1 - V_2|$ is small provided that ϵ is sufficiently small (hence $|p_1 - p_2|$ and $|q_1 - q_2|$ are small), it follows that, for all k sufficiently large, either $|\pi \circ f^k(e_1)| < 1$ or $|\pi \circ f^k(e_2)| < 1$. Therefore, for all k sufficiently large, $\tilde{\sigma}_{N+k} \cap C_j \neq \emptyset$, proving (36). \square

Now define

$$\tilde{B}_\infty^- = \left\{ \lambda \in (-\infty, 0] : |\lambda| \in \tilde{B}_\infty \right\} \quad \text{and} \quad \tilde{\sigma}_k^- = \left\{ \lambda \in (-\infty, 0] : |\lambda| \in \tilde{\sigma}_k \right\}.$$

Take $B_\infty = \tilde{B}_\infty \cup \tilde{B}_\infty^-$. Then σ_k in (11) is precisely $\tilde{\sigma}_k \cup \tilde{\sigma}_k^-$, and so

$$\sigma_k \xrightarrow[k \rightarrow \infty]{} B_\infty \quad \text{in Hausdorff metric.}$$

This completes the proof of (i) of Theorem 2.1. In what follows, we prove properties of B_∞ stated in (ii)–(iv) of Theorem 2.1.

5.4. Proof of Theorem 2.1-(ii). This is a direct consequence of Propositions 4.12 and 5.1.

5.5. Proof of Theorem 2.1-(iii). Let M be a smooth two-dimensional Riemannian manifold and $\Lambda \subset M$ a basic set for $f \in \text{Diff}^2(M)$. Let $\{f_\alpha\} \subset \text{Diff}^2(M)$ depending continuously on $\alpha \in \mathbb{R}^+$, with $f = f_0$. Then there exists $\beta > 0$ such that for all $\alpha \leq \beta$, f_α has a basic set Λ_α near $\Lambda_0 = \Lambda$. Let $\{\tau_\alpha\}$, $\alpha \in \mathbb{R}^+$, be a family of smooth compact regular curves depending continuously on α in the C^1 -topology. Assume also that τ_0 intersects $W^s(\Lambda_0)$ transversely. Then there exists $\beta \in \mathbb{R}^+$, such that for all $\alpha \in [0, \beta)$, τ_α intersects $W^s(\Lambda_\alpha)$ transversely. Hence we may define the holonomy map

$$(37) \quad h_\alpha : \tau_\alpha \cap W^s(\Lambda_\alpha) \rightarrow \Lambda_\alpha$$

by sliding points along the stable manifolds to an unstable one (see Figure 9). Then locally h_α^{loc} and its inverse are well-defined, it is a homeomorphism onto its image, and, together with its inverse, is Lipschitz (Lipschitz continuity follows easily from Section B.1.4).

Proposition 5.19. *There exists $\beta > 0$ such that the Lipschitz constant for h_α^{loc} and its inverse can be chosen uniformly for all $\alpha \in [0, \beta)$.*

To prove Proposition 5.19, one proceeds by a (rather standard) technique that was first introduced in [1]. The proof is sketched in Appendix C.

Recall that a morphism of metric spaces $H : (M_1, d_1) \rightarrow (M_2, d_2)$ is said to be (C, ν) -Hölder continuous provided that for all $x, y \in M_1$, $d_2(H(x), H(y)) \leq Cd_1(x, y)^\nu$. We have the following, due to J. Palis and M. Viana [57, Theorem B].

Proposition 5.20. *Let $f : M \rightarrow M$ be a C^1 diffeomorphism on a Riemannian 2-manifold and $\Lambda \subset M$ a basic set for f with $(1, 1)$ splitting. Then there exists $C > 0$ and for any $\nu \in (0, 1)$ there exists $\mathcal{U} \subset \text{Diff}^1(M)$ an open neighborhood of f such that for all $g \in \mathcal{U}$ and $x \in \Lambda$, $H_g|_{W^u(x) \cap \Lambda}$ and its inverse are (C, ν) -Hölder continuous. Here $H_g : \Lambda \rightarrow \Lambda_g$ is the topological conjugacy (see Section B.1.1).*

Under the hypothesis of and with the notation from Proposition 5.19, we get

Lemma 5.21. *Let $\beta > 0$ satisfying Proposition 5.19. There exists $C > 0$ and for any $\nu \in (0, 1)$ there exists $\beta_0 \in (0, \beta)$, such that for any $\alpha_1, \alpha_2 \in [0, \beta_0)$, the map*

$$[h_{\alpha_2}^{\text{loc}}]^{-1} \circ H_{\alpha_1, \alpha_2} \circ h_{\alpha_1}^{\text{loc}} : \tau_{\alpha_1} \cap W^s(\Lambda_{\alpha_1}) \rightarrow \tau_{\alpha_2} \cap W^s(\Lambda_{\alpha_2}),$$

where $H_{\alpha_1, \alpha_2} : \Lambda_{\alpha_1} \rightarrow \Lambda_{\alpha_2}$ is the topological conjugacy, is (C, ν) -Hölder continuous (see Figure 10); that is, we have the following diagram, with $(h_{\alpha_i}^{\text{loc}})^{\pm 1}$ ($i = 1, 2$) Lipschitz, with the same Lipschitz constant, and H_{α_1, α_2} Hölder continuous.

$$\begin{array}{ccc} \tau_1 & \xrightarrow{h_{\alpha_1}} & W^u(y) \\ \downarrow h_{\alpha_2}^{-1} \circ H_{\alpha_1, \alpha_2} \circ h_{\alpha_1} & & \downarrow H_{\alpha_1, \alpha_2} \\ \tau_2 & \xleftarrow{h_{\alpha_2}^{-1}} & H_{\alpha_1, \alpha_2}(W^u(y)) \end{array}$$

where y is such that $W^u(y)$ is an unstable manifold at the point y containing the image of h_{α_1} .

Remark 5.22. We cannot expect any higher modulus of continuity than Hölder in general. Indeed, we cannot expect the Hausdorff dimension of the hyperbolic sets of a family of diffeomorphisms to be constant (which would be implied if

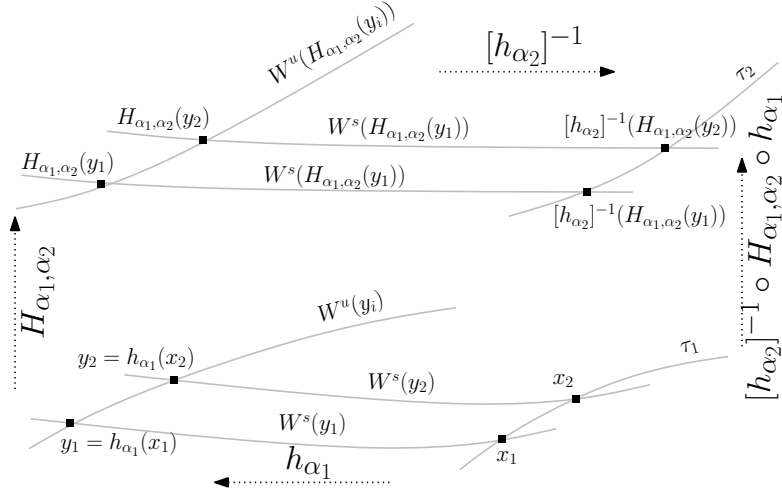

FIGURE 10.

above instead of Hölder continuity we had Lipschitz); very simple examples can be easily constructed. Yet more generally, holonomy maps along the so-called *center foliations* are quite bad: see J. Milnor's exposition of Katok's example of so-called *Fubini nightmare* in [54], as well as genericity results in [65].

Proof. Let $x_1 \in \tau_1 \cap W^s(\Lambda_{\alpha_1})$ and $h_{\alpha_1}^{\text{loc}}(x_1) \in W^u(y_1)$. Since the stable and unstable manifolds depend continuously on the point and on the diffeomorphism, if α_2 is sufficiently close to α_1 , then $\tau_{\alpha_2} \cap W^s(H_{\alpha_1, \alpha_2}(y_1)) \neq \emptyset$. Let $x_2 \in W^s(H_{\alpha_1, \alpha_2}(y_1)) \cap \tau_{\alpha_2}$ and $y_2 = H_{\alpha_1, \alpha_2}(y_1)$. Now $h_{\alpha_2}^{\text{loc}} : U \rightarrow W^u(y_2)$, where U is a neighborhood of x_2 in τ_{α_2} , is defined and Propositions 5.19 and 5.20 can be applied together. \square

Recall from (22):

$$\gamma_r(\lambda) = \left(\frac{\lambda - (1 + J_1^2)}{2J_1}, \frac{\lambda - (1 + r^2 J_1^2)}{2rJ_1}, \frac{1 + r^2}{2r} \right).$$

Hence γ_r lies in the plane

$$\Pi_r = \left\{ z = \frac{1 + r^2}{2r} \right\}.$$

Let $r_0 \in (0, 1)$ be as in Proposition 5.1. Let $r \in (1 - r_0, 1 + r_0)$, $r \neq 1$. Fix $x_0 \in \gamma_r$ whose forward orbit under f is bounded. Pick δ small, with $0 < \delta < V_0$, and let Γ be a compact segment along γ_r containing x_0 , with endpoints lying on $S_{V_0 - \delta}$ and $S_{V_0 + \delta}$ (note, x_0 may be an endpoint of Γ). Then Γ intersects the center-stable manifolds, as well as the surfaces S_V , $V \in [V_0 - \delta, V_0 + \delta]$, transversely. For $V \in [V_0 - \delta, V_0 + \delta]$, let τ_V denote the projection of Γ onto S_V along the plane Π_r . Then τ_V is a smooth, compact regular curve in S_V intersecting $W^s(\Omega_V)$ transversely (transversality with the center-stable manifolds follows from Proposition 5.1). Let

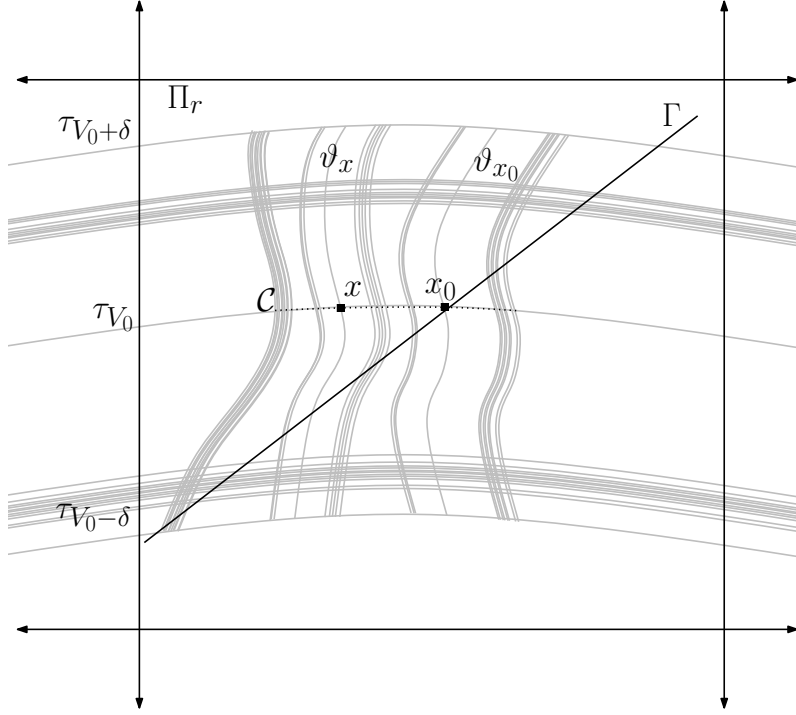

FIGURE 11.

$\mathcal{C} = \tau_{V_0} \cap W^s(\Omega_V)$. For every $x \in \mathcal{C}$, let

$$\vartheta_x = W^{cs}(x) \cap \Pi_r \cap \left(\bigcup_{V \in [V_0-\delta, V_0+\delta]} S_V \right),$$

where $W^{cs}(x)$ is the center-stable manifold containing x . Then (see Figure 11)

- C1. $\{\tau_V\}$ form a smooth foliation of Π ;
- C2. ϑ_x is a smooth compact regular curve with endpoints lying in $S_{V_0-\delta}$ and $S_{V_0+\delta}$;
- C3. $\{\vartheta_x\}_{x \in \mathcal{C}}$ intersects $\{\tau_V\}_{V \in [V_0-\delta, V_0+\delta]}$ and Γ uniformly transversely, and the curves ϑ_x depend continuously on x in the C^1 -topology (see Remark 4.11);
- C4. For $\delta > 0$ sufficiently small, $\{\tau_V\}_{V \in [V_0-\delta, V_0+\delta]}$ and $\{f_V\}_{V \in [V_0-\delta, V_0+\delta]}$ satisfy the hypothesis of Lemma 5.21. In particular, there exists $C > 0$ and for any $\nu \in (0, 1)$ there exists $0 < \epsilon < \delta$, such that the map $\mathcal{C} \ni x \mapsto \tau_V \cap W^s(\Omega_V)$ defined by projecting points along the curves $\{\vartheta_x\}_{x \in \mathcal{C}}$ is (C, ν) -Hölder continuous for all $V \in [V_0 - \epsilon, V_0 + \epsilon]$.

Now, from C1–C4 it follows that there exists a sufficiently small neighborhood U of x_0 in τ_{V_0} and $\tilde{C} > 0$, such that the map $U \cap \mathcal{C} \ni x \mapsto \Gamma$ defined by projecting points along the curves $\{\vartheta_x\}_{x \in U \cap \mathcal{C}}$ is (\tilde{C}, ν) -Hölder continuous (see [79, Lemma 3.5] for technical details). Hence

$$(38) \quad \mathbf{dim}_H^{\text{loc}}(\Gamma, x_0) = \mathbf{dim}_H^{\text{loc}}(\mathcal{C}, x_0).$$

On the other hand,

$$\mathbf{dim}_{\mathbb{H}}^{\text{loc}}(\mathcal{C}, x_0) = \mathbf{dim}_{\mathbb{H}}(W_{\text{loc}}^u(h(x_0))) = h^u(\Omega_{V_0}),$$

where $h : \mathcal{C} \rightarrow \Omega_{V_0}$ is a holonomy map as defined in (37), and h^u is defined in Section B.1.5 as the Hausdorff dimension of Ω_V along leaves of the unstable lamination $W^u(\Omega_V)$. Now, $h^u(\Omega_V)$ depends continuously (in fact analytically, as we shall see below) on V . It follows that the local Hausdorff dimension is continuous over B_∞ .

Proposition 5.23 ([11, Theorem 5.23]). *Let γ be an analytic curve in $\bigcup_{V>0} S_V$ parameterized on $(0, 1)$. Then $h^{s,u}(\Omega_{\gamma(t)}) : (0, 1) \rightarrow \mathbb{R}$ is analytic with values strictly between zero and one.*

Proposition 5.24 ([19, Theorem 1]). *The Hausdorff dimension of Ω_V is right-continuous at $V = 0$: $\lim_{V \rightarrow 0^+} h^u(\Omega_V) = 1$.*

Now, for $r \in (1 - r_0, 1 + r_0)$, let

$$\Gamma_r = \left\{ \lambda : \mathcal{O}_f^+(\gamma_r(\lambda)) \text{ is bounded} \right\}.$$

As we have already seen, Γ_r is a Cantor set; in particular it contains limit points. On the other hand, γ_r is an analytic curve that intersects S_V for every $V \in [0, \infty)$. Combining this with (38), Propositions 5.23 and 5.24, we get that the local Hausdorff dimension is non-constant over the spectrum.

Also, (38) in combination with Proposition 5.23 shows that the local Hausdorff dimension at every point of B_∞ is strictly between zero and one, hence so is the global Hausdorff dimension. It follows that the Lebesgue measure of B_∞ is zero.

5.6. Proof of Theorem 2.1-iv. Observe that the line $\gamma_{(J_0, J_1)}$ is continuous in the parameters (J_0, J_1) . From constructions carried out in the previous section, it is evident that $\mathbf{dim}_{\mathbb{H}}(B_\infty(J_0, J_1))$ is also continuous in the parameters (J_0, J_1) . Also, by Proposition 5.24, continuity extends to the pure case $J_0 = J_1$.

ACKNOWLEDGEMENT

I wish to express gratitude to my dissertation advisor, Anton Gorodetski, who originally introduced me to this problem and whose guidance and support have been essential for completion of this project.

I also wish to thank Michael Baake, Jean Bellissard, Alexander Chernyshev, David Damanik, Uwe Grimm, Svetlana Jitomirskaya, Ron Lifshitz and Laurent Raymond for meaningful and illuminating discussions.

A special thanks to Michael Baake, David Damanik and Anton Gorodetski for taking the time to read and comment on a draft.

Finally, I wish to thank the anonymous referees for their very helpful suggestions and remarks.

Appendices

None of what is presented in the following appendices is new. In particular, all of appendix B is by now part of the classical theory of hyperbolic and partially hyperbolic dynamical systems (and references are given to comprehensive surveys).

APPENDIX A. NORMAL HYPERBOLICITY OF SIX-CYCLES THROUGH
SINGULARITIES OF S_0 AND SYMMETRIES OF f

A.1. Normal hyperbolicity of six-cycles through singularities of S_0 . As has been mentioned above, S_0 contains four conic singularities; explicitly, they are

$$(39) \quad P_1 = (1, 1, 1), \quad P_2 = (-1, -1, 1), \quad P_3 = (1, -1, -1), \quad P_4 = (-1, 1, -1).$$

The point P_1 is fixed under f , while P_2, P_3 and P_4 form a three cycle:

$$P_1 \xrightarrow{f} P_1; \quad P_2 \xrightarrow{f} P_3 \xrightarrow{f} P_4 \xrightarrow{f} P_2$$

(which can be verified via direct computation).

For each $i \in \{1, \dots, 4\}$, there is a smooth curve ρ_i which does not contain any self-intersections, passing through the singularity P_i , such that $\rho_i \setminus P_i$ is a disjoint union of two smooth curves—call them ρ_i^l and ρ_i^r —with the following properties:

- $\rho_i^{l,r} \subset \bigcup_{V>0} S_V^{\mathbb{R}}$;
- $f(\rho_1^l) = \rho_1^r$ and $f(\rho_1^r) = f(\rho_1^l)$. In particular, points of $\rho_1^{l,r}$ are periodic of period two, and ρ_1 is fixed under f ;
- The six curves $\rho_i^{l,r}$, $i = 2, 3, 4$, form a six cycle under f . In particular, points of $\rho_i^{l,r}$, $i = 2, 3, 4$, are periodic of period six, and hence for $i = 2, 3, 4$, ρ_i is fixed under f^6 .

The curve ρ_1 is given explicitly by

$$(40) \quad \rho_1 = \left\{ \left(x, \frac{x}{2x-1}, x \right) : x \in (-\infty, 1/2) \cup (1/2, \infty) \right\}.$$

Expressions for the other three curves can be obtained from (40) using symmetries of f to be discussed below.

It follows via a simple computation that for any $i \in \{1, \dots, 4\}$ and any point $p \in \rho_i^{l,r}$, the eigenvalue spectrum of Df_p^6 is $\{1, \lambda(p), 1/\lambda(p)\}$ with $0 < |\lambda(p)| < 1$, where Df_p^6 denotes the differential of f^6 at the point p . The eigenspace corresponding to the eigenvalue 1 is tangent to ρ_i at p . At P_i , the eigenvalue spectrum of $Df_{P_i}^6$ is of the same form, and as above, the eigenspace corresponding to the unit eigenvalue is tangent to ρ_i at P_i . It follows that the curves $\{\rho_i\}_{i \in \{1, \dots, 4\}}$ are normally hyperbolic one-dimensional submanifolds of \mathbb{R}^3 , as defined in Section B.3.

For $V > 0$, $S_V^{\mathbb{R}} \cap (\rho_1 \cup \dots \cup \rho_4)$ consists of eight hyperbolic periodic points for f which are fixed hyperbolic points for f^6 . The stable manifolds to these points form a dense sublamination of the stable lamination

$$W^s(\Omega_V) = \bigcup_{x \in \Omega_V} W^s(x),$$

the union of global stable manifolds to points in Ω_V , the nonwandering set for f on S_V from Theorem 4.6. Moreover, this sublamination forms the boundary of the stable lamination. For details, see [11, 12, 18]. This extends to the center-stable lamination: the stable manifolds to the normally hyperbolic curves ρ_1, \dots, ρ_4 form a dense sublamination of the (two-dimensional) center-stable lamination and forms the boundary of this lamination. In particular, if γ is a smooth curve intersecting a center-stable manifold, and this intersection is not isolated, then in an arbitrarily small neighborhood of this intersection, γ intersects the stable manifolds of all eight curves: $\left\{ \rho_i^{l,r} \right\}_{i \in \{1, \dots, 4\}}$.

A.2. Symmetries of f . The following discussion is taken from [21]; however, what follows does not appear in [21] as new results but a recollection of what is known. In particular, the reader should consult [4, 63] and references therein, as well as earlier (and original) works [45–48].

Let us denote the group of symmetries of f^6 by \mathcal{G}_{sym} , and the group of reversing symmetries of f^6 by \mathcal{G}_{rev} ; that is,

$$(41) \quad \mathcal{G}_{\text{sym}} = \{s \in \text{Diff}(\mathbb{R}^3) : s \circ f^6 \circ s^{-1} = f^6\},$$

and

$$(42) \quad \mathcal{G}_{\text{rev}} = \{s \in \text{Diff}(\mathbb{R}^3) : s \circ f^6 \circ s^{-1} = f^{-6}\},$$

where $\text{Diff}(\mathbb{R}^3)$ denotes the set of diffeomorphisms on \mathbb{R}^3 .

Observe that $\mathcal{G}_{\text{rev}} \neq \emptyset$. Indeed,

$$(43) \quad s(x, y, z) = (z, y, x)$$

is a reversing symmetry of f , and hence also of f^6 . Hence f^6 is smoothly conjugate to f^{-6} . It follows (see Appendix A.1) that forward-time dynamical properties of f^6 , as well as the geometry of dynamical invariants (such as stable manifolds) are mapped smoothly and rigidly to those of f^{-6} . That is, forward-time dynamics of f^6 is essentially the same as its backward-time dynamics.

The group \mathcal{G}_{sym} is also nonempty, and more importantly, it contains the following diffeomorphisms:

$$(44) \quad \begin{aligned} s_2 &: (x, y, z) \mapsto (-x, -y, z), \\ s_3 &: (x, y, z) \mapsto (x, -y, -z), \\ s_4 &: (x, y, z) \mapsto (-x, y, -z). \end{aligned}$$

Notice that s_i are rigid transformations. Also notice that

$$s_i(P_1) = P_i,$$

and since s_i is in fact a smooth conjugacy, we must have

$$(45) \quad s_i(\rho_1) = \rho_i.$$

For a more general and extensive discussion of symmetries and reversing symmetries of trace maps, see [4].

APPENDIX B. BACKGROUND ON UNIFORM, PARTIAL AND NORMAL HYPERBOLICITY

B.1. Properties of locally maximal hyperbolic sets. A more detailed discussion can be found in [30, 31, 34–36].

A closed invariant set $\Lambda \subset M$ of a diffeomorphism $f : M \rightarrow M$ of a smooth manifold M is called *hyperbolic* if for each $x \in \Lambda$, there exists the splitting $T_x\Lambda = E_x^s \oplus E_x^u$ invariant under the differential Df , and Df exponentially contracts vectors in E_x^s and exponentially expands vectors in E_x^u . The set Λ is called *locally maximal* if there exists a neighborhood U of Λ such that

$$(46) \quad \Lambda = \bigcap_{n \in \mathbb{Z}} f^n(U).$$

The set Λ is called *transitive* if it contains a dense orbit. It isn't hard to prove that the splitting $E_x^s \oplus E_x^u$ depends continuously on $x \in \Lambda$, hence $\dim(E_x^{s,u})$ is locally constant. If Λ is transitive, then $\dim(E_x^{s,u})$ is constant on Λ . We call the splitting

$E_x^s \oplus E_x^u$ a (k_x^s, k_x^u) splitting if $\dim(E_x^{s,u}) = k^{s,u}$, respectively. In case Λ is transitive, we shall simply write (k^s, k^u) .

Definition B.1. We call $\Lambda \subset M$ a *basic set* for $f \in \text{Diff}^r(M)$, $r \geq 1$, if Λ is a locally maximal invariant transitive hyperbolic set for f .

Suppose Λ is a basic set for f with $(1, 1)$ splitting. Then the following holds.

B.1.1. *Stability.* Let U be as in (46). Then there exists $\mathcal{U} \subset \text{Diff}^1(M)$ open, containing f , such that for all $g \in \mathcal{U}$,

$$(47) \quad \Lambda_g = \bigcap_{n \in \mathbb{Z}} g^n(U)$$

is g -invariant transitive hyperbolic set; moreover, there exists a (unique) homeomorphism $H_g : \Lambda \rightarrow \Lambda_g$ such that

$$(48) \quad H_g \circ f|_{\Lambda} = g|_{\Lambda_g} \circ H_g;$$

that is, the following diagram commutes.

$$\begin{array}{ccc} \Lambda & \xrightarrow{f} & \Lambda \\ H_g \downarrow & & \downarrow H_g \\ \Lambda_g & \xrightarrow{g} & \Lambda_g \end{array}$$

Also H_g can be taken arbitrarily close to the identity by taking \mathcal{U} sufficiently small. In this case g is said to be *conjugate to f* , and H_g is said to be *the conjugacy*.

B.1.2. *Stable and unstable invariant manifolds.* Let $\epsilon > 0$ be small. For each $x \in \Lambda$ define the *local stable* and *local unstable* manifolds at x :

$$W_{\epsilon}^s(x) = \{y \in M : d(f^n(x), f^n(y)) \leq \epsilon \text{ for all } n \geq 0\},$$

$$W_{\epsilon}^u(x) = \{y \in M : d(f^n(x), f^n(y)) \leq \epsilon \text{ for all } n \leq 0\}.$$

We sometimes do not specify ϵ and write

$$W_{\text{loc}}^s(x) \quad \text{and} \quad W_{\text{loc}}^u(x)$$

for $W_{\epsilon}^s(x)$ and $W_{\epsilon}^u(x)$, respectively, for (unspecified) small enough $\epsilon > 0$. For all $x \in \Lambda$, $W_{\text{loc}}^{s,u}(x)$ is an embedded C^r disc with $T_x W_{\text{loc}}^{s,u}(x) = E_x^{s,u}$. The *global stable* and *global unstable* manifolds

$$(49) \quad W^s(x) = \bigcup_{n \in \mathbb{N}} f^{-n}(W_{\text{loc}}^s(x)) \quad \text{and} \quad W^u(x) = \bigcup_{n \in \mathbb{N}} f^n(W_{\text{loc}}^u(x))$$

are injectively immersed C^r submanifolds of M . Define also the stable and unstable sets of Λ :

$$(50) \quad W^s(\Lambda) = \bigcup_{x \in \Lambda} W^s(x) \quad \text{and} \quad W^u(\Lambda) = \bigcup_{x \in \Lambda} W^u(x).$$

If Λ is compact, there exists $\epsilon > 0$ such that for any $x, y \in \Lambda$, $W_{\epsilon}^s(x) \cap W_{\epsilon}^u(y)$ consists of at most one point, and there exists $\delta > 0$ such that whenever $d(x, y) < \delta$, $x, y \in \Lambda$, then $W_{\epsilon}^s(x) \cap W_{\epsilon}^u(y) \neq \emptyset$. If in addition Λ is locally maximal, then $W_{\epsilon}^s(x) \cap W_{\epsilon}^u(y) \in \Lambda$.

The stable and unstable manifolds $W_{\text{loc}}^{s,u}(x)$ depend continuously on x in the sense that there exists $\Phi^{s,u} : \Lambda \rightarrow \text{Emb}^r(\mathbb{R}, M)$ continuous, with $\Phi^{s,u}(x)$ a neighborhood of x along $W_{\text{loc}}^{s,u}(x)$, where $\text{Emb}^r(\mathbb{R}, M)$ is the set of C^r embeddings of \mathbb{R} into M [35, Theorem 3.2].

The manifolds also depend continuously on the diffeomorphism in the following sense. For all $g \in \text{Diff}^r(M)$ C^r close to f , define $\Phi_g^{s,u} : \Lambda_g \rightarrow \text{Emb}^r(\mathbb{R}, M)$ as we defined $\Phi^{s,u}$ above. Then define

$$\tilde{\Phi}_g^{s,u} : \Lambda \rightarrow \text{Emb}^r(\mathbb{R}, M)$$

by

$$\tilde{\Phi}_g^{s,u} = \Phi_g^{s,u} \circ H_g.$$

Then $\tilde{\Phi}_g^{s,u}$ depends continuously on g [35, Theorem 7.4].

B.1.3. Fundamental domains. Along every stable and unstable manifold, one can construct the so-called *fundamental domains* as follows. Let $W^s(x)$ be the stable manifold at x . Let $y \in W^s(x)$. We call the arc γ along $W^s(x)$ with endpoints y and $f^{-1}(y)$ a *fundamental domain*. The following holds.

- $f(\gamma) \cap W^s(x) = y$ and $f^{-1}(\gamma) \cap W^s(x) = f^{-1}(y)$, and for any $k \in \mathbb{Z}$, if $k < -1$, then $f^k(\gamma) \cap W^s(x) = \emptyset$; if $k > 1$ then $f^k(\gamma) \cap W^s(x) = \emptyset$ iff $x \neq y$;
- For any $z \in W^s(x)$, if for some $k \in \mathbb{N}$, $f^k(z)$ lies on the arc along $W^s(x)$ that connects x and y , then there exists $n \in \mathbb{N}$, $n \leq k$, such that $f^n(z) \in \gamma$.

Similar results hold for the unstable manifolds.

B.1.4. Invariant foliations. A stable foliation for Λ is a foliation \mathcal{F}^s of a neighborhood of Λ such that

- (1) for each $x \in \Lambda$, $\mathcal{F}(x)$, the leaf containing x , is tangent to E_x^s ;
- (2) for each x sufficiently close to Λ , $f(\mathcal{F}^s(x)) \subset \mathcal{F}^s(f(x))$.

An unstable foliation \mathcal{F}^u is defined similarly.

For a locally maximal hyperbolic set $\Lambda \subset M$ for $f \in \text{Diff}^1(M)$, $\dim(M) = 2$, stable and unstable C^0 foliations with C^1 leaves can be constructed; in case $f \in \text{Diff}^2(M)$, C^1 invariant foliations exist (see [56, Section A.1] and the references therein).

B.1.5. Local Hausdorff and box-counting dimensions. For $x \in \Lambda$ and $\epsilon > 0$, consider the set $W_\epsilon^{s,u} \cap \Lambda$. Its Hausdorff dimension is independent of $x \in \Lambda$ and $\epsilon > 0$.

Let

$$(51) \quad h^{s,u}(\Lambda) = \dim_H(W_\epsilon^{s,u}(x) \cap \Lambda).$$

For properly chosen $\epsilon > 0$, the sets $W_\epsilon^{s,u}(x) \cap \Lambda$ are dynamically defined Cantor sets, so

$$h^{s,u}(\Lambda) < 1$$

(see [56, Chapter 4]). Moreover, $h^{s,u}$ depends continuously on the diffeomorphism in the C^1 -topology [53]. In fact, when $\dim(M) = 2$, these are C^{r-1} functions of $f \in \text{Diff}^r(M)$, for $r \geq 2$ [52].

Denote the box-counting dimension of a set Γ by $\dim_{\text{Box}}(\Gamma)$. Then

$$\dim_H(W_\epsilon^{s,u}(x) \cap \Lambda) = \dim_{\text{Box}}(W_\epsilon^{s,u}(x) \cap \Lambda)$$

(see [53, 72]).

B.2. Partial hyperbolicity. For a more detailed discussion, see [32, 58].

An invariant set $\Lambda \subset M$ of a diffeomorphism $f \in \text{Diff}^r(M)$, $r \geq 1$, is called *partially hyperbolic (in the narrow sense)* if for each $x \in \Lambda$ there exists a splitting $T_x M = E_x^s \oplus E_x^c \oplus E_x^u$ invariant under Df , and Df exponentially contracts vectors in E_x^s , exponentially expands vectors in E_x^u , and Df may contract or expand vectors from E_x^c , but not as fast as in $E_x^{s,u}$. We call the splitting (k_x^s, k_x^c, k_x^u) splitting if $\dim(E_x^{s,c,u}) = k_x^{s,c,u}$, respectively. We shall write (k^s, k^c, k^u) if the dimension of subspaces does not depend on the point.

B.3. Normal hyperbolicity. For a more detailed discussion and proofs see [36] and also [58].

Let M be a smooth Riemannian manifold, compact, connected and without boundary. Let $f \in \text{Diff}^r(M)$, $r \geq 1$. Let N be a compact smooth submanifold of M , invariant under f . We call f *normally hyperbolic* on N if f is partially hyperbolic on N . That is, for each $x \in N$,

$$T_x M = E_x^s \oplus E_x^c \oplus E_x^u$$

with $E_x^c = T_x N$. Here $E_x^{s,c,u}$ is as in Section B.2. Hence for each $x \in N$ one can construct local stable and unstable manifolds $W_\epsilon^s(x)$ and $W_\epsilon^u(x)$, respectively, such that

- (1) $x \in W_{\text{loc}}^s(x) \cap W_{\text{loc}}^u(x)$;
- (2) $T_x W_{\text{loc}}^s(x) = E^s(x)$, $T_x W_{\text{loc}}^u(x) = E^u(x)$;
- (3) for $n \geq 0$,

$$d(f^n(x), f^n(y)) \xrightarrow[n \rightarrow \infty]{} 0 \text{ for all } y \in W_{\text{loc}}^s(x),$$

$$d(f^{-n}(x), f^{-n}(y)) \xrightarrow[n \rightarrow \infty]{} 0 \text{ for all } y \in W_{\text{loc}}^u(x).$$

(For the proof see [58, Theorem 4.3]). These can then be extended globally by

$$(52) \quad W^s(x) = \bigcup_{n \in \mathbb{N}} f^{-n}(W_{\text{loc}}^s(x));$$

$$(53) \quad W^u(x) = \bigcup_{n \in \mathbb{N}} f^n(W_{\text{loc}}^u(x)).$$

The manifold $W^s(x)$ is referred to as the *strong-stable manifold*, while $W^u(x)$ is called the *strong-unstable manifold*; sometimes to emphasize the point x , we add *at x* .

Set

$$(54) \quad W_{\text{loc}}^{\text{cs}}(N) = \bigcup_{x \in N} W_{\text{loc}}^s(x) \quad \text{and} \quad W_{\text{loc}}^{\text{cu}}(N) = \bigcup_{x \in N} W_{\text{loc}}^u(x).$$

Theorem B.2 (Hirsch, Pugh and Shub [36]). *The sets $W_{\text{loc}}^{\text{cs}}(N)$ and $W_{\text{loc}}^{\text{cu}}(N)$, restricted to a neighborhood of N , are smooth submanifolds of M . Moreover,*

- (1) $W_{\text{loc}}^{\text{cs}}(N)$ is f -invariant and $W_{\text{loc}}^{\text{cu}}$ is f^{-1} -invariant;
- (2) $N = W_{\text{loc}}^{\text{cs}}(N) \cap W_{\text{loc}}^{\text{cu}}(N)$;
- (3) For every $x \in N$, $T_x W_{\text{loc}}^{\text{cs,cu}}(N) = E_x^{s,u} \oplus T_x N$;
- (4) $W_{\text{loc}}^{\text{cs}}(N)$ ($W_{\text{loc}}^{\text{cu}}(N)$) is the only f -invariant (f^{-1} -invariant) set in a neighborhood of N ;

- (5) $W_{\text{loc}}^{\text{cs}}(N)$ (respectively, $W_{\text{loc}}^{\text{cu}}(N)$) consists precisely of those points $y \in M$ such that for all $n \geq 0$ (respectively, $n \leq 0$), $d(f^n(x), f^n(y)) < \epsilon$ for some $\epsilon > 0$.
- (6) $W_{\text{loc}}^{\text{cs,cu}}(N)$ is foliated by $\{W_{\text{loc}}^{\text{s,u}}(x)\}_{x \in N}$.

APPENDIX C. BACKGROUND RESULTS

We prove here some background results that follow from rather general principles in dynamical systems.

C.1. Proof of Proposition 5.19: sketch of main ideas. To prove Proposition 5.19, one proceeds by a (rather standard) technique that was first introduced in [1]. Let us sketch the proof below.

First suppose $\tau_\alpha = \tau_0 = \tau$ for all α . Let $x_0 \in \tau \cap W^s(\Lambda)$ and γ an open arc along τ containing x_0 such that h^{loc} and its inverse are defined along γ . Let U be an open neighborhood of Λ such that Λ is maximal in U , and U can be foliated into stable and unstable foliations. There exists $k_0 \in \mathbb{N}$ such that for all α , $f_\alpha^{k_0}(x_0) \in U$. Assuming γ is sufficiently short, we also have $f_\alpha^{k_0}(\gamma) \subset U$.

To simplify notation, let us write f for f_0 . Let $\gamma^s = f^{k_0}(\gamma)$ and let γ^u be the unstable manifold such that $f^{k_0} \circ h(x_0) \in \gamma^u$. Let $\tilde{h} : \gamma^s \rightarrow \gamma^u$ be the induced holonomy map:

$$\tilde{h}(x) = f^{k_0} \circ h^{\text{loc}} \circ f^{-k_0}.$$

By the C^1 stable foliation, \tilde{h} may be considered as the restriction of a C^1 map $F : \gamma^s \rightarrow \gamma^u$ to the set $f^{k_0}(\gamma \cap W^s(\Lambda))$. Then for all $x, y \in \gamma^s$ sufficiently close, there exists $k = k(x, y) \in \mathbb{N}$ such that the arc along $f^k(\gamma^s)$ (respectively, $f^k(\gamma^u)$) connecting the points $f^k(x), f^k(y)$ (respectively, $f^k(F(x)), f^k(F(y))$) belongs to U , and

$$(55) \quad \left[\frac{\mathbf{dist}_{f^k(\gamma^s)}(f^k(x), f^k(y))}{\mathbf{dist}_{f^k(\gamma^u)}(f^k(F(x)), f^k(F(y)))} \right]^{\pm 1} \leq 2,$$

where $\mathbf{dist}_\beta(a, b)$ denotes the distance between points a and b along the curve β (the number 2 is not significant; anything larger than 1 will work). Hence it is enough to provide an estimate, independent of k , for

$$(56) \quad \left[\frac{\mathbf{dist}_{\gamma^s}(x, y)}{\mathbf{dist}_{f^k(\gamma^s)}(f^k(x), f^k(y))} \right]^{\pm 1} \left[\frac{\mathbf{dist}_{f^k(\gamma^u)}(f^k(F(x)), f^k(F(y)))}{\mathbf{dist}_{\gamma^u}(F(x), F(y))} \right]^{\pm 1}.$$

In order to estimate (56), it is enough to estimate

$$\frac{\|Df^k|_{\gamma^s(x,y)}\|}{\|Df^k|_{\gamma^u(F(x),F(y))}\|},$$

where $\gamma^{s,u}(a, b)$ is the arc along $\gamma^{s,u}$ with endpoints a, b . After taking log, one estimates the latter by estimating

$$\sum_{j=0}^k \left| \|Df^j|_{\gamma^s(x,y)}\| - \|Df^j|_{\gamma^u(F(x),F(y))}\| \right|.$$

The sum above is majorized by a geometric series, and hence admits an upper bound L for all k . One shows that the bound in (55) and the bound L , for L

sufficiently large, hold for all f_α , $\alpha \in (0, \beta)$, with β sufficiently small (this follows from continuous dependence of f_α and Df_α on α).

Finally, small C^1 perturbations of τ do not destroy these bounds.

REFERENCES

- [1] D. V. Anosov and Ya. G. Sinai. Some Smooth Ergodic Systems. *Russian Mathematical Surveys*, 22:103–167, 1967.
- [2] J. Avron, v. Mouche, P. H. M., and B. Simon. On the measure of the spectrum for the almost Mathieu operator. *Commun. Math. Phys.*, 132:103–118, 1990.
- [3] M. Baake, U. Grimm, and D. Joseph. Trace maps, invariants, and some of their applications. *Int. J. Mod. Phys. B*, 7:1527–1550, 1993.
- [4] M. Baake and J. A. G. Roberts. Reversing symmetry group of $Gl(2, \mathbb{Z})$ and $PGL(2, \mathbb{Z})$ matrices with connections to cat maps and trace maps. *J. Phys. A: Math. Gen.*, 30:1549–1573, 1997. Printed in the UK.
- [5] J. Bellissard, B. Iochum, E. Scoppola, and D. Testard. Spectral properties of one dimensional quasi-crystals. *Commun. Math. Phys.*, 125:527–543, 1989.
- [6] V. G. Benza. Quantum Ising Quasi-Crystal. *Europhys. Lett. (EPL)*, 8:321–325, 1989.
- [7] V. G. Benza and V. Callegaro. Phase transitions on strange sets: the Ising quasicrystal. *J. Phys. A: Math. Gen.*, 23:L841–L846, 1990.
- [8] P. Bleher and M. Lyubich. The Julia sets and complex singularities in hierarchical Ising models. *Commun. Math. Phys.*, 141:453–474, 1992.
- [9] P. Bleher, M. Lyubich, and R. Roeder. Lee-Yang-Fisher zeros for DHL and 2D rational dynamics, I. Foliation of the physical cylinder. (*preprint*) *arXiv:1009.4691*.
- [10] P. Bleher, M. Lyubich, and R. Roeder. Lee-Yang-Fisher zeros for DHL and 2D rational dynamics, II. Global pluripotential interpretation. (*preprint*) *arXiv:1107.5764*.
- [11] S. Cantat. Bers and Hénon, Painlevé and Schrödinger. *Duke Math. J.*, 149:411–460, sep 2009.
- [12] M. Casdagli. Symbolic dynamics for the renormalization map of a quasiperiodic Schrödinger equation. *Commun. Math. Phys.*, 107:295–318, 1986.
- [13] H. A. Ceccatto. Quasiperiodic Ising model in a transverse field: Analytical results. *Phys. Rev. Lett.*, 62:203–205, 1989.
- [14] D. Damanik. Substitution Hamiltonians with Bounded Trace Map Orbits. *J. Math. Anal. App.*, 249:393–411, sep 2000.
- [15] D. Damanik. *Strictly ergodic subshifts and associated operators, Spectral theory and mathematical physics: a Festschrift in honor of Barry Simon's 60th birthday*. Sympos. Pure Math., 76, Part 2, Amer. Math. Soc., Providence, RI, 2007.
- [16] D. Damanik, M. Embree, and A. Gorodetski. Spectral properties of the Schrödinger operators arising in the study of quasicrystals. (*preprint*) *arXiv:1210.5753*.
- [17] D. Damanik, M. Embree, A. Gorodetski, and S. Tcheremchantsev. The fractal dimension of the spectrum of the Fibonacci Hamiltonian. *Commun. Math. Phys.*, 280:499–516, 2008.
- [18] D. Damanik and A. Gorodetski. Hyperbolicity of the trace map for the weakly coupled Fibonacci Hamiltonian. *Nonlinearity*, 22:123–143, 2009.
- [19] D. Damanik and A. Gorodetski. The spectrum of the weakly coupled Fibonacci Hamiltonian. *Electronic Research Announcements in Mathematical Sciences*, 16:23–29, may 2009.
- [20] D. Damanik and A. Gorodetski. Spectral and Dynamical Properties of the Weakly Coupled Fibonacci Hamiltonian. *Commun. Math. Phys.*, 305:221–277, 2011.
- [21] D. Damanik, P. Munger, and W. N. Yessen. Orthogonal polynomials on the unit circle with Fibonacci Verblunsky coefficients, I. The essential support of the measure. *To appear in J. Approx. Theory* (*arXiv:1208.0652*).
- [22] D. Damanik, P. Munger, and W. N. Yessen. Orthogonal polynomials on the unit circle with Fibonacci Verblunsky coefficients, II. Applications. (*in preparation*).
- [23] E. De Simone and L. Marin. Hyperbolicity of the trace map for a strongly coupled quasiperiodic Schrödinger operator. *Monatshefte für Mathematik*, 68:1–25, 2009.
- [24] M. M. Doria and I. I. Satija. Quasiperiodicity and long-range order in a magnetic system. *Phys. Rev. Lett.*, 60:444–447, 1988.
- [25] N. P. Fogg. Substitutions in dynamics, arithmetics and combinatorics. 1794, 2002. (V. Berthé, S. Ferenczi, C. Mauduit, A. Siegel, eds).

- [26] R. Fricke. Über die Theorie der automorphen Modulgrupper. *Nachr. Akad. Wiss. Göttingen*, pages 91–101, 1896.
- [27] R. Fricke and F. Klein. Vorlesungen der Automorphen Funktionen. *Teubner, Leipzig, Vol. I (1897) Vol. II (1912)*.
- [28] A. Gorodetski and W. N. Yessen. Newhouse phenomenon in the Fibonacci trace map. (*in preparation*).
- [29] U. Grimm and M. Baake. Aperiodic Ising models. *NATO Adv. Sci. Inst. Ser. C Math. Phys. Sci.*, 489:199–237, 1995. in *The mathematics of long-range aperiodic order* (Waterloo, ON, 1995) (Reviewer: J. Verbaarschot).
- [30] B. Hasselblatt. *Handbook of Dynamical Systems: Hyperbolic Dynamical Systems*, volume 1A. Elsevier B. V., Amsterdam, The Netherlands, 2002.
- [31] B. Hasselblatt and A. Katok. *Handbook of Dynamical Systems: Principal Structures*, volume 1A. Elsevier B. V., Amsterdam, The Netherlands, 2002.
- [32] B. Hasselblatt and Ya. Pesin. Partially hyperbolic dynamical systems. *Handbook of dynamical systems*, 1B:1–55, 2006. Elsevier B. V., Amsterdam (Reviewer: C. A. Morales).
- [33] J. Hermisson, U. Grimm, and M. Baake. Aperiodic Ising quantum chains. 30:7315–7335, 1997.
- [34] M. Hirsch, J. Palis, C. Pugh, and M. Shub. Neighborhoods of hyperbolic sets. *Invent. Math.*, 9:121–134, 1970.
- [35] M. W. Hirsch and C. C. Pugh. Stable Manifolds and Hyperbolic Sets. *Proc. Symp. Pure Math.*, 14:133–163, 1968.
- [36] M. W. Hirsch, C. C. Pugh, and M. Shub. Invariant Manifolds. *Lect. Notes Math. (Springer-Verlag)*, 583, 1977.
- [37] R. D. Horowitz. Characters of free groups represented in the two-dimensional special linear group. *Commun. Pure App. Math.*, 25:635–649, 1972.
- [38] S. Humphries and A. Manning. Curves of fixed points of trace maps. *Ergod. Th. Dynam. Sys.*, 27:1167–1198, 2007.
- [39] F. Iglói. Quantum Ising model on a quasiperiodic lattice. *J. Phys. A: Math. Gen.*, 21:L911–L915, 1988. Printed in the UK.
- [40] F. Iglói. Comparative study of the critical behavior in one-dimensional random and aperiodic environments. *Eur. Phys. J. B*, 5:613–625, 1998.
- [41] F. Iglói, R. Juhász, and Z. Zimborás. Entanglement entropy of aperiodic quantum spin chains. *EPL*, 79:37001–p1–37001–p6, 2007.
- [42] F. Iglói, L. Turban, D. Karevski, and F. Szalma. Exact renormalization-group study of aperiodic Ising quantum chains and directed walks. *Phys. Rev. B*, 56:11031–11050, 1997.
- [43] P. Jordan and E. Wigner. Über das Paulische Äquivalenzverbot. *Z. Phys.*, 47:631–651, 1928.
- [44] T. Jørgensen. Traces in 2-generator subgroups of $SL(2, \mathbb{C})$. In *Proc. Amer. Math. Soc.*, volume 84, pages 339–343, 1982.
- [45] L. P. Kadanoff. Analysis of Cycles for a Volume Preserving Map. (*unpublished manuscript*).
- [46] L. P. Kadanoff and C. Tang. Escape from strange repellers. *Proc. Nat. Acad. Sci. USA*, 81:1276–9, feb 1984.
- [47] M. Kohmoto. Dynamical system related to quasiperiodic Schrödinger equations in one dimension. *J. Stat. Phys.*, 66:791–796, 1992.
- [48] M. Kohmoto, L. P. Kadanoff, and C. Tang. Localization problem in one dimension: Mapping and escape. *Phys. Rev. Lett.*, 50:1870–1872, 1983.
- [49] D. Levine and P. J. Steinhardt. Quasicrystals: a new class of ordered structures. *Phys. Rev. Lett.*, 53:2477–2480, 1984.
- [50] D. Levine and P. J. Steinhardt. Quasicrystals. I. Definition and structure. *Phys. Rev. B*, 34:596–616, 1986.
- [51] E. Lieb, T. Schultz, and D. Mattis. Two soluble models of an antiferromagnetic chain. *Ann. Phys.*, 16:407–466, 1961.
- [52] R. Mañé. The Hausdorff dimension of horseshoes of diffeomorphisms of surfaces. *Boletim da Sociedade Brasileira de Matemática*, 20:1–24, may 1990.
- [53] A. Manning and M. McCluskey. Hausdorff Dimension for Horseshoes. *Ergod. Th. Dynam. Sys.*, 3:251–260, 1983.
- [54] J. Milnor. Fubini foiled: Katok’s paradoxical example in measure theory. *The Math. Intelligencer*, 19:30–32, 1997.
- [55] S. Ostlund, R. Pandit, D. Rand, H. J. Schellnhuber, and E. D. Siggia. One-dimensional Schrödinger equation with an almost periodic potential. *Phys. Rev. Lett.*, 50:1873–1876, 1983.

- [56] J. Palis and F. Takens. *Hyperbolicity and Sensitive Chaotic Dynamics at Homoclinic Bifurcations*. Cambridge University Press, Cambridge, 1993.
- [57] J. Palis and M. Viana. On the continuity of Hausdorff dimension and limit capacity for horseshoes. *Dynam. Sys. Valparaiso 1986*, pages 150–160, 1988.
- [58] Ya. Pesin. *Lectures on Partial Hyperbolicity and Stable Ergodicity*. Zurich Lect. Adv. Math., European Mathematical Society, 2004.
- [59] M. Queffélec. *Substitution dynamical systems – spectral analysis*, volume 1294 of *Lect. Notes in Math*. Springer, Springer-Verlag Berlin Heidelberg, 2nd edition, 2010. (J.-M. Morel, F. Takens, B. Teissier, eds).
- [60] L. Raymond. A constructive gap labelling for the discrete Schrödinger operator on a quasiperiodic chain. *preprint*, 1997.
- [61] J. A. G. Roberts. Escaping orbits in trace maps. *Physica A: Stat. Mech. App.*, 228:295–325, jun 1996.
- [62] J. A. G. Roberts and M. Baake. The Dynamics of Trace Maps. *Hamiltonian Mechanics: Integrability and Chaotic Behavior*, ed. J. Seimenis, NATO ASI Series B: Physics (Plenum Press, New York), pages 275–285, 1994.
- [63] J. A. G. Roberts and M. Baake. Trace maps as 3D reversible dynamical systems with an invariant. *J. Stat. Phys.*, 74:829–888, 1994.
- [64] D. Schechtman, I. Blech, J. W. Gratias, and D. Cahn. Mealy phase with long-range orientational order and no translational symmetry. *Phys. Rev. Lett.*, 53:1951–1953, 1984.
- [65] M. Shub and A. Wilkinson. Pathological foliations and removable zero exponents. *Invent. Math.*, 139:495–508, 2000.
- [66] B. Simon. Orthogonal polynomials on the unit circle. Part 1. Classical theory. *Amer. Math. Soc. Colloquium Publications*, 54, 2005.
- [67] B. Simon. Orthogonal polynomials on the unit circle. Part 2. Spectral theory. *Amer. Math. Soc. Colloquium Publications*, 54, 2005.
- [68] S. Smale. Differentiable Dynamical Systems. *Bull. Amer. Math. Soc.*, 73:747 – 817, 1967.
- [69] J. E. S. Socolar and P. J. Steinhardt. Quasicrystals. II. Unit-cell configurations. *Phys. Rev. B*, 34:617–647, 1986.
- [70] J. B. Southcott. Trace polynomials of words in special linear groups. *J. Australian Math. Soc. (Series A)*, 28:401–412, 1979.
- [71] A. Sütő. The spectrum of a quasiperiodic Schrödinger operator. *Commun. Math. Phys.*, 111:409–415, 1987.
- [72] F. Takens. *Limit capacity and Hausdorff dimension of dynamically defined Cantor sets*. Dynamical Systems. Lect. Notes Math. (Springer-Verlag), 1988.
- [73] M. Toda. Theory of Nonlinear Lattices. In *Solid-State Sciences 20*. Berlin-Heidelberg-New York, Springer-Verlag, 1981.
- [74] P. Tong. Critical dynamics of nonperiodic Ising chains. *Phys. Rev. E*, 56:1371–1378, 1997.
- [75] C. R. Traina. Trace polynomial for two generator subgroups of $SL(2, \mathbb{C})$. *Proc. Amer. Math. Soc.*, 79:369–372, 1980.
- [76] H. Tsunetsugu and K. Ueda. Ising spin system on the Fibonacci chain. *Phys. Rev. B*, 36:5493–5499, 1987.
- [77] L. Turban, F. Iglói, and B Berche. Surface magnetization and critical behavior of aperiodic Ising quantum chains. *Phys. Rev. B*, 49:12695–12702, 1994.
- [78] H. Vogt. Sur les invariants fondamentaux des equations différentielles linéaires du second ordre. *Ann. Sci. E. N. S. 3eme Série, Tome VI*, pages Supplement S.3–S.70, 1889.
- [79] W. N. Yessen. On the energy spectrum of 1D quantum Ising quasicrystal. *To appear in Annal. H. Poincaré (arXiv:1110.6894)*.
- [80] W. N. Yessen. Properties of 1D classical and quantum Ising quasicrystals: rigorous results. *Ann. Henri Poincaré (to appear, arXiv:1203.2221)*.
- [81] W. N. Yessen. Trace maps associated to substitution sequences and their applications. (*in preparation*).
- [82] W. N. Yessen. Spectral analysis of tridiagonal Fibonacci Hamiltonians. *J. Spectr. Theory*, 3:101–128, 2013.
- [83] J. Q. You and Q. B. Yang. Dynamical maps and Cantor-like spectra for a class of one-dimensional quasiperiodic lattices. *J. Phys.: Condens. Matter*, pages 2093–2098, 1990.
- [84] J. Q. You and Q. B. Yang. Quantum Ising models in transverse fields for a class of one-dimensional quasiperiodic lattices. *Phys. Rev. B*, 41:7073–7077, 1990.

E-mail address: `wyessen@math.uci.edu`

DEPARTMENT OF MATHEMATICS, UC IRVINE, IRVINE, CA 92697