

Mediation of Supersymmetry Breaking in Quivers

Roberto Auzzi, Amit Giveon and Sven Bjarke Gudnason

Racah Institute of Physics, The Hebrew University, Jerusalem 91904, Israel

E-mail: auzzi@phys.huji.ac.il, giveon@phys.huji.ac.il,
gudnason@phys.huji.ac.il

ABSTRACT: The soft masses due to SUSY breaking, mediated by gauge fields, are computed for generic matter in quiver gauge theories.

Contents

1	Introduction	1
2	Setting	2
3	The form factors	6
3.1	Masses of the quiver degrees of freedom	6
3.2	Computation of the form factors	7
4	Examples	9
4.1	Two nodes quiver	10
4.2	Three nodes quivers	12
4.2.1	The basic three nodes quiver – model q	12
4.2.2	Model p	14
4.2.3	The linear quiver $N = 3$	14
4.2.4	Model T	16
4.2.5	Bifundamental messenger models	16
4.3	More nodes	16
5	Discussion	20
A	Integrals	21
A.1	Example: MGM	25
A.2	Limits	25

1 Introduction

The mediation of supersymmetry (SUSY) breaking in quiver gauge theories has various interesting properties. First, attaching the SUSY-breaking sector and the matter superfields to different nodes of the quiver gives rise to a suppression of the sfermion masses, thus allowing a sufficiently light stop to explain the hierarchy problem, and produces exotic sparticle spectra with interesting collider signatures [1, 2]. This is especially important in the dynamical embedding of SUSY breaking and its mediation to the Minimal Supersymmetric extension of the Standard Model (MSSM) [3], where the gaugino masses vanish to leading order in SUSY breaking [4]. Moreover, separating the matter fields on different nodes gives rise to Yukawa-coupling textures which may deal with the flavor puzzle of the SM [5]. Quiver gauge theories also appear in four-dimensional low-energy realizations of models with large extra

dimensions [6] – viz. in gaugino mediated SUSY-breaking models [7, 8, 9, 10] – thus providing further motivation to investigate the mediation of SUSY breaking in quivers.

Recent studies of SUSY breaking and its mediation in the minimal case – a quiver with two nodes – already led to rather surprising results. First, one finds that both the right-handed and the left-handed sleptons can be lighter than the bino in the low-scale mediation regime [1, 2], even when the messenger scale is comparable to the masses of the additional gauge particles [11, 12]. Moreover, in this hybrid low-scale mediation case, the sfermion masses are comparable to those of the gauginos even when the latter vanish to leading order in SUSY breaking [13]. Finally, already this minimal setting provides intriguing ways to tackle the flavor puzzle as well as the $\mu/B\mu$ problem [5].

In this work, we compute the soft SUSY-breaking masses in a large class of models. Explicitly, in section 2, we set up our supersymmetric quivers, with matter and messengers in generic representations of the quiver’s product gauge groups, and present the general form of the soft masses. When all the MSSM matter fields are charged under the same node of the quiver, the theory is flavor blind. However, here we find the soft masses also for the generic case – when the matter fields are distributed on *different* nodes – in which case the flavor texture is rich.

The details of each model are encoded in a unique form factor, as we prove in section 3, where we also compute its value. In section 4, we analyze in more detail several examples of particular interest. Our emphasis is on models that may have perturbative unification, and we thus focus on quivers with at most five nodes. We inspect in more detail various examples of quivers with three nodes, which may incorporate the main freedom in flavor textures.

In the hybrid case – when the various scales in the problem are comparable – we find the following main property. The suppression of the scalar masses is significant when the matter superfields and messengers are not charged under the same node of the quiver, for any value of the messenger scale. This opens up phenomenologically appealing avenues, which we discuss in section 5. Finally, in the appendix we present some technical details.

2 Setting

In this note we consider mediation of SUSY breaking in a generic class of quiver gauge theories with N nodes connected by $K \geq N - 1$ bifundamental link fields and coupled to messenger fields in arbitrary representations, which are charged under at least one of the nodes; see fig. 1. Each node represents a gauge group G_i , $i = 1, \dots, N$, which we take, for simplicity, to be all the same group.¹ Each line linking two gauge groups represents a pair of bifundamental and anti-bifundamental chiral superfields (L_{ij}, \tilde{L}_{ij}) , whose vacuum expectation values (VEVs)

¹For phenomenological purposes one would be interested in the case where at low energies one of the groups is the SM one, say $G_1 = SU(3) \times SU(2) \times U(1)$. If one also imposes unification then the rest of the nodes need to be G_{GUT} -invariant, e.g. $G_i = SU(5)$ for $i > 1$. Perturbative unification further imposes an upper bound on the number of nodes. Our setting and formalism is generalized straightforwardly to such a case by summing over each of the SM subgroup factors in each node with their corresponding gauge couplings.

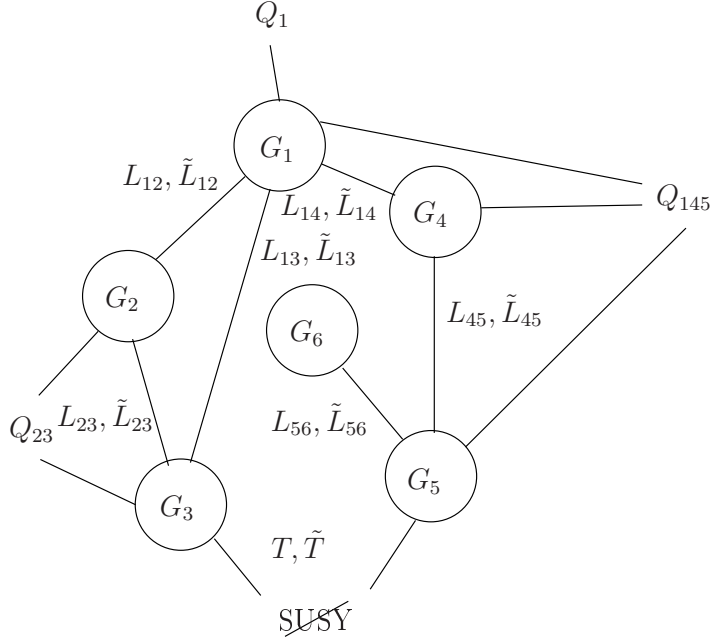

Figure 1. A random quiver representing a theory for which we compute the soft masses.

break the gauge symmetry to a linear combination of the various G_i 's. The superpotential of the link fields sector is given by

$$\mathcal{W}_L = \sum_{I=\{ij\}}^K H_{ij} \left(\text{Tr}(L_{ij}\tilde{L}_{ij}) - v_{ij}^2 \right) + \mathcal{W}_A, \quad (2.1)$$

where H_{ij} are singlet superfields and v_{ij} are the VEVs of the link fields ($\langle L_{ij} \rangle = \langle \tilde{L}_{ij} \rangle = v_{ij}\mathbf{1}$). Ideally, the VEVs are dynamically generated by some theory at higher energies, however, for simplicity, we shall impose them by hand (this does not change our analyzes in the following). The superpotential \mathcal{W}_A includes terms that give mass to the combinations of link fields which are not eaten by the gauge fields and which are not in the same $\mathcal{N} = 1$ multiplet as the massive vector boson. This can be achieved for instance with an adjoint field A_i of one of the groups G_i under which the set of link fields is charged [10],

$$\mathcal{W}_A = \sum_{I=\{ij\}}^K \text{Tr}(L_{ij}A_i\tilde{L}_{ij}). \quad (2.2)$$

The details of this mechanism are not important for the calculation of the soft masses.

We denote by A_μ^i the gauge field of the group G_i , and by g_i the corresponding gauge coupling. The unbroken combination \tilde{G} of the G_i 's, which in phenomenological applications

is identified with the Standard Model (SM) gauge group, is the following,

$$\tilde{A}_\mu = \frac{\sum_i^N \prod_{j \neq i}^N g_j A_\mu^i}{\sqrt{P_{N-1}(\{g_k^2\})}}, \quad (2.3)$$

where $P_{N-1}(\{x_i\}) \equiv \sum_i^N \prod_{j \neq i}^N x_j$ is the $(N-1)$ -th symmetric polynomial. Note that the linear combination (2.3) is independent of the VEVs. The gauge coupling of this unbroken combination is

$$\frac{1}{g_{\text{eff}}^2} = \sum_{i=1}^N \frac{1}{g_i^2}. \quad (2.4)$$

The scale of the VEVs is taken to be sufficiently larger than the electroweak scale, such that all the matter which gets a mass from the Higgsing of the link fields can be considered decoupled.

We denote the matter fields by $Q_{i_1 i_2 \dots i_{P_A}}^A$, which are chiral superfields transforming under the representation $(\mathbf{r}_{i_1}^A, \mathbf{r}_{i_2}^A, \dots, \mathbf{r}_{i_{P_A}}^A)$ of the gauge group $G_{i_1} \times G_{i_2} \times \dots \times G_{i_{P_A}}$, where A labels the matter fields and $P_A \leq N$ is the number of groups under which the field Q^A is charged. Each MSSM matter field is charged under one of the G_i 's; however, our formalism applies also to soft masses in more general settings with various exotic matter fields as well as to soft masses of the link fields.

We assume that SUSY is broken in some hidden sector and that the SUSY breaking is communicated to the visible sector by the gauge interactions of a subset of the groups G_i . In order to perform the following analysis in its full generality, it is convenient to use the global current multiplet formalism of [14, 15]. Let us consider a current $j_\mu^{t,m}$ charged under G_t , which is embedded in a real superfield $\mathcal{J}^{t,m}$ containing also a scalar $J^{t,m}$ component and a spinor $j_\alpha^{t,m}$, where $m = 1, \dots, \dim(G_t)$ is the adjoint index of G_t . The functions $C_r^t(x), B_{1/2}^t(x)$ parametrize the current correlators as follows

$$\begin{aligned} \langle J^{t,m}(x) J^{t,n}(0) \rangle &\equiv C_0^t(x) \delta^{mn}, \\ \langle j_\alpha^{t,m}(x) \bar{j}_\beta^{t,n}(0) \rangle &\equiv -i \sigma_{\alpha\dot{\beta}}^\mu \partial_\mu C_{1/2}^t(x) \delta^{mn}, \\ \langle j_\mu^{t,m}(x) j_\nu^{t,n}(0) \rangle &\equiv (\eta_{\mu\nu} \partial^2 - \partial_\mu \partial_\nu) C_1^t(x) \delta^{mn}, \\ \langle j_\alpha^{t,m}(x) j_\beta^{t,n}(0) \rangle &\equiv \frac{1}{4} \epsilon_{\alpha\beta} B_{1/2}^t(x) \delta^{mn}, \end{aligned} \quad (2.5)$$

where $\alpha, \beta, \dot{\beta} = 1, 2$ are spinor indices and the index t is referring to the group G_t . Now we can couple the SUSY-breaking current to R of the gauge groups $G_{t_1} \times G_{t_2} \times \dots \times G_{t_R}$. We denote by $\tilde{C}_r^t(p), \tilde{B}_{1/2}^t(p)$ the Fourier transforms of $C_r^t(x), B_{1/2}^t(x)$. The functions $\tilde{C}_1^t(p), \tilde{C}_{1/2}^t(p), \tilde{C}_0^t(p)$ parametrize the contribution to the sfermion masses mediated by gauge bosons (fig. 2a,b), gauginos (fig. 2c) and scalars (fig. 2d), respectively, viz. they represent the various blobs of the figure. Contributions to (the light) gaugino masses are instead parametrized by $\tilde{B}_{1/2}^t(p)$.

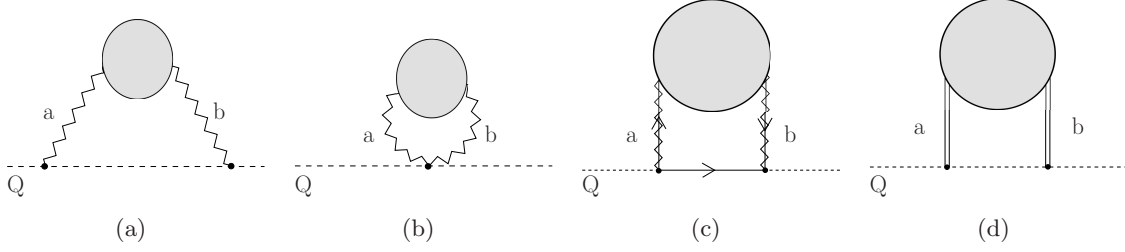

Figure 2. Contributions to the sfermion masses due to (a,b) gauge bosons, (c) gauginos and (d) D-terms.

If the theory contains a weakly coupled messenger sector, the components of the supercurrent $\mathcal{J}^{t,u,m}$, $u = 1, \dots, R$, are constructed in terms of the SUSY-breaking messengers fields T_B, \tilde{T}_B^\dagger , $B = 1, \dots, n_{\text{mess}}$, which transform under the representations $(\mathbf{s}_{t_1}, \mathbf{s}_{t_2}, \dots, \mathbf{s}_{t_R})$ of the gauge group $G_{t_1} \times G_{t_2} \times \dots \times G_{t_R}$, and $R \geq 1$ is the number of groups under which the messengers are charged. In this case, the components of $\mathcal{J}^{t,m}$ can be written explicitly

$$\begin{aligned}
J^{t,m} &= T_B^* t_t^m T_B - \tilde{T}_B^* t_t^m \tilde{T}_B, \\
j_\alpha^{t,m} &= -\sqrt{2}i \left(T_B^* t_t^m \psi_{T_B \alpha} - \tilde{T}_B^* t_t^m \psi_{\tilde{T}_B \alpha} \right), \\
j_\mu^{t,m} &= i \left(T_B t_t^m \partial_\mu T_B^* - T_B^* t_t^m \partial_\mu T_B - \tilde{T}_B t_t^m \partial_\mu \tilde{T}_B^* + \tilde{T}_B^* t_t^m \partial_\mu \tilde{T}_B \right) \\
&\quad + \psi_{T_B} \sigma_\mu t_t^m \bar{\psi}_{T_B} - \psi_{\tilde{T}_B} \sigma_\mu t_t^m \bar{\psi}_{\tilde{T}_B},
\end{aligned} \tag{2.6}$$

where t_t^m are the generators of G_t .

In the explicit examples in section 4, for simplicity, we will focus on a minimal sector with just a single messenger coupled to an F-term spurion of SUSY breaking, S , via the superpotential $\mathcal{W}_T = \lambda_S S T \tilde{T}$. Explicit expressions for the functions $\tilde{C}_r^t(p), \tilde{B}_{1/2}^t(p)$ in the case of a general weakly coupled messenger sector, coupled both to an F-term and a D-term spurion, can be found in [16] and in Appendix B.5 of [17].

The gauginos of the unbroken gauge group \tilde{G} acquire a SUSY-breaking soft mass at one loop, which can be computed as in gauge mediation [14],

$$M_{\tilde{g}} = \frac{g_{\text{eff}}^2}{4} \sum_{u=1}^R \tilde{B}_{1/2}^{t_u}(p^2 = 0). \tag{2.7}$$

If additional matter fields in the adjoint representation are present, the gauginos can also acquire Dirac masses (see e.g. [18, 19] for a recent discussion).

The purpose of this note is to find the value for the scalar soft masses of the matter field $Q_{i_1 i_2 \dots i_{P_A}}^A$; the result is

$$m_{i_1 i_2 \dots i_{P_A}}^2 = -g_{\text{eff}}^4 \sum_{j=1}^{P_A} \sum_{u=1}^R c_2(\mathbf{r}_{i_j}^A) \int \frac{d^4 p}{(2\pi)^4} \frac{1}{p^2} f_{i_j}^{t_u}(p^2) \left[3\tilde{C}_1^{t_u}(p) - 4\tilde{C}_{1/2}^{t_u}(p) + \tilde{C}_0^{t_u}(p) \right], \tag{2.8}$$

where $c_2(\mathbf{r}_{i_j}^A)$ is the quadratic Casimir of the representation under which the field $Q_{i_1 i_2 \dots i_{P_A}}^A$ transforms with respect to the group G_{i_j} and the sum is over all the groups under which the field is charged. The form factor $f_{i_j}^{t_u}(p^2)$ depends on the quiver structure and the various parameters such as the gauge couplings and the VEVs of the link fields, etc. G_{i_j} is one of the groups under which the matter is charged and G_{t_u} is one of the groups under which the messengers are charged. For $N = 1$, i.e. the single node case, General Gauge Mediation (GGM) is recovered [14]² and $f_{\text{GGM}} = f_1^1 = 1$. In the next section, we derive eq. (2.8) and find the explicit expression for the form factors $f_{i_j}^{t_u}(p^2)$.

Finally, the soft masses for the link fields, which are bifundamental fields, are obtained from the same formula, (2.8), by summing over just two groups (corresponding to $P_A = 2$ and $i_1 = i, i_2 = j$ for a link field L_{ij}).

3 The form factors

3.1 Masses of the quiver degrees of freedom

As a prelude, we discuss the masses in the quiver theory. We parametrize the K link fields using an index $I = 1, \dots, K$; the link fields are denoted by $L_I(\tilde{L}_I)$, where each I corresponds to a particular set of values (i, j) , i.e., the fields transform as $(\square, \bar{\square})$ ($(\bar{\square}, \square)$) under the group $G_i \times G_j$. For simplicity, we assume that all the link field VEVs v_I are real (in many cases this can be achieved by a gauge transformation; cases where this cannot be achieved for all the VEVs would lead to potentially dangerous CP violations). We define the following $N \times K$ matrix

$$Z_{\ell I} \equiv \sqrt{2} g_\ell v_I (\delta_{\ell i} - \delta_{\ell j}) , \quad (3.1)$$

in terms of which the mass-squared matrix of the vector gauge bosons is given by

$$\mathcal{M}_V^2 = Z Z^T , \quad (3.2)$$

which is an $N \times N$ mass-squared matrix with $N - 1$ non-vanishing eigenvalues and one zero eigenvalue (the SM gauge bosons). Diagonalization of the matrix is done by a unitary transformation,

$$U \mathcal{M}_V^2 U^\dagger = \mathcal{D}_V^2 = \text{diag} (m_1^2, m_2^2, m_3^2, \dots, m_N^2) , \quad (3.3)$$

where \mathcal{D}_V^2 is a diagonal matrix with eigenvalues $m_1^2 \leq m_2^2 \leq m_3^2 \leq \dots \leq m_{N-1}^2$, and $m_N = 0$.

Only particular combinations of the link fields will participate actively in the mediation of SUSY breaking; these degrees of freedom are in the same $\mathcal{N} = 1$ multiplets as the massive gauge bosons and are given by

$$l_I \equiv \frac{1}{\sqrt{2}} \text{Re} (\delta L_I - \delta \tilde{L}_I) , \quad (3.4)$$

²In this case, in the limit of vanishing effective gauge coupling, $g_{\text{eff}} \rightarrow 0$, the SM matter decouples from the SUSY-breaking sector, and thus the theory belongs to the GGM class, as defined in [14]. On the other hand, in the case of several nodes, the quiver theory does not necessarily obey this criterion.

where $L_I = v_I + \delta L_I$, and analogously for \tilde{L}_I . The mass-squared matrix of these fields is

$$\mathcal{M}_S^2 = Z^T Z . \quad (3.5)$$

Suppose now that v is an eigenvector of the matrix ZZ^T with eigenvalue λ , $ZZ^T v = \lambda v$, then $Z^T v$ is an eigenvector of $Z^T Z$ with the same eigenvalue λ . Hence, for all eigenvectors of the mass-squared matrix for the vector multiplet \mathcal{M}_V^2 with non-vanishing eigenvalue $\lambda \neq 0$, there exist the same mass-squared for the scalars (as SUSY dictates). Due to the fact that there are at most $N - 1$ non-vanishing eigenvalues of both mass-squared matrices, we can diagonalize the $K \times K$ mass-squared matrix \mathcal{M}_S^2 as follows

$$W \mathcal{M}_S^2 W^\dagger = \mathcal{D}_V^2 , \quad (3.6)$$

where W is an $N \times K$ matrix.

The gauginos λ_i are mixed with some linear combinations of the link fields by the following Dirac mass term,

$$Z_{\ell I} \lambda_\ell \psi_{\ell I} + \text{h.c.} , \quad (3.7)$$

where $\psi_{\ell I} = \frac{1}{\sqrt{2}}(\psi_{L_I} - \psi_{\tilde{L}_I})$. These mass terms can be diagonalized as follows,

$$U Z W^\dagger = \mathcal{D}_V , \quad (3.8)$$

which is formally given by $(\mathcal{D}_V^2)^{1/2}$.

3.2 Computation of the form factors

It is sufficient to compute the mass of a sfermion Q_i charged under a single group G_i , in presence of a SUSY-breaking sector charged just under the group G_i . The more general expression in eq. (2.8) follows by linearity. There are three classes of diagrams to calculate, i.e. the diagrams involving gauge bosons, gauginos and scalars; see figure 2. Now we will show that all three classes of diagrams give rise to the same form factor $f_i^t(p^2)$.

First, let us consider the diagrams involving gauge bosons; see fig. 2a,b. The coupling of the vector bosons to the SUSY-breaking sector is

$$- g_t j_\mu^{t,m} A_t^{\mu m} , \quad (3.9)$$

where $j_\mu^{t,m}$ is the vectorial component of the current multiplet presented near eq. (2.5). The matter field Q_i , on the other hand, couples just to the gauge boson A_μ^i . Both the gauge bosons (A_μ^t, A_μ^i) are not mass eigenstates, in general; the propagators of these fields should be decomposed into a linear combination of the N mass eigenstates. Then the factor g_{eff}^2/p^2 in the gauge mediation integrand should be replaced by

$$g_i g_t \sum_{a=1}^N U_{ia}^\dagger \frac{1}{p^2 - m_a^2} U_{at} , \quad (3.10)$$

where the matrix U is the unitary matrix in eq. (3.3) rotating to the mass eigenstates of the gauge bosons in which the propagators are written. The factor of eq. (3.10) is independent of the blob of fig. 2a,b and hence the form factor reads

$$f_i^t(p^2) = \left(\frac{g_i g_t}{g_{\text{eff}}^2} \sum_{a=1}^N U_{ia}^\dagger \frac{p^2}{p^2 - m_a^2} U_{at} \right)^2, \quad (3.11)$$

where both gauge boson a and b in the figure contribute with the same factor and hence the result is a perfect square.

Now we turn to the diagram with the gauginos; see fig. 2c. The coupling of the gauginos to the sfermions reads

$$g_i (Q_i t_i^m \bar{\psi}_{Q_i} \bar{\lambda}_i^m - Q_i^* t_i^m \psi_{Q_i} \lambda_i^m), \quad (3.12)$$

where t_i^m are generators of the group G_i . The coupling of gauginos to the SUSY-breaking sector, on the other hand, is given by

$$-g_t (j^{t,m} \lambda_t^m + \bar{j}^{t,m} \bar{\lambda}_t^m), \quad (3.13)$$

where the spinor indices have been contracted and $j_\alpha^{t,m}$ is the spinorial component of the current multiplet presented near eq. (2.5). Again we should decompose the propagators into mass eigenstates; the gauge mediation factor, $i g_{\text{eff}}^2 p \cdot \sigma_{\alpha\dot{\beta}} / p^2$ in the integrand, is then replaced by

$$i g_i g_t \sum_{a=1}^N U_{ia}^\dagger \frac{p \cdot \sigma_{\alpha\dot{\beta}}}{p^2 - m_a^2} U_{at}, \quad (3.14)$$

which again gives rise to the same form factor (3.11).

Finally, we need to consider scalar-mediated diagrams; see fig. 2d. The D-terms give rise to the trilinear couplings between the link field scalars l_I and the sfermions

$$g_i Z_{iI} l_I^m (Q_i^* t_i^m Q_i), \quad (3.15)$$

while the SUSY-breaking sector similarly has the trilinear couplings,

$$g_t Z_{tI} l_I^m J^{t,m}, \quad (3.16)$$

where $J^{t,m}$ is the scalar component of the current multiplet presented near eq. (2.5). The D-terms provide also a direct coupling between the sfermions and the SUSY-breaking sector,

$$g_i^2 \delta_{it} (Q_i^* t_i^m Q_i) J^{t,m}. \quad (3.17)$$

The contribution due to the exchange of a scalar l_I (which is due to the vertices in eqs. (3.15), (3.16)) should then again be decomposed in terms of mass eigenstate propagators,

$$\begin{aligned} g_i g_t \sum_{a=1}^N \sum_{I,J=1}^K Z_{iI} W_{Ia}^\dagger \frac{1}{p^2 - m_a^2} W_{aJ} Z_{Jt}^\dagger &= g_i g_t U_{ij}^\dagger U_{jk} Z_{kI} W_{Ia}^\dagger \frac{1}{p^2 - m_a^2} W_{aJ} Z_{Jt}^\dagger U_{lm}^\dagger U_{mt} \\ &= g_i g_t \sum_{a=1}^N U_{ia}^\dagger \frac{m_a^2}{p^2 - m_a^2} U_{at}, \end{aligned} \quad (3.18)$$

where we have used that $UZW^\dagger = \mathcal{D}_V = (\mathcal{D}_V^2)^{1/2}$ is the diagonal $N \times N$ mass matrix. In the case that $i = t$ we still have the contribution from the vertex in eq. (3.17), hence, writing down the total form factor we obtain

$$f_i^t(p^2) = \left(\frac{g_i g_t}{g_{\text{eff}}^2} \sum_{a=1}^N \left(U_{ia}^\dagger \frac{m_a^2}{p^2 - m_a^2} U_{at} + \delta_{it} \right) \right)^2, \quad (3.19)$$

which is exactly that of eq. (3.11). This establishes the proof of eq. (2.8) and provides the explicit value of the form factor $f_i^t(p^2)$.

4 Examples

In this section we shall focus on a minimal messenger sector, with just a single messenger pair coupled to an F-term spurion S via the superpotential

$$\mathcal{W}_T = ST\tilde{T}, \quad \langle S \rangle = M + \theta^2 F. \quad (4.1)$$

In this case the current correlators are given by eqs. (A.2)-(A.4) in the appendix.

Once $f_{ij}^{tu}(p^2)$ are given, the integrals can be directly evaluated given the SUSY-breaking contributions parametrized by the current correlators $\tilde{C}_r^t(p)$. It will be convenient to write the scalar masses for Q^A in the following form

$$m_{i_1 i_2 \dots i_{P_A}}^2 = 2 \left(\frac{\alpha_{\text{eff}}}{4\pi} \right)^2 \left(\frac{F}{M} \right)^2 \sum_{j=1}^{P_A} \sum_{u=1}^R c_2(\mathbf{r}_{i_j}^A) n(\mathbf{s}_{t_u}) \mathcal{E}_{i_j}^{t_u}(x, \{y_\ell\}), \quad (4.2)$$

where $\alpha_{\text{eff}} \equiv \frac{g_{\text{eff}}^2}{4\pi}$, M is the messenger scale and F/M is the effective SUSY-breaking scale. $c_2(\mathbf{r}_{i_j}^A)$ is the quadratic Casimir of the representation under which the field $Q_{i_1 i_2 \dots i_{P_A}}^A$ transforms with respect to the group G_{i_j} and the sum is over all the groups under which this field is charged. $n(\mathbf{s}_{t_u})$ is the Dynkin index of the representation under which the messenger fields T_B, \tilde{T}_B^\dagger transform with respect to the group G_{t_u} (e.g. $n = 1$ for a single set of $\mathbf{r} + \bar{\mathbf{r}}$ of $SU(r)$), and the sum is over the groups under which the messenger fields T_B, \tilde{T}_B^\dagger are charged. Finally, we have defined a general function $\mathcal{E}_{i_j}^{t_u}(x, \{y_\ell\})$ for matter charged under the gauge group G_{i_j} and a messenger charged under the gauge group G_{t_u} . This function provides the measure of suppression of the sfermion masses relative to the Minimal Gauge Mediation (MGM) case, and we shall consequently refer to it as “the sfermion mass suppression function.” The variables in the suppression function are defined as

$$x \equiv \frac{F}{M^2}, \quad y_\ell \equiv \frac{m_\ell}{M}, \quad \ell = 1, \dots, N-1, \quad (4.3)$$

where m_ℓ is the ℓ th mass eigenvalue of the gauge bosons in the diagonal basis of eq. (3.3).

In the following subsections we consider various examples. As our first example, we will review the two nodes quiver [20, 11, 21]. For three nodes quivers, we will consider all possible models, which may be useful in applications to the SM flavor texture. Finally, for four and five nodes, we will present some properties of the linear quiver, which appears e.g. in deconstructing extra dimensional models of gaugino mediation [9, 10].

4.1 Two nodes quiver

Here we consider the two nodes quiver, which is shown in fig. 7 for $N = 2$. For this quiver the mass-squared matrix reads

$$\mathcal{M}_V^2 = 2v_{12}^2 \begin{pmatrix} g_1^2 & -g_1 g_2 \\ -g_1 g_2 & g_2^2 \end{pmatrix}, \quad (4.4)$$

which includes the contribution from both L_{12}, \tilde{L}_{12} .³ The eigenvalues of the matrix are 0 and $m_1^2 = 2(g_1^2 + g_2^2)v_{12}^2$, corresponding to the mass-squared of the MSSM gauge bosons and the massive ones, respectively. Let us first review the results of [11], where the soft masses were calculated for chiral superfields charged under the first node, G_1 . To use the general formula (2.8), we first need the diagonalization matrix U of eq. (3.3), which in this case is given by

$$U = \frac{1}{\sqrt{g_1^2 + g_2^2}} \begin{pmatrix} g_1 & -g_2 \\ g_2 & g_1 \end{pmatrix}. \quad (4.5)$$

Plugging this matrix into eq. (3.11) and using the eigenvalues of the mass-squared matrix reproduces the form factor [20, 11, 21]

$$f_1^2(p^2) = \frac{m_1^4}{(p^2 - m_1^2)^2}, \quad g_{\text{eff}}^2 = \frac{g_1^2 g_2^2}{g_1^2 + g_2^2}. \quad (4.6)$$

Evaluating the integral of eq. (2.8) using the current correlators (A.2)-(A.4) in appendix A, gives the following result

$$\mathcal{E}_1^2(x, y) = \frac{1}{x^2} \left[\alpha_0(x) - \alpha_1(x, y) - y^2 \alpha_2(x, y) - \frac{2}{y^2} \beta_{-1}(x) + \beta_0(x) + \frac{2}{y^2} \beta_1(x, y) + \beta_2(x, y) \right], \quad (4.7)$$

where $y \equiv y_1$, the suppression function is defined in eq. (4.2) and the functions α, β are defined in eqs. (A.17)-(A.23). It is clear from eq. (4.6) that the sfermion mass becomes that of MGM (A.25) for $y \rightarrow \infty$ and goes to zero in the limit of $y \rightarrow 0$ as $\mathcal{E}_1^2(x, y) \approx y^2/6 + \mathcal{O}(y^3)$ for small x (see appendix A.2 for details about the limits of the functions α, β).

For matter charged under the second node, G_2 , a similar calculation using eq. (3.11) gives

$$f_2^2(p^2) = \left(\frac{\lambda_2 p^2 - m_1^2}{p^2 - m_1^2} \right)^2, \quad \lambda_2 \equiv \frac{g_2^2}{g_{\text{eff}}^2}. \quad (4.8)$$

Again, evaluating the integral of eq. (2.8) yields

$$\mathcal{E}_2^2(x, y, \lambda_2) = \frac{1}{x^2} \left[\alpha_0(x) - (1 - \lambda_2^2) \alpha_1(x, y) - (1 - \lambda_2)^2 y^2 \alpha_2(x, y) - \frac{2(1 - \lambda_2)}{y^2} \beta_{-1}(x) + \beta_0(x) + \frac{2(1 - \lambda_2)}{y^2} \beta_1(x, y) + (1 - \lambda_2)^2 \beta_2(x, y) \right]. \quad (4.9)$$

³We normalize the trace of the generators of the group G_i in the standard way $\text{Tr}(t_i^m t_i^n) = \delta^{mn}/2$.

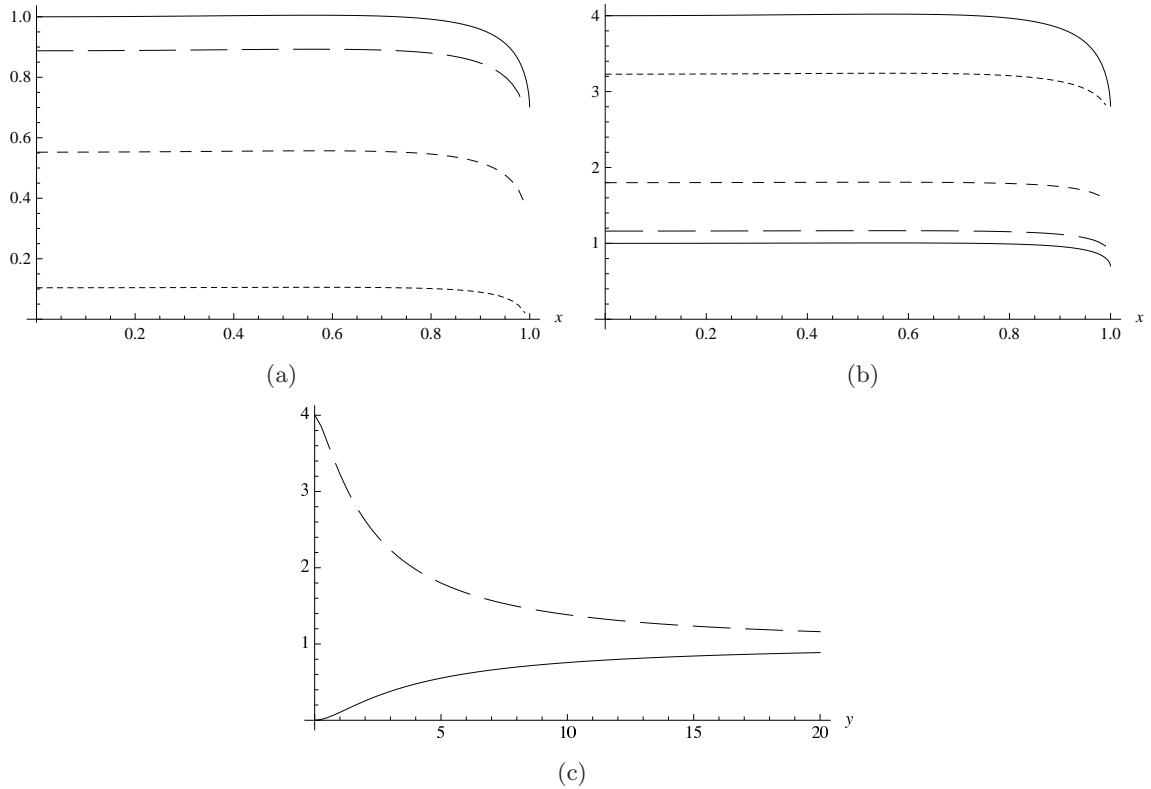

Figure 3. The suppression function $\mathcal{E}_1^2(x, y)$ for the first node (a) and $\mathcal{E}_2^2(x, y, 2)$ for the second node (b) of the two nodes quiver is shown for various values of y , with the long, intermediate and short dashed lines corresponding to $y = 20, 5, 1$, respectively. For $y \rightarrow \infty$, the MGM limit is recovered (solid line) for both (a) and (b), while for (b) the upper solid line corresponds to the second MGM limit $y \rightarrow 0$. In (c) the functions $\mathcal{E}_1^2(0, y)$ (solid line) and $\mathcal{E}_2^2(0, y, 2)$ (dashed line) are shown. In this figure we chose $g_1 = g_2$ and hence $\lambda_2 = 2$.

For this suppression function there are two limits which can be understood quite easily, viz. the limit $y \rightarrow \infty$ yields the MGM result (A.25), as the Higgsing produces the diagonal gauge group with the gauge coupling g_{eff} , while the opposite limit $y \rightarrow 0$ gives again the MGM result (A.25), but with gauge coupling g_2 , instead. Hence, in the limit $y \rightarrow 0$,

$$\mathcal{E}_2^2(x, 0, \lambda_2) = \frac{\lambda_2^2}{x^2} [\alpha_0(x) + \beta_0(x)] . \quad (4.10)$$

Note that in this limit the suppression function \mathcal{E}_2^2 is larger than in the $y \rightarrow \infty$ limit, since $\lambda_2^2 = (1 + g_2^2/g_1^2)^2$ is greater than one for non-zero g_2 .

In fig. 3, we display the functions $\mathcal{E}_1^2(x, y)$ and $\mathcal{E}_2^2(x, y, \lambda_2)$ for various values of y , for equal gauge couplings (and hence $\lambda_2 = 2$) and we also present $\mathcal{E}_1^2(0, y), \mathcal{E}_2^2(0, y, 2)$, i.e. the small x regime interpolation between the above mentioned MGM limits.

Finally, the suppression of the sfermion masses with respect to MGM is $(\mathcal{E}_1^2)^{-1} : (\mathcal{E}_2^2)^{-1} = 9.6 : 0.31$, for $y = 1$, equal gauge couplings and small x . We see that when the matter and messenger are charged under different nodes of the quiver, the suppression is relatively large, even though we consider a “hybrid gaugino-gauge mediation” case, where the messenger scale is equal to the mass of the heavy gauge particles, $M = m_1$.

4.2 Three nodes quivers

In this subsection we shall calculate the sfermion soft masses and the link field soft masses for all three nodes quiver theories with a single pair of messengers charged under one or two of the nodes.

4.2.1 The basic three nodes quiver – model q

The fundamental quiver diagram is a triangle with a single pair of messengers charged under one of the nodes, which we will take to be G_3 (see fig. 4a); the other cases can be easily obtained from this one. The mass-squared matrix for the gauge bosons is

$$\mathcal{M}_V^2 = 2 \begin{pmatrix} g_1^2 (v_{12}^2 + v_{13}^2) & -g_1 g_2 v_{12}^2 & -g_1 g_3 v_{13}^2 \\ -g_1 g_2 v_{12}^2 & g_2^2 (v_{12}^2 + v_{23}^2) & -g_2 g_3 v_{23}^2 \\ -g_1 g_3 v_{13}^2 & -g_2 g_3 v_{23}^2 & g_3^2 (v_{23}^2 + v_{13}^2) \end{pmatrix}, \quad (4.11)$$

and it has the eigenvalues 0 and

$$m_{1,2}^2 = A_{12} + A_{23} + A_{13} \mp \sqrt{(A_{12} + A_{23} + A_{13})^2 - 4P_2(\{g_i^2\})P_2(\{v_{ij}^2\})}, \quad (4.12)$$

$$A_{ij} \equiv (g_i^2 + g_j^2) v_{ij}^2,$$

where $P_2(\{x_i\}) \equiv x_1 x_2 + x_2 x_3 + x_1 x_3$. After plugging the elements of the matrix U , which diagonalize the above mass-squared matrix as in eq. (3.3), into eq. (3.11), one finds the following form factors for the matter Q_1 , Q_2 and Q_3 , respectively,

$$f_1^3(p^2) = \left(\frac{m_1^2 m_2^2 - \zeta_{13} M^2 p^2}{(p^2 - m_1^2)(p^2 - m_2^2)} \right)^2, \quad \zeta_{ij} M^2 \equiv \frac{2g_i^2 g_j^2 v_{ij}^2}{g_{\text{eff}}^2},$$

$$f_2^3(p^2) = \left(\frac{m_1^2 m_2^2 - \zeta_{23} M^2 p^2}{(p^2 - m_1^2)(p^2 - m_2^2)} \right)^2, \quad (4.13)$$

$$f_3^3(p^2) = \left(\frac{m_1^2 m_2^2 - (\zeta_{23} + \zeta_{13} + 2\eta_{12} \lambda_3) M^2 p^2 + \lambda_3 p^4}{(p^2 - m_1^2)(p^2 - m_2^2)} \right)^2, \quad \eta_{ij} M^2 \equiv A_{ij}, \quad \lambda_i \equiv \frac{g_i^2}{g_{\text{eff}}^2}.$$

The integrals (2.8) have a similar form for matter charged under any of the nodes of the various quiver models, so it is convenient to define the following function

$$\mathcal{K}(x, y_1, y_2, z_1, z_2) \equiv \frac{1}{x^2} \left[\alpha_0(x) - \frac{2(y_1^2 + y_2^2 - z_1)}{y_1^2 y_2^2} \beta_{-1}(x) + \beta_0(x) \right]$$

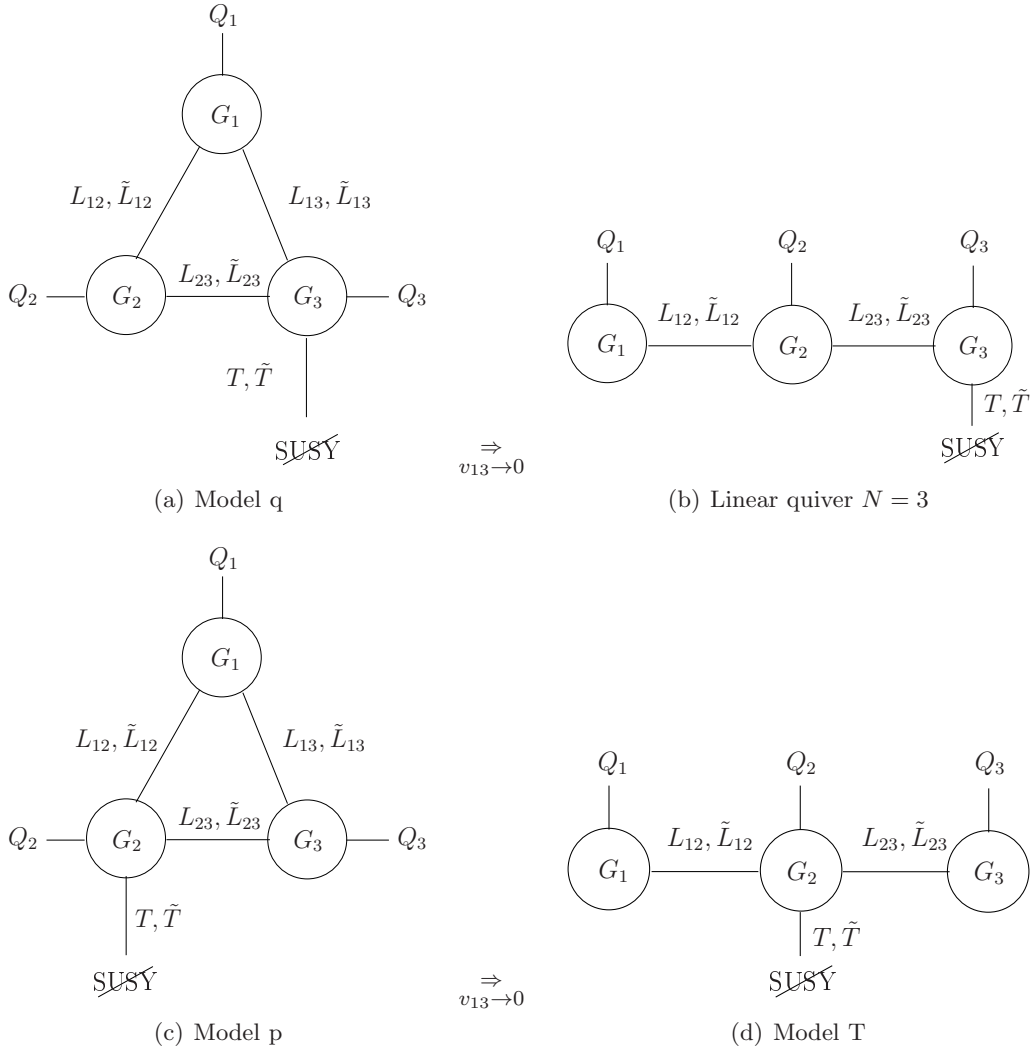

Figure 4. Quiver diagrams representing the theories with the chiral matter superfields Q_i charged under G_i and link fields L_{ij}, \tilde{L}_{ij} , connecting the 3 gauge groups. In (a,b) the messenger fields T, \tilde{T} are charged only under G_3 , while in (c,d) they are only charged under G_2 . (b) is obtained from (a) by taking the limit $v_{13} \rightarrow 0$ and likewise (d) is obtained from (c) in the same limit.

$$\begin{aligned}
& + \sum_{\substack{i,j=1 \\ i \neq j}}^2 \frac{1}{(y_i^2 - y_j^2)^2} \left(\frac{(y_j^2 - z_1 + y_i^2 z_2) \left(y_j^4 + (y_i^2 + y_j^2) z_1 + y_i^4 z_2 - 3y_i^2 y_j^2 (1 + z_2) \right)}{y_i^2 - y_j^2} \alpha_1(x, y_i) \right. \\
& - y_i^2 (y_j^2 - z_1 + y_i^2 z_2)^2 \alpha_2(x, y_i) - \frac{2(y_j^2 - z_1 + y_i^2 z_2) \left(y_j^4 + y_i^2 z_1 - y_i^2 y_j^2 (2 + z_2) \right)}{y_i^2 (y_i^2 - y_j^2)} \beta_1(x, y_i) \\
& \left. + (y_j^2 - z_1 + y_i^2 z_2)^2 \beta_2(x, y_i) \right) \Bigg], \tag{4.14}
\end{aligned}$$

which corresponds to the generic form factor

$$f(p^2) = \left(\frac{m_1^2 m_2^2 - z_1 M^2 p^2 + z_2 p^4}{(p^2 - m_1^2)(p^2 - m_2^2)} \right)^2 . \quad (4.15)$$

Now it is possible to see that the integrals (2.8) yield the following suppression functions

$$\begin{aligned} \mathcal{E}_1^3(x, y_1, y_2, \zeta_{13}) &= \mathcal{K}(x, y_1, y_2, \zeta_{13}, 0) , \\ \mathcal{E}_2^3(x, y_1, y_2, \zeta_{23}) &= \mathcal{K}(x, y_1, y_2, \zeta_{23}, 0) , \\ \mathcal{E}_3^3(x, y_1, y_2, \zeta_{23}, \zeta_{13}, \eta_{12}, \lambda_3) &= \mathcal{K}(x, y_1, y_2, \zeta_{23} + \zeta_{13} + 2\eta_{12}\lambda_3, \lambda_3) , \end{aligned} \quad (4.16)$$

for the first, the second and the third node, respectively, of model q.

As explained in more detail in appendix A.2, the functions α, β simplify in the limit $x \rightarrow 0$, which is a good approximation for $x \lesssim 0.7$, where in turn the function \mathcal{K} simplifies as

$$\begin{aligned} \mathcal{K}(0, y_1, y_2, z_1, z_2) &= 1 - \frac{2(y_1^2 + y_2^2 - z_1)}{y_1^2 y_2^2} + \sum_{\substack{i,j=1 \\ i \neq j}}^2 \frac{1}{(y_i^2 - y_j^2)^2} \left((y_j^2 - z_1 + y_i^2 z_2)^2 \tilde{\beta}_2(y_i) \right. \\ &\quad \left. - \frac{2(y_j^2 - z_1 + y_i^2 z_2) \left(y_j^4 + y_i^2 z_1 - y_i^2 y_j^2 (2 + z_2) \right)}{y_i^2 (y_i^2 - y_j^2)} \tilde{\beta}_1(y_i) \right) , \end{aligned} \quad (4.17)$$

with $\tilde{\beta}_{1,2}(y) = \lim_{x \rightarrow 0} \beta_{1,2}(x, y)/x^2$ being the limits given in eqs. (A.28) and (A.29).

Finally, the suppression of the sfermion masses with respect to MGM is $(\mathcal{E}_1^3)^{-1} : (\mathcal{E}_2^3)^{-1} : (\mathcal{E}_3^3)^{-1} = 9.6 : 9.6 : 0.15$, for $y_1 = 1$, equal gauge couplings, equal VEVs and small x .

4.2.2 Model p

Although this model is equivalent to the previous one – the two are related by moving the messengers T, \tilde{T} from the node G_3 to G_2 , as depicted in fig. 4c – we introduce it to simplify the discussion of other, non-equivalent models. By symmetry, the result for the suppression functions is

$$\begin{aligned} \mathcal{E}_1^2(x, y_1, y_2, \zeta_{12}) &= \mathcal{K}(x, y_1, y_2, \zeta_{12}, 0) , \\ \mathcal{E}_2^2(x, y_1, y_2, \zeta_{12}, \zeta_{23}, \eta_{13}, \lambda_2) &= \mathcal{K}(x, y_1, y_2, \zeta_{12} + \zeta_{23} + 2\eta_{13}\lambda_2, \lambda_2) , \\ \mathcal{E}_3^2(x, y_1, y_2, \zeta_{23}) &= \mathcal{K}(x, y_1, y_2, \zeta_{23}, 0) . \end{aligned} \quad (4.18)$$

4.2.3 The linear quiver $N = 3$

Using model q, one obtains the suppression functions for the linear quiver with $N = 3$ nodes, as shown in fig. 4b, by taking the limit $v_{13} \rightarrow 0$. The masses m_ℓ of eq. (4.12) become their respective limit for vanishing v_{13} . Hence, the result for the suppression functions corresponding to matter charged under any of the three nodes of the linear quiver reads

$$\begin{aligned} \mathcal{E}_1^3(x, y_1, y_2) &= \mathcal{K}(x, y_1, y_2, 0, 0) , \\ \mathcal{E}_2^3(x, y_1, y_2, \zeta_{23}) &= \mathcal{K}(x, y_1, y_2, \zeta_{23}, 0) , \\ \mathcal{E}_3^3(x, y_1, y_2, \zeta_{23}, \eta_{12}, \lambda_3) &= \mathcal{K}(x, y_1, y_2, \zeta_{23} + 2\eta_{12}\lambda_3, \lambda_3) . \end{aligned} \quad (4.19)$$

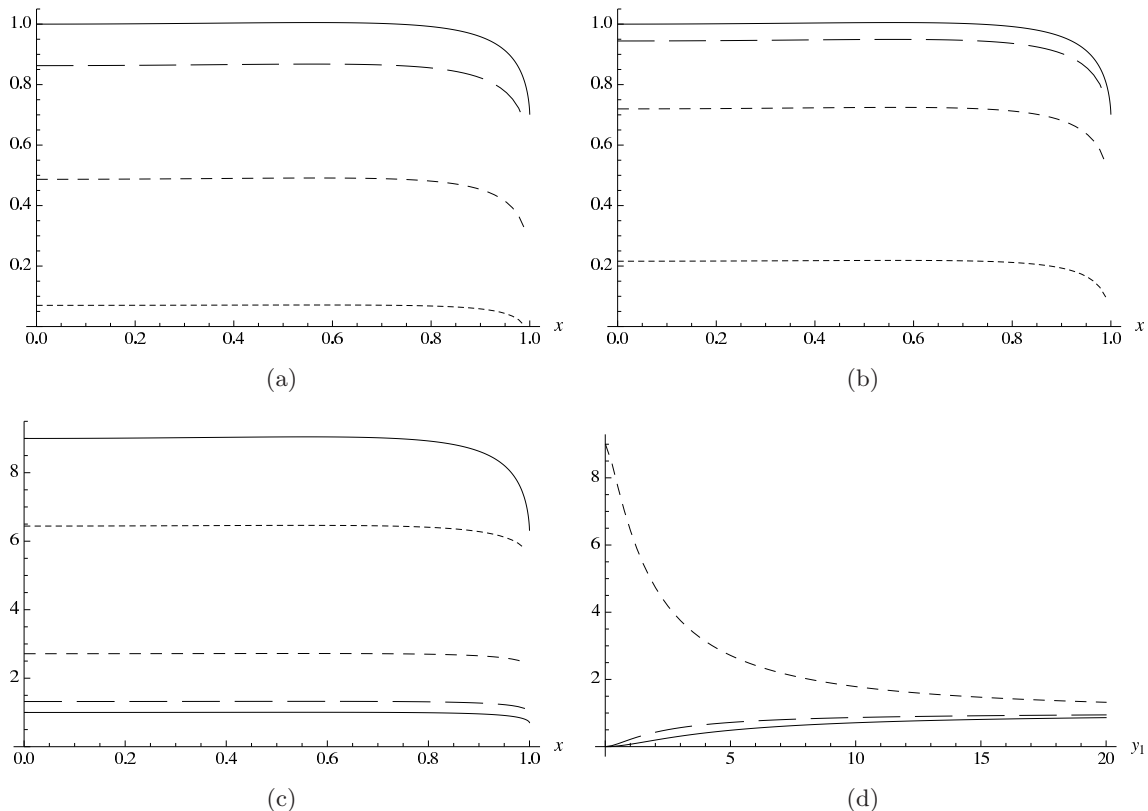

Figure 5. The suppression functions (a) $\mathcal{E}_1^3(x, y_1, y_2)$ for the first node, (b) $\mathcal{E}_2^3(x, y_1, y_2, y_2^2)$ for the second node and (c) $\mathcal{E}_3^3(x, y_1, y_2, y_2^2, y_1^2, 3)$ for the third node of the linear three node quiver for various values of y_1 , with the long, intermediate and short dashed lines corresponding to $y_1 = 20, 5, 1$, respectively. For the first two nodes, the MGM limit is recovered (solid line) for $y \rightarrow \infty$, while for the third node the two solid lines correspond to the two MGM limits, $y \rightarrow \infty$ and $y \rightarrow 0$. Finally, (d) depicts all the functions $\mathcal{E}_{1,2,3}^3$ as function of y_1 for small x with solid, long dashed and short dashed lines, respectively. In this figure, we have chosen $g_1 = g_2 = g_3$, $v_{12} = v_{23}$ and hence $y_2 = \sqrt{3}y_1$, $\zeta = y_2^2$, $\lambda_1 = 3y_2^2$ and $\lambda_2 = 3$.

In fig. 5, we display the functions $\mathcal{E}_{1,2,3}^3$ for various values of y_1 , for equal VEVs and equal gauge couplings (and hence $y_2 = \sqrt{3}y_1$, $\zeta_{23} = y_2^2$, $\eta_{12} = y_2^2/3$ and $\lambda_3 = 3$) and we also present $\mathcal{E}_{1,2,3}^3$ in the small x regime as functions of y_1 . In the limit of $y_{1,2} \rightarrow \infty$ (i.e. taking $v_{12}, v_{23} \rightarrow \infty$), the function \mathcal{K} of eq. (4.14) reveals that, for each node, the suppression function reduces to the MGM one (A.25). In the opposite limit, $y_{1,2} \rightarrow 0$ (i.e. taking $v_{12}, v_{23} \rightarrow 0$), the suppression function goes to zero for matter charged under the first and second nodes, while it gives the MGM result with a factor of λ_3^2 for matter charged under the third node G_3 ,

$$\mathcal{E}_3^3(x, 0, 0, 0, \lambda_3) = \frac{\lambda_3^2}{x^2} (\alpha_0(x) + \beta_0(x)) . \quad (4.20)$$

Finally, the suppression of the sfermion masses with respect to MGM is $(\mathcal{E}_1^3)^{-1} : (\mathcal{E}_2^3)^{-1} :$

$(\mathcal{E}_3^3)^{-1} = 14.3 : 4.6 : 0.16$, for $y_1 = 1$, equal gauge couplings, equal VEVs and small x . In this case, the suppression is somewhat larger relative to the previous examples, for matter charged under G_1 .

4.2.4 Model T

Similarly, using model p, it is easy to obtain the suppression functions for model T shown in fig. 4d, by taking the limit $v_{13} \rightarrow 0$. The masses m_ℓ become their respective limit of vanishing v_{13} . Hence, the result for the suppression functions reads

$$\begin{aligned}\mathcal{E}_1^2(x, y_1, y_2, \zeta_{12}) &= \mathcal{K}(x, y_1, y_2, \zeta_{12}, 0) , \\ \mathcal{E}_2^2(x, y_1, y_2, \zeta_{12}, \zeta_{23}, \lambda_2) &= \mathcal{K}(x, y_1, y_2, \zeta_{12} + \zeta_{23}, \lambda_2) , \\ \mathcal{E}_3^2(x, y_1, y_2, \zeta_{23}) &= \mathcal{K}(x, y_1, y_2, \zeta_{23}, 0) .\end{aligned}\tag{4.21}$$

The ratio of suppression with respect to MGM is $(\mathcal{E}_1^2)^{-1} : (\mathcal{E}_2^2)^{-1} : (\mathcal{E}_3^2)^{-1} = 4.6 : 0.18 : 4.6$, for $y_1 = 1$, equal gauge couplings, equal VEVs and small x .

4.2.5 Bifundamental messenger models

Here we consider models in which the messenger fields are charged under two of the gauge groups, G_2 and G_3 . To compute the sfermion masses in the p+q model (fig. 6a), using eq. (4.2), all we need is to superpose the suppression functions of models q and p, weighted by the Dynkin indices $n(\mathbf{s}_2)$, $n(\mathbf{s}_3)$ of the messenger pair on $G_{2,3}$, respectively; one thus obtains the factors

$$n(\mathbf{s}_2)\mathcal{E}_i^2 + n(\mathbf{s}_3)\mathcal{E}_i^3 .\tag{4.22}$$

For instance, when both groups are $SU(r)$, the suppression factors of model p+q are $r(\mathcal{E}_i^2 + \mathcal{E}_i^3)$.

For model F (fig. 6b), the suppression factors can be obtained either as the limit $v_{13} \rightarrow 0$ of model p+q or, equivalently, as the sum of the linear quiver $N = 3$ and model T factors, as given in eq. (4.22). Finally, model Λ can be obtained e.g. from model p+q by taking the limit $v_{23} \rightarrow 0$.

4.3 More nodes

Linear quivers, presented in fig. 7, have a particularly simple structure, which we consider in this subsection. For equal gauge couplings g and equal VEVs v , the form factors were computed for arbitrary N in [20]. The vector boson mass-squared matrix takes the form

$$\mathcal{M}_V^2 = 2g^2v^2 \begin{pmatrix} 1 & -1 & & & \\ -1 & 2 & -1 & & \\ & \ddots & \ddots & \ddots & \\ & & & -1 & 2 & -1 \\ & & & & -1 & 1 \end{pmatrix} .\tag{4.23}$$

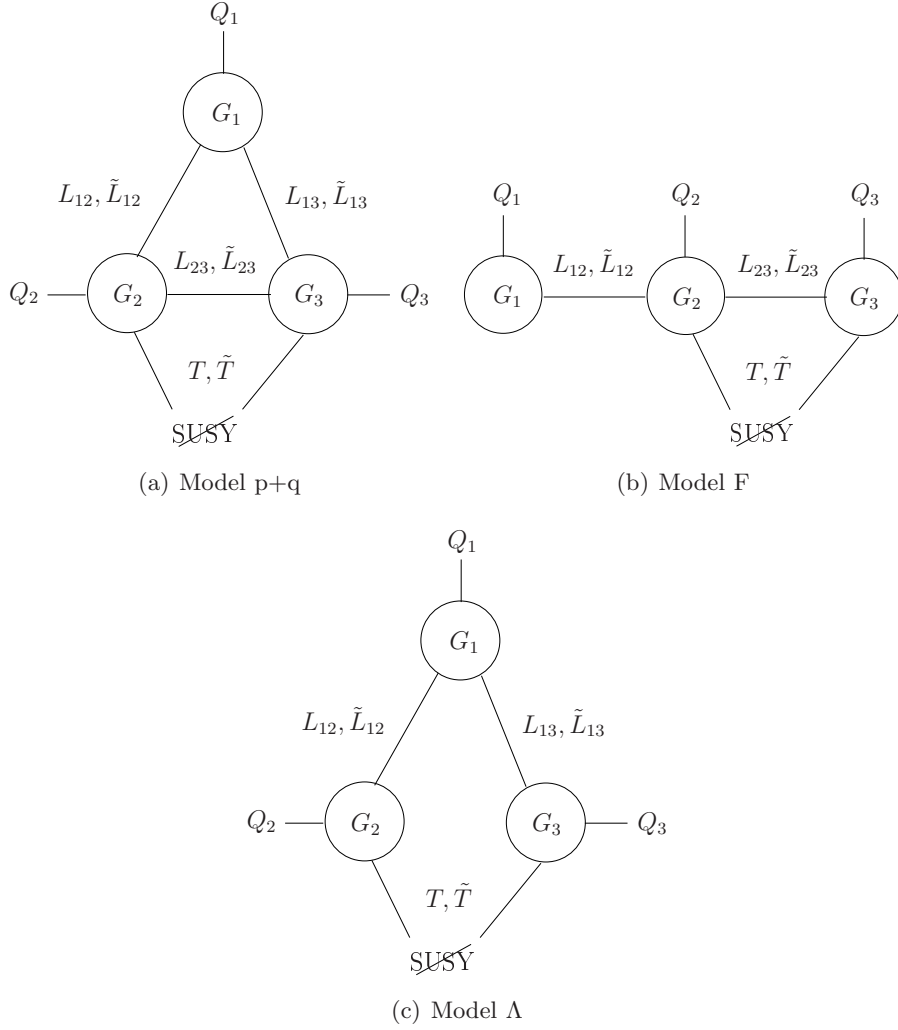

Figure 6. Quiver diagrams representing the theories with the chiral matter superfields Q_i charged under G_i and link fields L_{ij}, \tilde{L}_{ij} , connecting the 3 gauge groups. The messenger fields $T(\tilde{T})$ are (anti-)bifundamentals of $G_2 \times G_3$.

The eigenvalues and the diagonalizing matrix U , respectively, are [22, 23, 9]:

$$m_k^2 = 8g^2v^2 \sin^2\left(\frac{(k-1)\pi}{2N}\right), \quad U_{ij} = \left(\frac{2}{2^{\delta_{i1}}N}\right)^{1/2} \cos\frac{(i-1)(2j-1)\pi}{2N}, \quad (4.24)$$

where $1 \leq k \leq N$ (in this formula a slightly different convention is used: $m_1 = 0$, $m_k \neq 0$ for $k > 1$). Using eq. (4.24) in eq. (3.11) we recover the result of [20]. In the limit of large N , the extra dimension setting is recovered (see e.g. [24, 7, 8, 25]). In the case of general VEVs and couplings such a compact analytic expression does not materialize and one has to diagonalize a generic tridiagonal $N \times N$ matrix in order to find the form factors.

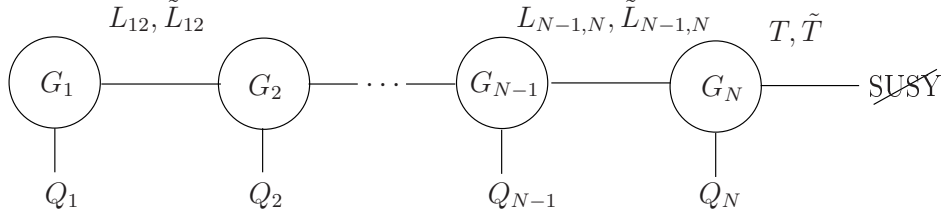

Figure 7. A quiver diagram representing a class of quiver theories with the chiral matter superfields Q_i charged under G_i and $N - 1$ link fields $L_{i,i+1}, \tilde{L}_{i,i+1}$, $i = 1, \dots, N - 1$, connecting the N gauge groups and, finally, the messenger fields T, \tilde{T} are charged only under the last group G_N . We call this class of models linear quivers.

We will consider in detail some properties in two examples – the linear quivers of fig. 7 with $N = 4, 5$. In the $N = 4$ case, the mass-squared matrix for the gauge bosons is given by

$$\mathcal{M}_V^2 = 2 \begin{pmatrix} g_1^2 v_{12}^2 & -g_1 g_2 v_{12}^2 & 0 & 0 \\ -g_1 g_2 v_{12}^2 & g_2^2 (v_{12}^2 + v_{23}^2) & -g_2 g_3 v_{23}^2 & 0 \\ 0 & -g_2 g_3 v_{23}^2 & g_3^2 (v_{23}^2 + v_{34}^2) & -g_3 g_4 v_{34}^2 \\ 0 & 0 & -g_3 g_4 v_{34}^2 & g_4^2 v_{34}^2 \end{pmatrix}, \quad (4.25)$$

and the eigenvalues are in general quite complicated. The generic form factor for matter charged under the first node G_1 is

$$f_1^4(p^2) = \left(\frac{m_1^2 m_2^2 m_3^2}{(p^2 - m_1^2)(p^2 - m_2^2)(p^2 - m_3^2)} \right)^2, \quad (4.26)$$

giving rise to the suppression function

$$\begin{aligned} \mathcal{E}_1^4(x, y_1, y_2, y_3) = & \frac{1}{x^2} \left[\alpha_0(x) - 2 \frac{y_1^2 y_2^2 + y_2^2 y_3^2 + y_1^2 y_3^2}{y_1^2 y_2^2 y_3^2} \beta_{-1}(x) + \beta_0(x) \right. \\ & - \sum_{\substack{i,j,k \\ \text{cyclic}}} \left(\frac{y_j^4 y_k^4 [5y_i^4 - 3(y_j^2 + y_k^2)y_i^2 + y_j^2 y_k^2]}{(y_i^2 - y_j^2)^3 (y_i^2 - y_k^2)^3} \alpha_1(x, y_i) \right. \\ & \quad \left. + \frac{y_j^4 y_k^4}{(y_i^2 - y_j^2)^2 (y_i^2 - y_k^2)^2} (y_i^2 \alpha_2(x, y_i) + \beta_2(x, y_i)) \right. \\ & \quad \left. + \frac{y_j^4 y_k^4 [6y_i^4 - 4(y_j^2 + y_k^2)y_i^2 + y_j^2 y_k^2]}{y_i^2 (y_i^2 - y_j^2)^3 (y_i^2 - y_k^2)^3} \beta_1(x, y_i) \right) \left. \right]. \quad (4.27) \end{aligned}$$

Let us stress that this suppression function is valid for any g_i, v_{ij} .

For the remaining nodes, for simplicity, we present just the case of equal couplings and equal VEVs. The form factors can be computed straightforwardly from eqs. (3.11) and (4.24).

The corresponding suppression functions $\mathcal{E}_i^4(x, y_1)$ can be expressed in the form of eq. (A.24). The resulting coefficients of the suppression functions are given in table 1. The suppression of the sfermion masses with respect to MGM is $(\mathcal{E}_1^4)^{-1} : (\mathcal{E}_2^4)^{-1} : (\mathcal{E}_3^4)^{-1} : (\mathcal{E}_4^4)^{-1} = 16.2 : 9.3 : 2.3 : 0.098$, for $y_1 = 1$, equal gauge couplings, equal VEVs and small x .

For the linear quiver of fig. 7 with $N = 5$, the mass-squared matrix for the gauge bosons is given by

$$\mathcal{M}_V^2 = 2 \begin{pmatrix} g_1^2 v_{12}^2 & -g_1 g_2 v_{12}^2 & 0 & 0 & 0 \\ -g_1 g_2 v_{12}^2 & g_2^2 (v_{12}^2 + v_{23}^2) & -g_2 g_3 v_{23}^2 & 0 & 0 \\ 0 & -g_2 g_3 v_{23}^2 & g_3^2 (v_{23}^2 + v_{34}^2) & -g_3 g_4 v_{34}^2 & 0 \\ 0 & 0 & -g_3 g_4 v_{34}^2 & g_4^2 (v_{34}^2 + v_{45}^2) & -g_4 g_5 v_{45}^2 \\ 0 & 0 & 0 & -g_4 g_5 v_{45}^2 & g_5^2 v_{45}^2 \end{pmatrix}, \quad (4.28)$$

and again the eigenvalues are in general quite complicated. The generic form factor for matter charged under the first node G_1 is

$$f_1^5(p^2) = \left(\frac{m_1^2 m_2^2 m_3^2 m_4^2}{(p^2 - m_1^2)(p^2 - m_2^2)(p^2 - m_3^2)(p^2 - m_4^2)} \right)^2. \quad (4.29)$$

The form factors for the other nodes can be computed as in the previous example. For equal g_i and v_{ij} , the resulting coefficients of the suppression functions are given in tables 2, 3. The suppression of the sfermion masses with respect to MGM is $(\mathcal{E}_1^5)^{-1} : (\mathcal{E}_2^5)^{-1} : (\mathcal{E}_3^5)^{-1} : (\mathcal{E}_4^5)^{-1} : (\mathcal{E}_5^5)^{-1} = 17.2 : 12.4 : 5.6 : 1.3 : 0.069$, for $y_1 = 1$, equal gauge couplings, equal VEVs and small x .

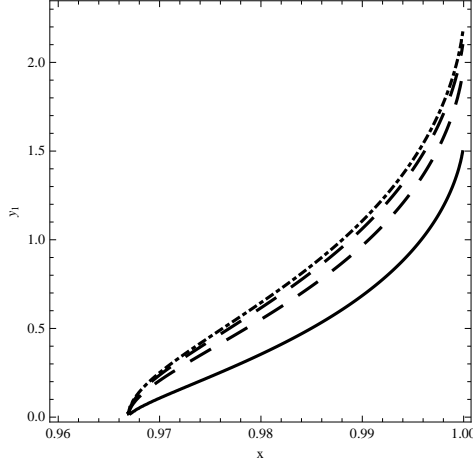

Figure 8. Contour plot illustrating the points in the (x, y_1) -plane where the suppression function \mathcal{E}_1^N vanishes, for $N = 2, 3, 4, 5$. The $N = 2$ line is the lowest one while for each increasing N the line moves slightly upwards in the plot. We have taken all couplings equal $g_i = g$ and all VEVs equal $v_{ij} = v$ in this plot. The tachyonic regime in each case is below its corresponding contour.

Finally, let us discuss a feature of the sfermion masses, found in [11], viz. they become tachyonic in the large $x \lesssim 1$ regime. We consider here the tachyonic regime in the case of the linear quiver (fig. 7) for a sfermion charged under G_1 , whose suppression function is \mathcal{E}_1^N , as the number of nodes N increases. The result for $N = 2, 3, 4, 5$ is presented in fig. 8; one can see that the tachyonic regime increases with N , but only to a certain extent.

5 Discussion

In this work, we computed the two-loop contributions to the scalar soft masses in supersymmetric quiver gauge theories with a general matter content. Our results are valid in the hybrid regime – when the messenger scale M is comparable to the masses m_ℓ of the additional gauge particles. On the other hand, three-loop contributions become important when m_ℓ/M is small (see e.g. eq. (5.9) in [13] for a recent evaluation of the relative 3-loops/2-loops contribution in some cases). The suppression of sfermion masses is significant – even in the hybrid regime – when the matter and messengers of SUSY breaking are not charged under the same group.

In phenomenological applications, the unbroken gauge group of the quiver gauge theory must be the SM one at low energy. This can be achieved, e.g., by taking $G_i = SU(5)$ in each node with, say, only G_1 being broken to $SU(3) \times SU(2) \times U(1)$. In this example, unification is manifest (if the Higgses are charged only under G_1). Moreover, such a grand unified theory may be perturbative if the number of nodes is sufficiently small (up to about five nodes).

To find the physical pole masses, one should consider, of course, the RGE from the messenger scale down to the weak scale. This can be done straightforwardly, as was done recently for some two nodes examples in [12, 13]. We have done it in additional examples and found, in particular, that the rather large suppression of the scalar masses gives rise to exotic sparticle spectra, even in the hybrid case. In particular, similar to the results in [12, 13], the stop mass can be sufficiently small – to provide an explanation to the hierarchy problem – even in models where the gaugino masses vanish to leading order in SUSY breaking (which is a typical property of quiver models that have a dynamical embedding in some higher energy theory [3]), and both the right-handed as well as the left-handed sleptons can be lighter than the bino in the low-scale mediation regime (when the messenger scale M is comparable to the effective SUSY-breaking scale F/M).

It is interesting to mention that, in the limit of small m_ℓ/M , the Higgs mass gets a contribution which is absent in the MSSM [26, 27]; this comes from the D-terms of the heavy gauge bosons, which do not decouple completely in presence of SUSY breaking. In some parts of the parameter space this can raise the Higgs mass above 114 GeV in a way which is compatible with naturalness constraints; see e.g. the recent works [5, 13]. For the mechanism to be effective, m_ℓ should be of the order of a few TeV. Furthermore, the part of parameter space in which this effect is not negligible is not compatible with the usual gauge coupling unification; it could be compatible with accelerated unification [28], instead.

Quiver gauge theories that have dynamical embedding in (deformed) SQCD are of particular interest. In this paper, for simplicity, we focused on models with a minimal messenger sector. The generalization of our analysis to any weakly coupled messengers sector – in particular, to those realized in the dynamical embedding of [3] – is straightforward, and can be done as in [13].

The analysis of this work lays the grounds for further investigation of the various constraints which arise in “(de)constructing a natural and flavorful supersymmetric standard model,” as in [5]. Addressing the texture of the Yukawa couplings and the masses of the higgsinos and Higgs particles – hopefully in an appropriate way to ameliorate the flavor puzzle and the $\mu/B\mu$ problem – can be done by separating the three generations and Higgs superfields on different nodes of the quiver. Consequently, the smallness of parameters in the Yukawa matrices and the Higgs mass terms is natural, since they arise from higher dimension operators in the effective action (being suppressed e.g. by the SQCD scale of the high-energy embedding theory discussed above). Moreover, inverted sparticle hierarchies – which are less constrained by current LHC limits – are obtained when the first two generations and the messengers are charged under the same nodes. The detailed investigation of this interesting application is left for future work.

Finally, in this note we have limited our analysis to quiver models with fields in the bifundamental plus anti-bifundamental representation in each of the links. A phenomenologically appealing extension of our investigation is to consider more generic representations for the link fields; see e.g. the recent work [29].

Acknowledgments

We thank Zohar Komargodski for discussions. This work was supported in part by the BSF – American-Israel Bi-National Science Foundation, and by a center of excellence supported by the Israel Science Foundation (grant number 1665/10). SBG is supported by the Golda Meir Foundation Fund.

A Integrals

We shall consider here quivers coupled to a single pair of messengers; see eq. (4.1). This can be generalized straightforwardly to a general messenger sector, as discussed in section 2. The sparticle masses are given by eq. (4.2), where we presented the suppression functions

$$\mathcal{E}_i^t(x, \{y_\ell\}) \equiv -\frac{8}{M^2 x^2 n(\mathbf{s}_t)} \int d^4 p \frac{f_i^t(p^2)}{p^2} \left[3\tilde{C}_1(p^2) - 4\tilde{C}_{1/2}(p^2) + \tilde{C}_0(p^2) \right] , \quad (\text{A.1})$$

where M and x are defined in eqs. (4.1) and (4.3), respectively. The current correlators in eq. (2.5), in this case, are given by [14]

$$\tilde{C}_0^t(p^2) = n(\mathbf{s}_t) \int \frac{d^4 q}{(2\pi)^4} \frac{1}{[q^2 + m_+^2] [(p+q)^2 + m_-^2]}, \quad (\text{A.2})$$

$$\tilde{C}_{1/2}^t(p^2) = -\frac{n(\mathbf{s}_t)}{p^2} \int \frac{d^4 q}{(2\pi)^4} \sum_{\pm} \left(\frac{1}{(p+q)^2 + m_{\pm}^2} \right) \frac{p \cdot q}{q^2 + m_0^2}, \quad (\text{A.3})$$

$$\begin{aligned} \tilde{C}_1^t(p^2) = & -\frac{n(\mathbf{s}_t)}{3p^2} \int \frac{d^4 q}{(2\pi)^4} \left[\sum_{\pm} \left(\frac{(p+q) \cdot (p+2q)}{[q^2 + m_{\pm}^2] [(p+q)^2 + m_{\pm}^2]} - \frac{4}{q^2 + m_{\pm}^2} \right) \right. \\ & \left. + \frac{4(p+q) \cdot q + 8m_0^2}{[q^2 + m_0^2] [(p+q)^2 + m_0^2]} \right], \quad (\text{A.4}) \end{aligned}$$

where $m_0 = M$ is the mass of the fermionic messengers and $m_{\pm}^2 = M^2 \pm F$ are the bosonic masses. We define the following symbol [30]

$$\begin{aligned} & \langle m_{11}, \dots, m_{1n_1} | m_{21}, \dots, m_{2n_2} | m_{31}, \dots, m_{3n_3} \rangle \\ & \equiv \int \frac{d^d p d^d q}{\pi^d} \prod_{i=1}^{n_1} \prod_{j=1}^{n_2} \prod_{k=1}^{n_3} \frac{1}{p^2 + m_{1i}^2} \frac{1}{q^2 + m_{2j}^2} \frac{1}{(p-q)^2 + m_{3k}^2}. \quad (\text{A.5}) \end{aligned}$$

Some useful results, evaluated in dimensional regularization with $d = 4 - 2\epsilon$, are [30, 31]

$$\begin{aligned} \langle m_a | m_b | m_c \rangle = & \frac{1}{-1 + 2\epsilon} \left(m_a^2 \langle m_a, m_a | m_b | m_c \rangle + m_b^2 \langle m_b, m_b | m_c | m_a \rangle \right. \\ & \left. + m_c^2 \langle m_c, m_c | m_a | m_b \rangle \right), \quad (\text{A.6}) \end{aligned}$$

$$\begin{aligned} \langle m_a, m_a | m_b | m_c \rangle = & \frac{1}{2\epsilon^2} + \frac{1/2 - \gamma - \log m_a^2}{\epsilon} + \gamma^2 - \gamma + \frac{\pi^2}{12} \\ & + (2\gamma - 1) \log m_a^2 + \log^2 m_a^2 - \frac{1}{2} + h(a, b), \quad (\text{A.7}) \end{aligned}$$

where we have defined the function

$$h(a, b) \equiv \int_0^1 dt \left(1 + \text{Li}_2(1 - \mu^2) - \frac{\mu^2}{1 - \mu^2} \log \mu^2 \right), \quad \mu^2 \equiv \frac{at + b(1-t)}{t(1-t)}, \quad (\text{A.8})$$

with $a \equiv m_b^2/m_a^2$ and $b \equiv m_c^2/m_a^2$. It turns out that the integral in eq. (A.7) is infrared divergent in the limit $m_a \rightarrow 0$; in this limit we need then to introduce an infrared regulator mass m_ϵ [32] (which will drop out of the final result)

$$\begin{aligned} \langle m_a | m_b | m_\epsilon, m_\epsilon \rangle = & \frac{\Gamma(1 + 2\epsilon)}{2} \left(\frac{1}{\epsilon^2} + \frac{1 - 2 \log m_\epsilon^2}{\epsilon} + 1 - \frac{\pi^2}{6} - F_2(m_a^2, m_b^2) - 2F_3(m_a^2, m_b^2) \right. \\ & \left. + (-2 + 2F_1(m_a^2, m_b^2)) \log m_\epsilon^2 + \log^2 m_\epsilon^2 \right). \quad (\text{A.9}) \end{aligned}$$

The functions above for $a \neq b$ are defined as [32]

$$\begin{aligned} F_1(a, b) &\equiv \frac{a \log a - b \log b}{a - b}, & F_2(a, b) &\equiv \frac{a \log^2 a - b \log^2 b}{a - b}, \\ F_3(a, b) &\equiv \frac{a \text{Li}_2(1 - \frac{b}{a}) - b \text{Li}_2(1 - \frac{a}{b})}{a - b}, \end{aligned} \quad (\text{A.10})$$

while

$$F_1(a, a) \equiv 1 + \log a, \quad F_2(a, a) \equiv 2 \log a + \log^2 a, \quad F_3(a, a) \equiv 2. \quad (\text{A.11})$$

Note that $h(0, b) = 1 + \text{Li}_2(1 - b)$.

Now we will introduce a formalism such that the integrals can be carried out straightforwardly for any form factor $f(p^2)$. Let us rewrite eq. (A.1) as follows (suppressing here for notational simplicity the indices i, t for the nodes),

$$\begin{aligned} \mathcal{E}(x, \{y_\ell\}) &= \frac{1}{4M^2 x^2} \int \frac{d^4 p d^4 q}{\pi^4} f(p^2) \left[- \frac{2}{p^2 [q^2 + m_+^2] [(p+q)^2 + m_-^2]} \right. \\ &+ \sum_{\pm} \frac{4}{p^2 [q^2 + m_0^2] [(p+q)^2 + m_{\pm}^2]} - \sum_{\pm} \frac{1}{p^2 [q^2 + m_{\pm}^2] [(p+q)^2 + m_{\pm}^2]} \\ &- \frac{4}{p^2 [q^2 + m_0^2] [(p+q)^2 + m_0^2]} + \sum_{\pm} \frac{4(m_{\pm}^2 - m_0^2)}{p^4 [q^2 + m_0^2] [(p+q)^2 + m_{\pm}^2]} \\ &\left. - \sum_{\pm} \frac{4m_{\pm}^2}{p^4 [q^2 + m_{\pm}^2] [(p+q)^2 + m_{\pm}^2]} + \frac{8m_0^2}{p^4 [q^2 + m_0^2] [(p+q)^2 + m_0^2]} \right], \end{aligned} \quad (\text{A.12})$$

where the sum over \pm is understood as the sum over the masses m_+ and m_- . It is easily seen that the terms can be split into two classes. The first comprises the first four terms by having only one massless propagator $1/p^2$, and we will denote this class the α terms, while the second class has two massless propagators $1/p^4$, and correspondingly we will denote this class the β terms. Using the fact that all the form factor functions $f(p^2)$ can be expanded in partial fractions for the α terms as

$$\frac{f(p^2)}{p^2} = \frac{a_0}{p^2} + \sum_{\ell} \frac{a_{1,\ell}}{p^2 + m_{\ell}^2} + \sum_{\ell} \frac{a_{2,\ell}}{(p^2 + m_{\ell}^2)^2}, \quad (\text{A.13})$$

where the sum is over all the mass poles not counting multiplicity, while for the β terms the corresponding partial fractions read

$$\frac{f(p^2)}{p^4} = \frac{b_{-1}}{p^2} + \frac{b_0}{p^4} + \sum_{\ell} \frac{b_{1,\ell}}{p^2 + m_{\ell}^2} + \sum_{\ell} \frac{b_{2,\ell}}{(p^2 + m_{\ell}^2)^2}, \quad (\text{A.14})$$

we can proceed as follows. First, we define the basic functions

$$\begin{aligned}
\alpha_0(x) &\equiv \frac{1}{4M^2} \left(\sum_{\pm} [4\langle 0|m_0|m_{\pm} \rangle - \langle 0|m_{\pm}|m_{\pm} \rangle] - 2\langle 0|m_+|m_- \rangle - 4\langle 0|m_0|m_0 \rangle \right) , \\
\alpha_1(x, y_{\ell}) &\equiv \frac{1}{4M^2} \left(\sum_{\pm} [4\langle m_{\ell}|m_0|m_{\pm} \rangle - \langle m_{\ell}|m_{\pm}|m_{\pm} \rangle] - 2\langle m_{\ell}|m_+|m_- \rangle - 4\langle m_{\ell}|m_0|m_0 \rangle \right) , \\
\alpha_2(x, y_{\ell}) &\equiv \frac{1}{4} \left(\sum_{\pm} [4\langle m_{\ell}, m_{\ell}|m_0|m_{\pm} \rangle - \langle m_{\ell}, m_{\ell}|m_{\pm}|m_{\pm} \rangle] - 2\langle m_{\ell}, m_{\ell}|m_+|m_- \rangle \right. \\
&\quad \left. - 4\langle m_{\ell}, m_{\ell}|m_0|m_0 \rangle \right) , \tag{A.15} \\
\beta_{-1}(x) &\equiv \frac{1}{M^4} \left(\sum_{\pm} [(m_{\pm}^2 - m_0^2) \langle 0|m_0|m_{\pm} \rangle - m_{\pm}^2 \langle 0|m_{\pm}|m_{\pm} \rangle] + 2m_0^2 \langle 0|m_0|m_0 \rangle \right) - r(x) , \\
\beta_0(x) &\equiv \frac{1}{M^2} \left(\sum_{\pm} [(m_{\pm}^2 - m_0^2) \langle 0, 0|m_0|m_{\pm} \rangle - m_{\pm}^2 \langle 0, 0|m_{\pm}|m_{\pm} \rangle] + 2m_0^2 \langle 0, 0|m_0|m_0 \rangle \right) , \\
\beta_1(x, y_{\ell}) &\equiv \frac{1}{M^4} \left(\sum_{\pm} [(m_{\pm}^2 - m_0^2) \langle m_{\ell}|m_0|m_{\pm} \rangle - m_{\pm}^2 \langle m_{\ell}|m_{\pm}|m_{\pm} \rangle] + 2m_0^2 \langle m_{\ell}|m_0|m_0 \rangle \right) - r(x) , \\
\beta_2(x, y_{\ell}) &\equiv \frac{1}{M^2} \left(\sum_{\pm} [(m_{\pm}^2 - m_0^2) \langle m_{\ell}, m_{\ell}|m_0|m_{\pm} \rangle - m_{\pm}^2 \langle m_{\ell}, m_{\ell}|m_{\pm}|m_{\pm} \rangle] \right. \\
&\quad \left. + 2m_0^2 \langle m_{\ell}, m_{\ell}|m_0|m_0 \rangle \right) .
\end{aligned}$$

We have not presented the function $r(x)$ in β_{-1} and β_1 in eq. (A.15), since it must drop out of the final result because of infrared cancellations. Hence, one should check that (see eq. (A.24) below)

$$b_{-1} + \sum_{\ell} b_{1,\ell} = 0 , \tag{A.16}$$

and since $r(x)$ is not a function of y_{ℓ} it will indeed drop out.

Carrying out the integrals yields

$$\alpha_0(x) = -\text{Li}_2(-x) - (1+x)\text{Li}_2\left(\frac{x}{1+x}\right) + \frac{1}{2}(1+x)\text{Li}_2\left(\frac{2x}{1+x}\right) + (x \rightarrow -x) , \tag{A.17}$$

$$\begin{aligned}
\alpha_1(x, y) &= h(y^2, 1) - h(y^2, 1+x) + \frac{y^2}{2} h\left(\frac{1}{y^2}, \frac{1}{y^2}\right) - y^2 h\left(\frac{1+x}{y^2}, \frac{1}{y^2}\right) \\
&\quad + \frac{y^2}{4} h\left(\frac{1+x}{y^2}, \frac{1-x}{y^2}\right) + \frac{y^2}{4} h\left(\frac{1+x}{y^2}, \frac{1+x}{y^2}\right) + \frac{1+x}{2} h\left(\frac{y^2}{1+x}, 1\right) \\
&\quad - (1+x) h\left(\frac{y^2}{1+x}, \frac{1}{1+x}\right) + \frac{1+x}{2} h\left(\frac{y^2}{1+x}, \frac{1-x}{1+x}\right) + (x \rightarrow -x) , \tag{A.18}
\end{aligned}$$

$$\begin{aligned}
\alpha_2(x, y) &= -\frac{1}{2} h\left(\frac{1}{y^2}, \frac{1}{y^2}\right) + h\left(\frac{1+x}{y^2}, \frac{1}{y^2}\right) - \frac{1}{4} h\left(\frac{1+x}{y^2}, \frac{1+x}{y^2}\right) - \frac{1}{4} h\left(\frac{1+x}{y^2}, \frac{1-x}{y^2}\right) \\
&\quad + (x \rightarrow -x) , \tag{A.19}
\end{aligned}$$

$$\beta_{-1}(x) = \frac{x^2}{2} - x\text{Li}_2(-x) - (1+x)x\text{Li}_2\left(\frac{x}{1+x}\right) + (x \rightarrow -x) , \quad (\text{A.20})$$

$$\beta_0(x) = (1+x)\log(1+x) + \text{Li}_2(-x) - (1+x)\text{Li}_2\left(\frac{x}{1+x}\right) + (x \rightarrow -x) , \quad (\text{A.21})$$

$$\begin{aligned} \beta_1(x, y) = & -2h(y^2, 1) - xh(y^2, 1+x) - y^2h\left(\frac{1}{y^2}, \frac{1}{y^2}\right) - xy^2h\left(\frac{1+x}{y^2}, \frac{1}{y^2}\right) \\ & + (1+x)y^2h\left(\frac{1+x}{y^2}, \frac{1+x}{y^2}\right) + 2(1+x)^2h\left(\frac{y^2}{1+x}, 1\right) \\ & - (1+x)xh\left(\frac{y^2}{1+x}, \frac{1}{1+x}\right) - \frac{x^2}{2} + (x \rightarrow -x) , \end{aligned} \quad (\text{A.22})$$

$$\beta_2(x, y) = h\left(\frac{1}{y^2}, \frac{1}{y^2}\right) + xh\left(\frac{1+x}{y^2}, \frac{1}{y^2}\right) - (1+x)h\left(\frac{1+x}{y^2}, \frac{1+x}{y^2}\right) + (x \rightarrow -x) . \quad (\text{A.23})$$

Finally, using these definitions along with the coefficients of the partial fractions defined in eqs. (A.13) and (A.14), we can conveniently write

$$\begin{aligned} \mathcal{E}(x, \{y_\ell\}) = & \frac{1}{x^2} \left(a_0\alpha_0(x) + b_{-1}M^2\beta_{-1}(x) + b_0\beta_0(x) \right. \\ & \left. + \sum_\ell \left[a_{1,\ell}\alpha_1(x, y_\ell) + \frac{a_{2,\ell}}{M^2}\alpha_2(x, y_\ell) + b_{1,\ell}M^2\beta_1(x, y_\ell) + b_{2,\ell}\beta_2(x, y_\ell) \right] \right) , \end{aligned} \quad (\text{A.24})$$

where as already mentioned, the sum is over all the mass poles in $f(p^2)$ not counting multiplicity.

A.1 Example: MGM

As a simple example, we can calculate the suppression function for minimal gauge mediation as follows: $f(p^2) = 1$ implies that the only non-zero coefficients of the partial fractions are $a_0 = b_0 = 1$ and hence the result is [33, 32]

$$\mathcal{E}(x) = \frac{1}{x^2} (\alpha_0(x) + \beta_0(x)) . \quad (\text{A.25})$$

This function approaches 1 for small x , as will be discussed in the next sub-appendix.

A.2 Limits

Let us first consider the limit $x \rightarrow 0$, which corresponds to the messenger scale being much larger than the SUSY-breaking scale: $M \gg \sqrt{F}$. It is also motivated by the fact that the soft masses do not vary much for $x \lesssim 0.7$, and hence it is a good approximation for a large range. Since all the functions are even in x and they are all multiplied by $1/x^2$, the only term we need to calculate is that of order x^2 in the Taylor expansion. For the α class functions we get

$$\lim_{x \rightarrow 0} \frac{\alpha_0(x)}{x^2} = \lim_{x \rightarrow 0} \frac{\alpha_1(x, y)}{x^2} = \lim_{x \rightarrow 0} \frac{\alpha_2(x, y)}{x^2} = 0 , \quad (\text{A.26})$$

while for the β class functions we obtain

$$\lim_{x \rightarrow 0} \frac{\beta_{-1}(x)}{x^2} = \lim_{x \rightarrow 0} \frac{\beta_0(x)}{x^2} = 1 , \quad (\text{A.27})$$

$$\begin{aligned} \tilde{\beta}_1(y) \equiv \lim_{x \rightarrow 0} \frac{\beta_1(x, y)}{x^2} &= -1 + 2h(y^2, 1) - 2\iota(y^2, 1, y^2, 0) + 2y^2\iota\left(\frac{1}{y^2}, \frac{1}{y^2}, \frac{1}{y^2}, 0\right) \\ &\quad + y^2\sigma\left(\frac{1}{y^2}, \frac{1}{y^2}, \frac{1}{y^2}, \frac{1}{y^2}\right) + 2\sigma(y^2, 1, y^2, 0) , \end{aligned} \quad (\text{A.28})$$

$$\tilde{\beta}_2(y) \equiv \lim_{x \rightarrow 0} \frac{\beta_2(x, y)}{x^2} = -2\iota\left(\frac{1}{y^2}, \frac{1}{y^2}, \frac{1}{y^2}, 0\right) - \sigma\left(\frac{1}{y^2}, \frac{1}{y^2}, \frac{1}{y^2}, \frac{1}{y^2}\right) , \quad (\text{A.29})$$

where we have defined the following functions

$$\begin{aligned} \iota(a, b, c, d) &\equiv - \int_0^1 \frac{dt}{1-\mu^2} \left(1 + \frac{\mu^2}{1-\mu^2} \log \mu^2\right) \nu , \quad \mu^2 \equiv \frac{a}{1-t} + \frac{b}{t} , \quad \nu \equiv \frac{c}{1-t} + \frac{d}{t} , \\ \sigma(a, b, c, d) &\equiv - \int_0^1 \frac{dt}{(1-\mu^2)^2} \left(2 + \frac{1+\mu^2}{1-\mu^2} \log \mu^2\right) \nu^2 , \end{aligned} \quad (\text{A.30})$$

and the expansion of the function $h(a(x), b(x))$ is made as follows

$$\begin{aligned} h(a(x), b(x)) &= h(a(0), b(0)) + \iota(a(0), b(0), a'(0), b'(0)) x \\ &\quad + \frac{1}{2}\sigma(a(0), b(0), a'(0), b'(0)) x^2 + \frac{1}{2}\iota(a(0), b(0), a''(0), b''(0)) x^2 + \mathcal{O}(x^3) , \end{aligned} \quad (\text{A.31})$$

where $a'(x) = da(x)/dx$, etc.

There is another limit, which merely serves as a check of the calculations, i.e. taking all y 's to infinity. Using that

$$\lim_{y \rightarrow \infty} h(ay^2, X) = 1 + \text{Li}_2(-ay^2) , \quad (\text{A.32})$$

$$h\left(\frac{a}{y^2}, \frac{b}{y^2}\right) = 1 + \frac{\pi^2}{6} - \frac{a+b}{y^2} (1 + \log y^2) + \frac{a}{y^2} \log a + \frac{b}{y^2} \log b + \mathcal{O}(y^{-4}) , \quad (\text{A.33})$$

we find that

$$\lim_{y \rightarrow \infty} \alpha_1(x, y) = \lim_{y \rightarrow \infty} y^2 \alpha_2(x, y) = \lim_{y \rightarrow \infty} \frac{\beta_{-1}(x)}{y^2} = \lim_{y \rightarrow \infty} \frac{\beta_1(x, y)}{y^2} = \lim_{y \rightarrow \infty} \beta_2(x, y) = 0 , \quad (\text{A.34})$$

where the factors of y^2 multiplying the functions are always present for dimensional reasons. Then it is easy to see that any mass factor reduces to

$$\mathcal{E}(x, \infty) = \frac{1}{x^2} (a_0 \alpha_0(x) + b_0 \beta_0(x)) . \quad (\text{A.35})$$

Hence, if $a_0 = b_0 = 1$ the result reduces to that of MGM. This is indeed the case for all the masses calculated in this note (independent of which node the field is charged under).

A final limit, which is a bit harder to calculate, is the limit of $y \rightarrow 0$. This limit serves only as a consistency check and hence we will not give all the details. The result after the dust has settled is

$$\lim_{y \rightarrow 0} \alpha_1(x, y) = \alpha_0(x) , \quad \lim_{y \rightarrow 0} y^2 \alpha_2(x, y) = 0 , \quad \lim_{y \rightarrow 0} \beta_2(x, y) = \beta_0(x) , \quad (\text{A.36})$$

while expanding we find

$$\beta_1(x, y) = \beta_{-1}(x) - y^2 \beta_0(x) + \mathcal{O}(y^3) . \quad (\text{A.37})$$

Thus eq. (A.24) simplifies in this limit as follows

$$\mathcal{E}(x, 0) = \frac{1}{x^2} \left[\left(a_0 + \sum_{\ell} a_{1,\ell} \right) \alpha_0(x) + \left(b_0 + \sum_{\ell} (b_{2,\ell} - \tilde{b}_{1,\ell}) \right) \beta_0(x) \right] , \quad (\text{A.38})$$

where we have defined $\tilde{b}_{1,\ell} \equiv \lim_{y_{\ell} \rightarrow 0} M^2 y_{\ell}^2 b_{1,\ell}$. This result is after all expected and one can check that the formula gives zero for all nodes which are not connected to the messengers while it gives the MGM result (A.25) multiplied by g_i^4/g_{eff}^4 with i being the node under consideration.

References

- [1] A. De Simone, J. Fan, M. Schmaltz, W. Skiba, “Low-scale gaugino mediation, lots of leptons at the LHC,” *Phys. Rev.* **D78**, 095010 (2008). [arXiv:0808.2052 [hep-ph]].
- [2] A. De Simone, J. Fan, V. Sanz, W. Skiba, “Leptogenic Supersymmetry,” *Phys. Rev.* **D80**, 035010 (2009). [arXiv:0903.5305 [hep-ph]].
- [3] D. Green, A. Katz and Z. Komargodski, “Direct Gaugino Mediation,” *Phys. Rev. Lett.* **106**, 061801 (2011) [arXiv:1008.2215 [hep-th]].
- [4] Z. Komargodski, D. Shih, “Notes on SUSY and R-Symmetry Breaking in Wess-Zumino Models,” *JHEP* **0904**, 093 (2009). [arXiv:0902.0030 [hep-th]].
- [5] N. Craig, D. Green, A. Katz, “(De)Constructing a Natural and Flavorful Supersymmetric Standard Model,” *JHEP* **1107**, 045 (2011). [arXiv:1103.3708 [hep-ph]].
- [6] N. Arkani-Hamed, A. G. Cohen, H. Georgi, “(De)constructing dimensions,” *Phys. Rev. Lett.* **86**, 4757-4761 (2001). [hep-th/0104005].
- [7] D. E. Kaplan, G. D. Kribs and M. Schmaltz, “Supersymmetry breaking through transparent extra dimensions,” *Phys. Rev. D* **62**, 035010 (2000) [arXiv:hep-ph/9911293].
- [8] Z. Chacko, M. A. Luty, A. E. Nelson and E. Ponton, “Gaugino mediated supersymmetry breaking,” *JHEP* **0001**, 003 (2000) [arXiv:hep-ph/9911323].
- [9] C. Csaki, J. Erlich, C. Grojean and G. D. Kribs, “4-D constructions of supersymmetric extra dimensions and gaugino mediation,” *Phys. Rev. D* **65**, 015003 (2002) [arXiv:hep-ph/0106044].
- [10] H. C. Cheng, D. E. Kaplan, M. Schmaltz, W. Skiba, “Deconstructing gaugino mediation,” *Phys. Lett.* **B515**, 395-399 (2001). [hep-ph/0106098].

- [11] R. Auzzi, A. Giveon, “The Sparticle spectrum in Minimal gaugino-Gauge Mediation,” *JHEP* **1010**, 088 (2010). [arXiv:1009.1714 [hep-ph]].
- [12] R. Auzzi, A. Giveon, “Superpartner spectrum of minimal gaugino-gauge mediation,” *JHEP* **1101**, 003 (2011). [arXiv:1011.1664 [hep-ph]].
- [13] R. Auzzi, A. Giveon, S. B. Gudnason, T. Shacham, “On the Spectrum of Direct Gaugino Mediation,” [arXiv:1107.1414 [hep-ph]].
- [14] P. Meade, N. Seiberg and D. Shih, “General Gauge Mediation,” *Prog. Theor. Phys. Suppl.* **177**, 143 (2009) [arXiv:0801.3278 [hep-ph]].
- [15] M. Buican, P. Meade, N. Seiberg and D. Shih, “Exploring General Gauge Mediation,” *JHEP* **0903**, 016 (2009) [arXiv:0812.3668 [hep-ph]].
- [16] D. Marques, “Generalized messenger sector for gauge mediation of supersymmetry breaking and the soft spectrum,” *JHEP* **0903**, 038 (2009) [arXiv:0901.1326 [hep-ph]].
- [17] T. T. Dumitrescu, Z. Komargodski, N. Seiberg and D. Shih, “General Messenger Gauge Mediation,” *JHEP* **1005**, 096 (2010) [arXiv:1003.2661 [hep-ph]].
- [18] K. Benakli, M. D. Goodsell, “Dirac Gauginos in General Gauge Mediation,” *Nucl. Phys.* **B816** (2009) 185-203. [arXiv:0811.4409 [hep-ph]].
- [19] S. Abel, M. Goodsell, “Easy Dirac Gauginos,” *JHEP* **1106** (2011) 064. [arXiv:1102.0014 [hep-th]].
- [20] M. McGarrie, “General Gauge Mediation and Deconstruction,” *JHEP* **1011**, 152 (2010) [arXiv:1009.0012 [hep-ph]]; M. McGarrie, “Hybrid Gauge Mediation,” [arXiv:1101.5158 [hep-ph]].
- [21] M. Sudano, “General Gaugino Mediation,” arXiv:1009.2086 [hep-ph].
- [22] C. T. Hill, S. Pokorski, J. Wang, “Gauge invariant effective Lagrangian for Kaluza-Klein modes,” *Phys. Rev.* **D64** (2001) 105005. [hep-th/0104035].
- [23] H. -C. Cheng, C. T. Hill, S. Pokorski, J. Wang, “The Standard model in the latticized bulk,” *Phys. Rev.* **D64** (2001) 065007. [hep-th/0104179].
- [24] E. A. Mirabelli, M. E. Peskin, “Transmission of supersymmetry breaking from a four-dimensional boundary,” *Phys. Rev.* **D58** (1998) 065002. [hep-th/9712214].
- [25] M. McGarrie, R. Russo, “General Gauge Mediation in 5D,” *Phys. Rev.* **D82** (2010) 035001. [arXiv:1004.3305 [hep-ph]].
- [26] P. Batra, A. Delgado, D. E. Kaplan, T. M. P. Tait, “The Higgs mass bound in gauge extensions of the minimal supersymmetric standard model,” *JHEP* **0402** (2004) 043. [arXiv:hep-ph/0309149 [hep-ph]].
- [27] A. Maloney, A. Pierce, J. G. Wacker, “D-terms, unification, and the Higgs mass,” *JHEP* **0606** (2006) 034. [hep-ph/0409127].
- [28] N. Arkani-Hamed, A. G. Cohen, H. Georgi, “Accelerated unification,” [hep-th/0108089].
- [29] R. Barbieri, G. Isidori, J. Jones-Perez, P. Lodone, D. M. Straub, “U(2) and Minimal Flavour Violation in Supersymmetry,” *Eur. Phys. J.* **C71**, 1725 (2011). [arXiv:1105.2296 [hep-ph]].
- [30] J. van der Bij and M. J. G. Veltman, “Two Loop Large Higgs Mass Correction to the rho

Parameter,” Nucl. Phys. B **231**, 205 (1984).

- [31] A. Ghinculov and J. J. van der Bij, “Massive two loop diagrams: The Higgs propagator,” Nucl. Phys. B **436**, 30 (1995) [arXiv:hep-ph/9405418].
- [32] S. P. Martin, “Generalized messengers of supersymmetry breaking and the sparticle mass spectrum,” Phys. Rev. D **55**, 3177 (1997) [arXiv:hep-ph/9608224].
- [33] S. Dimopoulos, G. F. Giudice and A. Pomarol, “Dark matter in theories of gauge mediated supersymmetry breaking,” Phys. Lett. B **389**, 37 (1996) [arXiv:hep-ph/9607225].

	a_0	$a_{1,1}$	$a_{1,2}$	$a_{1,3}$	$\frac{a_{2,1}}{M^2}$	$\frac{a_{2,2}}{M^2}$	$\frac{a_{2,3}}{M^2}$	$b_{-1}M^2$	b_0	$b_{1,1}M^2$	$b_{1,2}M^2$	$b_{1,3}M^2$	$b_{2,1}$	$b_{2,2}$	$b_{2,3}$
\mathcal{E}_1^4	1	$\frac{1}{\sqrt{2}}$	-1	$-\frac{1}{\sqrt{2}}$	$-\frac{1}{2}y_2^2$	$-y_2^2$	$-\frac{1}{2}y_1^2$	$-\frac{10}{y_2^2}$	1	$\frac{8+5\sqrt{2}}{2y_2^2}$	$\frac{2}{y_2^2}$	$\frac{8-5\sqrt{2}}{2y_2^2}$	$\frac{3}{2} + \sqrt{2}$	1	$\frac{3}{2} - \sqrt{2}$
\mathcal{E}_2^4	1	$-2 + \frac{1}{\sqrt{2}}$	3	$-2 - \frac{1}{\sqrt{2}}$	$-\frac{1}{2}y_1^2$	$-y_2^2$	$-\frac{1}{2}y_3^2$	$-\frac{6}{y_2^2}$	1	$\frac{8+3\sqrt{2}}{2y_2^2}$	$-\frac{2}{y_2^2}$	$\frac{8-3\sqrt{2}}{2y_2^2}$	$\frac{1}{2}$	1	$\frac{1}{2}$
\mathcal{E}_3^4	1	$2 + \frac{1}{\sqrt{2}}$	-5	$2 - \frac{1}{\sqrt{2}}$	$-\frac{1}{2}y_1^2$	$-y_2^2$	$-\frac{1}{2}y_3^2$	$\frac{2}{y_2^2}$	1	$-\frac{8+5\sqrt{2}}{2y_2^2}$	$\frac{6}{y_2^2}$	$-\frac{8-5\sqrt{2}}{2y_2^2}$	$\frac{1}{2}$	1	$\frac{1}{2}$
\mathcal{E}_4^4	1	$4 + \frac{1}{\sqrt{2}}$	7	$4 - \frac{1}{\sqrt{2}}$	$-\frac{1}{2}y_3^2$	$-y_2^2$	$-\frac{1}{2}y_1^2$	$\frac{14}{y_2^2}$	1	$-\frac{8+3\sqrt{2}}{2y_2^2}$	$-\frac{6}{y_2^2}$	$-\frac{8-3\sqrt{2}}{2y_2^2}$	$\frac{3}{2} + \sqrt{2}$	1	$\frac{3}{2} - \sqrt{2}$

Table 1. Coefficients in the suppression functions for the linear quiver with $N = 4$, shown in fig. 7, with equal couplings and equal VEVs. The suppression functions are given in eq. (A.24).

	a_0	$a_{1,1}$	$a_{1,2}$	$a_{1,3}$	$a_{1,4}$	$\frac{a_{2,1}}{M^2}$	$\frac{a_{2,2}}{M^2}$	$\frac{a_{2,3}}{M^2}$	$\frac{a_{2,4}}{M^2}$
\mathcal{E}_1^5	1	$\frac{\sqrt{5}}{2}$	$-\frac{1}{2}$	$-\frac{\sqrt{5}}{2}$	$-\frac{1}{2}$	$-\frac{5(3+\sqrt{5})y_1^2}{8}$	$-\frac{(25+11\sqrt{5})y_1^2}{8}$	$-\frac{5(3+\sqrt{5})y_1^2}{8}$	$-\frac{(5-\sqrt{5})y_1^2}{8}$
\mathcal{E}_2^5	1	$-\frac{\sqrt{5}}{2}$	$-\frac{1}{2} + \sqrt{5}$	$\frac{\sqrt{5}}{2}$	$-\frac{1}{2} - \sqrt{5}$	$-\frac{5y_1^2}{4}$	$-\frac{(5+\sqrt{5})y_1^2}{8}$	$-\frac{5(7+3\sqrt{5})y_1^2}{8}$	$-\frac{(5+2\sqrt{5})y_1^2}{8}$
\mathcal{E}_3^5	1	0	$-\frac{1-\sqrt{5}}{2}$	0	$-\frac{1+\sqrt{5}}{2}$	0	$-(5+2\sqrt{5})y_1^2$	0	$-\frac{(5+\sqrt{5})y_1^2}{2}$
\mathcal{E}_4^5	1	$2\sqrt{5}$	$-\frac{1+3\sqrt{5}}{2}$	$-2\sqrt{5}$	$-\frac{1-3\sqrt{5}}{2}$	$-\frac{5y_1^2}{4}$	$-\frac{(5+\sqrt{5})y_1^2}{8}$	$-\frac{5(7+3\sqrt{5})y_1^2}{8}$	$-\frac{(5+2\sqrt{5})y_1^2}{4}$
\mathcal{E}_5^5	1	$\frac{25-3\sqrt{5}}{4}$	$\frac{23+5\sqrt{5}}{4}$	$\frac{25+3\sqrt{5}}{4}$	$\frac{23-5\sqrt{5}}{4}$	$-\frac{5(3+\sqrt{5})y_1^2}{8}$	$-\frac{(25+11\sqrt{5})y_1^2}{8}$	$-\frac{5(3+\sqrt{5})y_1^2}{8}$	$-\frac{(5-\sqrt{5})y_1^2}{8}$

Table 2. Coefficients of α type in the suppression functions for the linear quiver with $N = 5$, shown in fig. 7, with equal couplings and equal VEVs. The suppression functions are given in eq. (A.24).

	$b_{-1}M^2$	b_0	$b_{1,1}M^2$	$b_{1,2}M^2$	$b_{1,3}M^2$	$b_{1,4}M^2$	$b_{2,1}$	$b_{2,2}$	$b_{2,3}$	$b_{2,4}$
\mathcal{E}_1^5	$-\frac{4(3-\sqrt{5})}{y_1^2}$	1	$\frac{15+\sqrt{5}}{8y_1^2}$	$\frac{10+\sqrt{5}}{20y_1^2}$	$\frac{30-13\sqrt{5}}{4y_1^2}$	$\frac{85-37\sqrt{5}}{40y_1^2}$	$\frac{5(3+\sqrt{5})}{8}$	$\frac{7+3\sqrt{5}}{8}$	$\frac{5(3-\sqrt{5})}{8}$	$\frac{7-3\sqrt{5}}{8}$
\mathcal{E}_2^5	$-\frac{3(3-\sqrt{5})}{y_1^2}$	1	$\frac{5+2\sqrt{5}}{4y_1^2}$	$\frac{35-23\sqrt{5}}{40y_1^2}$	$\frac{65-29\sqrt{5}}{8y_1^2}$	$-\frac{25-14\sqrt{5}}{20y_1^2}$	$\frac{5}{4}$	$\frac{1}{4}$	$\frac{5}{4}$	$\frac{1}{4}$
\mathcal{E}_3^5	$-\frac{3-\sqrt{5}}{y_1^2}$	1	0	$\frac{5-\sqrt{5}}{5y_1^2}$	0	$\frac{2-\sqrt{5}}{y_1^2}$	0	$\frac{3+\sqrt{5}}{2}$	0	$\frac{3-\sqrt{5}}{2}$
\mathcal{E}_4^5	$\frac{6-2\sqrt{5}}{y_1^2}$	1	$\frac{5-8\sqrt{5}}{4y_1^2}$	$-\frac{3(5-9\sqrt{5})}{40y_1^2}$	$-\frac{85-41\sqrt{5}}{8y_1^2}$	$\frac{75-36\sqrt{5}}{20y_1^2}$	$\frac{5}{4}$	$\frac{1}{4}$	$\frac{5}{4}$	$\frac{1}{4}$
\mathcal{E}_5^5	$\frac{6(3-\sqrt{5})}{y_1^2}$	1	$-\frac{35-11\sqrt{5}}{8y_1^2}$	$-\frac{40-\sqrt{5}}{20y_1^2}$	$-\frac{20-7\sqrt{5}}{4y_1^2}$	$-\frac{265-113\sqrt{5}}{40y_1^2}$	$\frac{5(3+\sqrt{5})}{8}$	$\frac{7+3\sqrt{5}}{8}$	$\frac{5(3-\sqrt{5})}{8}$	$\frac{7-3\sqrt{5}}{8}$

Table 3. Coefficients of β type in the suppression functions for the linear quiver with $N = 5$, shown in fig. 7, with equal couplings and equal VEVs. The suppression functions are given in eq. (A.24).