

ABSTRACT. These lecture notes are based on [arXiv: math/0702714, 0907.4469, 0907.4470]. We introduce and study basic aspects of non-Euclidean geometries from a coordinate-free viewpoint.

# Basic coordinate-free non-Euclidean geometry

SASHA ANAN'IN AND CARLOS H. GROSSI

<b>1. Darwin and geometry</b>	3
1.1. Risks of travelling around the world	3
1.2. Question	4
1.3. Cogito, ergo sum	4
1.4. Guide to the reader	4
<b>2. Projective spaces and their relatives</b>	5
2.1. Problem	5
2.6. Projective space	7
2.7. Sphere and stereographic projection	8
2.9. Riemann sphere	9
2.12A. Grassmannians	9
<b>3. Smooth spaces and smooth functions</b>	9
3.1. Introductory remarks	10
3.2. Sheaves of functions	10
3.3. Basic example	10
3.4. Smooth maps and induced structures	11
3.5. Product and fibre bundle	12
3.5.1. Product	12
3.5.5. Fibre product	12
3.6. Tangent bundle	13
3.6.1. Tangent vectors	13
3.6.3. Differential	13
3.6.5. Tangent bundle of a subspace	14
3.6.8. Equations	14
3.6.10. Taylor sheaves	15
3.6.11. Prevarieties	16
3.7. $C^\infty$ -manifolds	18
3.7.2. Families and bundles	18
3.7.8. Tangent vector to a curve	18
3.8A. Final remarks	19
<b>4. Elementary geometry</b>	19
4.1. Some notation	19
4.2. Tangent space	20
4.3. Metric	20
4.3.2. Length and angle	21
4.4. Examples	21
4.5. Geodesics and tance	22
4.5.4. Spherical geodesics	22
4.5.6. Hyperbolic geodesics	23
4.5.7. Triangle inequality	23
4.5.8. Duality	24
4.6. Space of circles	24

4.7. Complex hyperbolic zoo	25
4.8. Finite configurations	25
4.8.1. Stollen Carlos' lemma	26
4.9. There is no sin south of the equator	27
4.10A. Geometry on the absolute	28
4.11. A bit of history	29
4.11.1. References	30
<b>5. Riemann surfaces</b>	30
5.1. Regular covering and fundamental group	30
5.2. Discrete groups and Poincaré polygonal theorem	30
5.3. Teichmüller space	30
<b>6. Appendix: Largo al factotum della citta</b>	31
6.15. Gram-Schmidt orthogonalization	32
6.20. Sylvester's law of inertia	33
6.21. Sylvester criterion	34
<b>7. Appendix: Basic algebra and topology</b>	35
<b>8. Appendix: Classification of compact surfaces</b>	35
<b>9A. Appendix: Riemannian geometry</b>	35
<b>10A. Appendix: Hyperelliptic surfaces and Goldman's theorem</b>	35
<b>Hints</b>	36
1.2.	36
2.3.	36
2.5.	36
2.10.	36
2.11.	36
3.3.2.	36
3.3.3.	36
3.3.4.	36
3.6.6.	36
4.3.3.	36
4.4.1.	36
4.5.2.	36
4.5.9.	36
4.8.2.	37
6.5.	37
6.6.	37
6.7.	37
6.9.	37
6.10.	37
6.23.	37
6.24.	37
6.25.	37

# Basic coordinate-free non-Euclidean geometry

SASHA ANAN'IN AND CARLOS H. GROSSI

*The introduction of numbers as coordinates . . . is an act of violence . . .*

— HERMANN WEYL, *Philosophy of Mathematics and Natural Science*

*'You see, the earth takes twenty-four hours to turn round on its axis—'  
'Talking of axes,' said the Duchess, 'chop off her head!'*

— LEWIS CARROLL, *Alice's Adventures in Wonderland*

## 1. Darwin and geometry

The subject of this course is deeply related to three great geometers: Riemann, Klein, and Poincaré. With the study of the spherical and hyperbolic plane geometries,<sup>1</sup> we try to achieve the modest purpose of illustrating some contributions of these geometers. On the way, we encounter a few tools discovered in recent years.

Human geometric intuition is considerably stronger than the algebraic one for an obvious reason: since the Stone Age, we have lots of experience in space moving and very few in counting.<sup>2</sup>

The plane geometries have a strong influence in modern geometry which can be partially explained on a biological basis. Birds are certainly excellent geometers: it suffices to see how they express their (probable) happiness with sophisticated pirouettes in three dimensions when the rain is over. Serpents ought to be good topologists. (Soon, we will study a little bit of topology.) Unfortunately, the experience of human beings is nearly two-dimensional, at most 2.5-dimensional. Believers in Darwin's theory might have inherited the three-dimensional experience from the apes but we doubt that this theory<sup>3</sup> actually works: we have never seen an ape turning into a man and are tired of seeing how it goes the other way around. Hence, in order to be well armed for our future, it is essential to study geometry. (See as an illustration the webpage <http://www.ihes.fr/~gromov> of one of the greatest geometers of our days, Misha Gromov.)

**1.1. Risks of travelling around the world.** In three dimensions, a human being usually possesses two legs. This seems to be enough, although we would fall less frequently if they were three. Therefore, in a two-dimensional world, one leg should suffice. Say, the right one.

In the best of all possible two-dimensional worlds, Candid, a son of a cheerful mother, decided to pursue a most challenging adventure, to travel around the world. Fearing the dangers of the voyage, the mother gave her son a sophisticated cell phone capable of sending images and asked him to continuously transmit her a video of the journey. When the trip ended, what a misfortune! A left legged creature returned sweet home!

<sup>1</sup>It turns out that Euclidean geometry is degenerate and somehow separates the other two.

<sup>2</sup>It was common for a Neolithic man to keep hunting new wives, not remembering how many were already in his cave. The uprise of monogamy as a solution to this problem shows the difficulties with arithmetics at those ages.

<sup>3</sup>As a believer in evolutionism and its new branches, Carlos does not share this view. Nevertheless, he is surprised with having difficulties in combinatorics in spite of his microbiological past.

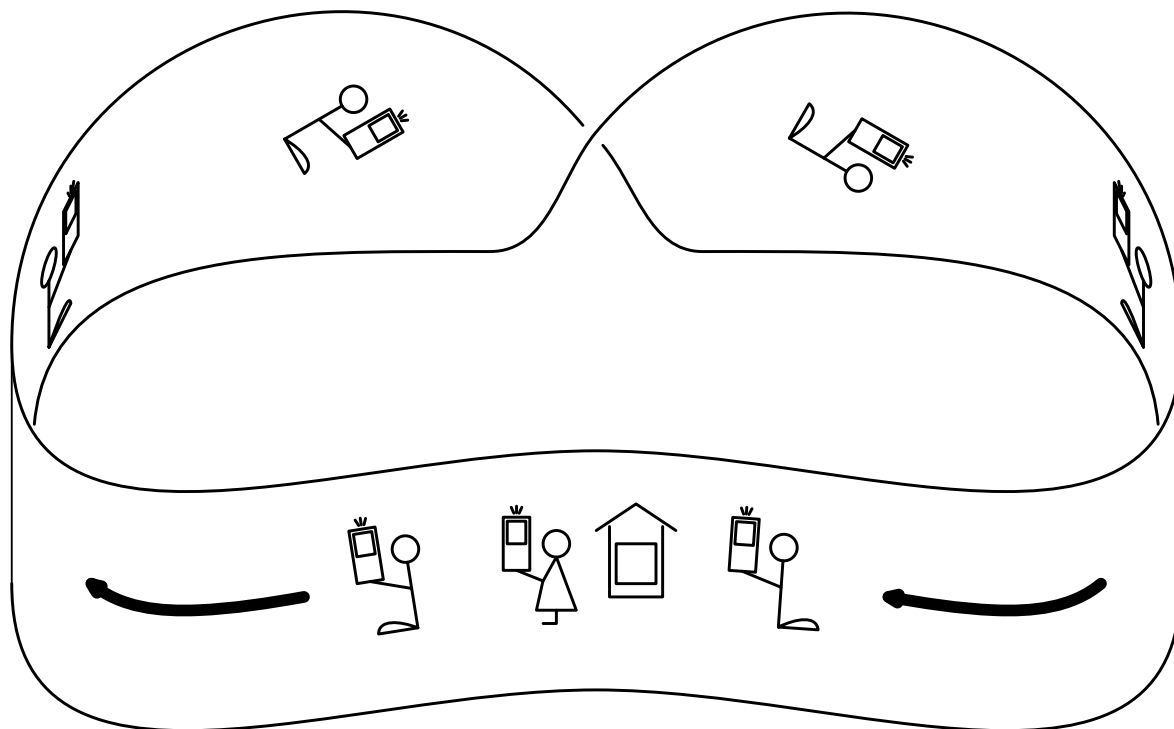

- Where is my beloved son? — asked the desperate mother.
- And most important ... where can I buy him a shoe now?

Clearly, the last question is merely a Customs and Excise one and can be solved through an adequate import/export system. More interesting would be the

**1.2. Question.** At what moment did Candid change his leg?

**1.3. Cogito, ergo sum.** The cartesian coordinates were named after the French mathematician René Descartes. It seems, however, that Descartes is not to be blamed for disseminating the usage of coordinates in science. More likely, it was Gottfried Leibniz, one of Calculus' fathers, the guilty one. Probably, Leibniz also attributed the name 'cartesian coordinates.'

Nobody sees coordinates in Nature. There are no preferred directions either. (Be careful to apply these ideas in traffic.) In spite of looking trivial, the above claim has relatively deep consequences. The conservation of linear momentum is an example: since there is no preferred direction, a particle at rest (with respect to some inertial frame of reference) cannot move spontaneously. In fact, most conservation laws in physics have a similar origin.<sup>4</sup>

The choice of coordinates while addressing a given problem is frequently a typical example of an *arbitrary choice*. It is not difficult to realize that an arbitrary choice adds an extra complexity to the problem. Even worse, such a choice is an obstacle to the understanding, usually hides subtle features of the problem, and obscures the essence of the matter.

Every time we are capable of, we are going to avoid arbitrary choices (of any nature). When an object is essentially related to an arbitrary choice, we say that it 'does not exist.'

**1.4. Guide to the reader.** In what follows, the reader is supposed either to solve all exercises or to skip (some of) them and accept the corresponding claims. We have left many hints along the text.

---

<sup>4</sup>A rigorous version of this statement involves the study of symmetries of differential equations and of the associated conservation laws. Such a theory was discovered by Emmy Noether, a woman mathematician born in the city of Erlangen.

There is also a section entitled ‘Hints’ at the very end. The reader is welcome to use it from time to time — once an exercise is solved, one should look at the corresponding hint anyway. Along the exposition, we use the exercises as if they were solved.

Some subsections in the book are more advanced and, in principle, may be not quite ‘undergraduate.’ We believe that the difficulties an undergraduate student could face in such subsections might be more of psychological nature than caused by a lack of prerequisites. Anyway, the more ‘advanced’ subsections are marked with **A**; skipping them should not compromise the part aimed at undergraduate students.

The book concludes with appendices. They either contain simple and well-known material (sometimes, in a new exposition) used in the book or are marked with **A**. Their only common feature is that they are well inflamed.

## 2. Projective spaces and their relatives

In the Euclidean plane  $\mathbb{E}^2$ , we fix a point  $f$  and consider all lines passing through  $f$ . Such lines constitute points in the space  $\mathbb{P}_{\mathbb{R}}^1$  called the *real projective line*. Intuitively,  $\mathbb{P}_{\mathbb{R}}^1$  is one-dimensional. In order to visualize this space, choose a circle  $\mathbb{S}^1 \subset \mathbb{E}^2$  centred at  $f$ . The circle ‘lists’ the lines passing through  $f$ : every point  $p$  in the circle generates the line joining  $p$  and  $f$ . Clearly, every line (that is, every point in  $\mathbb{P}_{\mathbb{R}}^1$ ) is listed exactly twice, by a pair of diametrically opposed points in the circle. We can therefore visualize the real projective line as being a ‘folded’ circle. In this way, we understand that  $\mathbb{P}_{\mathbb{R}}^1$  is a circle itself. The circle  $\mathbb{P}_{\mathbb{R}}^1$  can also be obtained from any half circle contained in  $\mathbb{S}^1$  by simply gluing the ends of the half circle.

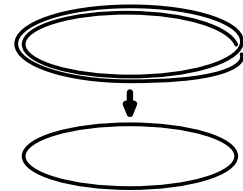

There is another way to visualize  $\mathbb{P}_{\mathbb{R}}^1$ . We arbitrarily choose a point in  $\mathbb{P}_{\mathbb{R}}^1$  and denote it by  $\infty$ . This point corresponds to a line  $R_0$  that passes through  $f$ ,  $f \in R_0 \subset \mathbb{E}^2$ . We choose a line  $T \not\parallel f$ , parallel to  $R_0$ , that does not pass through  $f$ . The line  $T$  will be called the *screen*. Every point  $r \in \mathbb{P}_{\mathbb{R}}^1$  (that is, every line  $R$ ,  $f \in R \subset \mathbb{E}^2$ ), except of  $\infty$ , is displayed on the screen as the intersection point  $R \cap T$ . In this way, the real projective line is a usual line plus an extra point:  $\mathbb{P}_{\mathbb{R}}^1 = \mathbb{E}^1 \sqcup \{\infty\}$ , where  $\mathbb{E}^1 = T$ . We emphasize again that, *a priori*, any point in  $\mathbb{P}_{\mathbb{R}}^1$  may play the role of  $\infty$ .

**2.1. Problem.** Let  $R$  be a line in the Euclidean plane  $\mathbb{E}^2$  and let  $p$  be a point such that  $R \not\parallel p \in \mathbb{E}^2$ . Is it possible, using only a ruler, to construct the line  $R'$  passing through  $p$  and parallel to  $R$ ?

In order to solve Problem 2.1, we need to analyze the concept of ‘parallelism’ and to discover a ‘new’ mathematical object.

In the Euclidean plane, two distinct lines almost always intersect in a point. The only exception occurs when the lines are parallel. It would be nice<sup>5</sup> if the rule could admit no exception . . .

By analogy to the real projective line, we will construct the real projective plane. In the Euclidean 3-dimensional space  $\mathbb{E}^3$ , we fix a point  $f$  (the light source). The *real projective plane* is the set  $\mathbb{P}_{\mathbb{R}}^2$  of all lines passing through  $f$ .

**2.2. Definition.** Let  $f \in P \subset \mathbb{E}^3$  be a plane in  $\mathbb{E}^3$  passing through  $f$ . The set  $\{R \mid f \in R \subset P\}$  of all lines  $R$  in  $P$  passing through  $f$  is said to be a *line* in  $\mathbb{P}_{\mathbb{R}}^2$  (*related to P*). Obviously, this set is some sort of real projective line  $\mathbb{P}_{\mathbb{R}}^1$ .

Given two distinct points  $r_1, r_2 \in \mathbb{P}_{\mathbb{R}}^2$ ,  $r_1 \neq r_2$ , we denote by  $R_1, R_2 \subset \mathbb{E}^3$  the corresponding lines in  $\mathbb{E}^3$ . So, there exists a single line in  $\mathbb{P}_{\mathbb{R}}^2$  that ‘joins’  $r_1$  and  $r_2$ : the plane  $P$  related to the line in question is the one determined by  $R_1, R_2 \subset P$ . Two distinct lines in  $\mathbb{P}_{\mathbb{R}}^2$  intersect in a single point because the intersection of two distinct planes that contain  $f$  is a line in  $\mathbb{E}^3$  passing through  $f$ .

<sup>5</sup>Cicero would say *exceptio probat regulam in casibus non exceptis*, which reads mathematically as ‘a couple of counterexamples can substitute a proof of a theorem.’ According to Ivan Karamazov (‘The Karamazov brothers’ by Fyodor Dostoyevsky) ‘. . . they even dare to dream that two parallel lines . . . may meet somewhere in infinity . . . even if parallel lines do meet and I see it myself, I shall see it and say that they’ve met, but still I won’t accept it.’

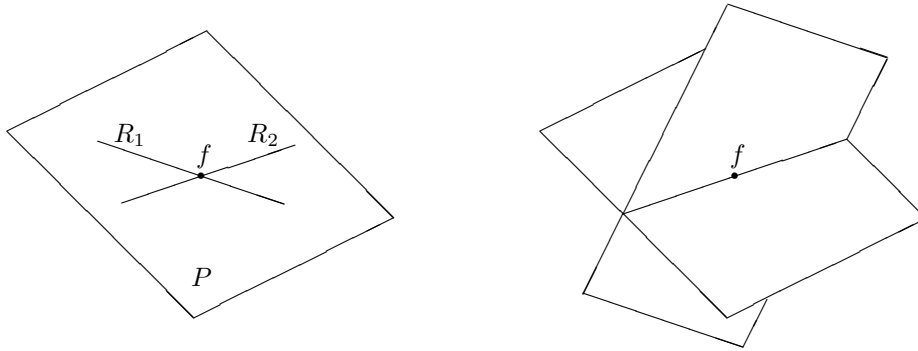

We will show that the Euclidean plane  $\mathbb{E}^2$  can be seen as a part of the projective plane  $\mathbb{P}_{\mathbb{R}}^2$  in such a way that the lines in both planes are the ‘same.’

Indeed, let  $f \notin T \subset \mathbb{E}^3$  be a plane that does not pass through  $f$ . Interpreting  $f$  as a light source and  $T$  as a screen, we can identify almost every point  $r \in \mathbb{P}_{\mathbb{R}}^2$  with its shadow  $p$  on the screen, that is, with the intersection  $T \cap R = \{p\}$  of the screen  $T$  with the corresponding line  $R \subset \mathbb{E}^3$ . Which points do not leave a shadow on the screen? Denoting by  $P_0$  the plane that passes through  $f$  and is parallel to the screen  $T$ ,  $f \in P_0 \subset \mathbb{E}^3$ , we can see that the points that do not have a shadow on the screen form the line  $L_0 \simeq \mathbb{P}_{\mathbb{R}}^1$  in  $\mathbb{P}_{\mathbb{R}}^2$  related to  $P_0$ . In this way, we can see that  $\mathbb{P}_{\mathbb{R}}^2 = \mathbb{E}^2 \sqcup \mathbb{P}_{\mathbb{R}}^1$ , where  $\mathbb{E}^2 = T$  and  $\mathbb{P}_{\mathbb{R}}^1 = L_0$ .

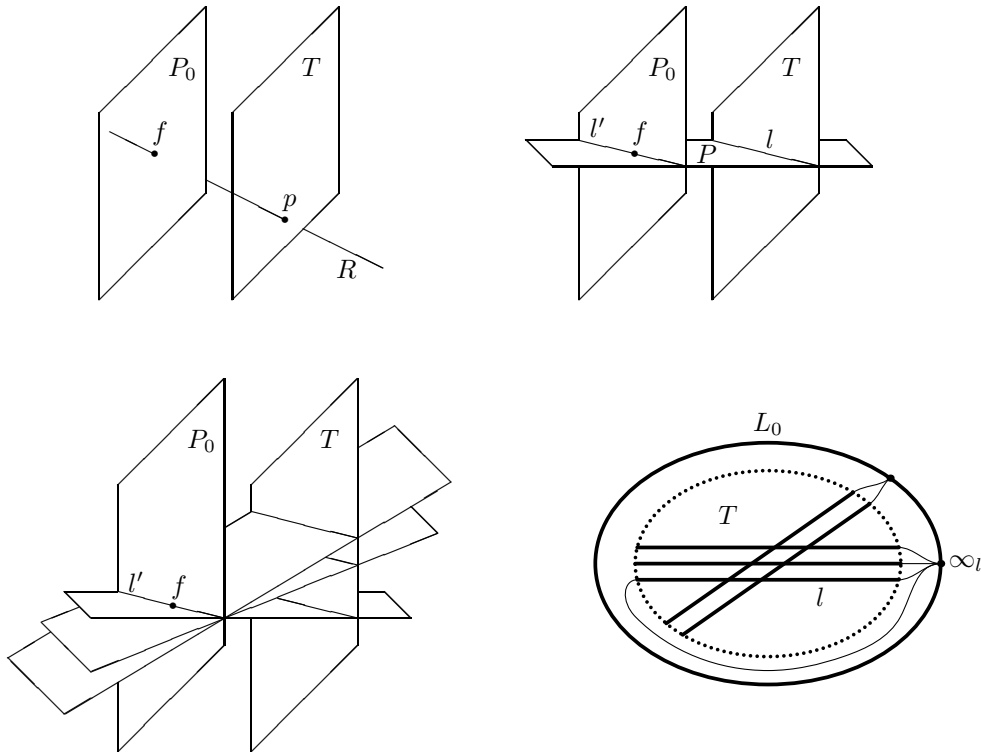

Let  $L \subset \mathbb{P}_{\mathbb{R}}^2$  be a line in  $\mathbb{P}_{\mathbb{R}}^2$  distinct from  $L_0$  and let  $P$  be the plane related to  $L$ . So,  $P$  is not parallel to  $T$ . Therefore, the line  $l = T \cap P$  in the plane  $T$  is the shadow of the line  $L$  in  $\mathbb{P}_{\mathbb{R}}^2$ . In the above terms, we have  $L = l \sqcup \{\infty_l\}$ , where the point  $\infty_l \in L_0 \subset \mathbb{P}_{\mathbb{R}}^2$  corresponds to the line  $l' = P_0 \cap P \subset \mathbb{E}^3$ . In this way, we obtain a one-to-one correspondence between the lines in  $T$  and the lines in  $\mathbb{P}_{\mathbb{R}}^2$  distinct

from  $L_0$ . Each line  $l \subset T$  is extended in  $\mathbb{P}_{\mathbb{R}}^2$  by its point at infinity  $\infty_l \in L_0$ . The line  $L_0 \subset \mathbb{P}_{\mathbb{R}}^2$  is formed by all points at infinity of the lines in  $T$ .

It is easy to see that two lines are parallel in  $T$  iff their points at infinity are equal. In other words, each family of parallel lines in  $T$  is formed by the lines in  $\mathbb{P}_{\mathbb{R}}^2$  that pass through a same point in  $L_0$ . Hence, the infinity line  $L_0$  can be seen as a list of such families.

Moving along a line  $l \subset T$ , independently of the chosen direction, we finally arrive at the point at infinity  $\infty_l \in L_0$ . We arrive at the same point  $\infty_l$  if moving along a line parallel to  $l$  and at a different point if moving along a line non-parallel to  $l$ .

The following remark is easy, but very important: *Every line in  $\mathbb{P}_{\mathbb{R}}^2$  can be taken as the infinity line.* This solves Problem 2.1 immediately! Indeed, consider the plane  $\mathbb{E}^2$  as being inside the real projective plane  $\mathbb{E}^2 \subset \mathbb{P}_{\mathbb{R}}^2$  and use a more powerful ruler that allows us to draw the line in the projective plane  $\mathbb{P}_{\mathbb{R}}^2$  through any two distinct points. Let us assume that it is possible to construct the parallel line  $R'$ . Then we can construct the intersection at infinity  $\{q\} = R \cap R'$ . Let  $Q$  be the finite set,  $p, q \in Q$ , of all points that subsequently appear during the construction. Such points are intersection points of lines in  $\mathbb{P}_{\mathbb{R}}^2$  that were already constructed at previous stages plus a finite number of arbitrarily chosen points (that may or may not belong to the lines that were already constructed). We choose a new infinity line  $L'_0$  in such a way that  $L'_0$  passes through no point in  $Q$ . We take  $\mathbb{E}'^2 := \mathbb{P}_{\mathbb{R}}^2 \setminus L'_0$  as a new (usual) plane. Now, the construction in this new plane  $\mathbb{E}'^2$  has to provide the same line  $R'$  which, on the other hand, is not parallel to  $R$  because  $\{q\} = R \cap R' \subset \mathbb{E}'^2 = \mathbb{P}_{\mathbb{R}}^2 \setminus L'_0$ . A contradiction.

Using the more powerful ruler, it is easy to solve the following

**2.3. Exercise.** Let  $R_1, R_2$  be distinct parallel lines in the Euclidean plane  $\mathbb{E}^2$  and let  $p \notin R_1, R_2$  be a point,  $R_1, R_2 \not\cong p \in \mathbb{E}^2$ . Is it possible, using only a ruler, to construct the line  $R$  passing through  $p$  and parallel to  $R_1, R_2$ ?

Now, we try to visualize the real projective plane  $\mathbb{P}_{\mathbb{R}}^2$ . Every sphere  $\mathbb{S}^2 \subset \mathbb{E}^3$  centred at  $f$  lists the points in  $\mathbb{P}_{\mathbb{R}}^2$ : each point in  $\mathbb{P}_{\mathbb{R}}^2$  is listed twice by a pair of diametrically opposed points in the sphere. But this does not give the faintest idea about the space  $\mathbb{P}_{\mathbb{R}}^2$ . In order to understand better the *topology* of the real projective plane, we initially cut  $\mathbb{S}^2$  into four pieces and disregard two redundant ones. Performing

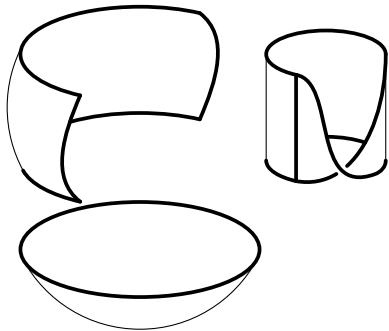

the necessary identifications in one of the two remaining pieces, we obtain a *Möbius band*. It remains to identify the disc and the Möbius band along their boundaries which are circles. In this way, the structure of the space  $\mathbb{P}_{\mathbb{R}}^2$  becomes more or less clear. Unfortunately, it is impossible to perform such a gluing inside  $\mathbb{E}^3$ .

**2.4. Exercise.** Every line divides the plane  $\mathbb{E}^2$  into two parts. Into how many parts 4 generic lines in  $\mathbb{P}_{\mathbb{R}}^2$  divide the real projective plane?

**2.5. Exercise.** Visualize the space formed by all unordered pairs of points in the circle.

**2.6. Projective space.** Let  $V$  be a finite-dimensional  $\mathbb{K}$ -linear space, where  $\mathbb{K} = \mathbb{R}$  or  $\mathbb{K} = \mathbb{C}$ . We define the *projective space* as  $\mathbb{P}_{\mathbb{K}}V := V \cdot / \mathbb{K} \cdot$ , where  $V \cdot := V \setminus \{0\}$  is the linear space  $V$  ‘punctured’ at the origin,  $\mathbb{K} \cdot$  is (the group of) all non-null elements in  $\mathbb{K}$ , and  $V \cdot / \mathbb{K} \cdot$  is the *quotient* of the *action* of  $\mathbb{K} \cdot$  on  $V \cdot$ . This means that  $V \cdot / \mathbb{K} \cdot$  is the set of equivalence classes in  $V \cdot$  given by proportionality with coefficients in  $\mathbb{K} \cdot$ . (We also denote  $\mathbb{P}_{\mathbb{K}}V = \mathbb{P}_{\mathbb{K}}^n$  if  $\dim_{\mathbb{K}} V = n + 1$ .) We have the quotient map  $\pi : V \cdot \rightarrow \mathbb{P}_{\mathbb{K}}V$  sending every element to its class. In what follows, we frequently use elements in  $V$  to denote elements in the projective space, that is, we write  $p$  in place of  $\pi(p)$ . In such cases, the reader is supposed to verify that our considerations do not change if we rechoose representatives in  $V$  of points in the projective space. One more convention. Given a subset  $S \subset V$ , we denote by



$\mathbb{P}_{\mathbb{K}}S := \pi(S \setminus \{0\}) \subset \mathbb{P}_{\mathbb{K}}V$  the image of  $S \subset V$  under the quotient map  $\pi : V \rightarrow \mathbb{P}_{\mathbb{K}}V$ . In this way, for every  $\mathbb{K}$ -linear subspace  $K \leq V$ , we can consider the projective space  $\mathbb{P}_{\mathbb{K}}K$  as a (linear) subspace in  $\mathbb{P}_{\mathbb{K}}V$ .

Let  $f : V \rightarrow \mathbb{K}$  be a non-null linear functional. We put  $T := \{v \in V \mid fv = 1\}$  and  $K := \ker f$ . There is an identification  $(\mathbb{P}_{\mathbb{K}}V \setminus \mathbb{P}_{\mathbb{K}}K) \simeq T$  given by the rule  $v \mapsto \frac{v}{fv}$ . As above, we arrive at the decomposition  $\mathbb{P}_{\mathbb{K}}^n = \mathbb{A}_{\mathbb{K}}^n \sqcup \mathbb{P}_{\mathbb{K}}^{n-1}$ , where the screen  $\mathbb{A}_{\mathbb{K}}^n := T$  is a  $\mathbb{K}$ -affine space (= a  $\mathbb{K}$ -linear space that has forgotten its origin) of dimension  $n$ . In terms of  $\mathbb{P}_{\mathbb{K}}V$ , we can describe  $T$  as  $\{p \in \mathbb{P}_{\mathbb{K}}V \mid fp \neq 0\}$  and  $\mathbb{P}_{\mathbb{K}}K$  as  $\{p \in \mathbb{P}_{\mathbb{K}}V \mid fp = 0\}$ . (In the expression  $fp$ , the point  $p$  is to be considered as  $p \in V$ , but notice that the equality  $fp = 0$  and the inequality  $fp \neq 0$  do not change their meaning if we rechoose the representative of the point. — This is an example of the above mentioned use of elements in  $V$  to denote points in the projective space.)

Let  $x_0, x_1, \dots, x_n : V \rightarrow \mathbb{K}$  be linear coordinates on  $V$ . We can define *projective coordinates*  $[x_0, x_1, \dots, x_n]$  on  $\mathbb{P}_{\mathbb{K}}V$  by assuming that  $[kx_0, kx_1, \dots, kx_n] = [x_0, x_1, \dots, x_n]$  for all  $k \in \mathbb{K}^*$ . Thus, considering each projective coordinate separately does not provide any meaningful number (but it makes sense to say whether a coordinate vanishes or not). However, when considered as entity, the projective coordinates are a mere proportion.

Taking  $n+1$  screens,  $U_i := \{p \in \mathbb{P}_{\mathbb{K}}V \mid x_i p \neq 0\}$ ,  $i = 0, 1, \dots, n$ , we have  $\mathbb{P}_{\mathbb{K}}V = \bigcup_{i=0}^n U_i$ . Each  $U_i$  has  $n$  affine coordinates  $y_0, y_1, \dots, y_{i-1}, y_{i+1}, \dots, y_n$  defined by the rule  $y_j := x_j/x_i$ . The intersection  $U_i \cap U_k$  is described as  $U_{ik} := \{p \in U_i \mid y_k(p) \neq 0\}$  in terms of the coordinates  $y_0, y_1, \dots, y_{i-1}, y_{i+1}, \dots, y_n$  on  $U_i$ . The same intersection is described as  $U_{ki} = \{p \in U_k \mid z_i(p) \neq 0\}$  in terms of the coordinates  $z_0, z_1, \dots, z_{k-1}, z_{k+1}, \dots, z_n$  on  $U_k$ . Hence,  $U_{ik}$  is identified with  $U_{ki}$  by means of the map

$$U_{ik} \rightarrow U_{ki}, \quad (y_0, y_1, \dots, y_{i-1}, y_{i+1}, \dots, y_n) \mapsto \left( \frac{y_0}{y_k}, \frac{y_1}{y_k}, \dots, \frac{y_{i-1}}{y_k}, \frac{1}{y_k}, \frac{y_{i+1}}{y_k}, \dots, \frac{y_{k-1}}{y_k}, \frac{y_{k+1}}{y_k}, \dots, \frac{y_n}{y_k} \right).$$

In this way, we may interpret  $\mathbb{P}_{\mathbb{K}}^n$  as a gluing of  $n+1$  copies of  $\mathbb{A}_{\mathbb{K}}^n$  identified by the above maps.

For instance, the space  $\mathbb{P}_{\mathbb{C}}^1$  can be seen as the gluing of two copies of  $\mathbb{C}$ , equipped with the coordinates  $x_i$ ,  $i = 0, 1$ , in such a way that the identification between  $U_1 \supset U_{10} \simeq \mathbb{C}^*$  and  $U_0 \supset U_{01} \simeq \mathbb{C}^*$  is given by the formula  $x_0 x_1 = 1$ . In particular, we visualize  $\mathbb{P}_{\mathbb{C}}^1$  as  $\{[1, x_1] \mid x_1 \in \mathbb{C}\} \simeq \mathbb{C}$  extended by the point at infinity  $\infty = [0, 1]$ .

**2.7. Sphere and stereographic projection.** Let  $V$  be an  $\mathbb{R}$ -linear space,  $\dim_{\mathbb{R}} V = n+1$ . We define the *n-sphere* as being  $\mathbb{S}^n := V/\mathbb{R}^+$ , where  $\mathbb{R}^+ := \{r \in \mathbb{R} \mid r > 0\}$ . A more common definition of the unit  $n$ -sphere inside Euclidean space is  $\mathbb{S}^n := \{p \in \mathbb{E}^{n+1} \mid \langle p, p \rangle = 1\}$ , where  $\langle -, - \rangle$  stands for the usual inner product in  $\mathbb{E}^{n+1}$ . We define the *tangent space*  $T_p \mathbb{S}^n$  to  $\mathbb{S}^n$  at  $p \in \mathbb{S}^n$  as  $T_p \mathbb{S}^n := p^\perp \leq \mathbb{E}^{n+1}$ . In order to have a hyperplane that is indeed tangent to the sphere at  $p$ , it is better to take  $p + p^\perp$  in place of  $p^\perp$ , but we prefer the above definition as it provides an obvious linear space. The *stereographic projection*  $\varsigma_p : \mathbb{S}^n \setminus \{-p\} \rightarrow T_p \mathbb{S}^n$  sends the point  $q \in \mathbb{S}^n \setminus \{-p\}$  to the intersection  $T_p \mathbb{S}^n \cap R(-p, q)$ , where  $R(-p, q)$  denotes the line joining  $-p$  and  $q$ .

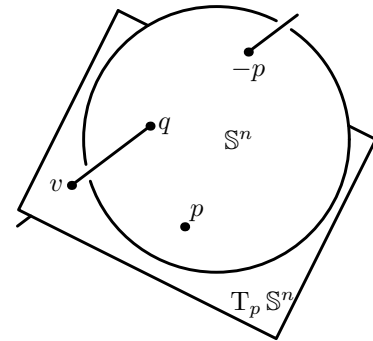

When  $n = 2$ , we can interpret the stereographic projection as ‘unwrapping’ the sphere punctured at the point  $-p$  into the plane tangent to the sphere at the point  $p$ . This unwrapping is one of the typical ways of exhibiting geographic maps.

**2.8. Exercise.** Prove the explicit formulae

$$\varsigma_p : \mathbb{S}^n \setminus \{-p\} \ni q \mapsto \frac{q+p}{1+\langle q,p \rangle} - p \in T_p \mathbb{S}^n, \quad \varsigma_p^{-1} : T_p \mathbb{S}^n \ni v \mapsto \frac{2(v+p)}{1+\langle v,v \rangle} - p \in \mathbb{S}^n \setminus \{-p\}.$$

**2.9. Riemann sphere.** Using a couple of stereographic projections, we can see that  $\mathbb{P}_{\mathbb{C}}^1 \simeq \mathbb{S}^2$ . Indeed, let us treat the tangent planes  $T_p \mathbb{S}^2$  and  $T_{-p} \mathbb{S}^2$  to the unit sphere  $\mathbb{S}^2$  at the diametrically opposed points  $p, -p \in \mathbb{S}^2 \subset \mathbb{E}^3$  as being planes of complex numbers,  $T_p \mathbb{S}^2 \simeq \mathbb{C}_0$  and  $T_{-p} \mathbb{S}^2 \simeq \mathbb{C}_1$ , in such a way that the real axes are parallel with the same directions and the imaginary axes are parallel with the opposite directions. (In order to facilitate the visualization, we draw the tangent planes as passing through the points,  $p \in T_p \mathbb{S}^2$  and  $-p \in T_{-p} \mathbb{S}^2$ .) Let  $0 \neq x \in \mathbb{C}_0 \simeq T_p \mathbb{S}^2 = p^\perp$ . Applying the formulae from Exercise 2.8, we obtain  $\varsigma_{-p} \varsigma_p^{-1} x = x / \langle x, x \rangle = 1/\bar{x}$ , which corresponds to  $1/x \in \mathbb{C}_1 \simeq T_{-p} \mathbb{S}^2$ . In other words, the gluing of the planes  $T_p \mathbb{S}^2$  and  $T_{-p} \mathbb{S}^2$  resulting in  $\mathbb{S}^2$  is the same as the above described gluing of  $U_0$  and  $U_1$  resulting in  $\mathbb{P}_{\mathbb{C}}^1$ .

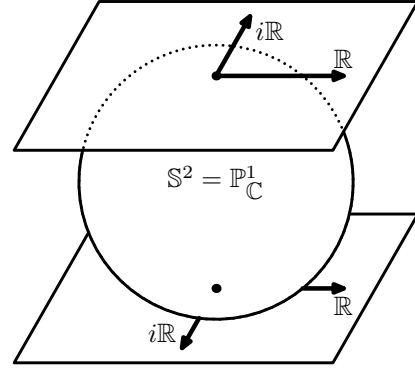

**2.10. Exercise.** Prove that the stereographic projection  $\varsigma_p$  establishes a one-to-one correspondence between subspheres in  $\mathbb{S}^n$  (= intersections of  $\mathbb{S}^n$  with affine subspaces in  $\mathbb{E}^{n+1}$ ) and subspheres or affine subspaces in  $T_p \mathbb{S}^n$ .

**2.11. Exercise.** Prove that the stereographic projection preserves angles between curves.

**2.12A. Grassmannians.** We take and fix finite-dimensional  $\mathbb{K}$ -linear spaces  $P, V$  and denote by

$$M := \{p \in \text{Lin}_{\mathbb{K}}(P, V) \mid \ker p = 0\}$$

the open subset of all monomorphisms in the  $\mathbb{K}$ -linear space  $\text{Lin}_{\mathbb{K}}(P, V)$ . The group  $\text{GL}_{\mathbb{K}} P$  of all nondegenerate  $\mathbb{K}$ -linear transformations of  $P$  acts from the right on  $\text{Lin}_{\mathbb{K}}(P, V)$  and on  $M$ . By definition, the *grassmannian*  $\text{Gr}_{\mathbb{K}}(k, V)$  is the quotient space

$$\text{Gr}_{\mathbb{K}}(k, V) := M / \text{GL}_{\mathbb{K}} P, \quad \pi : M \rightarrow M / \text{GL}_{\mathbb{K}} P,$$

where  $k := \dim_{\mathbb{K}} P$ . It is the space of all  $k$ -dimensional  $\mathbb{K}$ -linear subspaces in  $V$ . In the case of  $\mathbb{K} = \mathbb{R}$ , we can also take the group  $\text{GL}_{\mathbb{R}}^+ P := \{g \in \text{GL}_{\mathbb{R}} P \mid \det g > 0\}$  in place of  $\text{GL}_{\mathbb{K}} P$ , obtaining the *grassmannian*

$$\text{Gr}_{\mathbb{R}}^+(k, V) := M / \text{GL}_{\mathbb{R}}^+ P, \quad \pi' : M \rightarrow M / \text{GL}_{\mathbb{R}}^+ P$$

of *oriented*  $k$ -dimensional  $\mathbb{R}$ -linear subspaces in  $V$ .

### 3. Smooth spaces and smooth functions

Why do we feel that the 2-sphere is smooth and the (surface of a 3-) cube is not? We guess that the concept of smooth function answers well this question. Everybody knows, at least at the level of intuition, what a smooth function is.<sup>6</sup> Actually, instead of any kind of formal definition, it seems better to simply list the properties of (smooth) functions that we are going to use. Inevitably, we are to simultaneously introduce the properties of (smooth) spaces.

In this section, we try to focus ourselves on understanding and clarifying the nature of objects and concepts. It turns out that our introduction to differential topology came out a little bit nonstandard,

<sup>6</sup>The following story about the ‘Grothendieck prime’ (Alexander Grothendieck, one of the greatest mathematicians of our times) comes to mind. Somebody suggested: ‘Pick a prime number.’ Grothendieck replied: ‘You mean like 57?’

but this pays off: the same exposition works for algebraic/complex geometry. The reader is welcome to get back to this material and give it a broader look; however, in the first reading, one may opt to stuck with usual smooth functions and spaces.

**3.1. Introductory remarks.** We fix some field  $\mathbb{K}$ . In our applications, it will be the field  $\mathbb{R}$  of real numbers or the field  $\mathbb{C}$  of complex numbers. We would like to speak of local  $\mathbb{K}$ -valued ‘smooth’ functions  $M \circlearrowleft U \xrightarrow{f} \mathbb{K}$  defined on open subsets  $U \subset \circlearrowleft M$  of a given topological space  $M$ . Denote by  $\mathcal{F}$  all such functions and by  $\mathcal{F}(U)$ , those with a given  $U \subset \circlearrowleft M$ . We can sum and multiply the functions in  $\mathcal{F}(U)$ . Naturally, the constant functions should be included in  $\mathcal{F}(U)$ . In other words,  $\mathcal{F}(U)$  is a commutative  $\mathbb{K}$ -algebra. A more important feature of ‘smooth’ functions is that this concept is **local**. This means that, for  $W \subset \circlearrowleft U \subset \circlearrowleft M$  and  $f \in \mathcal{F}(U)$ , the restriction  $f|_W : W \rightarrow \mathbb{K}$  belongs to  $\mathcal{F}(W)$  and *vice versa*: if a function is locally ‘smooth,’ it must be ‘smooth.’ Thus, we arrive at the following definition.

**3.2. Sheaves of functions.** Let  $M$  be a topological space and let  $\mathcal{F} := \bigsqcup_{U \subset \circlearrowleft M} \mathcal{F}(U)$  be a collection of  $\mathbb{K}$ -valued functions such that  $\mathcal{F}(U)$  is a  $\mathbb{K}$ -algebra for every  $U \subset \circlearrowleft M$  and the following conditions hold.

- If  $W \subset \circlearrowleft U \subset \circlearrowleft M$  and  $f \in \mathcal{F}(U)$ , then  $f|_W \in \mathcal{F}(W)$ .
- Let us be given open subsets  $U_i \subset \circlearrowleft M$ ,  $i \in I$ , and a function  $U \xrightarrow{f} \mathbb{K}$ , where  $U := \bigcup_{i \in I} U_i$ . If  $f|_{U_i} \in \mathcal{F}(U_i)$  for every  $i \in I$ , then  $f \in \mathcal{F}(U)$ .

Then  $\mathcal{F}$  is a *sheaf* of  $\mathbb{K}$ -valued functions on  $M$ .

Speaking slightly informally, a sheaf of functions corresponds to a local property of a  $\mathbb{K}$ -valued function preserved by the  $\mathbb{K}$ -algebra operations.

Let  $p \in M$  be fixed, let  $p \in U_1, U_2 \subset \circlearrowleft M$ , and let  $f_i \in \mathcal{F}(U_i)$ ,  $i = 1, 2$ . We write  $f_1 \sim f_2$  if there exists  $U \subset \circlearrowleft U_1 \cap U_2$  such that  $p \in U$  and  $f_1|_U = f_2|_U$ . Obviously,  $\sim$  is an equivalence relation. The corresponding equivalence class  $f_p$  is the *germ* of  $f \in \mathcal{F}$  at  $p$ . All germs at  $p$  form the *stalk*  $\mathcal{F}_p$  of  $\mathcal{F}$  at  $p$ . The stalk is a  $\mathbb{K}$ -algebra and, for  $p \in U \subset \circlearrowleft M$ , we have the homomorphism  $\mathcal{F}(U) \rightarrow \mathcal{F}_p$ ,  $f \mapsto f_p$ , of  $\mathbb{K}$ -algebras which is compatible with restrictions.

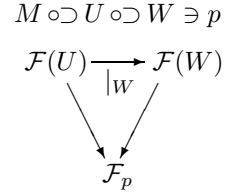

The  $\mathbb{K}$ -algebra  $\mathcal{F}_p$  splits into  $\mathbb{K}$  (the constants) and the ideal  $\mathfrak{m}_p := \{f_p \mid f(p) = 0\} \triangleleft \mathcal{F}_p$  formed by the germs that vanish at  $p$ . So,  $\mathcal{F}_p = \mathbb{K} + \mathfrak{m}_p$ .

**3.3. Basic example.** Let  $V$  be a finite-dimensional  $\mathbb{K}$ -linear space equipped with the usual topology. Let  $p \in U \subset \circlearrowleft V$ ,  $f : U \rightarrow \mathbb{K}$ , and  $v \in V$  be a point, a function, and a vector. We denote by

$$v_p f := \lim_{\varepsilon \rightarrow 0} \frac{f(p + \varepsilon v) - f(p)}{\varepsilon}$$

the *v-directional derivative* of  $f$  at  $p$ . If  $f := \varphi|_U$ , where  $\varphi \in V^* := \text{Lin}_{\mathbb{K}}(V, \mathbb{K})$  is a  $\mathbb{K}$ -linear functional, then such a derivative exists and equals  $v_p f = \varphi v$ . Of course,  $v_p c = 0$  for any constant function  $c$ . If  $v_p f$  exists for every  $p \in U$ , we define the *partial derivative*  $[v]_U f : U \rightarrow \mathbb{K}$  by the rule  $[v]_U f : p \mapsto v_p f$ . A continuous function  $f : U \rightarrow \mathbb{K}$  is said to be *smooth of class  $C^0$* . By induction, a function  $f : U \rightarrow \mathbb{K}$  is *smooth of class  $C^k$*  iff the function  $[v]_U f : U \rightarrow \mathbb{K}$  (exists and) is smooth of class  $C^{k-1}$  for every  $v \in V$ . A function  $f : U \rightarrow \mathbb{K}$  is *smooth (of class  $C^\infty$ )* iff it is smooth of class  $C^k$  for every  $k \geq 0$ .

**3.3.1. Exercise.** Let  $f_1, f_2 : U \rightarrow \mathbb{K}$ ,  $p \in U \subset \circlearrowleft V$ , and  $v \in V$  be such that  $v_p f_1, v_p f_2$  exist. Show that  $v_p(f_1 + f_2), v_p(f_1 f_2)$  exist and

$$v_p(f_1 + f_2) = v_p f_1 + v_p f_2, \quad v_p(f_1 f_2) = f_1(p) v_p f_2 + f_2(p) v_p f_1.$$

(The latter is the well-known *Leibniz rule*.) Show that  $C^k$ , formed by all smooth functions of class  $C^k$ ,  $0 \leq k \leq \infty$ , is a sheaf of  $\mathbb{K}$ -valued functions on  $V$ . We have  $C^k(U) \subset C^{k-1}(U)$  and  $[v]_U : C^k(U) \rightarrow$

$C^{k-1}(U)$  for all  $v \in V$  and  $U \subset \circ V$ . Note that  $[v]_U$  is compatible with restrictions. So, we can write  $[v]$  instead of  $[v]_U$ .

**3.3.2. Exercise.** If  $v_p f$  exists, then  $(kv)_p f$  exists and  $(kv)_p f = kv_p f$  for every  $k \in \mathbb{K}$ . For  $f \in C^1$  and  $v, w \in V$ , we have  $[v+w]f = [v]f + [w]f$ .

**3.3.3. Exercise** (Taylor's formula). Let  $p \in V$  and  $g \in C_p^\infty$ . Then there exist a unique linear functional  $\varphi \in V^*$  and  $h \in \mathfrak{m}_p^2$  such that  $g = g(p) + \varphi_p - \varphi p + h$ .

**3.3.4. Exercise.** Show that the topology on  $V$  is the weakest one such that all functions  $C^\infty(V) \ni f : V \rightarrow \mathbb{K}$  are continuous.

**3.3.5. Exercise.** Let  $V \circ \supset U \xrightarrow{\psi} W$  be a map into a finite-dimensional  $\mathbb{K}$ -linear space  $W$ . Suppose that  $W^* \circ \psi \subset C^\infty(U)$ . Show that  $\psi$  is continuous and that  $f \circ \psi \in C^\infty(\psi^{-1}(X))$  for all  $X \subset \circ W$  and  $f \in C^\infty(X)$ .

Until the end of this section, the reader may assume for simplicity that the sheaves we deal with are all induced by the sheaves  $C^\infty$ .

**3.4. Smooth maps and induced structures.** Let  $(M_1, \mathcal{F}_1)$  and  $(M_2, \mathcal{F}_2)$  be spaces with sheaves of functions. A continuous map  $\psi : M_1 \rightarrow M_2$  is 'smooth' if  $f_2 \circ \psi \in \mathcal{F}_1(\psi^{-1}(U_2))$  for all  $U_2 \subset \circ M_2$  and  $f_2 \in \mathcal{F}_2(U_2)$ .

Let  $(M_2, \mathcal{F}_2)$  be a space with a sheaf of functions and let  $\varphi : M \rightarrow M_2$  be a map. Then there exist a weakest topology and a smallest sheaf  $\mathcal{F}$  of functions on  $M$  such that  $\varphi$  is smooth. More precisely, the open subsets in  $M$  are of the form  $U = \varphi^{-1}(U_2)$ , where  $U_2 \subset \circ M_2$ . A function  $M \circ \supset U \xrightarrow{f} \mathbb{K}$  belongs to  $\mathcal{F}(U)$  iff it is locally of the form  $f_2 \circ \varphi$ , i.e., iff there exist an open cover  $U_2 = \bigcup_{i \in I} U_i$  and functions

$f_i \in \mathcal{F}_2(U_i)$  such that  $U = \varphi^{-1}(U_2)$  and  $f|_{\varphi^{-1}(U_i)} = f_i \circ \varphi$  for all  $i \in I$ . The introduced structure on  $M$  is called *induced* by  $\varphi$ . It is universal in the following sense. If  $\psi = \varphi \circ \vartheta$  for some map  $M_1 \xrightarrow{\psi} M_2$   $\vartheta : M_1 \rightarrow M$  and a smooth map  $(M_1, \mathcal{F}_1) \xrightarrow{\psi} (M_2, \mathcal{F}_2)$ , then  $\vartheta$  is smooth. The concept of induced structure usually applies to subsets  $M \subset M_2$ . In this case, the induced sheaf is denoted by  $\mathcal{F}_2|_M$ . In the easy (and important) case of  $M \subset \circ M_2$ , we have  $\mathcal{F}_2|_M = \bigsqcup_{U \subset \circ M} \mathcal{F}_2(U)$ .

Let  $(M_1, \mathcal{F}_1)$  be a space with a sheaf of functions and let  $\varphi : M_1 \rightarrow M$  be a map. Then there exist a strongest topology and a largest sheaf  $\mathcal{F}$  of functions on  $M$  such that  $\varphi$  is smooth. More precisely,  $U \subset \circ M$  iff  $\varphi^{-1}(U) \subset \circ M_1$  and  $M \circ \supset U \xrightarrow{f} \mathbb{K}$  belongs to  $\mathcal{F}(U)$  iff  $f \circ \varphi \in \mathcal{F}_1(\varphi^{-1}(U))$ . The introduced structure on  $M$  is called the *quotient* by  $\varphi$ . It is universal in the following sense. If  $\psi = \varphi \circ \vartheta$  for some map  $\vartheta : M \rightarrow M_2$  and a smooth map  $(M_1, \mathcal{F}_1) \xrightarrow{\psi} (M_2, \mathcal{F}_2)$ , then  $\vartheta$  is smooth. The concept of quotient structure usually applies to the quotient by an equivalence relation  $M_1 \rightarrow M := M_1 / \sim$ .

**3.4.1. Exercise.** Let  $(M, \mathcal{F})$  and  $(N, \mathcal{G})$  be spaces with sheaves of functions, let  $\psi : M \rightarrow N$  be a map, and let  $N = \bigcup_{i \in I} U_i$  and  $\psi^{-1}(U_i) = \bigcup_{j \in J_i} U_{ij}$ ,  $i \in I$ , be open covers. Show that  $\psi$  is smooth iff all  $\psi|_{U_{ij}} : U_{ij} \rightarrow U_i$  are smooth, where  $U_i$  and  $U_{ij}$  are equipped with the induced structures. In other words, the concept of a smooth map is local.

**3.4.2. Exercise.** Let  $M$  be a set and suppose that  $M = \bigcup_{i \in I} M_i$ , where every  $M_i$  is equipped with a topology and a sheaf  $\mathcal{F}_i$  of  $\mathbb{K}$ -valued functions such that  $M_i \cap M_j \subset \circ M_i$  and  $\mathcal{F}_i|_{M_i \cap M_j} = \mathcal{F}_j|_{M_i \cap M_j}$  for all  $i, j \in I$ . Verify that there exist a unique topology and a sheaf  $\mathcal{F}$  on  $M$  such that  $M_i \subset \circ M$  and the structure on  $M_i$  is induced by that on  $M$  for all  $i \in I$ . In this situation, we say that  $(M, \mathcal{F})$  is a *gluing* of  $(M_i, \mathcal{F}_i)$ ,  $i \in I$ . We have already seen a couple of examples of gluing in Subsections 2.6 and 2.9.

**3.4.3. Example.** Let  $V$  be an  $\mathbb{R}$ -linear space with  $\dim_{\mathbb{R}} V = n + 1$ . Then  $V^\bullet := V \setminus \{0\} \subset V$  gets the induced  $C^\infty$ -structure. If  $v_2 = rv_1$  for some  $r > 0$ , we write  $v_1 \sim v_2$ . Then we obtain the quotient structure on the  $n$ -sphere  $\mathbb{S}^n := V^\bullet / \sim$  and the smooth map  $\pi : V^\bullet \rightarrow \mathbb{S}^n$ .

**3.4.4A. Example.** More generally, the grassmannians  $\pi : M \rightarrow \text{Gr}_{\mathbb{R}}(k, V)$  and  $\pi' : M \rightarrow \text{Gr}_{\mathbb{R}}^+(k, V)$  (see 2.12A) are equipped with the quotient structure.

**3.4.5. Example.** Let  $V$  be an Euclidean  $\mathbb{R}$ -linear space with  $\dim_{\mathbb{R}} V = n + 1$ . Then  $S := \{v \in V \mid \langle v, v \rangle = 1\} \subset V$  is closed. We have the induced  $C^\infty$ -structure on  $S \subset V^\bullet$ .

**3.4.6. Exercise.** Show that the composition  $S \hookrightarrow V^\bullet \xrightarrow{\pi} \mathbb{S}^n$  (see Examples 3.4.3 and 3.4.5) is a diffeomorphism (i.e., a smooth isomorphism).

**3.5. Product and fibre product.** We fix a certain class  $\mathcal{C}$  of spaces with sheaves of  $\mathbb{K}$ -valued functions and assume that  $\mathcal{C}$  is closed with respect to taking open subspaces (equipped with the induced structure) and with respect to gluing. So, for a gluing  $M = \bigcup_{i \in I} M_i$ , we have  $M_i \in \mathcal{C}$  for all  $i \in I$  iff

$M \in \mathcal{C}$  (actually, we will need only the gluings with countable or finite  $I$ ). In other words, the property ‘to belong to  $\mathcal{C}$ ’ is local.

**3.5.1. Product.** Let  $M_1, M_2 \in \mathcal{C}$ . A structure on  $M_1 \times M_2$  providing  $M_1 \times M_2 \in \mathcal{C}$  is a  $\mathcal{C}$ -product if the projections  $\pi_i : M_1 \times M_2 \rightarrow M_i$  are smooth and, for any  $M \in \mathcal{C}$  and smooth maps  $\psi_i : M \rightarrow M_i$ , the map  $\psi : M \rightarrow M_1 \times M_2$  in the commutative diagram is smooth.

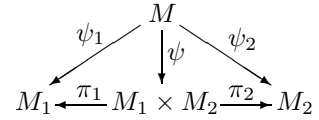

**3.5.2. Exercise.** Let  $M_1, M_2 \in \mathcal{C}$ . Show that a  $\mathcal{C}$ -product structure on  $M_1 \times M_2$  is unique if it exists.

**3.5.3. Exercise.** Let  $S_1, S_2, S_1 \times S_2, M_1, M_2, M_1 \times M_2 \in \mathcal{C}$ , where  $S_i \subset M_i$ ,  $i = 1, 2$ , and  $S_1 \times S_2 \subset M_1 \times M_2$  are equipped with the induced structures and  $M_1 \times M_2$  is a  $\mathcal{C}$ -product. Prove that  $S_1 \times S_2$  is a  $\mathcal{C}$ -product.

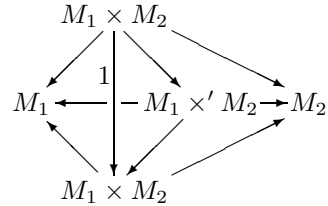

**3.5.4. Exercise.** Let  $M_i, N_j \in \mathcal{C}$  for all  $i \in I$  and  $j \in J$  and let  $M = \bigcup_{i \in I} M_i$  and  $N = \bigcup_{j \in J} N_j$  be gluings. Suppose

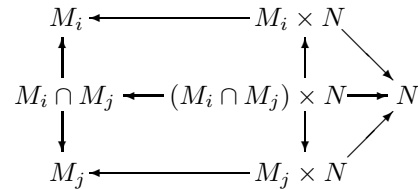

that there exists a  $\mathcal{C}$ -product structure on  $M_i \times N_j$  for all  $i \in I$  and  $j \in J$ . Show that the gluing of  $M_i \times N_j$  provides a  $\mathcal{C}$ -product structure on  $M \times N$ .

**3.5.5. Fibre product.** Let  $M_1, M_2, B \in \mathcal{C}$  and let  $\varphi_i : M_i \rightarrow B$  be smooth maps,  $i = 1, 2$ . We define

$$M_1 \times_B M_2 := \{(p_1, p_2) \in M_1 \times M_2 \mid \varphi_1(p_1) = \varphi_2(p_2)\},$$

$$\pi_i : M_1 \times_B M_2 \rightarrow M_i, \quad \pi_i : (p_1, p_2) \mapsto p_i, \quad i = 1, 2.$$

Clearly,  $\varphi_1 \circ \pi_1 = \varphi_2 \circ \pi_2$ . A structure on  $M_1 \times_B M_2$  providing  $M_1 \times_B M_2 \in \mathcal{C}$  is a *fibre product* in  $\mathcal{C}$  (or a *fibre product  $\mathcal{C}$ -structure*) if  $\pi_1, \pi_2$  are smooth and, for any  $M \in \mathcal{C}$  and smooth maps  $M_1 \xleftarrow{\psi_1} M \xrightarrow{\psi_2} M_2$  such that  $\varphi_1 \circ \psi_1 = \varphi_2 \circ \psi_2$ , the map  $\psi : M \rightarrow M_1 \times_B M_2$  in the commutative diagram is smooth.

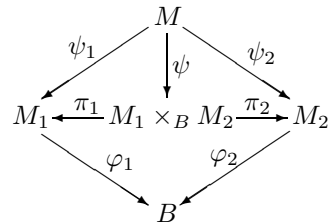

It is frequently useful to visualize the fibre product  $M_1 \times_B M_2$  as a family of products parameterized by  $B$ . More specifically,  $M_1 \times_B M_2 = \bigsqcup_{p \in B} \varphi_1^{-1}(p) \times \varphi_2^{-1}(p)$ , where  $\varphi_1^{-1}(p) \times \varphi_2^{-1}(p)$  is the product of the *fibres* of  $\varphi_1$  and  $\varphi_2$  over  $p \in B$ .

**3.5.6. Exercise.** Let  $M_1, M_2, B \in \mathcal{C}$ . Show that a fibre product  $\mathcal{C}$ -structure on  $M_1 \times_B M_2$  is unique if it exists.

**3.5.7. Exercise.** Let  $M_1, M_2, B, M_1 \times M_2, M_1 \times_B M_2 \in \mathcal{C}$ , where  $M_1 \times M_2$  is a  $\mathcal{C}$ -product and  $M_1 \times_B M_2 \subset M_1 \times M_2$  is equipped with the induced structure. Prove that  $M_1 \times_B M_2$  is a fibre product in  $\mathcal{C}$ .

**3.6. Tangent bundle.** We need to understand what is a tangent vector at a point  $p \in M$  to a space  $M$  equipped with a sheaf of functions. Everybody seems to ‘know’ what a tangent vector to a smooth surface  $M \subset \mathbb{K}^3$  is and can even draw it when  $\mathbb{K} = \mathbb{R}$ . Nevertheless, there are a couple of problems. The first consists in the words ‘smooth surface’ — we did not yet define a smooth subspace and the definition that first comes to mind tends to use the concept of a tangent vector itself ... The other problem is even more heavy. Our intuitive view on a tangent vector is in no way intrinsic. So, we have no clear idea on how to compare tangent vectors at the same point  $p \in M$  that come from different smooth embeddings  $M \hookrightarrow \mathbb{K}^n$ .

Fortunately, both problems can be solved with the same remedy. For the first, we can restrict the sheaf  $\mathcal{F}$  on  $\mathbb{K}^n$  to  $M$  and hope to characterize the smoothness of  $M$  in terms of  $\mathcal{F}|_M$ . Our basic example 3.3 provides a hint on how to manage the second problem. We can simply interpret an intuitive tangent vector  $v$  at  $p \in M$  as being a derivative in its direction. It is true that the expression  $f(p + \varepsilon v)$  makes no sense in terms of the sheaf  $\mathcal{F}|_M$ . However, it does make sense for small  $\varepsilon$  because the function  $f \in \mathcal{F}|_M$  is locally a restriction of some  $\hat{f} \in \mathcal{F}$ . At the first glance, it may seem that we can define  $v_p f := v_p \hat{f}$  even for a vector  $v$  that is not tangent to  $M$  at  $p \in M$ . But this will not work because the result  $v_p \hat{f}$  will depend on the extension  $\hat{f}$  of  $f$ . The independence of the choice of  $\hat{f}$  is exactly the tangency of  $v$  to  $M$  at a smooth point  $p \in M$ . Thus, we arrive at the following intrinsic definition.

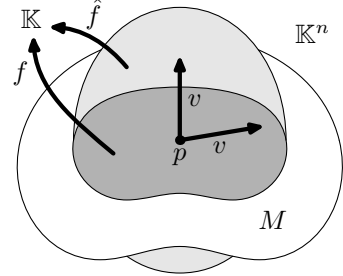

**3.6.1. Tangent vectors.** Let  $M$  be a space with a sheaf  $\mathcal{F}$  of  $\mathbb{K}$ -valued functions and let  $p \in M$ . A  $\mathbb{K}$ -linear functional  $t : \mathcal{F}_p \rightarrow \mathbb{K}$  is a *tangent vector* to  $M$  at  $p$  (in symbols,  $t \in T_p M$ ) if  $t$  is a derivation, i.e., if

$$t(g_1 g_2) = g_1(p) t g_2 + g_2(p) t g_1$$

for all  $g_1, g_2 \in \mathcal{F}_p$ .

Let  $p \in U \circlearrowleft M$ . Then  $(\mathcal{F}|_U)_p = \mathcal{F}_p$ . Therefore, assuming the induced structure on  $U$ , we obtain the identification  $T_p U = T_p M$ .

For  $p \in U \circlearrowleft M$ ,  $f \in \mathcal{F}(U)$ , and  $t \in T_p M$ , we define  $t f := t f_p$ .

**3.6.2. Exercise.** Let  $t \in T_p M$ . Show that  $t c = 0$  for every constant  $c \in \mathbb{K} \subset \mathcal{F}_p$  and that  $t(\mathfrak{m}_p^2) = 0$ . Hence,  $t$  defines a  $\mathbb{K}$ -linear functional  $\bar{t} : \mathfrak{m}_p / \mathfrak{m}_p^2 \rightarrow \mathbb{K}$ . Moreover, the  $\mathbb{K}$ -linear map  $T_p M \rightarrow (\mathfrak{m}_p / \mathfrak{m}_p^2)^*$ ,  $t \mapsto \bar{t}$ , is an isomorphism. By definition,  $T_p M$  and  $T_p^* M := \mathfrak{m}_p / \mathfrak{m}_p^2$  are the  $\mathbb{K}$ -linear spaces *tangent* and *cotangent* to  $M$  at  $p$ .

**3.6.3. Differential.** Let  $(M, \mathcal{F}) \xrightarrow{\psi} (N, \mathcal{G})$  be a smooth map and let  $p \in M$ . We have the homomorphism  $\mathcal{F}_p \xleftarrow{\psi_p^*} \mathcal{G}_{\psi(p)}$  of  $\mathbb{K}$ -algebras that is induced by the composition with  $\psi$ . Hence, we get the  $\mathbb{K}$ -linear map  $d\psi_p : T_p M \rightarrow T_{\psi(p)} N$  called the *differential* of  $\psi$  at  $p$ . At the level of functions, the differential is defined via composition with  $\psi$ , i.e.,  $d\psi_p t(f) := t(f \circ \psi)$  for  $f \in \mathcal{G}(U)$ ,  $\psi(p) \in U \subset N$ , and  $t \in T_p M$ .

We denote by  $TM := \bigsqcup_{p \in M} T_p M \xrightarrow{\pi} M$  the disjoint union (endowed with the obvious projection) of all tangent spaces to points in  $M$ . We call  $\pi : TM \rightarrow M$  the *tangent bundle* of  $M$ . Note that the *fibre*  $T_p M$  is nothing but  $\pi^{-1}(p)$ .

Given a smooth map  $(M, \mathcal{F}) \xrightarrow{\psi} (N, \mathcal{G})$ , we get the following commutative diagram, where the differential  $d\psi : T M \rightarrow T N$  equals  $d\psi_p$  on the fibre  $T_p M$ .

$$\begin{array}{ccc} T M & \xrightarrow{\quad} & T N \\ \downarrow \pi_M & \begin{array}{c} d\psi \\ \psi \end{array} & \downarrow \pi_N \\ M & \xrightarrow{\quad} & N \end{array}$$

**3.6.4. Exercise.** Show that  $T$  and  $d$  provide a *functor*, i.e., prove the following *chain rule*. Given smooth maps  $(L, \mathcal{E}) \xrightarrow{\varphi} (M, \mathcal{F}) \xrightarrow{\psi} (N, \mathcal{G})$ , the differential of the composition is the composition of the differentials:  $d(\psi \circ \varphi) = (d\psi) \circ (d\varphi)$ . (The fact that  $d1_M = 1_{T M}$  looks quite obvious.)

We can picture the tangent space  $T_p M$  as the best first order approximation of an infinitesimal neighbourhood of  $p \in M$  by a  $\mathbb{K}$ -linear space. So, the differential  $d\psi_p$  is the best first order linear approximation of  $\psi$  over such neighbourhood.

**3.6.5. Tangent bundle of a subspace.** Let  $S \subset M$  be a subspace, i.e., a subset equipped with the induced structure. We denote by  $IS$  all functions that vanish on  $S$ . In detail,  $IS(U) := \{f \in \mathcal{F}(U) \mid f(S \cap U) = 0\}$  for every  $U \subset M$ . We obtain the sheaf of ideals  $IS \triangleleft \mathcal{F}$  in the sense of the following definition.

Suppose that, for every  $U \subset M$ , we are given an ideal  $\mathcal{J}(U) \triangleleft \mathcal{F}(U)$ . We say that  $\mathcal{J} := \bigsqcup_{U \subset M} \mathcal{J}(U)$  is a *sheaf of ideals* in  $\mathcal{F}$  and write  $\mathcal{J} \triangleleft \mathcal{F}$  when the following conditions hold.

- If  $W \subset U \subset M$  and  $f \in \mathcal{J}(U)$ , then  $f|_W \in \mathcal{J}(W)$ .
- Let us be given open subsets  $U_i \subset M$ ,  $i \in I$ , and a function  $U \xrightarrow{f} \mathbb{K}$ , where  $U := \bigcup_{i \in I} U_i$ . If  $f|_{U_i} \in \mathcal{J}(U_i)$  for every  $i \in I$ , then  $f \in \mathcal{J}(U)$ .

The germs at  $p \in M$  of functions from  $\mathcal{J}$  form the *stalk*  $\mathcal{J}_p$  of  $\mathcal{J}$  at  $p$ . Clearly,  $\mathcal{J}_p \triangleleft \mathcal{F}_p$ .

**3.6.6. Exercise.** Let  $p \in S \subset M$ . Then  $(IS)_p \subset \mathfrak{m}_p$  and  $(\mathcal{F}|_S)_p = \mathcal{F}_p / (IS)_p$ .

**3.6.7. Exercise.** Let  $p \in S \subset M$ . Show that  $T_p S = \{t \in T_p M \mid t(IS)_p = 0\} \leq T_p M$ . This means that the differential of the inclusion  $i : S \hookrightarrow M$  can be interpreted as an inclusion  $di : T S \hookrightarrow T M$ .

**3.6.8. Equations.** Let  $(M, \mathcal{F})$  be a space with a sheaf of  $\mathbb{K}$ -valued functions. One may define a closed subspace  $S \subset M$  by means of equations. Say, we could take  $E \subset \mathcal{F}(M)$  and put  $S := \{p \in M \mid e(p) = 0 \text{ for all } e \in E\}$ . Unfortunately, there are many nice spaces with sheaves where such a definition produces nothing interesting.<sup>7</sup> The reason is simple — it can happen that  $\mathcal{F}(M) = \mathbb{K}$ . Let us try local functions in the equations:

Let  $E \subset \mathcal{F}$  and denote by  $U_e \subset M$  the domain of  $e \in E$ ,  $e \in \mathcal{F}(U_e)$ . We define the subspace

$$ZE := \{p \in M \mid e(p) = 0 \text{ for all } e \in E \text{ such that } p \in U_e\}$$

given by the *equations*  $E = 0$  and equipped with the induced structure. Note that, according to this definition,  $p \in ZE$  if  $p \notin U_e$  for all  $e \in E$ . In particular, every closed subset is given by equations. Indeed, let  $U \subset M$  and let  $1_U \in \mathbb{K} \subset \mathcal{F}(U)$  denotes the constant 1. Then  $M \setminus U = Z1_U$ .

We have  $ZE = \{p \in M \mid e_p \in \mathfrak{m}_p \text{ for all } e \in E \text{ such that } p \in U_e\}$ . In particular,  $Z\mathcal{J} = \{p \in M \mid \mathcal{J}_p \subset \mathfrak{m}_p\}$  for any sheaf of ideals  $\mathcal{J} \triangleleft \mathcal{F}$ .

**3.6.9. Exercise.** Let  $S \subset M$  and  $E \subset \mathcal{F}$ . Show that the operators  $Z$  and  $I$  revert the inclusion. Verify that  $ZIS \supset S$  and  $IZE \supset E$ . The sheaf of ideals  $IZE$  is the *saturation* of  $E \subset \mathcal{F}$ . Prove that the saturation  $IZE$  defines the same subspace as  $E$  does, i.e., that  $ZIZ = Z$ . Show that  $IS$  is *saturated*, i.e., that  $IZI = I$ .

In order to show that (conversely) any set given by equations is closed, we may require that the sheaf  $\mathcal{F}$  is local. A sheaf  $\mathcal{F}$  on  $M$  is *local* if every  $g \in \mathcal{F}_p \setminus \mathfrak{m}_p$  is *invertible* in  $\mathcal{F}_p$  for all  $p \in M$ . This means that there is some  $g' \in \mathcal{F}_p$  such that  $gg' = 1$ .

<sup>7</sup>Although, the definition works somehow for the sheaves  $C^\infty$ .

For every local sheaf  $\mathcal{F}$  and any  $E \subset \mathcal{F}$ , the set  $ZE$  is closed in  $M$ . Indeed, since  $ZE = \bigcap_{e \in E} Ze$ , it suffices to show that  $Ze$  is closed in  $M$ . Let  $e \in \mathcal{F}(U)$ . Then  $Ze = (M \setminus U) \cup \{p \in U \mid e_p \in \mathfrak{m}_p\}$ . It remains to prove that  $\{p \in U \mid e_p \notin \mathfrak{m}_p\} \subset \circ U$ . Let  $p \in U$  and  $e_p \notin \mathfrak{m}_p$ . Being  $\mathcal{F}$  local, we have  $e_p f_p = 1$  for suitable  $p \in V \subset \circ M$  and  $f \in \mathcal{F}(V)$ . By the definition of germs, there exists some  $W \subset \circ U \cap V$  such that  $p \in W$  and  $e|_W f|_W = 1$ . Hence,  $e_q f_q = 1$  for every  $q \in W$ . In other words,  $W \subset \{q \in U \mid e_q \notin \mathfrak{m}_q\}$ .

Moreover, the above arguments show that the function  $\frac{1}{e} : (M \setminus Ze) \rightarrow \mathbb{K}$  defined by the rule  $p \mapsto \frac{1}{e(p)}$  belongs locally to  $\mathcal{F}$ . So,  $\frac{1}{e} \in \mathcal{F}(M \setminus Ze)$  for every  $e \in \mathcal{F}$ . We arrive at another definition of a local sheaf: a sheaf  $\mathcal{F}$  is local iff, for every  $e \in \mathcal{F}$ , the locus where  $e$  does not vanish is open and the corresponding function  $\frac{1}{e}$  defined on this locus belongs to  $\mathcal{F}$ .

In an arbitrary sheaf, we can sum and multiply a couple of functions (over a locus where both are defined). In a local sheaf, we can also perform division. Hence, it makes sense to learn how to differentiate a fraction; by the Leibniz rule,  $t \frac{1}{g} = -\frac{tg}{g^2(p)}$  for all  $t \in T_p M$  and  $g \in \mathcal{F}_p \setminus \mathfrak{m}_p$ .

By Exercise 3.6.6, the sheaf  $\mathcal{F}|_S$  is local for every subspace  $S \subset M$  if  $\mathcal{F}$  is local.

**3.6.10. Taylor sheaves.** Suppose that every finite-dimensional  $\mathbb{K}$ -linear space  $V$  is equipped with a topology and a local sheaf  $\mathcal{F}^V$  of  $\mathbb{K}$ -valued functions such that the following conditions are satisfied.

- The topology on  $V$  is the weakest one such that all  $\mathcal{F}^V(V) \ni f : V \rightarrow \mathbb{K}$  are continuous.
- $V^* \subset \mathcal{F}^V(V)$ .
- Let  $V, W$  be finite-dimensional  $\mathbb{K}$ -linear spaces. A map  $V \circ \supset U \xrightarrow{\psi} W$  is smooth iff  $W^* \circ \psi \subset \mathcal{F}^V(U)$ .
- The composition  $V^* \rightarrow \mathfrak{m}_p \rightarrow \mathfrak{m}_p/\mathfrak{m}_p^2$  is a  $\mathbb{K}$ -linear isomorphism for every  $p \in V$ , where the map  $V^* \rightarrow \mathfrak{m}_p$  is given by the rule  $\varphi \mapsto \varphi_p - \varphi p \in \mathfrak{m}_p$ .

The last condition provides the identification  $T_p V \xrightarrow{\sim} V^{**} \simeq V$  given by the rule  $t \mapsto (v^* \mapsto tv^*)$ , where  $v^* \in V^*$ . It is nothing but Taylor's formula! Indeed, let  $p \in U \subset \circ V$  and let  $f \in \mathcal{F}^V(U)$ . Then  $f_p - f(p) \in \mathfrak{m}_p$ . So, there exist a unique  $\varphi \in V^*$  and  $h \in \mathfrak{m}_p^2$  such that  $f_p = f(p) + \varphi_p - \varphi p + h$ .

In Taylor's formula,  $\varphi$  provides the best linear approximation of  $f$  at  $p$  modulo a term of order 2. Hence, it is no surprise that  $df_p v = \varphi v$  in terms of the above identification. Indeed, the vector  $v \in V$  corresponds to the tangent vector  $t \in T_p U = T_p V$  such that  $v^* v = tv^*$  for all  $v^* \in V^*$ . By definition,  $df_p t : g \mapsto t(g \circ f)$  for all  $g \in \mathcal{F}^{\mathbb{K}}(W)$  such that  $f(p) \in W \subset \circ \mathbb{K}$ . Consequently,  $df_p v = df_p t \in T_{f(p)} \mathbb{K}$  corresponds to  $k \in \mathbb{K}$  such that  $k^* k = t(k^* \circ f)$  for all  $k^* \in \mathbb{K}^* = \mathbb{K}$ . Since  $k^* \circ f = k^* f$ , we obtain  $k^* k = k^* t(f_p) = k^* t(f(p) + \varphi_p - \varphi p + h) = k^* t \varphi_p = k^* \varphi v$ , implying  $k = \varphi v$ .

Let  $V$  be a finite-dimensional  $\mathbb{K}$ -linear space. Then the projection  $\pi : V \oplus V \rightarrow V$  is smooth by the third and second conditions. In particular,  $U \times V = \pi^{-1}(U) \subset \circ (V \oplus V)$  for every  $U \subset \circ V$ . Finally, we require that the differential  $df_p$  of a function depends smoothly on  $p$ :

- Let  $U \subset \circ V$  and let  $f \in \mathcal{F}^V(U)$ . Then the function  $d'f : U \times V \rightarrow \mathbb{K}$  given by the rule  $d'f : (p, v) \mapsto df_p v$  belongs to  $\mathcal{F}^{V \oplus V}(U \times V)$ .

Sheaves  $\mathcal{F}^V$  satisfying these five conditions are called *Taylor sheaves*.

There are several Taylor sheaves dealt with in geometry. The smallest ones are formed by algebraic functions (and assume the Zariski topology; such a topology is provided by the finite topology on  $\mathbb{K}$ , i.e., the weakest one with closed points). Another example is the sheaves of analytic functions.

Here, we are interested mostly in the large sheaves  $C^\infty$  of smooth functions. Since  $[v]_V \varphi$  is a constant (equal to  $\varphi v$ ) for any  $\varphi \in V^*$ , we obtain the second condition for the sheaves  $C^\infty$ . Exercises 3.3.4, 3.3.5, 3.3.3, and the solution of Exercise 3.3.3 suggested in Hints imply respectively the first, third, fourth, and fifth conditions. It is worthwhile mentioning that the first three conditions are valid for the sheaves  $C^k$ ,  $k \geq 0$ .



**3.6.11. Prevarieties.** This is a crucial subsection in this section. We want to introduce a convenient class  $\widehat{\mathcal{V}}$  of spaces with sheaves, mostly by means of certain local properties. In other words, every space in  $\widehat{\mathcal{V}}$  is a gluing of some basic spaces called *models*. The models come from finite-dimensional  $\mathbb{K}$ -linear spaces equipped with certain structures.

Given Taylor sheaves  $\mathcal{F}^V$ , a space  $M$  with a sheaf of  $\mathbb{K}$ -valued functions is called a *prevariety* if, locally, it is a locally closed<sup>8</sup> subspace in a finite-dimensional  $\mathbb{K}$ -linear space. Usually, the topology chosen on finite-dimensional linear spaces has a countable basis. In order to keep this property for prevarieties, one allows only countable or finite gluings of models (in the algebraic case, always finite).

We denote by  $\widehat{\mathcal{V}}$  the class of all prevarieties. The sheaves on prevarieties are obviously local. It follows directly from the above definition that  $\widehat{\mathcal{V}}$  is closed with respect to taking locally closed subspaces — called *subprevarieties* — and (countable or finite) gluings. A closed/open subspace in a prevariety is called a *closed/open subprevariety*. The intersection of finitely many (closed/open) subprevarieties is a (closed/open) subprevariety. Let  $(M, \mathcal{F}) \xrightarrow{\psi} (N, \mathcal{G})$  be a smooth map between prevarieties and let  $S \subset N$  be a (closed/open) subprevariety. Then  $\psi^{-1}(S)$  is a (closed/open) subprevariety in  $M$ .

**3.6.12. Exercise.** Let  $M \in \widehat{\mathcal{V}}$  be a prevariety and let  $U \subset \circ M$ . Prove that  $\mathcal{F}^M(U)$  consists of all smooth maps  $U \rightarrow \mathbb{K}$ .

**3.6.13. Lemma.** For all  $M, N \in \widehat{\mathcal{V}}$ , there exists a  $\widehat{\mathcal{V}}$ -product structure on  $M \times N$ .

**Proof.** By Exercises 3.5.4 and 3.5.3, it suffices to show that there exists a  $\widehat{\mathcal{V}}$ -product structure on  $V_1 \times V_2$ , where the  $V_i$ 's are finite-dimensional linear spaces. The projection  $V_1 \oplus V_2 \rightarrow V_i$  is smooth by the third condition in 3.6.10. Let  $M \in \widehat{\mathcal{V}}$  and let  $\psi_i : M \rightarrow V_i$  be smooth for  $i = 1, 2$ . We need to show that the corresponding map  $\psi : M \rightarrow V_1 \oplus V_2$  is smooth. By Exercise 3.4.1, we can assume that  $M$  is a model, i.e.,  $M \subset U \subset \circ V$ , where  $V$  is a finite-dimensional linear space.

Let  $v_{ij}^* \in V_i^*$  be a linear basis in  $V_i^*$ ,  $i = 1, 2$ . Then  $f_{ij} := v_{ij}^* \circ \psi_i \in \mathcal{F}^M(M)$  by the second condition in 3.6.10. Every function from  $\mathcal{F}^M(M)$  is locally a restriction of a function from  $\mathcal{F}^U$ . Without loss of generality, we can therefore assume (using again Exercise 3.4.1) that  $f_{ij} = \hat{f}_{ij}|_M$  for all  $i, j$ , where  $\hat{f}_{ij} \in \mathcal{F}^U(U)$ . There exists a unique map  $\hat{\psi}_i : U \rightarrow V_i$  such that  $v_{ij}^* \circ \hat{\psi}_i = \hat{f}_{ij}$  for all  $j$ . By the third condition in 3.6.10,  $\hat{\psi}_i$  is smooth. Obviously,  $\psi_i = \hat{\psi}_i|_M$ . So, we reduced the task to the case of  $M = U$ . In this case, the desired fact follows immediately from the second and third conditions in 3.6.10 ■

We denote by  $\Delta_B := \{(p, p) \mid p \in B\} \subset B \times B$  the *diagonal* in  $B \times B$ . (Actually,  $\Delta_B = B \times_B B$  with respect to the identity maps  $B \xrightarrow{1_B} B \xleftarrow{1_B} B$ .)

**3.6.14. Lemma.** Let  $M_1, M_2, B \in \widehat{\mathcal{V}}$  and let  $M_1 \xrightarrow{\varphi_1} B \xleftarrow{\varphi_2} M_2$  be smooth maps. Then the diagonal  $\Delta_B$  is locally closed in  $B \times B$ . If  $B \subset V$  is a model, i.e., a subprevariety in a finite-dimensional  $\mathbb{K}$ -linear space  $V$ , then  $\Delta_B$  is closed in  $B \times B$ . There exists a fibre product  $\widehat{\mathcal{V}}$ -structure on  $M_1 \times_B M_2$ .

**Proof.** The second statement follows from  $\Delta_B = \Delta_V \cap (B \times B)$  and from  $\Delta_V = Z_{V \times V} \{v^* \circ \pi_1 - v^* \circ \pi_2 \mid v^* \in V^*\}$ , where  $\pi_i : V \times V \rightarrow V$  stand for the projections.

For the first statement, we observe that  $\Delta_B \cap (B_i \times B_i) = \Delta_{B_i}$  is closed in  $B_i \times B_i$  by the second statement, where  $B = \bigcup_{i \in I} B_i$  is a gluing of models  $B_i \subset \circ B$ ,  $i \in I$ . Therefore,  $\Delta_B$  is closed in

$$\bigcup_{i \in I} (B_i \times B_i) \subset \circ B \times B.$$

For the third statement, by Lemma 3.6.13 and Exercise 3.5.7, it suffices to show that  $M_1 \times_B M_2$  is locally closed in  $M_1 \times M_2$ . Since  $\Delta_B$  is locally closed in  $B \times B$  by the first statement, it remains to observe that  $M_1 \times_B M_2 = (\psi_1 \times \psi_2)^{-1}(\Delta_B)$ , where the map  $\psi_1 \times \psi_2 : M_1 \times M_2 \rightarrow B \times B$  in the commutative diagram is smooth by the properties of the  $\widehat{\mathcal{V}}$ -product  $B \times B$  ■

$$\begin{array}{ccccc} M_1 & \longleftarrow & M_1 \times M_2 & \longrightarrow & M_2 \\ \downarrow \psi_1 & & \downarrow \psi_1 \times \psi_2 & & \downarrow \psi_2 \\ B & \longleftarrow & B \times B & \longrightarrow & B \end{array}$$

<sup>8</sup>A subspace  $S$  in a topological space  $M$  is *locally closed* if  $S = U \cap X$ , where  $X$  is closed in  $M$  and  $U \subset \circ M$ .

We are going to prove that the differential is a smooth map. First, we need to introduce a smooth structure on the tangent bundle.

Let  $M$  be a model. So,  $M \subset U$  is a closed subprevariety in an open subprevariety  $U \subset V$  in a finite-dimensional  $\mathbb{K}$ -linear space  $V$ . We have the canonical projection  $\pi_U : TU \rightarrow U$ . The isomorphisms  $T_p U = T_p V \simeq V$ ,  $p \in U$ , provide the other projection  $\pi' : TU \rightarrow V^{**} \simeq V$  given by the rule  $t \mapsto (v^* \mapsto tv^*)$ , where  $v^* \in V^*$ . Using the projections  $\pi_U, \pi'$ , we get an identification  $TU \simeq U \times V$ , i.e., a *trivialization* of the tangent bundle over  $U$ . At the level of fibres, this identification is an isomorphism of  $\mathbb{K}$ -linear spaces. Since  $U \times V \subset V \oplus V$  is an open subprevariety, we obtain the induced structure on  $TM \subset TU \simeq U \times V$  and a smooth projection  $\pi_M : TM \rightarrow M$ . By Exercise 3.6.7 and the fifth condition in 3.6.10,

$$\begin{array}{ccc} TU & \xrightarrow{\simeq} & U \times V \\ \pi_U \searrow & & \swarrow \\ & & U \end{array}$$

$$TM = Z_{U \times V}(IM \circ \pi_U) \cap Z_{U \times V}\{d'f \in \mathcal{F}^{V \oplus V}(W \times V) \mid f \in IM(W), W \subset V\}$$

is given by equations; hence,  $TM$  is closed in  $TU$  and all maps in the commutative diagram are smooth. In other words, the structure on  $TM$  is induced from  $TV = V \times V$  with respect to the imbedding  $M \hookrightarrow V$ .

$$\begin{array}{ccc} TM & \rightarrow & TU \\ \pi_M \downarrow & & \downarrow \pi_U \\ M & \rightarrow & U \end{array}$$

**3.6.15. Lemma.** *Let  $M_i \subset U_i$  be a closed subprevariety, where  $U_i \subset V_i$  is open in a finite-dimensional linear space  $V_i$ , and let  $TM_i$  be equipped with the structure induced from  $TV_i = V_i \times V_i$ ,  $i = 1, 2$ . Then, for every smooth map  $\psi : M_1 \rightarrow M_2$ , the differential  $d\psi : TM_1 \rightarrow TM_2$  is smooth.*

**Proof.** We can assume that  $M_2 = V_2$ . Let  $v_j^* \in V_2^*$  be a linear basis. The functions  $v_j^* \circ \psi \in \mathcal{F}^{M_1}(M_1)$  are locally restrictions of some functions  $f_j \in \mathcal{F}^{U_1}$ . By Exercise 3.4.1, we can assume that  $f_j \in \mathcal{F}^{U_1}(U_1)$ . There exists a unique map  $\hat{\psi} : U_1 \rightarrow V_2$  such that  $v_j^* \circ \hat{\psi} = f_j$  for all  $j$ . In other words,  $\psi = \hat{\psi}|_{M_1}$ . By the third condition in 3.6.10,  $\hat{\psi}$  is smooth. So, we can take  $M_1 = U_1$ .

By the properties of the  $\widehat{V}$ -product  $V_2 \times V_2$ , it suffices to show that  $\pi' \circ d\psi : TU_1 \rightarrow V_2$  is smooth because  $\pi_{V_2} \circ d\psi = \psi \circ \pi_{U_1}$  is smooth. By the third condition in 3.6.10, we need only to verify that  $v^* \circ \pi' \circ d\psi \in \mathcal{F}^{U_1 \times V_1}(U_1 \times V_1)$  for every  $v^* \in V_2^*$ . Hence, by the fifth condition in 3.6.10, it remains to check that  $v^* \circ \pi' \circ d\psi = d'f$ , where  $f := v^* \circ \psi \in \mathcal{F}^{U_1}(U_1)$ .

$$\begin{array}{ccccc} TU_1 & \xrightarrow{d\psi} & V_2 \times V_2 & \xrightarrow{\pi'} & V_2 \\ \pi_{U_1} \downarrow & & \downarrow \pi_{V_2} & & \downarrow v^* \\ U_1 & \xrightarrow{\psi} & V_2 & & \mathbb{K} \end{array}$$

Let  $p \in U_1$ , let  $t \in T_p U_1$ , and let  $v \in V_1$ ,  $v' \in V_2$  be the vectors corresponding to  $t, d\psi t$ . This means that  $t\varphi = \varphi v$  for all  $\varphi \in V_1^*$ , that  $\pi'(d\psi t) = v'$ , and that  $(d\psi t)v^* = v^*v'$ . By the fourth condition in 3.6.10, we have  $f_p = f(p) + \varphi_p - \varphi(p) + h$  with  $h \in \mathfrak{m}_p^2 \subset \mathcal{F}_p^{U_1}$  and  $\varphi \in V_1^*$ . Consequently,

$$d'f(p, v) = df_p v = \varphi v = t\varphi = tf = t(v^* \circ \psi) = (d\psi t)v^* = v^*v' = v^*(\pi'(d\psi t)) = (v^* \circ \pi' \circ d\psi)t \blacksquare$$

Taking  $M_1 := M_2 := M$  and  $\psi := 1_M$  in Lemma 3.6.15, we can see that the induced structure on  $TM \subset TV$  is independent of the choice of an embedding  $M \hookrightarrow V$  into a linear space.

Let  $M$  be an arbitrary prevariety. It is a gluing of models  $M = \bigcup_{i \in I} M_i$ . By Exercise 3.4.2, we can introduce a structure on  $TM$  as a gluing of the structures on  $TM_i \subset TM$  because the structures on  $T(M_i \cap M_j)$  induced from  $TM_i$  and from  $TM_j$  are the same by Lemma 3.6.15. A similar argument shows that the structure constructed on  $TM$  is independent of the choice of a gluing  $M = \bigcup_{i \in I} M_i$ . By Exercise 3.4.1 and Lemma 3.6.15, the differential  $d\psi$  of a smooth map  $\psi : M_1 \rightarrow M_2$  between prevarieties is a smooth map.

**3.6.16. Exercise.** Let  $M \in \widehat{\mathcal{V}}$  be a prevariety. Show that the maps  $TM \times_M TM \xrightarrow{+} TM$ ,  $(t_1, t_2) \mapsto t_1 + t_2$ , and  $\mathbb{K} \times TM \xrightarrow{\cdot} TM$ ,  $(k, t) \mapsto kt$ , are smooth. In words, the operations  $+$  and  $\cdot$  are smooth on the tangent bundle (where defined).

**3.7.  $C^\infty$ -manifolds.** Let  $M$  be a hausdorff topological space equipped with a sheaf of  $\mathbb{K}$ -valued  $C^\infty$ -functions and possessing a countable basis of topology. We say that  $M$  is a  $C^\infty$ -*manifold* (or simply a *manifold*) if, locally, it is an open subvariety in a finite-dimensional  $\mathbb{K}$ -linear space.

Let  $T_1, T_2$  be topological spaces. The weakest topology on  $T_1 \times T_2$  with continuous projections  $\pi_i : T_1 \times T_2 \rightarrow T_i$  is called the *product* topology. We must warn the reader that the topology introduced in Subsections 3.5 and 3.6.11 on  $\widehat{\mathcal{V}}$ -products may be stronger than the product topology as it happens, for instance, in the case of the sheaves of algebraic functions. However, for the sheaves  $C^\infty$ , these topologies coincide by Exercise 3.3.4.

**3.7.1. Exercise.** Show that a topological space  $T$  is hausdorff iff the diagonal  $\Delta_T$  is closed in the space  $T \times T$  equipped with the product topology.

**3.7.2. Families and bundles.** Let  $\pi_i : T_i \rightarrow B$  be smooth maps between prevarieties  $T_i, B \in \widehat{\mathcal{V}}$ ,  $i = 1, 2$ . We can interpret  $\pi_i$  as a *family* of spaces  $\pi_i^{-1}(p)$ , called *fibres*, parameterized by  $p \in B$ . A *morphism* between such families is a smooth map  $\psi : T_1 \rightarrow T_2$  such that  $\pi_2 \circ \psi = \pi_1$ . Obviously, the composition of morphisms is a morphism and the identity map is a morphism. An invertible morphism (= possessing a two-side inverse) is an *isomorphism*.

Let  $F, B \in \widehat{\mathcal{V}}$  be prevarieties. A *trivial (fibre) bundle* over  $B$  is a family of subspaces  $\pi : T \rightarrow B$  isomorphic to the trivial family  $F \times B \rightarrow B$ . In other words, a trivial bundle is a product that has forgotten one of its projections. A family of subspaces  $\pi : T \rightarrow B$  is a *(fibre) bundle* if it is *locally trivial*, i.e., if there exists an open cover of the *base*  $B = \bigcup_{i \in I} B_i$ , called a *trivializing cover*, such that

$\pi^{-1}(B_i) \rightarrow B_i$  is a trivial bundle for all  $i \in I$ . It is immediate that a bundle over a manifold whose fibres are manifolds is a manifold. As we have seen in Subsection 3.6.11, the tangent bundle  $\pi : TM \rightarrow M$  of any manifold  $M$  is a bundle. However, in general, the tangent bundle of a prevariety is not a bundle!<sup>9</sup> A bundle with discrete fibres is called a *(regular) covering*. Coverings are essential when studying manifolds that carry a geometrical structure (see Section 5). The reader can see the picture of a simple covering at the very beginning of Section 2.

**3.7.3. Exercise.** Prove that the sphere and the projective space are compact manifolds.

**3.7.4A. Example.** More generally, prove that the grassmannians  $\text{Gr}_{\mathbb{K}}(k, V)$  and  $\text{Gr}_{\mathbb{R}}^+(k, V)$  are compact manifolds (see 2.12A and 3.4.4A).

**3.7.5. Exercise.** Let  $V$  be a finite-dimensional  $\mathbb{K}$ -linear space. Show that

$$T := \{(l, v) \mid V \geq l \ni v, \dim_{\mathbb{K}} l = 1\} \subset \mathbb{P}_{\mathbb{K}}V \times V$$

is a closed submanifold and that the projection to  $\mathbb{P}_{\mathbb{K}}V$  provides a bundle  $\pi : T \rightarrow \mathbb{P}_{\mathbb{K}}V$ . This bundle is called *tautological*. Visualize  $T$  as a Möbius band in the case of  $\dim_{\mathbb{R}} V = 1$ . Is every tautological bundle trivial?

**3.7.6A. Exercise.** More generally, formulate and solve a similar exercise about grassmannians.

**3.7.7. Exercise.** Prove that the surface of a 3-cube in  $\mathbb{R}^3$  is not a  $C^\infty$ -manifold.

**3.7.8. Tangent vector to a curve.** A smooth map  $\mathbb{R} \circlearrowright (a, b) \xrightarrow{c} M$  into a  $C^\infty$ -prevariety  $(M, \mathcal{F})$  is a *parameterized smooth curve*. The *tangent vector*  $\dot{c}(t_0)$  to the curve  $c$  at the point  $c(t_0)$  is given by the formula  $\mathcal{F}_{c(t_0)} \ni f_{c(t_0)} \mapsto \left. \frac{d}{dt} \right|_{t=t_0} f(c(t))$ . It is easy to see that every tangent vector to a manifold is tangent to a suitable smooth curve.

**3.7.9. Exercise.** Translate any book on basic differential topology (the worst is the best) into the terms of the above exposition.

---

<sup>9</sup>For the sheaves  $C^\infty$ , the tangent bundle of a prevariety which is not a manifold can be a bundle (take, for example, a closed ball). In the case of algebraic geometry, the tangent bundle of a prevariety is rarely a bundle. This happens, say, when the prevariety is smooth and rational.

**3.8A. Final remarks.** It is important to study not only smooth manifolds but also manifolds with singularities (analytic spaces in the case of analytic sheaves). Such hausdorff spaces — let us call them *varieties* — should be defined by means of models  $M \subset U \subset \circ V$  whose sheaf  $\mathcal{I}M$  of ideals satisfies certain finiteness conditions. In this case, our considerations in 3.6.11–16 should work for varieties.

There are indications that a right definition of a smooth space should be close to the one mentioned in Remark 3.8.1A below. However, if we were to simply accept it, we would not have had the above journey around the world of smooth spaces.

**3.8.1A. Remark.** Let  $(M, \mathcal{F}^M)$  and  $(T^*, \mathcal{F}^{T^*})$  be spaces with sheaves of  $\mathbb{K}$ -valued functions and let  $\pi : T^* \rightarrow M$  be a smooth map whose fibres are finite-dimensional  $\mathbb{K}$ -linear spaces such that the global operations  $+$  :  $T^* \times_M T^* \rightarrow T^*$  and  $\cdot$  :  $\mathbb{K} \times T^* \rightarrow T^*$  are smooth. It seems possible to define varieties in these terms by using a de Rham morphism of the sheaves  $d : \mathcal{F}^M \rightarrow \mathcal{T}^*$  subject to a Leibniz rule, where  $\mathcal{T}^*$  stands for the sheaf of smooth sections of  $\pi : T^* \rightarrow M$ .

#### 4. Elementary geometry

*there were and are even now geometers and philosophers  
... who doubt that the whole universe ... was created  
purely in accordance with Euclidean geometry*

— FYODOR DOSTOYEVSKY, *The Karamazov brothers*

*Out of nothing I have created a strange new universe.*

— JÁNOS BOLYAI

For a long time, there was little doubt that Euclidean geometry is the ‘right’ geometry; nowadays, non-Euclidean geometry is involved in many areas of mathematics and physics. It is no exaggeration to say that the discovery of non-Euclidean geometry, more specifically of hyperbolic geometry, represented a major mathematical and philosophical breakthrough. The ancient question concerning the fifth postulate<sup>10</sup> was finally answered, and the answer was astonishing: the apparently evident fifth postulate turned out to be *independent* since hyperbolic and Euclidean geometries share the same axioms except the fifth one (which is false in the hyperbolic plane). Of course, we are not interested in axiomatic geometry here. Instead, we study hyperbolic and many other non-Euclidean geometries on the basis of simple linear algebra. In this regard, the reader is welcome to consult Section 6 devoted to linear and hermitian tools.

**4.1. Some notation.** Let  $V$  be a finite-dimensional  $\mathbb{K}$ -linear space equipped with a nondegenerate hermitian form  $\langle -, - \rangle$ , where  $\mathbb{K} = \mathbb{R}$  or  $\mathbb{K} = \mathbb{C}$ . Depending on the context, we will frequently use a same letter to denote a point in  $\mathbb{P}_{\mathbb{K}}V$  and a representative in  $V$ . We use the notation and convention for projectivizations introduced in Subsection 2.6 : given a subset  $S \subset V$ , the image of  $S$  under the quotient map  $\pi : V \rightarrow \mathbb{P}_{\mathbb{K}}V$  is denoted by  $\mathbb{P}_{\mathbb{K}}S := \pi(S \setminus \{0\}) \subset \mathbb{P}_{\mathbb{K}}V$ .

The *signature* of  $p \in \mathbb{P}_{\mathbb{K}}V$  is the sign of  $\langle p, p \rangle$  (it can be  $-$ ,  $+$ , or  $0$ ). Note that signature is well defined since, for another representative  $kp \in V$ ,  $k \in \mathbb{K}^*$ , we have  $\langle kp, kp \rangle = |k|^2 \langle p, p \rangle$ . The projective space  $\mathbb{P}_{\mathbb{K}}V$  is divided into three disjoint parts consisting of *negative*, *positive*, and *isotropic* points:

$$BV := \{p \in \mathbb{P}_{\mathbb{K}}V \mid \langle p, p \rangle < 0\}, \quad EV := \{p \in \mathbb{P}_{\mathbb{K}}V \mid \langle p, p \rangle > 0\}, \quad SV := \{p \in \mathbb{P}_{\mathbb{K}}V \mid \langle p, p \rangle = 0\}.$$

The isotropic points constitute the *absolute*  $SV$  of  $\mathbb{P}_{\mathbb{K}}V$ . The absolute is a ‘wall’ separating the geometries (not yet introduced) on  $BV$  and  $EV$ . Moreover, we will see later that the absolute itself possesses its own geometry. We denote  $\overline{BV} := BV \sqcup SV$  and  $\overline{EV} := EV \sqcup SV$ .

---

<sup>10</sup>Roughly speaking, the postulate says: given a point and a line, there exists a unique parallel line passing through the point.

Let  $p \in \mathbb{P}_{\mathbb{K}}V$  be nonisotropic. We introduce the following notation for the orthogonal decomposition:

$$V = \mathbb{K}p \oplus p^{\perp}, \quad v = \pi'[p]v + \pi[p]v,$$

where

$$\pi'[p]v := \frac{\langle v, p \rangle}{\langle p, p \rangle} p \in \mathbb{K}p, \quad \pi[p]v := v - \frac{\langle v, p \rangle}{\langle p, p \rangle} p \in p^{\perp}.$$

It is easy to see that  $\pi'[p]$  and  $\pi[p]$  do not depend on the choice of a representative  $p \in V$ .

**4.2. Tangent space.** Let  $p \in \mathbb{P}_{\mathbb{K}}V$ , let  $f$  be a smooth function defined on an open neighbourhood  $U \subset \mathbb{P}_{\mathbb{K}}V$  of  $p$ , and let  $\varphi : \mathbb{K}p \rightarrow V$  be a  $\mathbb{K}$ -linear map. Using the notation from Subsection 3.3, we define

$$t_{\varphi}f := (\varphi p)_p \tilde{f},$$

where  $\tilde{f}$  stands for the lift of  $f$  to an open neighbourhood of  $\mathbb{K} \cdot p$  in  $V$ . This lift satisfies  $\tilde{f}(kp) = \tilde{f}(p)$  for all  $k \in \mathbb{K}^*$ .

**4.2.1. Exercise.** Verify that  $t_{\varphi}$  is well defined and conclude that  $t_{\varphi} \in T_p \mathbb{P}_{\mathbb{K}}V$ . Show that  $t_{\varphi} = 0$  iff  $\varphi p \in \mathbb{K}p$ . Therefore,  $T_p \mathbb{P}_{\mathbb{K}}V = \text{Lin}_{\mathbb{K}}(\mathbb{K}p, V/\mathbb{K}p)$ . For a nonisotropic  $p \in \mathbb{P}_{\mathbb{K}}V$ , we have the identifications  $T_p \mathbb{P}_{\mathbb{K}}V = \text{Lin}_{\mathbb{K}}(\mathbb{K}p, p^{\perp}) = \langle -, p \rangle p^{\perp}$ , where  $\langle -, p \rangle v : x \mapsto \langle x, p \rangle v$ .

Intuitively, we can interpret the identification  $T_p \mathbb{P}_{\mathbb{K}}V = \text{Lin}_{\mathbb{K}}(\mathbb{K}p, p^{\perp})$  as follows. A point  $p \in \mathbb{P}_{\mathbb{K}}V$  corresponds to a line  $L \subset V$  passing through 0. A tangent vector  $t_{\varphi}$  at  $p$  is an infinitesimal movement of  $L$  (a sort of rotation through 0) and so can be exhibited as a direction orthogonal to  $L$ . But this direction is not merely an element  $t_{\varphi}p \in p^{\perp}$ : the fact that  $t_{\varphi}$  is a linear map provides the independence of the choice of a representative  $p \in V$ .

The tangent vector to a smooth curve in  $\mathbb{P}_{\mathbb{K}}V$  at a nonisotropic  $p$  can be handy expressed in terms of the identification  $T_p \mathbb{P}_{\mathbb{K}}V = \text{Lin}_{\mathbb{K}}(\mathbb{K}p, p^{\perp})$ :

**4.2.2. Exercise.** Let  $c : (a, b) \rightarrow \mathbb{P}_{\mathbb{K}}V$  be a smooth curve, let  $c_0 : (a, b) \rightarrow V$  be a smooth lift of  $c$  to  $V$ , and let  $c(t)$  be a nonisotropic point,  $t \in (a, b)$ . Show that the tangent vector to  $c$  at  $c(t)$  corresponds to the  $\mathbb{K}$ -linear map  $\dot{c}(t) : \mathbb{K}c_0(t) \rightarrow c_0(t)^{\perp}$ ,  $c_0(t) \mapsto \pi[c_0(t)]\dot{c}_0(t)$ .

**4.2.3.\* Exercise.** Let  $W \leq V$  be an  $\mathbb{R}$ -linear subspace. A point  $p \in W$  is said to be *projectively smooth* if  $\dim_{\mathbb{R}}(\mathbb{K}p \cap W) = \min_{0 \neq w \in W} \dim_{\mathbb{R}}(\mathbb{K}w \cap W)$ . Prove that the projectivization  $\mathbb{P}_{\mathbb{K}}S \subset \mathbb{P}_{\mathbb{K}}V$  of the subset  $S \subset W$  formed by all projectively smooth points in  $W$  is a submanifold. Let  $p \in S$  be a projectively smooth point and let  $\varphi : \mathbb{K}p \rightarrow V$  be a  $\mathbb{K}$ -linear map. Show that  $t_{\varphi} \in T_p \mathbb{P}_{\mathbb{K}}S$  iff  $\varphi p \in W + \mathbb{K}p$ .

**4.3. Metric.** Let  $p \in \mathbb{P}_{\mathbb{K}}V$  be a nonisotropic point. Given  $v \in p^{\perp}$ , we define

$$t_{p,v} := \langle -, p \rangle v \in T_p \mathbb{P}_{\mathbb{K}}V.$$

Note that  $t_{p,v}$  does depend on the choice of a representative  $p \in V$ : If we pick a new representative  $\bar{k}p \in V$ ,  $\bar{k} \in \mathbb{K}^*$ , then we must take  $\frac{1}{\bar{k}}v \in V$  in place of  $v$  in order to keep  $t_{p,v}$  the same.

The tangent space  $T_p \mathbb{P}_{\mathbb{K}}V$  is equipped with the hermitian form

$$(4.3.1) \quad \langle t_{p,v_1}, t_{p,v_2} \rangle := \pm \langle p, p \rangle \langle v_1, v_2 \rangle.$$

This definition is correct as the formula is independent of the choice of representatives  $p, v_1, v_2 \in V$  providing the same  $t_{p,v_1}, t_{p,v_2}$ . One can readily see that this hermitian form, called a *hermitian metric* (or simply a *metric*), depends smoothly on a nonisotropic  $p$ . Actually, this is another instance of a

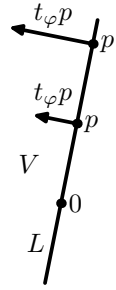

typical situation when we are to show some smooth dependence on a parameter. In general, such cases can be treated as in Exercise 3.6.16 and usually the concept of fibred product is to be explored. The only essential step in the proof consists in observing the (say) algebraic nature of the formulae involving the parameter.

What do we need a hermitian metric for?

**4.3.2. Length and angle.** Let  $M$  be a smooth manifold such that every tangent space  $T_p M$  is equipped with a positive-definite hermitian form  $\langle -, - \rangle$  depending smoothly on  $p$ . Then we can measure the length of a smooth curve  $c : [a, b] \rightarrow M$  by using the familiar formula

$$\ell c := \int_a^b \sqrt{\langle \dot{c}(t), \dot{c}(t) \rangle} dt,$$

where  $\dot{c}(t)$  stands for the tangent vector to  $c$  at  $c(t)$ .

We can also measure the nonoriented angle  $\alpha \in [0, \pi]$  between nonnull tangent vectors  $0 \neq t_1, t_2 \in T_p M$  by using the other familiar formula

$$\cos \alpha = \frac{\operatorname{Re}\langle t_1, t_2 \rangle}{\sqrt{\langle t_1, t_1 \rangle} \cdot \sqrt{\langle t_2, t_2 \rangle}}.$$

In the particular case when  $\mathbb{K} = \mathbb{C}$  and the real subspace  $\mathbb{R}t_1 + \mathbb{R}t_2 \leq T_p M$  is complex, the oriented angle  $\alpha \in [0, 2\pi)$  from  $t_1$  to  $t_2$  is given by  $\alpha = \operatorname{Arg}\langle t_2, t_1 \rangle$ .

In other words, a *hermitian metric* is what equips the manifold with a geometric structure.

**4.4. Examples.** By taking a particular field  $\mathbb{K}$  and a signature of the form  $\langle -, - \rangle$  on  $V$ , we get many examples of classic geometries.

- We take  $\mathbb{K} = \mathbb{C}$ ,  $\langle -, - \rangle$  of signature  $++$ , and the sign  $+$  in (4.3.1). The Riemann sphere  $\mathbb{P}_{\mathbb{C}}V$  becomes a *round* sphere. It looks just like the usual sphere (of radius  $\frac{1}{2}$ ) in Euclidean 3-dimensional space (see 4.5.4).

- We take  $\mathbb{K} = \mathbb{C}$ ,  $\langle -, - \rangle$  of signature  $-+$ , and the sign  $-$  in (4.3.1).

**4.4.1. Exercise.** Show that the Riemann sphere  $\mathbb{P}_{\mathbb{C}}V$  is formed by the closed discs  $\overline{BV}$  and  $\overline{EV}$  glued along the absolute  $SV$ . Note that the hermitian metric on  $T_p \mathbb{P}_{\mathbb{C}}V$  is positive-definite for all nonisotropic  $p$ .

Each of  $BV$  and  $EV$  is a *Poincaré* disc. It is endowed with the corresponding metric and constitutes the most famous model of plane *hyperbolic* geometry. We call  $\mathbb{P}_{\mathbb{C}}V$  the *Riemann-Poincaré* sphere.<sup>11</sup>

- We take  $\mathbb{K} = \mathbb{R}$ ,  $\langle -, - \rangle$  of signature  $-++$ , and the sign  $-$  in (4.3.1).

**4.4.2. Exercise.** Show that the real projective plane  $\mathbb{P}_{\mathbb{R}}V$  is formed by the closed disc  $\overline{BV}$  and Möbius band  $\overline{EV}$  glued along the absolute  $SV$ . Note that the metric on  $T_p \mathbb{P}_{\mathbb{R}}V$  is positive-definite for  $p \in BV$  and has signature  $-+$  for  $p \in EV$ .

The metric on the Möbius band  $EV$  is not positive-definite (it is called a *lorentzian* metric). In spite of this fact, the metric still equips  $EV$  with its adequate geometry. The fact that the concepts of length and angle do not work fairly in this case does not mean at all that the geometry has been lost (see Subsection 4.5.11).

The disc  $BV$  equipped with its metric is known as the *Beltrami-Klein* disc. It constitutes another model of plane hyperbolic geometry. It is easy to show (see Exercise 4.5.10) that the Beltrami-Klein disc and the Poincaré disc are essentially isometric. However, there is something fundamentally different

<sup>11</sup>We thank Pedro Walmsley Frejlich for suggesting this term.

about these two hyperbolic spaces: while the complement of a Poincaré disc in  $\mathbb{P}_{\mathbb{C}}V$  is another Poincaré disc, the complement of the Beltrami-Klein disc in  $\mathbb{P}_{\mathbb{R}}V$  is a lorentzian Möbius band . . . we will soon discover that there is more to the above sentence than just naming five great mathematicians.

- We take  $\mathbb{K} = \mathbb{C}$ ,  $\langle -, - \rangle$  of signature  $-++$ , and the sign  $-$  in (4.3.1). The open 4-ball  $BV \subset \mathbb{P}_{\mathbb{C}}V$  is the *complex hyperbolic plane*. We call the entire  $\mathbb{P}_{\mathbb{C}}V$  the *extended complex hyperbolic plane*. It is curious that all the above examples can be naturally embedded into the extended complex hyperbolic plane (see 4.7). Moreover, one can deform an embedded round sphere into a Riemann-Poincaré sphere . . . Which geometry should appear along the way of the deformation?

- We take  $\mathbb{K} = \mathbb{R}$ ,  $\langle -, - \rangle$  of signature  $-+++$ , and the sign  $-$  in (4.3.1). The open 3-ball  $BV \subset \mathbb{P}_{\mathbb{R}}V$  is the *real hyperbolic space*. The manifold  $EV$  — called the *de Sitter space* — is lorentzian, i.e., the signature of the metric on  $T_p EV$  is  $-++$  for all  $p \in EV$ . The de Sitter space is popular among physicists as they think it applies to general relativity.

- We take  $\mathbb{K} = \mathbb{C}$ ,  $\langle -, - \rangle$  of signature  $+\cdots+$ , and the sign  $+$  in (4.3.1). We get the projective space  $\mathbb{P}_{\mathbb{C}}V$  equipped with the positive-definite *Fubini-Study* metric. This metric is essential in many areas of mathematics and physics, including complex analysis and classical/quantum mechanics.

**4.5. Geodesics and tance.** Let  $W \leq V$  be a 2-dimensional  $\mathbb{R}$ -linear subspace such that the hermitian form, being restricted to  $W$ , is real and nonnull. We call  $\mathbb{P}_{\mathbb{K}}W \subset \mathbb{P}_{\mathbb{K}}V$  a *geodesic*.

**4.5.1. Exercise.** Show that  $\mathbb{K}p \cap W = \mathbb{R}p$  for all  $0 \neq p \in W$  and that  $\mathbb{P}_{\mathbb{K}}W = \mathbb{P}_{\mathbb{R}}W$ . Hence, every geodesic is topologically a circle. The geodesic  $\mathbb{P}_{\mathbb{K}}W$  spans its projective line  $\mathbb{P}_{\mathbb{K}}(\mathbb{K}W) \subset \mathbb{P}_{\mathbb{K}}V$ . The geodesics  $\mathbb{P}_{\mathbb{K}}W_1$  and  $\mathbb{P}_{\mathbb{K}}W_2$  are equal iff  $W_1 = kW_2$  for some  $k \in \mathbb{K}$ .

**4.5.2. Exercise.** Let  $\mathbb{P}_{\mathbb{K}}V$  be a projective line,  $\dim_{\mathbb{K}} V = 2$ . Given a nonisotropic  $p \in \mathbb{P}_{\mathbb{K}}V$ , there exists a unique  $q \in \mathbb{P}_{\mathbb{K}}V$  such that  $\langle p, q \rangle = 0$  (in words,  $q$  is orthogonal to  $p$ ). Let  $p_1, p_2 \in \mathbb{P}_{\mathbb{K}}V$  be distinct points. If  $p_1, p_2$  are nonorthogonal, then there exists a unique geodesic containing  $p_1, p_2$ . If  $\langle p_1, p_2 \rangle = 0$  and  $p_1$  is nonisotropic, then every geodesic in  $\mathbb{P}_{\mathbb{K}}V$  passing through  $p_1$  passes also through  $p_2$ .

**4.5.3. Exercise.** Let  $p \in \mathbb{P}_{\mathbb{K}}V$  be a nonisotropic point and let  $0 \neq t \in T_p \mathbb{P}_{\mathbb{K}}V$  be a nonnull tangent vector at  $p$ . Show that there exists a unique geodesic passing through  $p$  with tangent vector  $t$ . Let  $p_1, p_2 \in \mathbb{P}_{\mathbb{K}}V$  be distinct nonorthogonal points with nonisotropic  $p_1$  and let  $G$  be the geodesic that passes through  $p_1$  and  $p_2$ . We denote by  $q \in G$  the point orthogonal to  $p_1$ . Show that  $\langle -, p_1 \rangle \frac{\pi[p_1]p_2}{\langle p_2, p_1 \rangle}$  is a tangent vector at  $p_1$  to the oriented segment of geodesic from  $p_1$  to  $p_2$  not passing through  $q$ .

Let us calculate the length of geodesics. By Exercise 4.5.1, we can assume that  $\dim_{\mathbb{K}} V = 2$ .

**4.5.4. Spherical geodesics.** A geodesic  $\mathbb{P}_{\mathbb{K}}W$  is *spherical* if  $W$  has signature  $++$ . Such a geodesic spans the projective line  $\mathbb{P}_{\mathbb{K}}V$  with  $V$  of signature  $++$ . We will parameterize  $\mathbb{P}_{\mathbb{K}}W$ . Let  $p_1 \in W$ . We include  $p_1$  in an orthonormal basis  $p_1, q \in V$  with  $q \in W$ . The curve

$$c_0 : [0, a] \rightarrow V, \quad c_0(t) := p_1 \cos t + q \sin t, \quad a \geq 0$$

is a lift to  $V$  of a segment of geodesic  $c : [0, a] \rightarrow \mathbb{P}_{\mathbb{K}}V$  joining  $p_1 = c(0)$  and  $p_2 := c(a)$ . By Exercise 4.2.2, the tangent vector to  $c$  at  $c(t)$  equals

$$\dot{c}(t) = \langle -, c_0(t) \rangle \frac{\pi[c_0(t)]\dot{c}_0(t)}{\langle c_0(t), c_0(t) \rangle} = \langle -, c_0(t) \rangle \dot{c}_0(t)$$

because  $\langle c_0(t), c_0(t) \rangle = 1$  and  $\langle \dot{c}_0(t), c_0(t) \rangle = 0$  for all  $t \in [0, a]$ . Hence,  $\ell c = \int_0^a \sqrt{\langle \dot{c}(t), \dot{c}(t) \rangle} dt = \int_0^a dt = a$  (we take the sign  $+$  in (4.3.1)). If  $a \in [0, \frac{\pi}{2}]$ , then  $a$  can be expressed in terms of the *tance*

$$(4.5.5) \quad \text{ta}(p_1, p_2) := \frac{\langle p_1, p_2 \rangle \langle p_2, p_1 \rangle}{\langle p_1, p_1 \rangle \langle p_2, p_2 \rangle}.$$

By Sylvester's criterion,  $\text{ta}(p_1, p_2) \in [0, 1]$  with the extremal values corresponding to  $p_2 = q$  and  $p_2 = p_1$ . A direct calculation shows that  $\text{ta}(p_1, p_2) = \cos^2 a$ . Therefore,

$$\ell c = \arccos \sqrt{\text{ta}(p_1, p_2)}.$$

Let  $p_1, p_2 \in \mathbb{P}_{\mathbb{K}}W$  be distinct nonorthogonal points in a spherical geodesic. They divide the circle  $\mathbb{P}_{\mathbb{K}}W$  into two segments. The one that does not contain the point orthogonal (*antipodal*) to  $p_1$  is the *shortest* segment joining  $p_1$  and  $p_2$  and its length  $a < \frac{\pi}{2}$  is given by the above formula. When  $p_1, p_2$  are orthogonal, either segment has length  $\frac{\pi}{2}$ . This is why, in Examples 4.4, the round sphere has radius  $\frac{1}{2}$ .

**4.5.6. Hyperbolic geodesics.** A geodesic  $\mathbb{P}_{\mathbb{K}}W$  is *hyperbolic* if  $W$  has signature  $-+$ . Such a geodesic spans the projective line  $\mathbb{P}_{\mathbb{K}}V$  with  $V$  of signature  $-+$ . We will parameterize  $\mathbb{P}_{\mathbb{K}}W$ . Let  $p_1 \in W$  be nonisotropic. We include  $p_1$  in an orthonormal basis  $p_1, q \in V$  with  $q \in W$ . The curve

$$c_0 : [0, a] \rightarrow V, \quad c_0(t) := p_1 \cosh t + q \sinh t, \quad a \geq 0$$

is a lift to  $V$  of a segment of geodesic  $c : [0, a] \rightarrow \mathbb{P}_{\mathbb{K}}V$  joining  $p_1 = c(0)$  and  $p_2 := c(a)$ . (The hyperbolic functions are defined as  $\cosh t := \frac{e^t + e^{-t}}{2}$  and  $\sinh t := \frac{e^t - e^{-t}}{2}$ .) It is easy to see that  $\langle c_0(t), c_0(t) \rangle = \langle p_1, p_1 \rangle$  for all  $t \in [0, a]$ . So, the segment  $c$  contains no isotropic points. As above,  $\ell c = a$  (we take the sign  $-$  in (4.3.1)). By Sylvester's criterion,  $\text{ta}(p_1, p_2) \geq 1$  with the extremal value corresponding to  $p_2 = p_1$ . Hence,

$$\ell c = \text{arccosh} \sqrt{\text{ta}(p_1, p_2)}.$$

A hyperbolic geodesic contains exactly two isotropic points called *vertices*. They divide the geodesic into two parts; one is positive and the other, negative. The vertices can be treated as points at infinity.

**4.5.7. Triangle inequality.** We can use the above expressions and introduce distance functions in the parts of  $\mathbb{P}_{\mathbb{K}}V$  where the hermitian metric (4.3.1) is positive-definite: the *hyperbolic distance*  $d(p_1, p_2) := \text{arccosh} \sqrt{\text{ta}(p_1, p_2)}$  is a distance function in the real or complex hyperbolic geometries; the *spherical distance*  $d(p_1, p_2) := \arccos \sqrt{\text{ta}(p_1, p_2)}$  is a distance function in the Fubini-Study spaces.

These formulae are monotonic in tance. Therefore, it sounds like a good idea to use tance in place of distance because tance is a simple algebraic expression (involving just the hermitian form on  $V$  which is, after all, the source of the geometry on  $\mathbb{P}_{\mathbb{K}}V$ ). We know that distance is additive. Better to say, it is subject to the triangle inequality. Let us express this inequality in terms of tances.

We consider the real hyperbolic case. Take  $\mathbb{K} = \mathbb{R}$ ,  $\langle -, - \rangle$  of signature  $-+++$ , and the sign  $-$  in (4.3.1). Let  $p_1, p_2, p_3 \in BV$ . We fix representatives such that  $\langle p_i, p_i \rangle = -1$  and  $r_1, r_2 > 0$ , where  $r_i := -\langle p_i, p_{i+1} \rangle$  (the indices are modulo 3). By Sylvester's criterion,  $r_i^2 \geq 1$  and  $\det \begin{bmatrix} -1 & -r_1 & -r_3 \\ -r_1 & -1 & -r_2 \\ -r_3 & -r_2 & -1 \end{bmatrix} \leq 0$ . Hence,

$$(4.5.8) \quad r_1^2 + r_2^2 + r_3^2 \leq 2r_1r_2r_3 + 1,$$

implying  $r_3 \geq 1$ . The triangle inequality  $\text{arccosh} r_1 \leq \text{arccosh} r_2 + \text{arccosh} r_3$  is equivalent to

$$r_1 \leq \cosh(\text{arccosh} r_2 + \text{arccosh} r_3) = r_2r_3 + \sqrt{r_2^2 - 1}\sqrt{r_3^2 - 1}$$

(since  $\cosh(x + y) = \cosh x \cosh y + \sinh x \sinh y$ ) and follows from  $(r_1 - r_2r_3)^2 \leq (r_2^2 - 1)(r_3^2 - 1)$ . We arrived at (4.5.8). The inequality (4.5.8) is the triangle inequality in terms of tances. It codifies simultaneously the three triangle inequalities involving  $p_1, p_2, p_3$ . The equality occurs exactly when  $p_1, p_2, p_3$  belong to a same geodesic.



**4.5.9. Exercise.** Prove the triangle inequalities for the complex hyperbolic plane  $BV$  and for the Fubini-Study spaces.

In conclusion: there is no need to deal with distances in the hermitian manifolds under consideration. All we need is tance, hermitian algebra, and the synthetic description of geodesics introduced above. The fact (sometimes taken as a definition) that a geodesic is a curve locally minimizing distance is of course valid in our case. We postpone the proof of this fact until Appendix 10A.

**4.5.10. Exercise.** Identify the Poincaré and Beltrami-Klein discs with unit discs centred at the origin on a plane (of complex numbers). Show that the map  $z \mapsto \frac{2z}{1+|z|^2}$ , up to a scale factor, is an isometry.

We have forgotten to mention one more type of geodesic. It corresponds to a subspace  $W \leq V$  whose hermitian form is real, nonnull, and degenerate. In spite of the fact that the length of every segment contained in such  $\mathbb{P}_{\mathbb{K}}W$  vanishes,  $\mathbb{P}_{\mathbb{K}}W$  is a *bona fide* geodesic (see Section 4.7).

**4.5.11. Duality.** The hermitian form establishes a bijection between points and geodesics in the Möbius-Beltrami-Klein projective plane: the point  $p \in \mathbb{P}_{\mathbb{R}}V$  corresponds to the geodesic  $\mathbb{P}_{\mathbb{R}}p^{\perp}$ . If  $p$  is negative/positive, then  $\mathbb{P}_{\mathbb{R}}p^{\perp}$  is spherical/hyperbolic. If  $p$  is isotropic, then  $\mathbb{P}_{\mathbb{R}}p^{\perp}$  is a degenerate geodesic (with  $p^{\perp}$  of signature  $0+$ ) that is tangent to the absolute and passes through  $p$ .

On the one hand, a hyperbolic geodesic is simply a pair of distinct points at the absolute (its vertices). On the other hand, a hyperbolic geodesic in the Beltrami-Klein disc is given by a positive point. This means that the Möbius band  $EV$  equipped with its lorentzian metric describes the geometry of the space of geodesics in the Beltrami-Klein disc.

**4.6. Space of circles.** In this section, we deal with the Riemann-Poincaré sphere and study the geometry of ‘linear’ subspaces of the form  $\mathbb{P}_{\mathbb{C}}W$ , where  $W \leq V$  is a 2-dimensional  $\mathbb{R}$ -linear subspace.

When  $W$  is a  $\mathbb{C}$ -linear subspace,  $\mathbb{P}_{\mathbb{C}}W$  is a point. What about the other cases? We will learn that the remaining linear subspaces  $\mathbb{P}_{\mathbb{C}}W$  are geometrically classified by the signature of the form  $(-, -) := \operatorname{Re}\langle -, - \rangle$  on  $W$ .

4.7. Complex hyperbolic zoo.

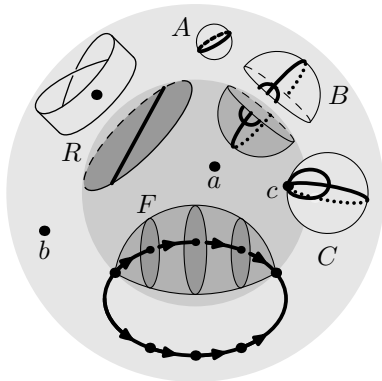

The darker ball is the complex hyperbolic plane  $BV$  and the lighter one is  $EV$ .  $(a)$ ,  $(b)$ , and  $(c)$  are negative, positive, and isotropic points in the extended complex hyperbolic plane. They are respectively dual to the complex geodesics  $(A)$ ,  $(B)$ , and  $(C)$ .

$(A)$  is a round sphere.<sup>12</sup>

$(B)$  is a Riemann-Poincaré sphere divided by the absolute into its hyperbolic discs. Two geodesics and the absolutes are drawn.

$(C)$  is a degenerate complex geodesic. Excluding the isotropic point  $(c)$ , its geometry is affine. Two geodesics are drawn.

$(R)$  is a Möbius-Beltrami-Klein projective plane (commonly called an  $\mathbb{R}$ -plane). The point and the geodesic are dual to each other inside the plane (the extension of the geodesic to the band is not in the picture).

$(F)$  is a bisector. Its slices and real spine are drawn. Every slice is a hyperbolic disc (complex geodesic) dual to a point in  $E$  belonging to the real spine.

**4.8. Finite configurations.** In 1872, Felix Klein came up with a brilliant idea: in geometry, one should study the properties of a space which are invariant under the symmetries of the space. This view became known as the *Erlangen Program*. It was, and still is, very revolutionary. Let us give some examples at the level of plane Euclidean geometry. We are used to characterize some triangles in the Euclidean plane as being equal<sup>13</sup> while, in fact, they are not equal as subsets in the plane. The triangles are *geometrically equal*, that is, there exists a symmetry of the plane (a geometry-preserving bijection) that sends one triangle onto the other. The composition of symmetries and the inverse of a symmetry are symmetries. In other words, the symmetries constitute a group (see Section 7 for the definition).

Roughly speaking, geometry is not made of objects, but of objects and movements. The allowed movements vary from case to case and, generally, we can study the geometry of any structure. *This means that we actually study the symmetry group of the structure.* A simple example: studying the geometry of a set with no imposed structure is the study of the permutation group of the set. A difficult example:

*You boil it in sawdust, you salt it in glue  
 You condense it with locusts and tape  
 Still keeping one principal object in view —  
 To preserve its symmetrical shape.*

— LEWIS CARROLL, *The Hunting of the Snark*

<sup>12</sup>Well, with negative definite metric.

<sup>13</sup>It is certain that absolute equality does not exist in the real world. But it does not exist in the mathematical world either! Do you mean that  $1 = 1$  is an absolute equality? No way! This ‘equality’ just expresses the fact that two sets of one element are equivalent in the sense that there exists a bijection between them. For example,  $1 = 1$  does not imply that one person equals another (which seems to be very good!).

In what follows, one can find an intermediate example.

It is easy to figure out that the symmetries of a  $\mathbb{K}$ -linear space  $V$  equipped with a hermitian form  $\langle -, - \rangle$  are all the  $\mathbb{K}$ -linear isomorphisms  $g : V \rightarrow V$  preserving  $\langle -, - \rangle$ . They constitute the *unitary group*

$$UV := \{g \in GLV \mid \langle gv, gv' \rangle = \langle v, v' \rangle \text{ for all } v, v' \in V\}.$$

The Gram matrix provides the geometrical classification of generic finite configurations in  $V$  (finite configuration = finite tuple of points) :

**4.8.1. Stollen Carlos' lemma.** *Let  $w_1, w_2, \dots, w_k \in V$  and  $w'_1, w'_2, \dots, w'_k \in V$  be configurations such that the subspaces  $W := \mathbb{K}w_1 + \mathbb{K}w_2 + \dots + \mathbb{K}w_k$  and  $W' := \mathbb{K}w'_1 + \mathbb{K}w'_2 + \dots + \mathbb{K}w'_k$  are nondegenerate. Then the configurations are geometrically equal, i.e., there exists  $g \in UV$  such that  $gw_i = w'_i$  for all  $i$ , iff their Gram matrices  $G(w_1, w_2, \dots, w_k)$  and  $G(w'_1, w'_2, \dots, w'_k)$  are equal.*

**Proof.** If such a  $g$  exists, then  $\langle w'_i, w'_j \rangle = \langle gw_i, gw_j \rangle = \langle w_i, w_j \rangle$  for all  $i, j$  since  $g \in UV$ . In other words,  $G(w'_1, w'_2, \dots, w'_k) = G(w_1, w_2, \dots, w_k)$ .

Conversely, suppose that  $G(w_1, w_2, \dots, w_k) = G(w'_1, w'_2, \dots, w'_k)$ . We define the linear map  $h : \mathbb{K}^k \rightarrow W$ ,  $h : (c_1, c_2, \dots, c_k) \mapsto \sum_{i=1}^k c_i w_i$ . Obviously,  $h$  is surjective. In a similar way, we define the surjective linear map  $h' : \mathbb{K}^k \rightarrow W'$ . Let us prove that  $\ker h = \ker h'$ . By symmetry, it suffices to show that  $\ker h \subset \ker h'$ . If  $(c_1, c_2, \dots, c_k) \in \ker h$ , that is, if  $\sum_{i=1}^k c_i w_i = 0$ , then

$$0 = \left\langle \sum_{i=1}^k c_i w_i, w_j \right\rangle = \sum_{i=1}^k c_i \langle w_i, w_j \rangle = \sum_{i=1}^k c_i \langle w'_i, w'_j \rangle = \left\langle \sum_{i=1}^k c_i w'_i, w'_j \right\rangle$$

for all  $j$ . Being  $W'$  nondegenerate, we have  $\sum_{i=1}^k c_i w'_i = 0$ , that is,  $(c_1, c_2, \dots, c_k) \in \ker h'$ .

We obtained a linear isomorphism  $l : W \rightarrow W'$  such that  $lw_i = w'_i$  for all  $i$ . It follows from  $G(w_1, w_2, \dots, w_k) = G(w'_1, w'_2, \dots, w'_k)$  that  $l$  preserves the form, that is,  $\langle lx, ly \rangle = \langle x, y \rangle$  for all  $x, y \in W$ . In particular,  $W$  and  $W'$  are of the same signature. By Exercise 6.6, we have orthogonal decompositions  $V = W \oplus W^\perp$  and  $V = W' \oplus W'^\perp$ . Hence,  $W^\perp$  and  $W'^\perp$  are of the same signature. Therefore, there exists a linear isomorphism  $l' : W^\perp \rightarrow W'^\perp$  that preserves the form. It remains to define  $g : V \rightarrow V$  by the rule  $g : w + u \mapsto lw + l'u$ , where  $w \in W$  and  $u \in W^\perp$  ■

**4.8.2.\* Exercise.** Find necessary and sufficient conditions for the geometric equality of two finite configurations without the assumption that  $W$  and  $W'$  are nondegenerate.

**4.9. There is no sin south of the equator.**<sup>14</sup> The word trigonometry stands in the Greek for ‘measuring triangles.’ The typical approach to studying triangles in non-Euclidean plane geometry is to write down several identities that relate, via trigonometric and hyperbolic trigonometric functions like  $\sin$ ,  $\cos$ ,  $\sinh$ ,  $\cosh$ , etc., the angles and the lengths of the sides of a triangle. Since high school, we are used to ‘solve’ triangles via trigonometry ... let us see how the study of finite configurations in classic geometries developed in the previous section may help in understanding where trigonometric relations come from.

We begin with spherical plane geometry. As in the first of Examples 4.4, let  $V$  be a 2-dimensional complex linear space with a hermitian form  $\langle -, - \rangle$  of signature  $++$ . The Riemann sphere  $\mathbb{P}_{\mathbb{C}}V$  endowed with the metric (4.3.1) is the round sphere of radius  $\frac{1}{2}$ . Let  $p_1, p_2, p_3 \in \mathbb{P}_{\mathbb{C}}V$  be distinct points such that  $\langle p_i, p_j \rangle \neq 0$  for all  $i, j$ . They determine the oriented triangle  $\Delta(p_1, p_2, p_3)$  whose side  $p_i p_{i+1}$  is the shortest segment of geodesic joining  $p_i$  and  $p_{i+1}$  (the indices are modulo 3). In particular,  $l_i := \ell(p_i p_{i+1}) < \frac{\pi}{2}$ . We know from Exercise 4.8. that there exist representatives  $p_1, p_2, p_3 \in V$  with the Gram matrix  $\begin{bmatrix} 1 & r_1 & r_3 \bar{\varepsilon} \\ r_1 & 1 & r_2 \\ r_3 \varepsilon & r_2 & 1 \end{bmatrix}$ , where  $0 < r_i < 1$  and  $\varepsilon \in \mathbb{C}$  with  $|\varepsilon| = 1$ . The geometrical meaning of every number in this matrix is known:  $r_i = \sqrt{\tan(p_i, p_{i+1})}$  and  $\arg \varepsilon = 2 \text{ area } \Delta(p_1, p_2, p_3)$ . So, the  $r_i$ ’s speak of the lengths of the sides of  $\Delta(p_1, p_2, p_3)$  while  $\varepsilon$  provides the oriented area of the triangle. Being  $p_1, p_2, p_3$  linearly dependent, the determinant of the Gram matrix vanishes:

$$(4.9.1) \quad 1 + 2r_1 r_2 r_3 \operatorname{Re} \varepsilon - r_1^2 - r_2^2 - r_3^2 = 0.$$

This equation is the only relation between the geometric invariants  $r_1, r_2, r_3, \varepsilon$  (not counting inequalities). This is the *fundamental trigonometric identity*, and any other one is derivable from it!

For instance, the *first law of cosines* in spherical trigonometry states that

$$\cos(2l_3) = \cos(2l_1) \cos(2l_2) + \cos \alpha \sin(2l_1) \sin(2l_2)$$

under the condition  $0 < \alpha < \pi$  for the interior angle  $\alpha$  at  $p_2$ . In order to deduce this law from (4.9.1), we remind the relation between length and tance in the spherical geometry:  $l_i = \arccos r_i$  (see Subsection 4.5.4). It follows that  $\cos(2l_i) = 2r_i^2 - 1$  and  $\sin(2l_i) = 2r_i \sqrt{1 - r_i^2}$ . So, the first law of cosines is equivalent to

$$(4.9.2) \quad \cos \alpha = \frac{r_1^2 + r_2^2 + r_3^2 - 2r_1^2 r_2^2 - 1}{2r_1 r_2 \sqrt{1 - r_1^2} \cdot \sqrt{1 - r_2^2}}.$$

By Exercise 4.5.3, the tangent vectors

$$t_1 := \langle -, p_2 \rangle \frac{\pi[p_2]p_1}{\langle p_1, p_2 \rangle}, \quad t_2 := \langle -, p_2 \rangle \frac{\pi[p_2]p_3}{\langle p_3, p_2 \rangle}$$

are respectively tangent to  $p_2 p_1$  and  $p_2 p_3$  at  $p_2$ . Therefore,

$$\cos \alpha = \frac{\operatorname{Re} \langle t_1, t_2 \rangle}{\sqrt{\langle t_1, t_1 \rangle} \cdot \sqrt{\langle t_2, t_2 \rangle}} = \frac{r_3 \operatorname{Re} \varepsilon - r_1 r_2}{\sqrt{1 - r_1^2} \cdot \sqrt{1 - r_2^2}}.$$

Using the fundamental trigonometric identity (4.9.1), it is easy to see that the above expression is exactly (4.9.2).

---

<sup>14</sup>A quote from the famous brazilian musician Chico Buarque.

**4.9.3. Exercise.** Derive the *law of sines*

$$\frac{\sin(2l_1)}{\sin \alpha_3} = \frac{\sin(2l_2)}{\sin \alpha_1} = \frac{\sin(2l_3)}{\sin \alpha_2}$$

in spherical plane geometry assuming that the length  $l_i$  of the side  $p_i p_{i+1}$  and the interior angle  $\alpha_i$  at the vertex  $p_i$  of the triangle  $\Delta(p_1, p_2, p_3)$  satisfy the inequalities  $0 < l_i < \frac{\pi}{2}$  and  $0 < \alpha_i < \pi$ ,  $i = 1, 2, 3$ .

**4.9.4. Exercise.** Let  $\Delta(p_1, p_2, p_3)$  be a triangle in the Riemann-Poincaré sphere with distinct non-isotropic vertices of the same signature. Write down the fundamental trigonometric identity for the triangle and derive the *first* and *second laws of cosines* as well as the *law of sines* in hyperbolic geometry:

$$\cosh(2l_3) = \cosh(2l_1) \cosh(2l_2) - \cos \alpha_2 \sinh(2l_1) \sinh(2l_2),$$

$$\cos \alpha_2 + \cos \alpha_2 \cos \alpha_3 = \cosh(2l_3) \sin \alpha_2 \sin \alpha_3,$$

$$\frac{\sinh(2l_1)}{\sin \alpha_3} = \frac{\sinh(2l_2)}{\sin \alpha_1} = \frac{\sinh(2l_3)}{\sin \alpha_2},$$

where  $l_i$  stands for the length of the side  $p_i p_{i+1}$  and  $\alpha_i$ , for the interior angle at  $p_i$  (the indices are modulo 3). Study the trigonometry of triangles with the other signatures of vertices (including isotropic ones).

**4.10A. Geometry on the absolute.**

**4.11. A bit of history.** In 1820, the eighteen years old hungarian mathematician János Bolyai began to write a treatise on non-Euclidean geometry. His father, Farkas Bolyai, had himself struggled in vain with the parallel postulate for many years. Farkas Bolyai did not measure efforts in trying to dissuade his son from following what he thought was a hopeless path:

*‘You must not attempt this approach to parallels. I know this way to its very end. I have traversed this bottomless night, which extinguished all light and joy of my life. I entreat you, leave the science of parallels alone . . . I thought I would sacrifice myself for the sake of truth. I was ready to become a martyr who would remove the flaw from geometry and return it purified to mankind. I accomplished monstrous, enormous labors; my creations are far better than those of others and yet I have not achieved complete satisfaction . . . I turned back when I saw that no man can reach the bottom of the night. I turned back unconsolated, pitying myself and all mankind.*

*I admit that I expect little from the deviation of your lines. It seems to me that I have been in these regions; that I have traveled past all reefs of this infernal Dead Sea and have always come back with broken mast and torn sail. The ruin of my disposition and my fall date back to this time. I thoughtlessly risked my life and happiness — aut Caesar aut nihil.’*

Yet, János had enough courage to pursue his ideas. And where many failed, the young genius succeeded . . . He wrote to his father:

*‘It is now my definite plan to publish a work on parallels as soon as I can complete and arrange the material and an opportunity presents itself . . . I have discovered such wonderful things that I was amazed, and it would be an everlasting piece of bad fortune if they were lost. When you, my dear Father, see them, you will understand; at present I can say nothing except this: that out of nothing I have created a strange new universe. All that I have sent you previously is like a house of cards in comparison with a tower. I am no less convinced that these discoveries will bring me honor than I would be if they were completed.’*

Naturally, János desired to present his discoveries to the foremost of the mathematicians, the *princeps mathematicorum*, Carl Friedrich Gauss. It turns out that Farkas Bolyai was old friends with Gauss, and the opportunity János was so eagerly looking for stood right in front of him: his father would write a letter to Gauss and communicate his son’s great accomplishments. It could not get any better.

Finally, an answer from Gauss to Farkas arrived:

*‘If I begin with the statement that I dare not praise such a work, you will of course be startled for a moment.’*

Why not praise my work? — thought János. Is it possible that everything is wrong? Have I, like many, fell in some of the elusive traps surrounding the parallels? No, it must not be!

*‘but I cannot do otherwise;’* — proceeded Gauss — *‘to praise it would amount to praising myself; for the entire content of the work, the path which your son has taken, the results to which he is led, coincide almost exactly with my own meditations which have occupied my mind for from thirty to thirty-five years.’*

That definitely was not fair! — thought János — Could not Gauss acknowledge honestly, definitely, and frankly my work? Verily, it is not this attitude we call life, work, and merit. János was so profoundly disappointed that he could never fully recover from this episode.

It was a rainy evening, October 17 1841, when János received from his father a brochure entitled, to his surprise, ‘Geometrische Untersuchungen zur Theorie der Parallellinien’ (Geometrical investigations on the theory of parallel lines). János was a polyglot and spoke perfectly nine foreign languages. Reading German was no challenge to him. The author of the brochure? Some russian professor Nikolai Ivanovich Lobachevsky. The more János read the brochure, the more puzzled he got. All his cherish discoveries, the great discoveries no one would ever acknowledge him for, they were all there . . . he flipped the pages

with more and more anguish . . . no doubts, the work in his hands was a masterpiece. János closed the brochure and left it on the table. He took a few steps back and just glanced at the brochure for a while. A russian professor Nikolai Ivanovich Lobachevsky . . . that writes a beautiful text in German about non-Euclidean geometry . . . János eyes became injected with rage and he punched the table furiously. This is the last straw! — he cried. János utmost suspicion, naturally, was that no professor Lobachevsky ever existed, and that the brochure was nothing but a work of Gauss.

**4.11.1. References.** For the correspondence between Farkas Bolyai and János Bolyai see [Mes]. For the story about the brochure see [Kag, p. 391, l. 13–15]. For Gauss' correspondence see [Sch].

[Kag] Kagan, V. F., *Lobachevsky*, edition of the Academy of Sciences of the USSR, Moscow-Leningrad, 1948 (Russian)

[Mes] Meschkowski, H., *Evolution of mathematical thought*, Holden-Day, San Francisco, 1965

[Sch] Schmidt, F., and Stäckel, P., *Briefwechsel zwischen C. F. Gauss and W. Bolyai*, Johnson Reprint Corp. New York, 1972 (German)

## 5. Riemann surfaces

### 5.1. Regular covering and fundamental group.

### 5.2. Discrete groups and Poincaré polygonal theorem.

### 5.3. Teichmüller space.

## 6. Appendix: Largo al factotum della citta

If you leave the Universidad de Sevilla and walk down the Calle Palos de la Frontera street (heading the Plaza de España), you might unexpectedly hear the melody

*Rasori e pettini  
lancette e forbici  
al mio comando  
tutto qui sta.*<sup>15</sup>

coming out of a barber shop. It sounds so familiar that you decide to enter the shop. The barber introduces himself:

- Ciao, mi chiamo Figaro, il barbiere-factotum.<sup>16</sup>
- Hi, I am a student of mathematics here at the University.
- Hum, a mathematician ... The mathematicians use to look for me only for two reasons ... — Figaro seems annoyed.
- ... they do not know how to solve the Barber Paradox<sup>17</sup> ...
- ... or they cannot solve their problems because they do not know the linear tools, like Linear Algebra! To say nothing of Hermitian Tools! — Figaro is now furious.

You may become confused. It is a comprehensible thing that mathematicians could seek the barber to get convinced of his existence. But ...

- Why on earth would an ignorant in Linear Algebra look for you?
- Not knowing Linear Algebra is a barbarity. And I am a barber, what do you expect? Sit down and let me introduce to you the linear and hermitian tools:

*Rasori e pettini  
lancette e forbici  
al mio comando  
tutto qui sta.*

We deal with finite-dimensional linear spaces over  $\mathbb{R}$  or  $\mathbb{C}$ . To cover both cases, denote the scalars by  $\mathbb{K}$ . The symbol  $\bar{k}$  stands for the *conjugate* to the (complex) number  $k \in \mathbb{K}$ .

**6.1. Definition.** Let  $V$  be a  $\mathbb{K}$ -linear space. A *hermitian form* is a map  $\langle -, - \rangle : V \times V \rightarrow \mathbb{K}$ ,  $(x, y) \mapsto \langle x, y \rangle$  linear in  $x$  and such that  $\langle x, y \rangle = \overline{\langle y, x \rangle}$  for all  $x, y \in V$ . In other words, the form is *1.5-linear* since  $\langle kx, y \rangle = k\langle x, y \rangle$  and  $\langle x, ky \rangle = \bar{k}\langle x, y \rangle$  for all  $k \in \mathbb{K}$ . If  $W \leq V$  is a subspace, then we can restrict the form  $\langle -, - \rangle$  to  $W$ , getting a linear space  $W$  equipped with the *induced* hermitian form.

**6.2. Definition.** Let  $V$  be a linear space equipped with a hermitian form and let  $W \leq V$  be a subspace. We define  $W^\perp := \{v \in V \mid \langle v, W \rangle = 0\}$ , the *orthogonal* to  $W$ . We call  $V^\perp$  the *kernel* of the form on  $V$ . If the kernel vanishes, we say that the form is *nondegenerate*. If the induced form on a subspace  $W \leq V$  is nondegenerate,  $W$  is said to be *nondegenerate*. For  $U, W \leq V$ , the *orthogonal* of  $W$  *relatively* to  $U$  is given by  $W^{\perp U} := W^\perp \cap U$ .

**6.3. Exercise.** Show that  $W^\perp \leq V$  and  $W \subset W^{\perp\perp}$  for all  $W \leq V$ . Prove also that  $(W_1 + W_2)^\perp = W_1^\perp \cap W_2^\perp$  for all  $W_1, W_2 \leq V$ . Is the identity  $(W_1 \cap W_2)^\perp = W_1^\perp + W_2^\perp$  true?

<sup>15</sup>Raisors and combs, blades and scissors at my disposal here they are.

<sup>16</sup>Hello, I am Figaro, a factotum barber.

<sup>17</sup>Also known as Russell's Paradox (Bertrand Russell, British philosopher and mathematician) : Who shaves the barber that shaves only men that do not shave themselves?



**6.4. Exercise.** Define the induced form on  $V/V^\perp$  and verify that this definition is correct. Show that  $V/V^\perp$  is nondegenerate. Decomposing  $V = V^\perp \oplus W$ , prove that the spaces  $V/V^\perp$  and  $W$  equipped with the induced forms are naturally isomorphic.

**6.5. Exercise.** For  $W \leq V$ , show that  $\dim W + \dim W^\perp \geq \dim V$ .

**6.6. Exercise.** Show that  $V = W \oplus W^\perp$  for every nondegenerate subspace  $W \leq V$ .

**6.7. Exercise.** Suppose that both  $W$  and  $V$  are nondegenerate, where  $W \leq V$ . Prove that  $W^{\perp\perp} = W$ .

**6.8. Exercise.** Suppose that both  $W$  and  $V$  are nondegenerate, where  $W \leq V$ . Show that  $W^\perp$  is nondegenerate.

**6.9. Exercise.** Show that there exists a *nonisotropic*  $v \in V$ , i.e.,  $\langle v, v \rangle \neq 0$ , if  $\langle -, - \rangle \neq 0$ .

**6.10. Exercise.** Suppose that both  $W$  and  $V$  are nondegenerate, where  $W \leq V$ . Show that there exists a nondegenerate subspace  $W' \leq V$  such that  $W \leq W'$  and  $\dim W' = \dim W + 1$ .

**6.11. Definition.** A *flag* of subspaces is a chain of subspaces  $V_0 \leq V_1 \leq \dots \leq V_n$  such that  $V_n = V$  and  $\dim V_i = i$  for all  $i$ . If  $V$  is equipped with a hermitian form, a flag is *nondegenerate* when all  $V_i$ 's are nondegenerate.

**6.12. Exercise.** Show that every nondegenerate linear space admits a nondegenerate flag of subspaces.

**6.13. Definition.** A linear basis  $\beta : b_1, b_2, \dots, b_n$  is *orthonormal* if  $\langle b_i, b_i \rangle \in \{-1, 0, 1\}$  and  $\langle b_i, b_j \rangle = 0$  for all  $i$  and  $j$  such that  $i \neq j$ . Denote by  $\beta_-, \beta_0, \beta_+$  the amount of elements in the basis  $\varepsilon$  such that  $\langle b_i, b_i \rangle = -1, \langle b_i, b_i \rangle = 0, \langle b_i, b_i \rangle = 1$ , respectively. The triple  $(\beta_-, \beta_0, \beta_+)$  is the *signature* of the basis.

**6.14. Exercise.** Let  $\beta : b_1, b_2, \dots, b_n$  be an orthonormal basis in  $V$ . Show that  $\beta_0$  is the dimension of the kernel of the form on  $V$ ,  $\beta_0 = \dim V^\perp$ .

**6.15. Gram-Schmidt orthogonalization.** Let  $V_0 \leq V_1 \leq \dots \leq V_n$  be a nondegenerate flag of subspaces in  $V$ . Then there exists an orthonormal basis  $b_1, b_2, \dots, b_n$  in  $V$  such that  $b_1, b_2, \dots, b_k$  is a basis in  $V_k$  for all  $k$ .

**Proof.** Induction on  $n$ . For  $n = 1$ , we simply take some  $0 \neq c_1 \in V_1$  and normalize it:  $b_1 := \frac{c_1}{\sqrt{|\langle c_1, c_1 \rangle|}}$ . (Being  $V_1$  nondegenerate,  $\langle c_1, c_1 \rangle \neq 0$ .) Suppose that, for some  $k < n$ , we have already

found an orthonormal basis  $b_1, b_2, \dots, b_k$  in  $V_k$  such that  $b_1, b_2, \dots, b_i$  is a basis in  $V_i$  for all  $i \leq k$ .

We choose  $c_{k+1} \in V_{k+1} \setminus V_k$  and put  $c'_{k+1} = c_{k+1} - \sum_{i=1}^k \frac{\langle c_{k+1}, b_i \rangle}{\langle b_i, b_i \rangle} b_i$ . Taking into account that the  $b_i$ 's are orthogonal, a straightforward calculus shows that  $\langle c'_{k+1}, b_i \rangle = 0$  for all  $i \leq k$ . If  $c'_{k+1}$  could be isotropic, then it would belong to the kernel of the form on  $V_{k+1}$ . Therefore,  $c'_{k+1}$  is nonisotropic and we can normalize  $c'_{k+1}$ , getting the desired  $b_{k+1}$  ■

**6.16. Corollary.** Every linear space with a hermitian form admits an orthonormal basis.

**Proof.** By Exercise 6.4, we can assume that the space  $V$  is nondegenerate. Using Exercise 6.10, we can build a nondegenerate flag of subspaces in  $V$ . Now, the result follows from 6.15 ■

**6.17. Definition.** Let  $v_1, v_2, \dots, v_k \in V$ . The matrix  $G := G(v_1, v_2, \dots, v_k) := [g_{ij}]$ , where  $g_{ij} := \langle v_i, v_j \rangle$ , is called the *Gram* matrix of  $v_1, v_2, \dots, v_k$ .

Obviously,  $\overline{G^t} = G$ , where  $M^t$  denotes the transpose matrix of  $M$  and  $\overline{M}$  denotes the matrix  $M$  with conjugate entries. In other words,  $G$  is *hermitian* (*symmetric*).

The Gram matrix  $G^{\beta\beta} := G(b_1, b_2, \dots, b_n)$  of some basis  $\beta : b_1, b_2, \dots, b_n$  in  $V$  determines the hermitian form on  $V$  since  $\langle v, v' \rangle = [v]_\beta^t G^{\beta\beta} [v']_\beta$  for all  $v, v' \in V$ , where  $[v]_\beta$  denotes the column matrix whose entries are the coefficients  $c_i$  appearing in the linear combination  $v = \sum_{i=1}^n c_i b_i$ . Indeed, if  $v = \sum_{i=1}^n c_i b_i$  and  $v' = \sum_{i=1}^n c'_i b_i$ , then  $\langle v, v' \rangle = \sum_{i,j=1}^n c_i \langle b_i, b_j \rangle \overline{c'_j} = \sum_{i,j=1}^n c_i g_{ij} \overline{c'_j}$ . A basis is orthonormal iff its Gram matrix is diagonal with diagonal entries  $-1, 0, 1$ . We emphasize that every hermitian matrix is the Gram matrix of a basis in a certain linear space with an appropriate hermitian form.

Let  $\alpha : a_1, a_2, \dots, a_n$  be another basis in  $V$  and let  $M_\alpha^\beta = [m_{ij}]$  be the matrix representing a change of basis from  $\alpha$  to  $\beta$ , that is,  $b_j = \sum_{i=1}^n m_{ij} a_i$  for all  $j$ . Then

$$g_{kl} = \langle b_k, b_l \rangle = \left\langle \sum_{i=1}^n m_{ik} a_i, \sum_{j=1}^n m_{jl} a_j \right\rangle = \sum_{i,j=1}^n m_{ik} \langle a_i, a_j \rangle \overline{m_{jl}} = \sum_{i,j=1}^n m_{ik} f_{ij} \overline{m_{jl}},$$

where  $G^{\alpha\alpha} = [f_{ij}]$ . We obtained the relation  $G^{\beta\beta} = (M_\alpha^\beta)^t G^{\alpha\alpha} \overline{M_\alpha^\beta}$ . In particular, it follows that the sign of  $\det G^{\beta\beta}$  does not depend on the choice of the basis because

$$\det G^{\beta\beta} = \det(M_\alpha^\beta)^t \det G^{\alpha\alpha} \det \overline{M_\alpha^\beta} = \det M_\alpha^\beta \det G^{\alpha\alpha} \overline{\det M_\alpha^\beta} = |\det M_\alpha^\beta|^2 \det G^{\alpha\alpha}.$$

**6.18. Lemma.** *Let  $G^{\beta\beta}$  be the Gram matrix of a basis in a linear space  $V$ . Then  $V$  is degenerate iff  $\det G^{\beta\beta} = 0$  ■*

**6.19. Example.** Let  $V \ni e, f$  be such that  $\langle e, e \rangle > 0 > \langle f, f \rangle$ . We put  $W := \mathbb{K}e + \mathbb{K}f$ . Then  $\dim W = 2$  and every orthonormal basis in  $W$  has signature  $(1, 0, 1)$ . Moreover,  $W$  contains (non-null) nonisotropic elements.

Indeed, we can take  $W = V$ . If  $0 \neq n \in V^\perp$ , then  $V = \mathbb{K}b + \mathbb{K}n$  for some  $b \in V$ . Assuming  $\langle b, b \rangle \geq 0$  we obtain  $\langle v, v \rangle \geq 0$  for all  $v \in V$  and assuming  $\langle b, b \rangle \leq 0$  we obtain  $\langle v, v \rangle \leq 0$  for all  $v \in V$ . Both cases are impossible since  $V$  contains one positive element and one negative element. For a similar reason,  $\dim V = 2$ . Taking an orthonormal basis  $\beta$  in  $V$ , it is easy to see that the signature of such basis is distinct from  $(2, 0, 0)$  (since  $V$  contains a positive element) and from  $(0, 0, 2)$  (since  $V$  contains a negative element). By Exercise 6.14,  $\beta_0 = 0$ . Hence, the signature is  $(1, 0, 1)$ . Obviously, the sum of the elements of the orthonormal basis is isotropic.

**6.20. Sylvester's law of inertia.** *The signature does not depend on the choice of an orthonormal basis.*

**Proof.** Induction on  $\dim V$ . By Exercises 6.4 and 6.14, we can assume that  $V$  is nondegenerate. Let  $\beta : b_1, b_2, \dots, b_n$  and  $\beta' : b'_1, b'_2, \dots, b'_n$  be orthonormal bases. So,  $\beta_0 = \beta'_0 = 0$  by Exercise 6.14. If  $\beta_- = 0$ , then  $\langle v, v \rangle \geq 0$  for all  $v \in V$ , implying  $\beta'_- = 0$ . In the same way,  $\beta_+ = 0$  implies  $\beta'_+ = 0$ . Therefore, we can assume that  $\langle b_n, b_n \rangle = 1$  and  $\langle b'_n, b'_n \rangle = -1$ . We put

$$W := \mathbb{K}b_n + \mathbb{K}b'_n, \quad U := (\mathbb{K}b_n)^\perp, \quad U' = (\mathbb{K}b'_n)^\perp.$$

It is easy to see that  $U = \mathbb{K}b_1 + \mathbb{K}b_2 + \dots + \mathbb{K}b_{n-1}$  and  $U' = \mathbb{K}b'_1 + \mathbb{K}b'_2 + \dots + \mathbb{K}b'_{n-1}$ . Therefore, the signatures of the indicated bases in  $U$  and  $U'$  are respectively  $(\beta_-, 0, \beta_+ - 1)$  and  $(\beta'_- - 1, 0, \beta'_+)$ . By Exercise 6.3,  $W^\perp = U \cap U'$ . By Example 6.19 and Exercise 6.14,  $W$  is nondegenerate. So,  $U \cap U'$  is

nondegenerate by Exercise 6.8. Applying Exercise 2.6 to the spaces  $U$  and  $U'$  and to the subspace  $U \cap U'$ , we obtain the orthogonal decompositions  $U = (U \cap U') \oplus (U \cap U')^{\perp U}$  and  $U' = (U \cap U') \oplus (U \cap U')^{\perp U'}$ . Using Corollary 6.16, we choose an orthonormal basis  $\alpha$  in  $U \cap U'$ . Let  $\gamma$  and  $\gamma'$  be some orthonormal bases respectively in  $(U \cap U')^{\perp U}$  and  $(U \cap U')^{\perp U'}$ . Therefore,  $\alpha \sqcup \gamma$  and  $\alpha \sqcup \gamma'$  are orthonormal bases respectively in  $U$  and  $U'$ . Calculating the signatures, we obtain

$$\begin{aligned}(\beta_-, 0, \beta_+ - 1) &= ((\alpha \sqcup \gamma)_-, (\alpha \sqcup \gamma)_0, (\alpha \sqcup \gamma)_+) = (\alpha_-, \alpha_0, \alpha_+) + (\gamma_-, \gamma_0, \gamma_+), \\(\beta'_- - 1, 0, \beta'_+) &= ((\alpha \sqcup \gamma')_-, (\alpha \sqcup \gamma')_0, (\alpha \sqcup \gamma')_+) = (\alpha_-, \alpha_0, \alpha_+) + (\gamma'_-, \gamma'_0, \gamma'_+)\end{aligned}$$

since the signatures do not depend on the choices of orthogonal bases in  $U$  and  $U'$  by the induction hypothesis. It remains to show that  $(U \cap U')^{\perp U} = (\mathbb{K}b_n)^{\perp W}$  and that  $(U \cap U')^{\perp U'} = (\mathbb{K}b'_n)^{\perp W}$  since this implies  $(\gamma_-, \gamma_0, \gamma_+) = (1, 0, 0)$  and  $(\gamma'_-, \gamma'_0, \gamma'_+) = (0, 0, 1)$  by Example 2.19.

Being  $W$  and  $V$  nondegenerate,  $(U \cap U')^{\perp U} = (U \cap U')^{\perp} \cap U = W^{\perp \perp} \cap U = W \cap (\mathbb{K}b_n)^{\perp} = (\mathbb{K}b_n)^{\perp W}$  by Exercise 6.7. For the same reason,  $(U \cap U')^{\perp U'} = (\mathbb{K}b'_n)^{\perp W}$  ■

We can now speak of the *signature* of a space. How do we measure it? By Exercise 6.14,  $\beta_0 = \dim V^{\perp}$ . Using Exercise 6.4, the problem can be reduced to the case of a nondegenerate  $V$ . Let  $\gamma : c_1, c_2, \dots, c_n$  be a basis in  $V$  with a known Gram matrix  $G^{\gamma\gamma}$ . We want to find out the signature of  $V$  in terms of  $G^{\gamma\gamma}$ . Defining  $V_k := \mathbb{K}c_1 + \mathbb{K}c_2 + \dots + \mathbb{K}c_k$  for every  $0 \leq k \leq n$ , we obtain a flag of subspaces. Obviously, the Gram matrix of the basis  $c_1, c_2, \dots, c_k$  in  $V_k$  is the  $(k \times k)$ -submatrix  $G_k^{\gamma\gamma}$  (called a *principal* submatrix) formed by the first  $k$  lines and by the first  $k$  columns of  $G^{\gamma\gamma} = G_n^{\gamma\gamma}$ . We assume that the flag is nondegenerate. By Lemma 6.18, this is equivalent to  $\det G_k^{\gamma\gamma} \neq 0$  for all  $1 \leq k \leq n$ . We apply<sup>18</sup> Orthogonalization 6.15 to the flag and observe that the signs of the determinants  $\det G_k^{\gamma\gamma}$  related to the bases  $b_1, b_2, \dots, b_k, c_{k+1}, c_{k+2}, \dots, c_n$  do not change when we increase  $k$  because the first  $l$  elements in  $b_1, b_2, \dots, b_k, c_{k+1}, c_{k+2}, \dots, c_n$  constitute a basis in  $V_l$  for all  $l$ . When we arrive at an orthonormal basis, the signature can be measured as follows:

**6.21. Sylvester criterion.** *If  $\det G_k^{\gamma\gamma} \neq 0$  for every  $1 \leq k \leq n$ , then the signature of the space equals  $(n_-, 0, n_+)$ , where  $n_-$  is the amount of negative numbers in the sequence*

$$\det G_1^{\gamma\gamma}, \quad \frac{\det G_2^{\gamma\gamma}}{\det G_1^{\gamma\gamma}}, \quad \frac{\det G_3^{\gamma\gamma}}{\det G_2^{\gamma\gamma}}, \quad \dots, \quad \frac{\det G_n^{\gamma\gamma}}{\det G_{n-1}^{\gamma\gamma}}$$

and  $n_+$  is the amount of positive numbers in the same sequence ■

**6.22.\* Exercise.** Find a criterion without the assumption that  $\det G_k^{\gamma\gamma} \neq 0$  for every  $k$ .

Exercises 6.23–26 concern the study of the possible signatures of a subspace when the signature of the space is given. Note that two spaces of the same signature admit an isomorphism between them that preserves the form.

**6.23. Exercise.** Let  $V$  be a space of signature  $(n_-, n_0, n_+)$ . Show that  $V$  contains a subspace  $W$  of signature  $(m_-, m_0, m_+)$  iff the space  $V/V^{\perp}$  (of signature  $(n_-, 0, n_+)$ ) possesses a subspace of signature  $(m_-, m_0 - m, m_+)$  for some  $m$  such that  $0 \leq m \leq n_0$ .

**6.24. Exercise.** Let  $V$  be a space of signature  $(n_-, 0, n_+)$ . Show that  $\min(n_-, n_+)$  is the highest possible dimension of a subspace  $W$  with the null induced form.

**6.25. Exercise.** Let  $V$  be a space of signature  $(n_-, 0, n_+)$ . Show that  $V$  contains a subspace  $W$  of signature  $(m_-, m_0, m_+)$  iff

$$m_- \leq n_-, \quad m_+ \leq n_+, \quad m_0 \leq n_- - m_-, \quad m_0 \leq n_+ - m_+.$$

<sup>18</sup>As it usually happens, the proof is more important than the fact itself.

**6.26. Exercise.** Let  $V$  be a space of signature  $(n_-, n_0, n_+)$ . Show that  $V$  contains a subspace of signature  $(m_-, m_0, m_+)$  iff

$$m_- \leq n_-, \quad m_+ \leq n_+, \quad m_- + m_0 \leq n_- + n_0, \quad m_0 + m_+ \leq n_0 + n_+.$$

**7. Appendix: Basic algebra and topology**

**8. Appendix: Classification of compact surfaces**

**9A. Appendix: Riemannian geometry**

**10A. Appendix: Hyperelliptic surfaces and Goldman's theorem**

## Hints

**1.2.** The question makes no sense.

**2.3.** Draw two distinct lines  $L_1, L_2$  passing through  $p$  that are not parallel to  $R_1, R_2$  and denote the intersections  $\{q_{ij}\} = R_i \cap L_j$ . Joining  $q_{11}, q_{22}$  and  $q_{12}, q_{21}$ , we respectively obtain the lines  $D_1$  and  $D_2$ . They intersect in  $\{d\} = D_1 \cap D_2$ . Denoting  $\{q_i\} = R_i \cap L$ , where  $L$  is the line joining  $p$  and  $d$ , we can construct the lines  $S_1$  and  $S_2$  that join respectively  $q_1, q_{22}$  and  $q_{11}, q_2$ . We claim that the intersection  $\{q\} = S_1 \cap S_2$  lives in the desired line  $R$ . To prove this fact, choose the line joining  $p$  and  $b$  as the infinity, where  $\{b\} = R_1 \cap R_2$ .

**2.5.** Return to this exercise after studying the Beltrami-Klein plane (see 4.5.11).

**2.10.** By induction on dimension, it suffices to deal with subspheres of codimension 1. Such a subsphere can be described as  $S := \{q \in \mathbb{S}^n \mid fq = \varepsilon\}$ , where  $0 \neq f \in V^* := \text{Lin}_{\mathbb{R}}(V, \mathbb{R})$  and  $\varepsilon = 0, 1$ . It remains to observe that  $\varsigma_p^{-1}(v) \in S$  is equivalent to  $(\varepsilon - f(-p))\langle v, v \rangle - 2fv + \varepsilon + f(-p) = 0$ .

**2.11.** Return to this exercise after studying the elements of riemannian geometry. The vector  $\langle -, v \rangle q \in T_q \mathbb{S}^n$ , where  $v \in q^\perp$ , is tangent to the curve  $c(t) := q + tv \in V^*$  at  $c(0) = q$ . Since the definition of  $\varsigma_p$  in Exercise 2.8 works in some open neighbourhood of  $q$  in  $V^*$ , we obtain  $\varsigma_p \langle -, v \rangle q = \frac{(1 + \langle q, p \rangle)v - \langle v, p \rangle(q + p)}{(1 + \langle q, p \rangle)^2}$ . Consequently,  $\langle \varsigma_p \langle -, v_1 \rangle q, \varsigma_p \langle -, v_2 \rangle q \rangle = \frac{\langle v_1, v_2 \rangle}{|1 + \langle q, p \rangle|^2}$  for  $v_1, v_2 \in q^\perp$ .

**3.3.2.** Let  $f \in C^1(U)$  and  $p \in U$ . By the mean value theorem, for every sufficiently small  $\varepsilon > 0$ , there exists  $\varepsilon' \in [0, \varepsilon]$  such that  $\frac{f(p + \varepsilon v) - f(p)}{\varepsilon} = v_{p + \varepsilon' v} f$ . Hence,  $\frac{f(p + \varepsilon w + \varepsilon v) - f(p + \varepsilon w)}{\varepsilon} = v_{p + \varepsilon w + \varepsilon' v} f$  for every sufficiently small  $\varepsilon > 0$  and a suitable  $\varepsilon' \in [0, \varepsilon]$ . We obtain

$$\frac{f(p + \varepsilon v + \varepsilon w) - f(p)}{\varepsilon} = v_{p + \varepsilon w + \varepsilon' v} f + \frac{f(p + \varepsilon w) - f(p)}{\varepsilon}.$$

Since  $v_q f$  is continuous in  $q \in U$ , it follows that  $(v + w)_p f = v_p f + w_p f$ .

**3.3.3.** For some  $p \in U \subset \circ M$  and  $f \in C^\infty(U)$ , we have  $g = f_p$ . The map  $\varphi : v \mapsto v_p f$  (this definition is correct since it is independent of the choice of  $f$  representing  $g$ ; so, we can write  $v_p g$ ) is a  $\mathbb{K}$ -linear functional by Exercise 3.3.2. It follows from the Leibniz rule that  $v_p h = 0$  for all  $v \in V$  and  $h \in \mathfrak{m}_p^2$ , implying the uniqueness.

Let  $b^i \in V$  be some linear basis in  $V$  and let  $\varphi_i \in V^*$  be the corresponding dual basis. Then, by the Newton-Leibniz formula,  $f(v) = f(p) + \sum_i \varphi_i(v - p) f_i(v - p)$ , where  $f_i(w) := \int_0^1 b_{p+tw}^i f dt$  is a smooth function in  $w$  for  $w$  sufficiently close to 0. It remains to apply the same formulae to the functions  $f_i(v - p)$  in  $v$ .

**3.3.4.** Show first that the function  $f : \mathbb{R} \rightarrow \mathbb{R}$  given by the rule  $f(x) := 0$  for  $x \leq 0$  and  $f(x) := \exp(-\frac{1}{x})$  for  $x > 0$  is smooth. Then, assuming that  $V$  is Euclidean, note that  $g^{-1}(\mathbb{R}^+)$  is the open ball of radius  $r$  centred at  $c$ , where  $g(v) := f(r^2 - \langle v - c, v - c \rangle)$  for all  $v \in V$ .

**3.6.6.** There is a homomorphism  $h : \mathcal{F}_p \rightarrow (\mathcal{F}|_S)_p$  given by the rule  $f_p \mapsto (f|_{S \cap U})_p$ , where  $f \in \mathcal{F}(U)$  and  $p \in U \subset \circ M$ . By the definition of induced structure,  $h$  is surjective. It remains to observe that  $\ker h = \{f_p \in \mathcal{F}_p \mid f \in \mathcal{F}(U), f(S \cap U) = 0 \text{ for some } p \in U \subset \circ M\}$ .

**4.3.3.** Show that  $\frac{\sin(2l_3)}{\sin \alpha_2}$  is symmetric in  $r_1, r_2, r_3$ .

**4.4.1.** Use orthogonal coordinates.

**4.5.2.** If  $\langle p_1, p_2 \rangle \neq 0$ , we take  $W := \mathbb{R}p_1 + \mathbb{R}\langle p_1, p_2 \rangle p_2$ . Let  $\langle p_1, p_2 \rangle = 0$  and  $p_1 \in W \leq V$ , where  $\mathbb{P}_{\mathbb{K}}W$  is a geodesic. Then  $\pi[p_1]p \in W$  and  $p_2 = \pi[p_1]p$  for a suitable  $p \in W$ .

**4.5.9.** See Exercise 4.8.?

**4.8.2.** Stealing something from the proof of Stolen Carlos' lemma is useful but this does not suffice.

**6.5.** Using the induction on  $\dim W$ , decompose  $W = W' \oplus \mathbb{K}w$ . Being  $W'^{\perp} \cap (\mathbb{K}w)^{\perp}$  the kernel of the functional  $W'^{\perp} \rightarrow \mathbb{K}$  given by the rule  $x \mapsto \langle x, w \rangle$ , we have  $\dim W^{\perp} = \dim (W'^{\perp} \cap (\mathbb{K}w)^{\perp}) \geq \dim W'^{\perp} - 1$  by Exercise 6.3. The rest follows from  $\dim W = \dim W' - 1$  by induction.

**6.6.**  $W \cap W^{\perp}$  is the kernel of the induced form on  $W$ .

**6.7.** Use  $W \subset W^{\perp\perp}$  and Exercise 6.6.

**6.9.** Assuming that  $\langle v, v \rangle = 0$  for all  $v \in V$ , we obtain  $\langle v_1 + v_2, v_1 + v_2 \rangle = 0$  and, hence,  $\operatorname{Re}\langle v_1, v_2 \rangle = 0$  for all  $v_1, v_2 \in V$ . It remains to apply the last identity to  $iv_1, v_2$ .

**6.10.** Using Exercises 6.8 and 6.9, we can find a nonisotropic  $w \in W^{\perp}$  and put  $W' := W + \mathbb{K}w$ .

**6.23.** Consider  $m = \dim(W \cap V^{\perp})$  and apply Exercise 6.4.

**6.24.** Decompose  $V$  into the orthogonal sum  $V = V_{-} \oplus V_{+}$  of subspaces of signatures  $(n_{-}, 0, 0)$  and  $(0, 0, n_{+})$ . If, say,  $\dim W > n_{-} \leq n_{+}$ , then  $W \cap V_{+} \neq 0$ . In order to construct a subspace of dimension  $\min(n_{-}, n_{+})$  with the null induced form, use the isotropic elements mentioned in Example 6.19.

**6.25.** Decompose  $W$  into the orthogonal sum  $W = W_{-} \oplus W_0 \oplus W_{+}$  of subspaces of signatures  $(m_{-}, 0, 0)$ ,  $(0, m_0, 0)$ , and  $(0, 0, m_{+})$ . Decomposing  $V = (W_{-} + W_{+}) \oplus (W_{-} + W_{+})^{\perp}$ , notice that  $m_{-} \leq n_{-}$ ,  $m_{+} \leq n_{+}$ , and  $W_0 \leq (W_{-} + W_{+})^{\perp}$ , where  $(W_{-} + W_{+})^{\perp}$  has signature  $(n_{-} - m_{-}, 0, n_{+} - m_{+})$ . Using Exercise 6.24, conclude that  $m_0 \leq n_{-} - m_{-}$  and  $m_0 \leq n_{+} - m_{+}$ . For  $m_{-}$ ,  $m_0$ , and  $m_{+}$  that satisfy the above inequalities, construct a subspace of signature  $(m_{-}, m_0, m_{+})$ .