

Tricritical point of J_1 - J_2 Ising model on hyperbolic lattice

R. Krčmar¹, T. Iharagi², A. Gendiar^{1,3}, and T. Nishino²

¹*Institute of Electrical Engineering, Centre of Excellence CENG,*

Slovak Academy of Sciences, Dúbravská cesta 9, SK-841 04, Bratislava, Slovakia

²*Department of Physics, Graduate School of Science, Kobe University, Kobe 657-8501, Japan*

³*Institute for Theoretical Physics C, RWTH Aachen University, D-52056 Aachen, Germany*

(Dated: October 8, 2018)

A ferromagnetic-paramagnetic phase transition of the two-dimensional frustrated Ising model on a hyperbolic lattice is investigated by use of the corner transfer matrix renormalization group method. The model contains ferromagnetic nearest-neighbor interaction J_1 and the competing antiferromagnetic interaction J_2 . A mean-field like second-order phase transition is observed when the ratio $\kappa = J_2/J_1$ is less than 0.203. In the region $0.203 < \kappa < 1/4$, the spontaneous magnetization is discontinuous at the transition temperature. Such tricritical behavior suggests that the phase transitions on hyperbolic lattices need not always be mean-field like.

PACS numbers: 05.50.+q, 05.70.Jk, 64.60.F-, 75.10.Hk

I. INTRODUCTION

The Ising model on the Cayley tree is known by its singular property, where the magnetic susceptibility of the spin at the root of the tree diverges at a temperature T_c despite the fact there is no singularity in the partition function of the whole system [1]. This is a kind of phase transition which can be explained by the Ising model on the Bethe lattice. It has been known that the Ising model on hyperbolic lattices, which are negatively curved in the two-dimensional (2D) space [2], exhibits similar aspects in common [3, 4, 5]. The universality class of the ferromagnetic-paramagnetic phase transition of this model has been so far considered to be mean-field like. Recent numerical studies have supported this conjecture [6, 7, 8, 9].

In this paper we study effects of the antiferromagnetic next-nearest-neighbor (NNN) interaction J_2 , which competes with the ferromagnetic nearest-neighbor (NN) one J_1 , on the ferromagnetic-paramagnetic phase transition of the 2D Ising model on a hyperbolic lattice. We use the corner transfer matrix renormalization group (CTMRG) method [13, 14, 15], which is a variant of the density matrix renormalization group (DMRG) method [16, 17, 18, 19], for the calculations of thermodynamic functions. As we show in the following, the transition temperature T_0 monotonously decreases with the frustration parameter $\kappa = J_2/J_1$ in the region $0 \leq \kappa < 1/4$, where the ground state spin configuration is completely ferromagnetic. We find that there is a tricritical point when the parameter κ is equal to $\kappa_c = 0.203$. The ferromagnetic-paramagnetic phase transition is of the second order for $0 \leq \kappa \leq \kappa_c$, whereas it turns into the first order one for $\kappa_c < \kappa < 1/4$.

In the next section, we explain the so-called (5, 4) lattice in the 2D hyperbolic space and introduce the Ising Hamiltonian on it. As a theoretical ideal, we consider phase transition on the Bethe lattice with the coordination number four, which is equivalent to the $(\infty, 4)$ hyperbolic lattice. In Sec. III we present numerical results.

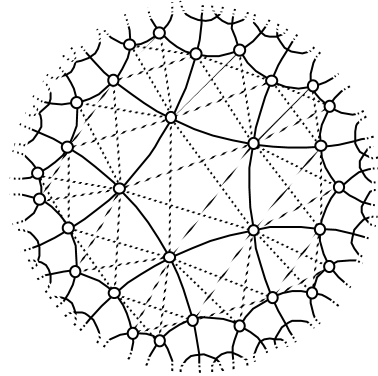

FIG. 1: The (5, 4) hyperbolic lattice drawn in the Poincaré disc. The open circles represent the Ising spins sites. The next-nearest-neighbor interactions are here represented by the dashed lines inside the pentagons.

Temperature dependence of free energy, spontaneous and induced magnetizations are shown. We analyze these thermodynamic functions around the transition temperature T_0 for several values of κ , and determine the critical exponents α , β , and δ . We summarize the observed phase transition in the last section.

II. FRUSTRATED ISING MODEL ON HYPERBOLIC LATTICE

We consider a hyperbolic 2D lattice shown in Fig. 1, where four pentagons share their apexes. Such lattice is conventionally called as the (5, 4) lattice, where the number five represents number of the sides of each pentagon and the number four is the coordination number. Consider the Ising model on this lattice, where on each lattice site labeled by i there is an Ising spin variable $\sigma_i = \pm 1$. We assume ferromagnetic interactions between NN spin pairs shown by the full lines in Fig. 1 and the antiferromagnetic interactions between NNN pairs shown

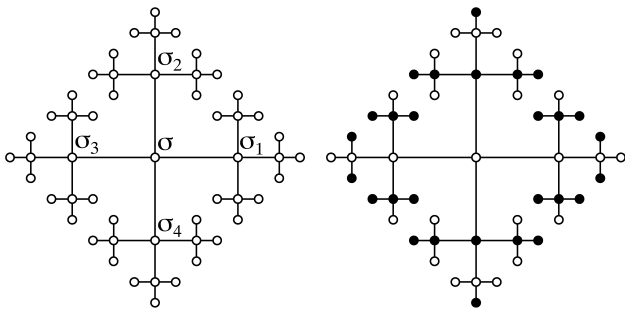

FIG. 2: Ground state spin configurations for $\kappa < 1/4$ (left) and $\kappa > 1/4$ (right) on the $(\infty, 4)$ lattice, which coincides with the Bethe lattice with the coordination number four. Note that only a finite number of spins is here depicted from the $(\infty, 4)$ lattice. Open circles represent spin variable $\sigma = +1$ whereas the full circles correspond to $\sigma = -1$.

by the dashed lines. The Hamiltonian of the system is represented as

$$\mathcal{H} = -J_1 \sum_{\langle ij \rangle = \text{NN}} \sigma_i \sigma_j + J_2 \sum_{\langle ik \rangle = \text{NNN}} \sigma_i \sigma_k, \quad (1)$$

where $J_1 > 0$ is the ferromagnetic coupling constant between the NN pairs $\langle ij \rangle$ and $J_2 > 0$ is the antiferromagnetic one between the NNN pairs $\langle ik \rangle$. Let us define a parameter $\kappa = J_2/J_1$ that represents strength of the frustration.

For purpose of obtaining brief insight of the phase structure of the $(5, 4)$ Ising model, we observe the model from a wider framework. Let us introduce the Ising model on the $(n, 4)$ lattice where four n -gons (polygons of the n^{th} order) meet at each lattice point. When the number of sides n (≥ 5) is multiple of four including the case $n = \infty$, the ground-state spin configuration at zero temperature is easily obtained. Figure 2 shows the ground-state configurations for the case $n = \infty$, where the lattice is nothing but the Bethe lattice with the coordination number four. For the complete ferromagnetic configuration shown on the left, the energy expectation value per site is

$$\varepsilon_{\text{Ferro}} = -2J_1 + 4J_2, \quad (2)$$

and for the ‘up-up-down-down’ structure shown in the right, the value is

$$\varepsilon_{\text{uudd}} = -4J_2. \quad (3)$$

Therefore, the energy cross over $\varepsilon_{\text{Ferro}} = \varepsilon_{\text{uudd}}$ is located at $J_1 = 4J_2$, equivalently at $\kappa = 1/4$. This ground state alternation is common for all the cases where n (≥ 5) is multiple of four. If not, the ground state spin configuration for large κ is not unique and is probably disordered. In the case of the $(5, 4)$ -lattice, one of the ground states in the large κ region can be constructed by joining the pentagons with either ‘up-up-up-down-down’ or ‘up-down-down-down-down’ spin configurations. After a short

algebra, one obtains the energy per site

$$\varepsilon_{\text{uuudd}} = \varepsilon_{\text{uuddd}} = -\frac{2}{5}J_1 - \frac{12}{5}J_2 \quad (4)$$

for the assumed configurations. Hence the energy cross over $\varepsilon_{\text{Ferro}} = \varepsilon_{\text{uuudd}}$ also occurs at $J_1 = 4J_2$.

At finite temperature, the ferromagnetic-paramagnetic phase transition is observed in the small κ region [20]. Consider a single-site mean-field approximation on arbitrary $(n, 4)$ lattice. A mean field variable h is expressed as

$$h = (-4J_1 + 8J_2) \langle \sigma \rangle = -(4 - 8\kappa)J_1 \langle \sigma \rangle, \quad (5)$$

where $\langle \sigma \rangle$ is the expectation value of the Ising spin. A self-consistent condition for $\langle \sigma \rangle$ leads to the ferromagnetic-paramagnetic phase transition with the critical temperature $T_c^{\text{M.F.}}(\kappa) = (4 - 8\kappa)J_1/k_B$, where k_B is the Boltzmann constant. Within this approximation, the transition is always of the second order in the region $0 \leq \kappa < 1/4$, since the effect of J_2 appears as the rescaling of the mean-field h as in Eq. (5). It should be noted that $T_c^{\text{M.F.}}(\kappa = 1/4) = 2J_1/k_B$ is larger than zero. The mean-field approximation predicts another ordered state in the region $\kappa > 1/4$, where the ‘up-up-down-down’ spin configuration is favored if the lattice geometry allows the ordering.

An improvement to the mean-field approximation is achieved by increasing the number of sites that are not averaged. The simplest case is the Bethe approximation, which treats additional spins $\sigma_1, \sigma_2, \sigma_3$, and σ_4 that surround the central site σ , as shown in Fig. 2(left). On arbitrary $(n, 4)$ lattice, the mean field for the surrounding four spins $\sigma_1, \sigma_2, \sigma_3$, and σ_4 is given by

$$h_a = (-3J_1 + 6J_2) \langle \sigma \rangle. \quad (6)$$

As an effect of the next-nearest-neighbor interaction, the central spin σ also feels the mean field, however, of different strength,

$$h_b = 8J_2 \langle \sigma \rangle, \quad (7)$$

in addition to the direct ferromagnetic interaction with the surrounding spins $-J_1 \sigma (\sigma_1 + \sigma_2 + \sigma_3 + \sigma_4)$. Considering these interaction terms, one obtains the self-consistent relation

$$\langle \sigma \rangle = \frac{1}{Z} \sum \sigma \exp[-\beta h_a (\sigma_1 + \sigma_2 + \sigma_3 + \sigma_4) - \beta h_b \sigma + \beta J_1 (\sigma_1 + \sigma_2 + \sigma_3 + \sigma_4) \sigma - \beta J_2 (\sigma_1 \sigma_2 + \sigma_2 \sigma_3 + \sigma_3 \sigma_4 + \sigma_4 \sigma_1)], \quad (8)$$

where $\beta = 1/k_B T$ and where Z is the partition function

$$Z = \sum \exp[-\beta h_a (\sigma_1 + \sigma_2 + \sigma_3 + \sigma_4) - \beta h_b \sigma + \beta J_1 (\sigma_1 + \sigma_2 + \sigma_3 + \sigma_4) \sigma - \beta J_2 (\sigma_1 \sigma_2 + \sigma_2 \sigma_3 + \sigma_3 \sigma_4 + \sigma_4 \sigma_1)]. \quad (9)$$

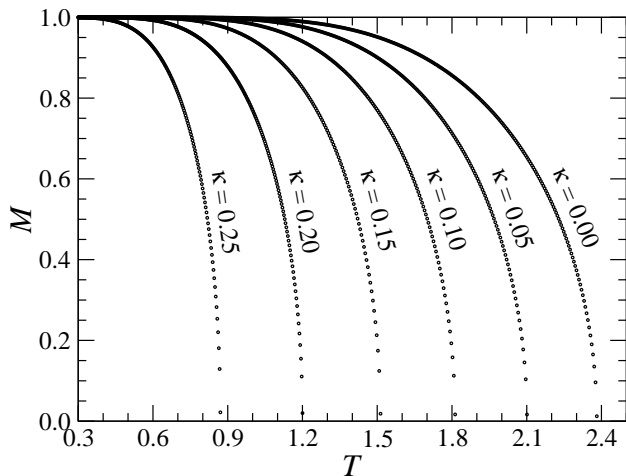

FIG. 3: Spontaneous magnetization $\langle \sigma \rangle$ obtained by the Bethe approximation.

The configuration sums in Eqs. (8) and (9) are taken over the five spins σ , σ_1 , σ_2 , σ_3 , and σ_4 . The factorization

$$W(\sigma_i, \sigma) = \exp \left[-\beta h_a \sigma_i + \beta J_1 \sigma_i \sigma - \beta \frac{h_b}{4} \sigma \right] \quad (10)$$

for $i = 1, 2, 3$, and 4 further simplifies the expression so that the partition function has the form

$$Z = \sum W(\sigma_1, \sigma) W(\sigma_2, \sigma) W(\sigma_3, \sigma) W(\sigma_4, \sigma) \exp[-\beta J_2 (\sigma_1 \sigma_2 + \sigma_2 \sigma_3 + \sigma_3 \sigma_4 + \sigma_4 \sigma_1)]. \quad (11)$$

Since it is not a trivial task to find out an analytic solution of the self-consistent Eqs. (6)-(9), we solved them numerically. We use the parametrization $J_1 = 1$ and $k_B = 1$ throughout this article in the numerical calculations. Figure 3 shows the calculated spontaneous magnetization $M = \langle \sigma \rangle$. The second-order phase transition is detected in the whole region $0 \leq \kappa < 1/4$. As observed in the single-site mean-field approximation, the transition is of the second order, and the transition temperature remains finite even at $\kappa = 1/4$. Further improvement of the Bethe approximation can be achieved by means of gradual increase of unaveraged spin sites. A series of such approximations is known as the coherent anomaly method (CAM) [21]. Here, we do not proceed with the CAM analysis; we perform extensive numerical calculations by the CTMRG method instead.

It has been known that the spin expectation value $\langle \sigma \rangle$ can be calculated exactly at the root of the Cayley tree, which can be treated as the Bethe lattices [1]. For the frustrated Ising model on the $(\infty, 4)$ lattice shown in Fig. 2, the expectation value is expressed as

$$\langle \sigma \rangle = \frac{1}{Z'} \sum \sigma W'(\sigma_1, \sigma) W'(\sigma_2, \sigma) W'(\sigma_3, \sigma) W'(\sigma_4, \sigma) \exp[-\beta J_2 (\sigma_1 \sigma_2 + \sigma_2 \sigma_3 + \sigma_3 \sigma_4 + \sigma_4 \sigma_1)] \quad (12)$$

with the definition of the effective partition function

$$Z' = \sum W'(\sigma_1, \sigma) W'(\sigma_2, \sigma) W'(\sigma_3, \sigma) W'(\sigma_4, \sigma)$$

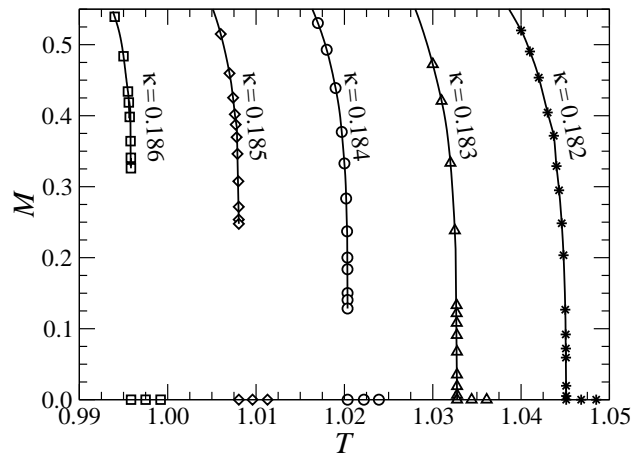

FIG. 4: Spontaneous magnetization of the J_1 - J_2 Ising model on the $(\infty, 4)$ lattice.

$$\exp[-\beta J_2 (\sigma_1 \sigma_2 + \sigma_2 \sigma_3 + \sigma_3 \sigma_4 + \sigma_4 \sigma_1)], \quad (13)$$

where the new factor $W'(\sigma_i, \sigma)$ represents a Boltzmann weight for a branch which connects the root spin σ with the nearest spin site σ_i . (c.f. Fig. 2.) This new factor $W'(\sigma_i, \sigma)$ can be calculated from $W(\sigma_i, \sigma)$ in Eq. (10) repeating the application of the recursive transformation

$$W_{\text{new}}(\sigma_i, \sigma) = \sum_{s_1, s_2, s_3} W(s_1, \sigma) W(s_2, \sigma) W(s_3, \sigma) \exp[\beta J_1 \sigma_i \sigma - \beta J_2 (\sigma s_1 + s_1 s_2 + s_2 s_3 + s_3 \sigma)] \quad (14)$$

for many times until it converges [1]. Thus $W'(\sigma_i, \sigma)$ contains the effect of distant sites on the Bethe lattice. Figure 4 shows the spontaneous magnetization $M = \langle \sigma \rangle$ calculated by Eq. (12) using $W'(\sigma_i, \sigma)$ numerically obtained from Eq. (14). The transition is of the second order in the region $0 \leq \kappa \leq 0.183$ and is of the first order in $0.184 \leq \kappa < 1/4$. One can carry out perturbative calculations to ensure that the transition temperature on the Bethe lattice is zero at $\kappa = 1/4$. The difference between Fig. (3) and Fig. (4) comes from the effect of distant interacting spin sites, which might be essential in the tricritical behavior on the $(5, 4)$ lattice as studied in the next section.

III. NUMERICAL RESULTS BY CTMRG

In this section we analyze the thermodynamic property of the Ising model on the $(5, 4)$ lattice by use of the CTMRG method [13, 14, 15]. The method is a variant of the DMRG method [16, 17, 18] applied to 2D classical models [22]. It has been known that the partition function Z of a square-shaped finite-size system can be calculated as a trace of the fourth power of the so-called corner transfer matrix (CTM), which represents a Boltzmann

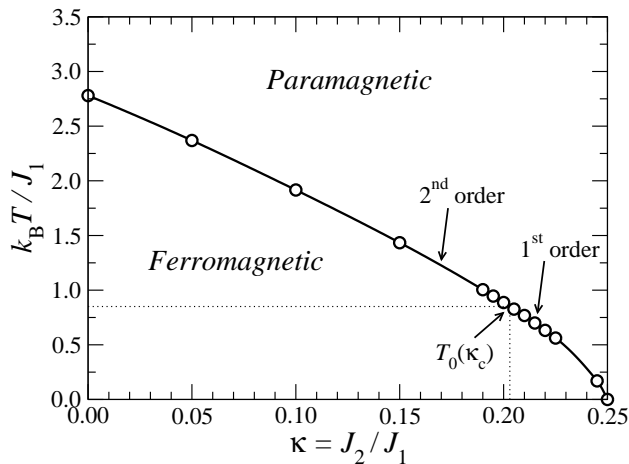

FIG. 5: Phase diagram of the J_1 - J_2 Ising model on the $(5, 4)$ hyperbolic lattice.

weight of a quadrant of the whole system [1]. Although the matrix dimension of the CTM, which is denoted by C , increases exponentially with the linear size of the system, it is possible to transform it into a renormalized one \tilde{C} with a smaller matrix dimension m [23] by means of the RG transformation obtained from the diagonalization of $\rho = C^4$ or C [1, 13, 15]. This transformation is not exact but is highly accurate in such sense that $\tilde{Z} = \text{Tr} \tilde{C}^4$ is a good approximation of $Z = \text{Tr} C^4$. One can precisely calculate thermodynamic (or one-point) functions, such as the free energy $F = -k_B T \log \tilde{Z}$ and the spontaneous magnetization M , for a sufficiently large finite-size system by use of the CTMRG method. Since the $(n, 4)$ lattice can be divided into four equivalent parts (the quadrants), which share the central site σ on their edges, it is also possible to apply the CTMRG method to statistical models on these lattices [8, 9, 12].

In order to study critical phenomena correctly on hyperbolic lattices, we put the following remarks. We always consider a lattices system whose linear size L is several times larger than the corresponding correlation length ξ , so that the central site σ is sufficiently away from the system boundary. The lattice sites in the area within the distance of the order of ξ from the system boundary are affected by the imposed ferromagnetic boundary condition, where all the Ising spins at the system boundary point to the same direction. It should be also noted that portion of such sites that are ‘near the boundary’ in the hyperbolic geometry remains finite even in the thermodynamic limit $L \rightarrow \infty$ [10, 11], where the situation is similar to the case of the Cayley tree [1]. Disregarding all these sites ‘near the boundary’, we focus on the thermodynamic properties of the Ising spins deep inside the system [3, 12].

Figure 5 shows the phase diagram of the system in the parameter region $0 \leq \kappa < 1/4$. The ferromagnetic-paramagnetic phase boundary is determined from the temperature dependence of the free energy $F(\kappa; T)$ and

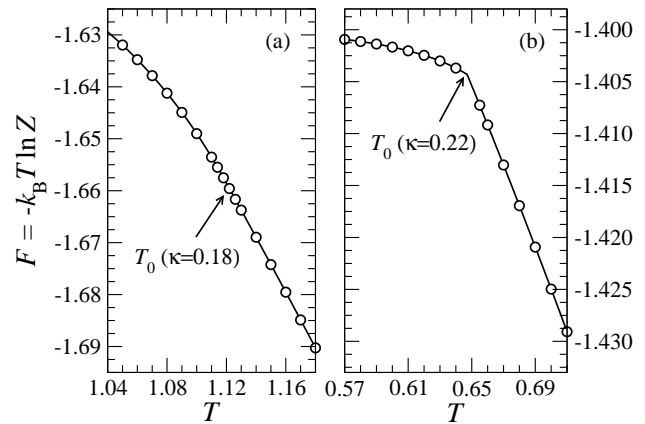

FIG. 6: Dependence of the free energy $F(\kappa; T)$ on temperature when (a) $\kappa = 0.18$ and (b) $\kappa = 0.22$.

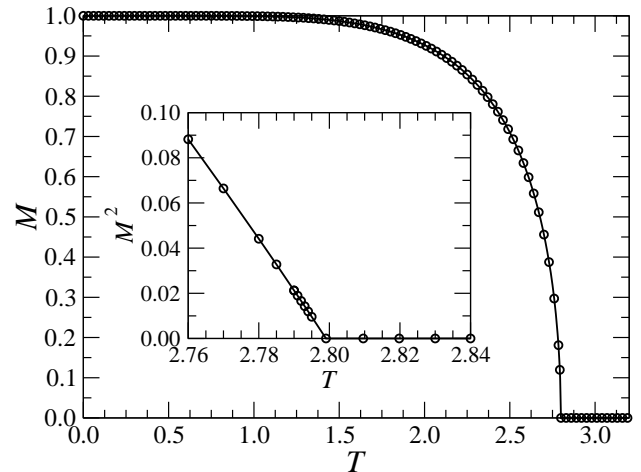

FIG. 7: Spontaneous magnetization M for $\kappa = 0$.

the spontaneous magnetization $M(\kappa; T)$ which we show in the following. As an effect of the competing interactions, the transition temperature $T_0(\kappa)$ monotonously decreases with κ towards $T_0(1/4) = 0$. In the region $0 \leq \kappa \leq 0.203$ the transition is of the second order. In contrast, when $0.203 < \kappa < 1/4$, we observe a first-order transition; the tricritical point is located at $\kappa_c = 0.203$. Figure 6 shows the free energy $F(\kappa; T)$ at $\kappa = 0.18$ and $\kappa = 0.22$. In the region $0.203 < \kappa < 1/4$, the free energy $F(\kappa; T)$ is not a differentiable function at the transition temperature, as shown in Fig. 6(b).

Figure 7 shows the spontaneous magnetization M and its square, M^2 , when there is no frustration $\kappa = 0$. The squared magnetization M^2 is proportional to $T_0 - T$, the behavior which agrees with the critical exponent $\beta = 1/2$. In the second-order transition region $0 \leq \kappa < 0.203$, the universality class remains mean-field like and the magnetization curve satisfies the scaling form

$$M(\kappa; T) = B(\kappa) [T_0(\kappa) - T]^{1/2} \quad (15)$$

around the transition temperature $T_0(\kappa)$. The prefactor

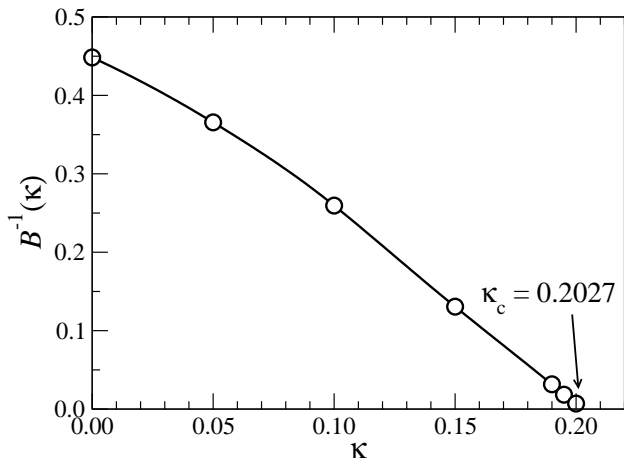

FIG. 8: Inverse of the prefactor $B(\kappa)$, which characterizes the mean-field like transition observed in the spontaneous magnetization.

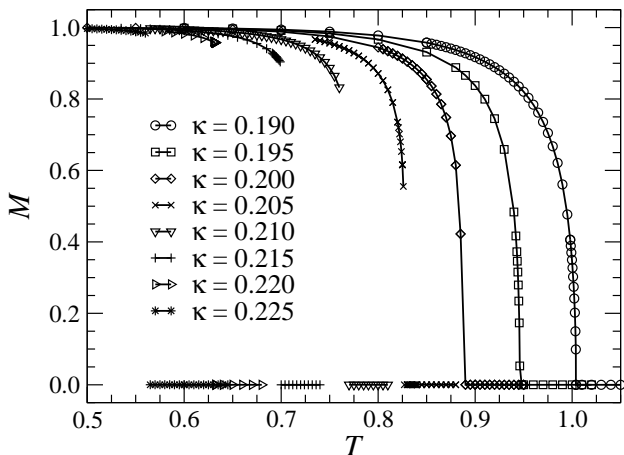

FIG. 9: Temperature dependence of the spontaneous magnetization $M(\kappa; T)$ for several values κ around κ_c .

$B(\kappa)$ is an increasing function of κ and diverges at certain point $\kappa = \kappa_c$. Figure 8 shows the inverse of the prefactor $B(\kappa)$ which linearly decreases to zero in the vicinity of κ_c . We obtain $\kappa_c = 0.2027$ from the linear fitting.

One can also estimate κ_c out of the discontinuity in the spontaneous magnetization $M(\kappa; T)$ in the region $0.203 < \kappa < 1/4$. Figure 9 shows $M(\kappa; T)$ around $\kappa = \kappa_c$. We calculate the discontinuity function (or the jump in the magnetization) $D(\kappa) = M(\kappa; T_0^-)$, where T_0^- corresponds to temperature just below the transition temperature $T_0(\kappa)$. As shown in Fig. 10, the discontinuity function satisfies relation

$$D(\kappa) \propto (\kappa - \kappa_c)^{1/4} \quad (16)$$

around $\kappa = \kappa_c$. Performing a linear fitting shown by the dashed lines, we obtain $\kappa_c = 0.2033$. Comparing this value with $\kappa_c = 0.2027$ obtained from the data in second order region, we conclude that the tricritical point is located at $\kappa_c = 0.203 \pm 0.001$.

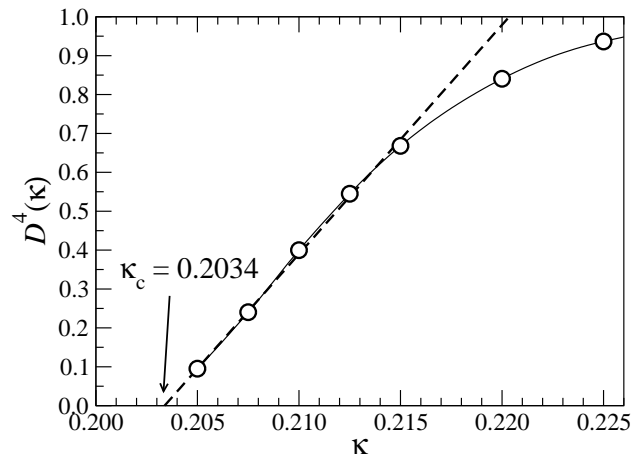

FIG. 10: The discontinuity function of the spontaneous magnetization at the transition temperature T_0 in the first-order transition region $\kappa_c < \kappa < 1/4$.

The observed tricritical behavior around $\kappa = \kappa_c$ is in accordance with the Landau free energy

$$F(M, t) = a M^6 + b(\kappa_c - \kappa)M^4 + ct M^2, \quad (17)$$

where a , b , and c are positive constants or slowly varying functions of temperature. In the second order transition region $\kappa < \kappa_c$, the second and the third terms in $F(M, t)$ are dominant in the vicinity of the phase transition, and the parameter t coincides with $[T - T_0(\kappa)]/T_0(\kappa)$. Neglecting the first term in $F(M, t)$ below $T < T_0(\kappa)$, we can obtain the spontaneous magnetization M that minimizes $F(M, t)$ from the equation $4b(\kappa_c - \kappa)M^2 + 2ct = 0$. The behavior $M^2 \propto |t|$ coincides with the numerical result shown in Fig. 7. In the first order transition region $\kappa > \kappa_c$, all three terms in $F(M, t)$ are important for the minimum of the free energy. After short calculations, one can confirm that the jump of the spontaneous magnetization at the transition temperature coincides with Eq. (16), which we have verified from the numerical data shown in Fig. 10.

At the tricritical point $\kappa = \kappa_c$, the second term in $F(M, t)$ in Eq. (17) vanishes. Thus, the spontaneous magnetization is determined from $6aM^4 + 2ct = 0$, and M^4 is proportional to $T - T_0$. The dependence of M^4 with respect to temperature T obtained from the numerical calculation is shown in Fig. 11. The data are in accordance with $M \propto (T - T_0)^{1/4}$, which corresponds to the exponent $\beta = 1/4$ at tricriticality. In the same manner it is expected that the specific heat diverges as $(T_0 - T)^{-1/2}$, which corresponds to the critical exponent $\alpha = 1/2$. Figure 12 shows the numerically calculated specific heat at $\kappa_c = 0.203$, which agrees with the expected temperature dependence. For comparison, in the inset of Fig. 12, we show the data at $\kappa = 0.18$, which agrees with $\alpha = 0$.

Effect of an external magnetic field H may be included in the Landau free energy by adding the interaction term

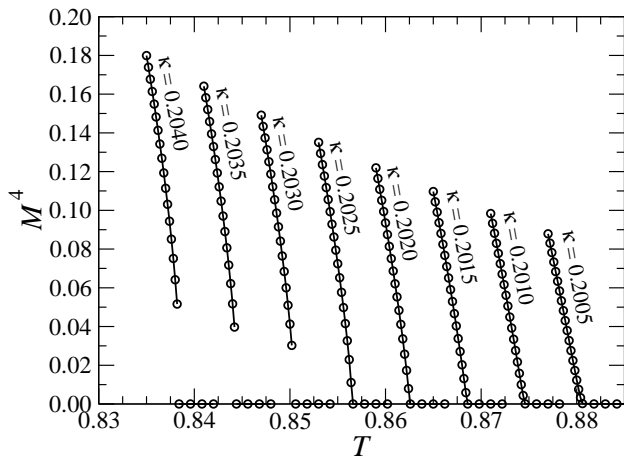

FIG. 11: The fourth power of the spontaneous magnetization around $\kappa = \kappa_c$.

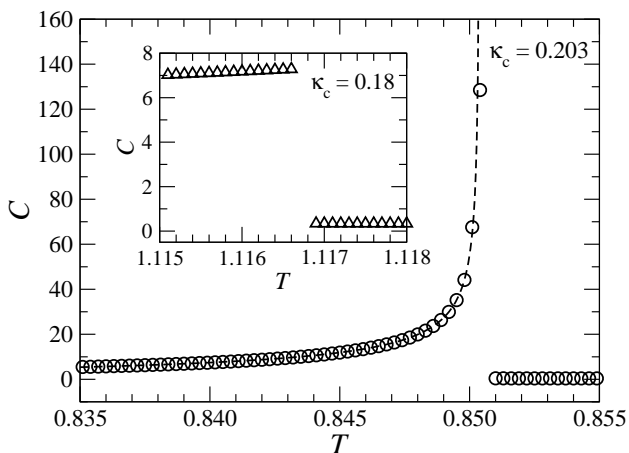

FIG. 12: Specific heat around the tricritical point.

dHM to $F(M, t)$ in Eq. (17), where d is a positive constant. From the assumed form of the free energy it is expected that M^3 and M^5 are, respectively, proportional to $T_0 - T$ when $\kappa < \kappa_c$ and when $\kappa = \kappa_c$. For the confirmation, we observe the induced magnetization at criticality when $\kappa \leq \kappa_c$. Figure 13 shows the induced M with respect to H . In the region of the second order phase transition, we obtained the magnetic exponent $\delta = 3$ as expected. However, the value of the exponent δ is around 7 at the tricritical point, not 5 as expected from the Landau free energy $F(M, t) + dHM$. Such pathological behavior in the induced magnetization is a remaining piece of the puzzle of the current study on the $(5, 4)$ -hyperbolic lattice. Speak about the $J_1 - J_2$ Ising model on the $(\infty, 4)$ -Bethe lattice, we obtain $\delta \sim 6$ at the tricritical point from numerical calculations. Future studies on $(n, 4)$ -lattices for $n \geq 6$ would provide a hint to these unexpected values of δ .

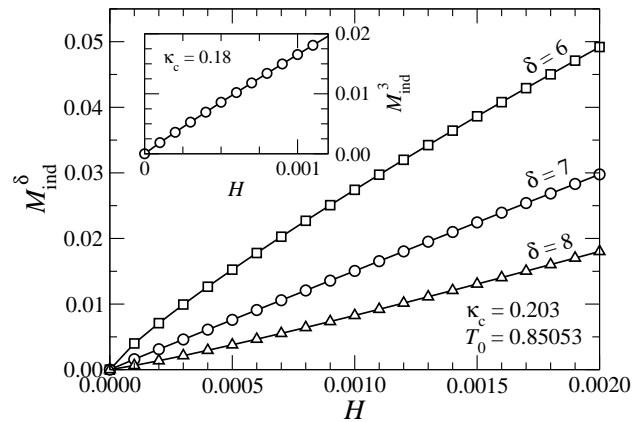

FIG. 13: Induced magnetization (i) at the tricritical point $\kappa = \kappa_c$ and (ii) inset: that at the transition temperature when $\kappa < \kappa_c$.

IV. CONCLUSIONS

We have studied a ferromagnetic-paramagnetic phase transition of the J_1 - J_2 Ising model on the $(5, 4)$ hyperbolic lattice. A tricritical point has been found when the ratio $\kappa = J_2/J_1$, which represents the strength of frustration, is equal to 0.203. It should be noted that the presence of the first-order transition cannot be obtained by the single-site mean-field approximation applied to this system. This is in contrast to the known fact that the phase transition of the nearest-neighbor Ising, Potts, and clock models exhibits mean-field nature [3, 6, 7, 8, 9, 12].

The observed second order phase transition in the parameter region $\kappa < \kappa_c = 0.203$ belongs to the mean-field universality class, which is characterized by the exponents $\alpha = 0$, $\beta = 1/2$, and $\delta = 3$. At the tricritical point we observe $\alpha = 1/2$, $\beta = 1/4$, which are in accordance with the Landau free energy written in the even polynomial of order parameter. The observed value of exponent $\delta \approx 7$ at the tricritical point is the only exception which requires further detailed studies.

As an effect of the frustration, entropy of the ordered phase shall be enhanced compared with the ordered state that has the same spontaneous magnetization under $J_2 = 0$. We conjecture that this enhancement effect creates a minimum in the Landau free energy, which may be the reason of the first order transition we have observed here. The tricritical point is also present in the $(\infty, 4)$ lattice, which is nothing but the Bethe lattice. This suggests that the suppression of the loop back effect in the hyperbolic lattice is essential for the appearance of the tricritical behavior.

Determination of the phase diagram in the region $\kappa > 1/4$ is challenging because the ground state spin configuration becomes non-trivial as has been discussed in Section II. Because the $(5, 4)$ hyperbolic lattice consists of pentagons, the lattice does not decouple into sublattices even when $J_1 = 0$. For the study of this region, we have to modify the CTMRG algorithm in order to

treat ordered states with non-trivial spin patterns.

Acknowledgments

Slovak Agency for Science and Research grant APVV-51-003505 and Slovak VEGA grant No. 2/6101/27 are

acknowledged (A.G. and R.K.). This work is also partially supported by Grant-in-Aid for Scientific Research from Japanese Ministry of Education, Culture, Sports, Science and Technology (T.N. and A.G.). A.G. acknowledges the support of the Alexander von Humboldt foundation.

-
- [1] R. J. Baxter, *Exactly solved models in statistical mechanics* Academic Press, London (1982).
 - [2] F. Sausset and G. Tarjus *J. Phys. A: Math. Gen.* **40** 12873 (2007).
 - [3] J.C. Anglès d'Auriac, R. Mélin, P. Chandra and B. Douçot *J. Phys. A: Math. Gen.* **34** 675 (2001).
 - [4] R. Rietman, B. Nienhuis, and J. Oitmaa, *J. Phys. A* **25** 6577 (1992).
 - [5] B. Doyon and P. Fonseca *J. Stat. Mech.* P07002 (2004).
 - [6] H. Shima and Y. Sakaniwa, *J. Phys. A* **39** 4921(2006).
 - [7] I. Hasegawa, Y. Sakaniwa, and H. Shima, *Surface Science* **601** 5232 (2007).
 - [8] K. Ueda, R. Krčmar, A. Gendiar, and T. Nishino, *J. Phys. Soc. Jpn.* **76** 084004 (2007).
 - [9] R. Krčmar, A. Gendiar, K. Ueda, and T. Nishino, *J. Phys. A: Math. Theor.* **41** (2008) 125001.
 - [10] N. Anders and C. Chris Wu, *Combinatorics, Probability and Computing* **14** 523 (2005).
 - [11] C. Chris Wu, *J. Stat. Phys.* **100** 893 (2000).
 - [12] A. Gendiar, R. Krčmar, K Ueda, and T. Nishino, *Phys. Rev. E* **77** 041123 (2008).
 - [13] T. Nishino and K. Okunishi, *J. Phys. Soc. Jpn.* **65** 891 (1996).
 - [14] T. Nishino, K. Okunishi, and M. Kikuchi, *Phys. Lett. A* **213** 69 (1996).
 - [15] T. Nishino and K. Okunishi, *J. Phys. Soc. Jpn.* **66** 3040 (1997).
 - [16] S. R. White, *Phys. Rev. Lett.* **69** 2863 (1992).
 - [17] S. R. White, *Phys. Rev. B* **48** 10345 (1993).
 - [18] U. Schollwöck, *Rev. Mod. Phys.* **77** 259 (2005).
 - [19] I. Peschel, X. Wang, M. Kaulke, and K. Hallberg (Eds.), *Density-Matrix Renormalization, A New Numerical Method in Physics*, Lecture Notes in Physics (Springer, Berlin 1999).
 - [20] If n is multiple of 4, ferromagnetic-antiferromagnetic transition would be observed in the large κ region, which is outside the scope of this article.
 - [21] M. Suzuki and M. Katori, *J. Phys. Soc. Jpn.* **55** 1 (1986).
 - [22] T. Nishino, *J. Phys. Soc. Jpn.* **64** (1995) 3598.
 - [23] We keep $m = 40$ block spin states at most in the numerical calculations.